

High-Precision Low Voltage Detector

DESCRIPTION

BL8506 is a series of high precision voltage detector with ultra low current consumption (500nA typ. at V_{DD}=3.0V). It can work at very low voltage, which makes it perfect for system reset.

BL8506 is composed of high precision voltage reference, comparator, output driver and resistor array. Internally preset detect voltage has a low temperature drift and requires no external trimming.

Two type of output, CMOS and N-channel open-drain are available.

BL8506 is available in SOT-89-3, SOT-23-3, TO92, SOT23-5 packages which are Pb free.

FEATURES

- High-precision detection Voltage: $\pm 2\%$
- Detection Voltage: 0.9V~6.0V (in 0.1V steps)
- Precise hysteresis: 4% typ.
- Operating Voltage range: 0.7V~10V
- Ultra-low current consumption: 500nA typ. (at V_{DD}=3.0V)
- Two Output Forms : CMOS(Active Low) and N-channel open-drain(Active Low)

APPLICATIONS

- Power monitor for portable equipment such as PDA,DSC,Mobile phone,Notebook,MP3
- CPU and Logic Circuit Reset
- Battery Checker
- Battery Back-up Circuit
- Power Failure Detector

TYPICAL APPLICATION

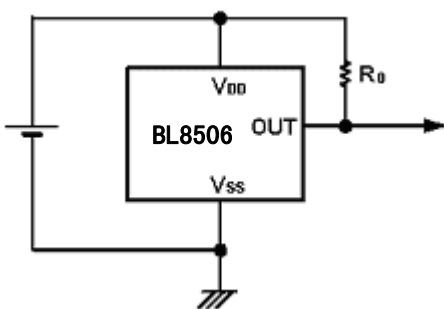

Note:

- R_o is unnecessary for CMOS output products.,
- The value of R_o need to be selected in different application, Typical value is 470k Ω

ELECTRICAL CHARACTERISTICS

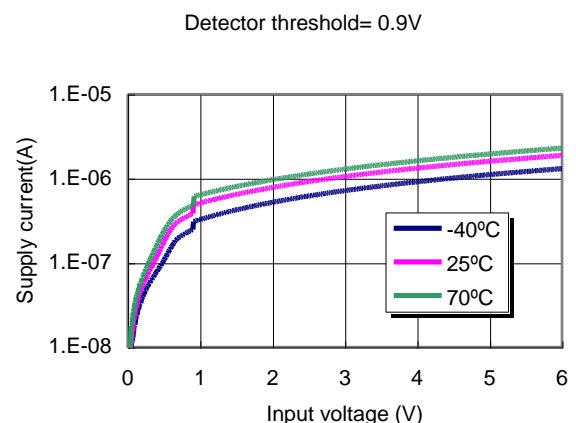

Selection Guide:

BL8506-XX X XX

Package Type:
 RM: SOT-23-3
 RN: SOT-23-5
 RO: SOT23
 SM: SOT-89-3
 T: TO-92
 (Default, Pb Free)

Output Type:
 N: Nch Open-drain
 C: CMOS

Detector Voltage:
 09.....0.9V
 30.....3.0V

 50.....5.0V
 60.....6.0V

Pin Assignment:

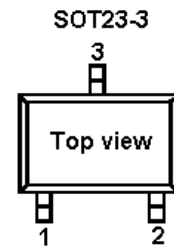
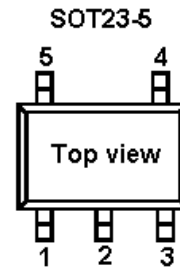
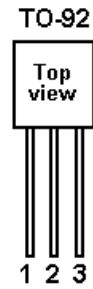

Pin Description:

PIN Number				PIN Name	Function
SOT-89-3	TO-92	SOT-23-3/SOT23	SOT-23-5		
1	3	1	1	VOUT	Voltage detection output Pin
2	1	3	2	VDD	Voltage input Pin
3	2	2	3	VSS	GND Pin
—	—	—	4	NC	No connection
—	—	—	5	NC	No connection

BL8506

Product Classification:

<i>Product Name</i>	<i>Detector Voltage</i>	Output Type	Package
BL8506-XXNRM	XX V	Nch Open-Drain	SOT-23-3
BL8506-XXNRN	XX V	Nch Open-Drain	SOT-23-5
BL8506-XXNRO	XX V	Nch Open-Drain	SOT-23
BL8506-XXNSM	XX V	Nch Open-Drain	SOT-89-3
BL8506-XXNT	XX V	Nch Open-Drain	TO-92
BL8506-XXCRM	XX V	CMOS	SOT-23-3
BL8506-XXCRN	XX V	CMOS	SOT-23-5
BL8506-XXCRO	XX V	CMOS	SOT-23
BL8506-XXCSM	XX V	CMOS	SOT-89-3
BL8506-XXCT	XX V	CMOS	TO-92

Product Mark Information:

Product NO.	Mark
BL8506-09CSM	8506 09CXX
BL8506-20CT	8506 20CXX
BL8506-27CSM	8506 27CXX
BL8506-30CT	8506 30CXX
.....
BL8506-09NRM	N609
BL8506-11NRO	N611
BL8506-21NRN	N621
BL8506-27CRM	C627
BL8506-30CRM	C630
.....

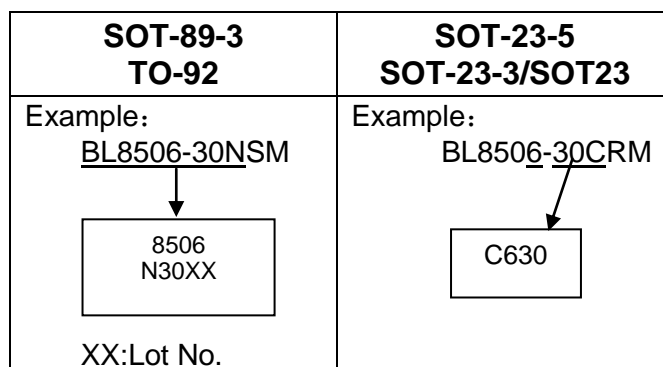

ABSOLUTE MAXIMUM RATING

Parameter		Value
Input Voltage		-0.3V-10V
Output Voltage range		-0.3V-12V
Maximum Output current		70mA
Ambient Temperature(Ta)		-40°C -85°C
Power Dissipation	SOT-23-3	250mW
	SOT-23-5	250mW
	SOT-89-3	500mW
	TO-92	600mW
Storage Temperature(Ts)		-40°C -150°C
Lead Temperature & Time		260°C,10S

Note:

Exceed these limits to damage to the device.

Exposure to absolute maximum rating conditions may affect device reliability

RECOMMENDED WORK CONDITIONS

Item	Min	Recommended	Max.	Unit
Input Voltage Range	0.7		10	V
Ambient Temperature	-40	25	85	°C

ELECTRICAL CHARACTERISTICS

BL8506CXXTR09C/N (0.9V)

(Topt=25°C, Unless otherwise specified.)

Symbol	Parameter	Conditions	Reference data			Unit
			Min.	Typ.	Max.	
-VDET	Detector Threshold		0.882	0.9	0.918	V
VHYS	Detector Threshold Hysteresis		0.018	0.036	0.054	V
ISS	Current consumption	VDD=2.9V		1	2.5	uA
VDDH	Maximum operating voltage				10	V
VDDL	Minimum Operating voltage			0.5		V
IOUT	Output current	Nch VDS=0.05V, VDD=0.7V VDS=0.50V, VDD=0.8V	0.01 0.05	0.05 0.50		mA
		Pch VDS=-2.1V, VDD=4.50V	1.0	2.0		mA
TPLH	Output Delay Time				20	uS

BL8506

BL8506CXXTR25C/N (2.5V)

(T_{opt}=25°C, Unless otherwise specified.)

Symbol	Parameter	Conditions	Reference data			Unit
			Min.	Typ.	Max.	
-VDET	Detector Threshold		2.450	2.5	2.550	V
VHYS	Detector Threshold Hysteresis		0.050	0.100	0.150	V
ISS	Current consumption	VDD=4.5V		1	2.5	uA
VDDH	Maximum operating voltage				10	V
VDDL	Minimum Operating voltage			0.5		V
IOUT	Output current	Nch VDS=0.05V, VDD=0.70V	0.01	0.05		mA
		Pch VDS=-2.1V, VDD=4.50V	1.0	2.0		mA
TPLH	Output Delay Time				20	uS

BL8506CXXTR27C/N (2.7V)

(T_{opt}=25°C, Unless otherwise specified.)

Symbol	Parameter	Conditions	Reference data			Unit
			Min.	Typ.	Max.	
-VDET	Detector Threshold		2.646	2.7	2.754	V
VHYS	Detector Threshold Hysteresis		0.054	0.108	0.162	V
ISS	Current consumption	VDD=4.7V		1	2.5	uA
VDDH	Maximum operating voltage				10	V
VDDL	Minimum Operating voltage			0.5		V
IOUT	Output current	Nch VDS=0.05V, VDD=0.70V	0.01	0.05		mA
		Pch VDS=-2.1V, VDD=4.50V	1.0	2.0		mA
TPLH	Output Delay Time				20	uS

BL8506CXXTR30C/N (3.0V)

(T_{opt}=25°C, Unless otherwise specified.)

Symbol	Parameter	Conditions	Reference data			Unit
			Min.	Typ.	Max.	
-VDET	Detector Threshold		2.94	3.0	3.06	V
VHYS	Detector Threshold Hysteresis		0.060	0.12	0.18	V
ISS	Current consumption	VDD=5.0V		1	2.5	uA
VDDH	Maximum operating voltage				10	V
VDDL	Minimum Operating voltage			0.5		V
IOUT	Output current	Nch VDS=0.05V, VDD=0.7V	0.01	0.05		mA
		Pch VDS=-2.1V, VDD=4.50V	1.0	2.0		mA
TPLH	Output Delay Time				20	uS

BL8506

BL8506CXXTR34C/N (3.4V)

(T_{opt}=25°C, Unless otherwise specified.)

Symbol	Parameter	Conditions	Reference data			Unit
			Min.	Typ.	Max.	
-VDET	Detector Threshold		3.332	3.4	3.468	V
VHYS	Detector Threshold Hysteresis		0.068	0.136	0.204	V
ISS	Current consumption	VDD=5.0V		1	2.5	uA
VDDH	Maximum operating voltage				10	V
VDDL	Minimum Operating voltage			0.5		V
IOUT	Output current	Nch VDS=0.05V, VDD=0.7V	0.01	0.05		mA
		Pch VDS=-2.1V, VDD=4.50V	1.0	2.0		mA
TPLH	Output Delay Time				20	uS

BL8506CXXTR44C/N (4.4V)

(T_{opt}=25°C, Unless otherwise specified.)

Symbol	Parameter	Conditions	Reference data			Unit
			Min.	Typ.	Max.	
-VDET	Detector Threshold		4.312	4.4	4.488	V
VHYS	Detector Threshold Hysteresis		0.088	0.176	0.264	V
ISS	Current consumption	VDD=6.4V		1	2.5	uA
VDDH	Maximum operating voltage				10	V
VDDL	Minimum Operating voltage			0.5		V
IOUT	Output current	Nch VDS=0.05V, VDD=0.7V	0.01	0.05		mA
		Pch VDS=-2.1V, VDD=8.0V	1.5	3.0		mA
TPLH	Output Delay Time				20	uS

Electrical Characteristics By Detector Threshold

Part Number	Detector Threshold			Detector Threshold Hysteresis			Supply Current1			Supply Current2				
	-Vdet[V]			Vhys[V]			Iss1[μ A]			Iss2[μ A]				
	Min.	Typ.	Max.	Min.	Typ.	Max.	Condition	Typ.	Max.	Condition	Typ.	Max.		
BL8506CXXTR09C/N	0.882	0.900	0.918	0.018	0.036	0.054	Vdd= (-Vdet) +0.1V	0.5	2.5	Vdd= (-Vdet) +2V	1.0	2.5		
BL8506CXXTR10C/N	0.980	1.000	1.020	0.020	0.040	0.060								
BL8506CXXTR11C/N	1.078	1.100	1.122	0.022	0.044	0.066								
BL8506CXXTR12C/N	1.176	1.200	1.224	0.024	0.048	0.072								
BL8506CXXTR13C/N	1.274	1.300	1.326	0.026	0.052	0.078								
BL8506CXXTR14C/N	1.372	1.400	1.428	0.028	0.056	0.084								
BL8506CXXTR15C/N	1.470	1.500	1.530	0.030	0.060	0.090								
BL8506CXXTR16C/N	1.568	1.600	1.632	0.032	0.064	0.096								
BL8506CXXTR17C/N	1.666	1.700	1.734	0.034	0.068	0.102								
BL8506CXXTR18C/N	1.764	1.800	1.836	0.036	0.072	0.108								
BL8506CXXTR19C/N	1.862	1.900	1.938	0.038	0.076	0.114								
BL8506CXXTR20C/N	1.960	2.000	2.040	0.040	0.080	0.120								
BL8506CXXTR21C/N	2.058	2.100	2.142	0.042	0.084	0.126								
BL8506CXXTR22C/N	2.156	2.200	2.244	0.044	0.088	0.132								
BL8506CXXTR23C/N	2.254	2.300	2.346	0.046	0.092	0.138								
BL8506CXXTR24C/N	2.352	2.400	2.448	0.048	0.096	0.144								
BL8506CXXTR25C/N	2.450	2.500	2.550	0.050	0.100	0.150								
BL8506CXXTR26C/N	2.548	2.600	2.652	0.052	0.104	0.156								
BL8506CXXTR27C/N	2.646	2.700	2.754	0.054	0.108	0.162								
BL8506CXXTR28C/N	2.744	2.800	2.856	0.056	0.112	0.168								
BL8506CXXTR29C/N	2.842	2.900	2.958	0.058	0.116	0.174								
BL8506CXXTR30C/N	2.940	3.000	3.060	0.060	0.120	0.180								
BL8506CXXTR31C/N	3.038	3.100	3.162	0.062	0.124	0.186								
BL8506CXXTR32C/N	3.136	3.200	3.264	0.064	0.128	0.192								
BL8506CXXTR33C/N	3.234	3.300	3.366	0.066	0.132	0.198								
BL8506CXXTR34C/N	3.332	3.400	3.468	0.068	0.136	0.204								
BL8506CXXTR35C/N	3.430	3.500	3.570	0.070	0.140	0.210								
BL8506CXXTR36C/N	3.528	3.600	3.672	0.072	0.144	0.216								
BL8506CXXTR37C/N	3.626	3.700	3.774	0.074	0.148	0.222								
BL8506CXXTR38C/N	3.724	3.800	3.876	0.076	0.152	0.228								
BL8506CXXTR39C/N	3.822	3.900	3.978	0.078	0.156	0.234								
BL8506CXXTR40C/N	3.920	4.000	4.080	0.080	0.160	0.240								
BL8506CXXTR41C/N	4.018	4.100	4.182	0.082	0.164	0.246								
BL8506CXXTR42C/N	4.116	4.200	4.284	0.084	0.168	0.252								
BL8506CXXTR43C/N	4.214	4.300	4.386	0.086	0.172	0.258								
BL8506CXXTR44C/N	4.312	4.400	4.488	0.088	0.176	0.264								
BL8506CXXTR45C/N	4.410	4.500	4.590	0.090	0.180	0.270								
BL8506CXXTR46C/N	4.508	4.600	4.692	0.092	0.184	0.276								
BL8506CXXTR47C/N	4.606	4.700	4.794	0.094	0.188	0.282								
BL8506CXXTR48C/N	4.704	4.800	4.896	0.096	0.192	0.288								
BL8506CXXTR49C/N	4.802	4.900	4.998	0.098	0.196	0.294								
BL8506CXXTR50C/N	4.900	5.000	5.100	0.100	0.200	0.300								
BL8506CXXTR51C/N	4.998	5.100	5.202	0.102	0.204	0.306								
BL8506CXXTR52C/N	5.096	5.200	5.304	0.104	0.208	0.312								
BL8506CXXTR53C/N	5.194	5.300	5.406	0.106	0.212	0.318								
BL8506CXXTR54C/N	5.292	5.400	5.508	0.108	0.216	0.324								
BL8506CXXTR55C/N	5.390	5.500	5.610	0.110	0.220	0.330								
BL8506CXXTR56C/N	5.488	5.600	5.712	0.112	0.224	0.336								
BL8506CXXTR57C/N	5.586	5.700	5.814	0.114	0.228	0.342								
BL8506CXXTR58C/N	5.684	5.800	5.916	0.116	0.232	0.348								
BL8506CXXTR59C/N	5.782	5.900	6.018	0.118	0.236	0.354								
BL8506CXXTR60C/N	5.880	6.000	6.120	0.120	0.240	0.360								
													0.5	2.5

BL8506

Output Current1			Output Current2				Output Delay Time	Minimum Operating Voltage		Detector Threshold Temperature Coefficient	
Iout1[mA]			Iout2[mA]				TPLH[us]	VDDL[V]		-VDET/ Tppm/°C	
Condition	Min.	Typ.	Condition		Min.	Typ.	Max.	Typ.	Max.	Condition	Typ.
NCH, V _{DS} =0.05V , V _{DD} =0.7V	0.01	0.05	NCH, V _{DS} =0.5V	V _{DD} =0.85V	0.1	0.5	20	0.5	0.7	-40°C -85°C	100
				V _{DD} =1.0V	0.2	1.0					
				V _{DD} =1.5V	1.0	2.0					

BLOCK DIAGRAM

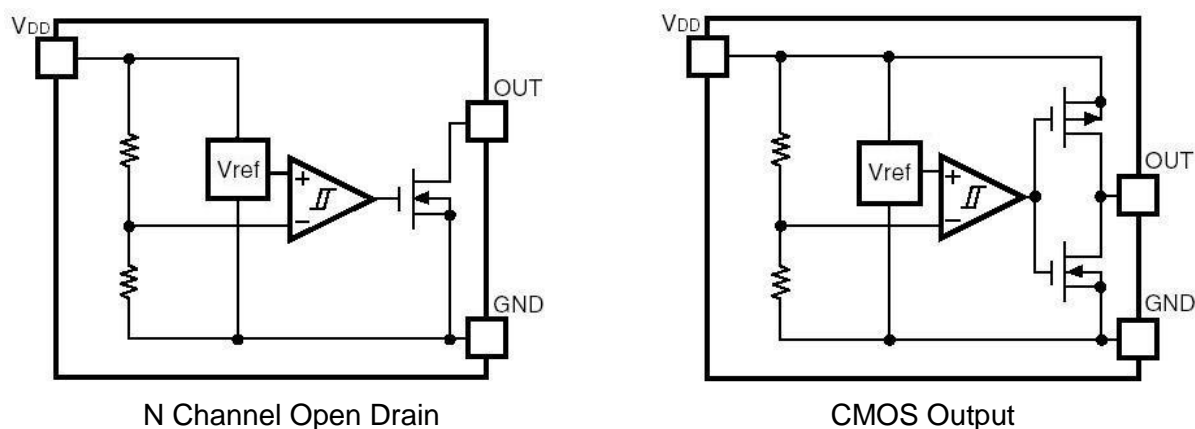

FUNCTION DESCRIPTION

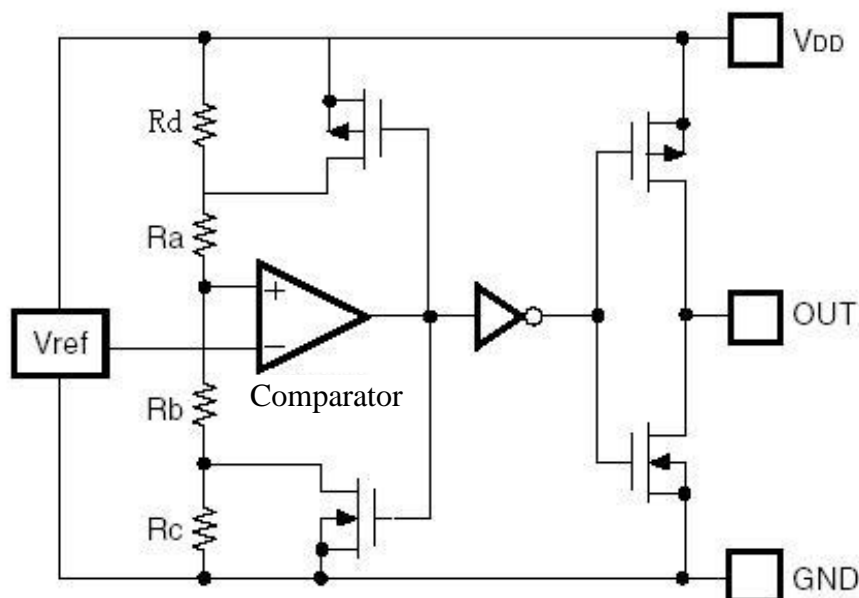

High precision low temperature co-efficiency reference voltage is applied to the negative input of a comparator. Input voltage, divided by resistor array of Ra Rb and Rc, is applied to the positive input of the comparator. Output of the comparator controls a pair of NMOS and PMOS switches, generating the hysteresis. Output of the comparator passes a series of buffer to drive the output CMOS pair.

+ V_{DET} , - V_{DET} , V_{HYS} can be calculated as follows:

$$- V_{DET} = V_{REF} * (1 + R_a / (R_b + R_c))$$

$$+ V_{DET} = V_{REF} * (1 + (R_a + R_d) / R_b) = V_{REF} * (1 + (R_a + R_c) / R_b)$$

$$V_{HYS} = + V_{DET} - (- V_{DET}) = V_{REF} * (R_a + R_b + R_c) * (1 / R_b - 1 / (R_b + R_c))$$

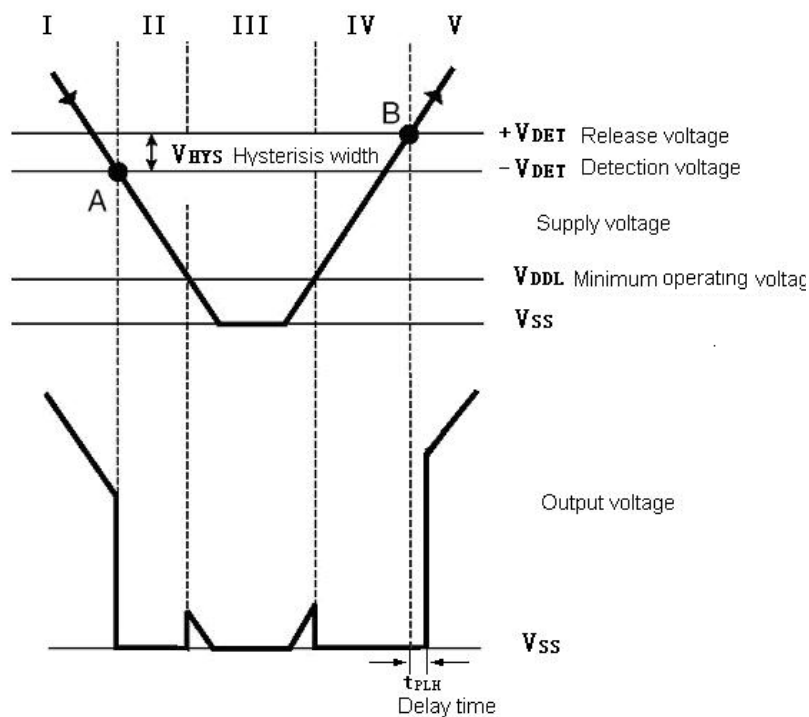

No.	Operation status	Output status
I	VDD > -VDET	Output voltage is equal to the supply voltage
II	VDD drops below -VDET	Output voltage equals to GND level
III	VDD drops further below VDDL	Output voltage is undefined
IV	VDD rises above VDDL	Output voltage equals to GND level
V	VDD rises above +VDET	Output voltage equals to supply voltage, VHYS=(+VDET)-(-VDET)

TEST CIRCUITS

(1) Supply current test circuit

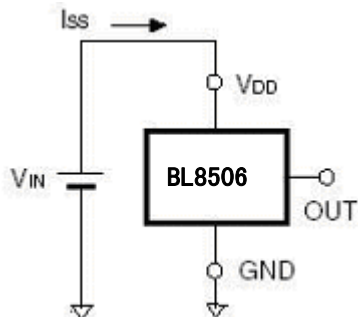

(2) Detector threshold test circuit

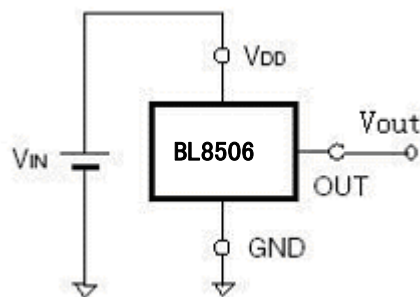

(3) NCH Drive Output Current Test Circuit

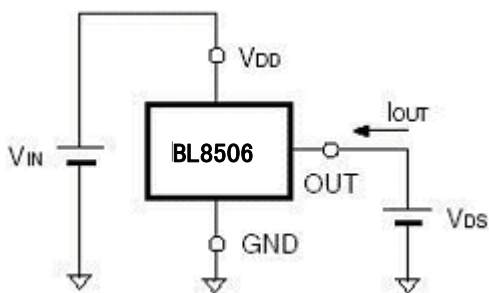

(4) PCH Drive Output Current Test Circuit

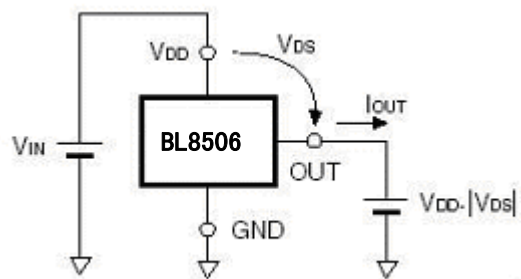

TYPICAL PERFORMANCE CHARACTERISTICS

1) Output voltage VS. Input voltage

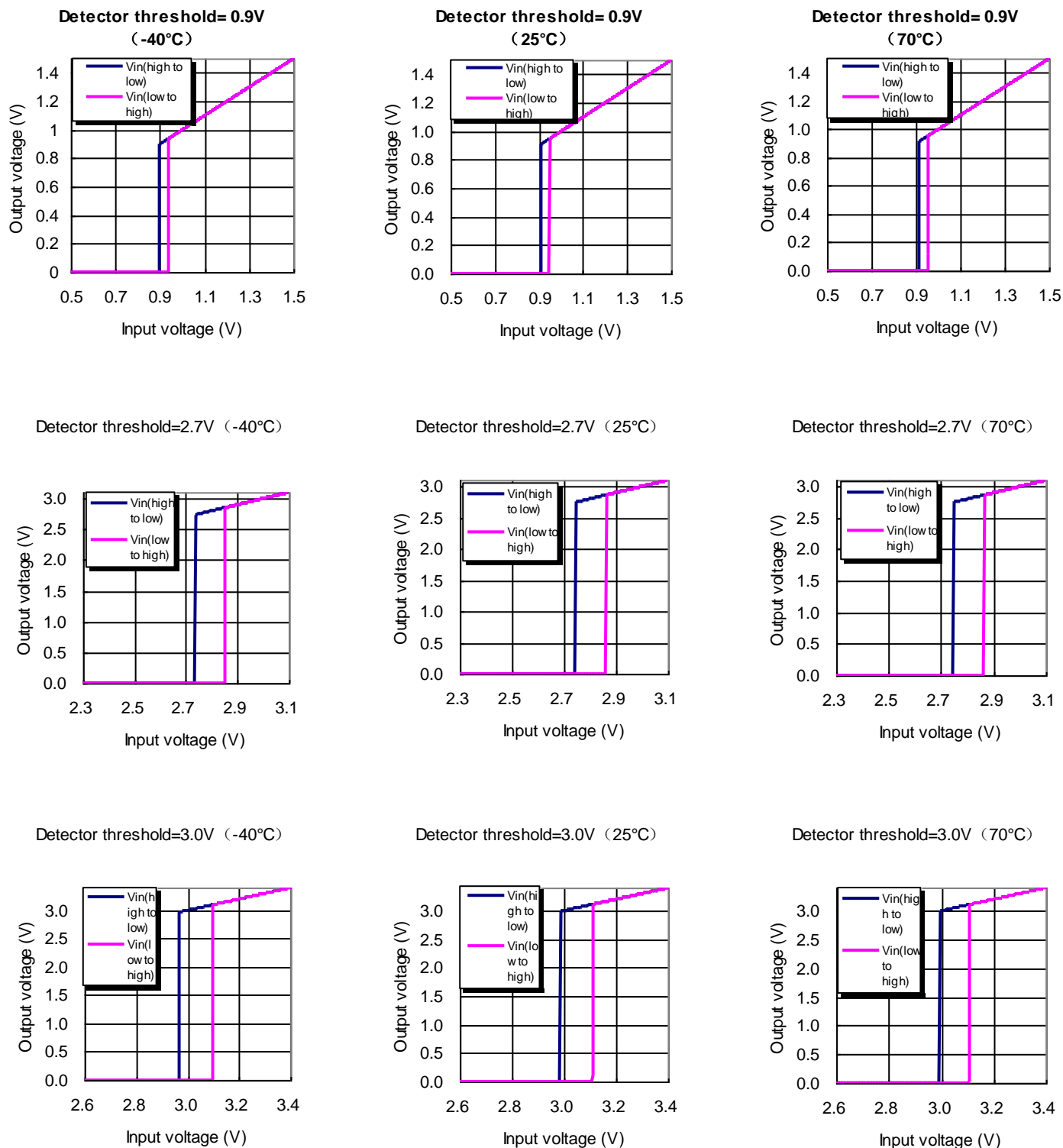

Detector threshold=4.4V (-40°C)

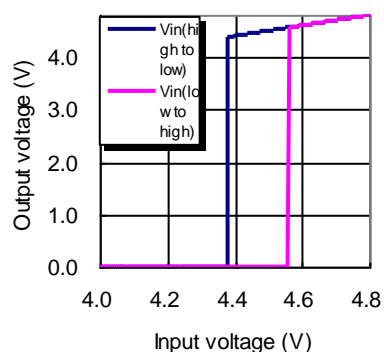

Detector threshold=4.4V (25°C)

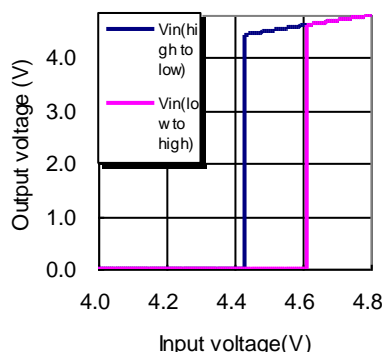

Detector threshold=4.4V (70°C)

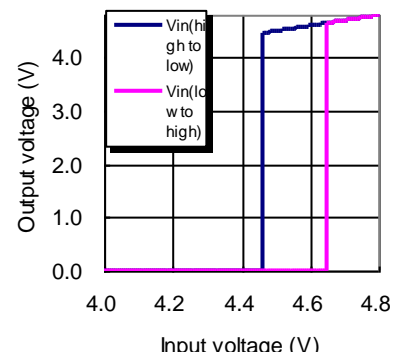

2) Supply current VS. Input voltage

Detector threshold=0.9V

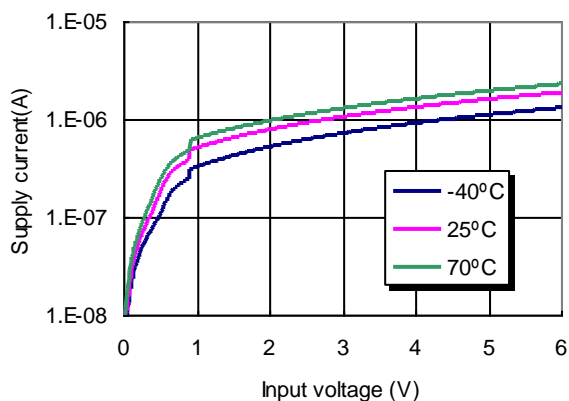

Detector threshold=2.7V

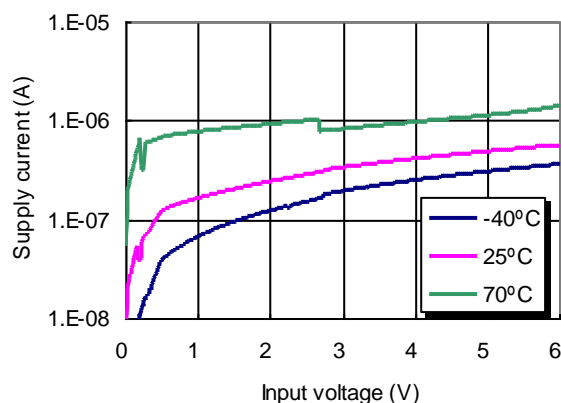

Detector threshold=3.0V

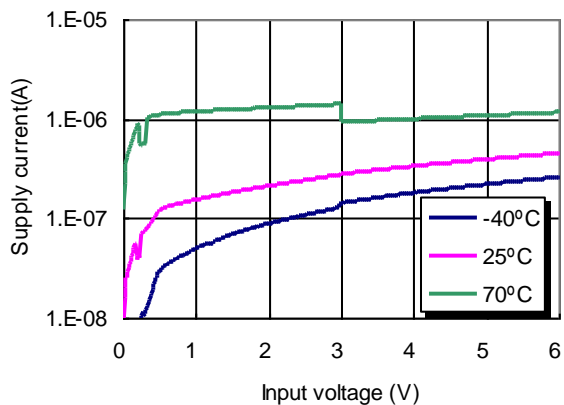

Detector threshold=4.4V

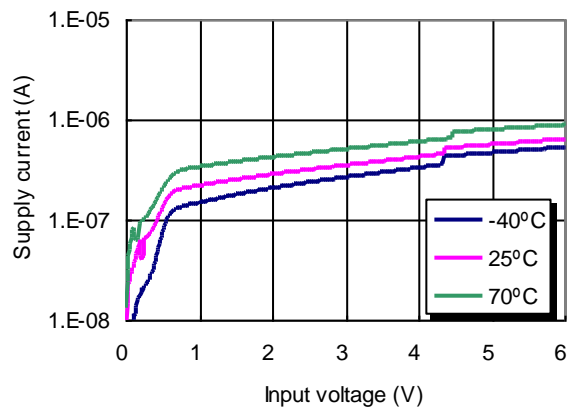

3) Detector Threshold Hysteresis VS. Temperature

Detector threshold= 0.9V

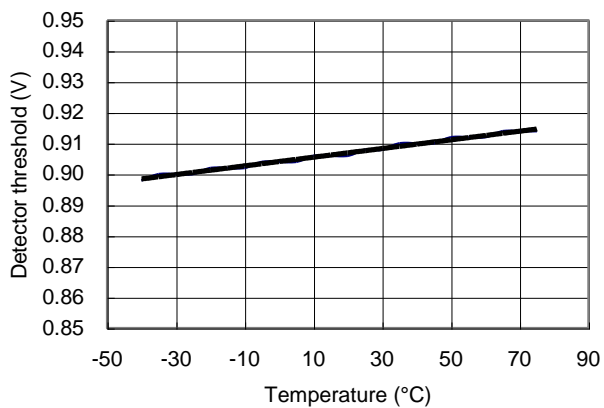

Detector threshold=2.7V

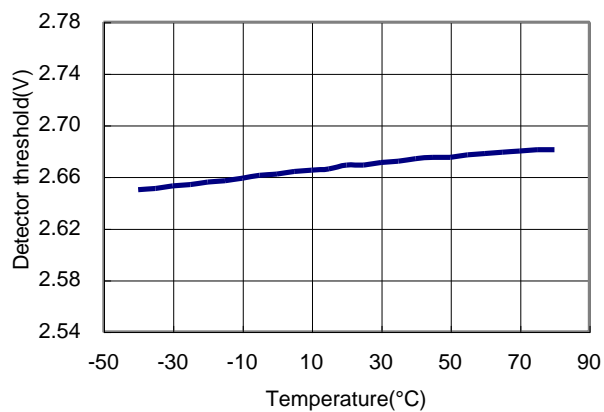

Detector threshold=3.0V

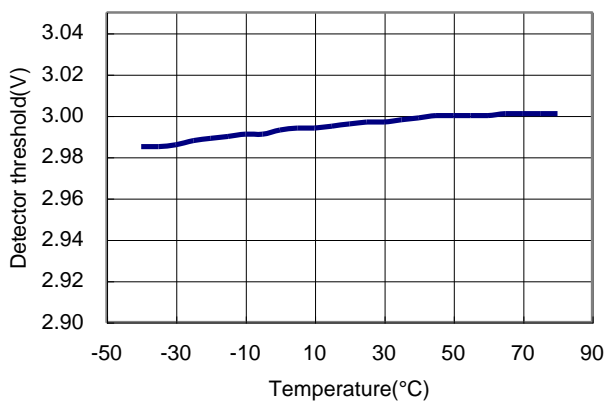

Detector threshold=4.4V

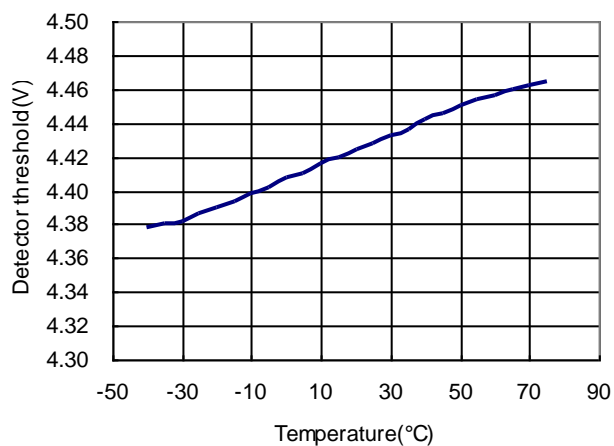

4) Nch Driver Output Current VS. V_{DS}

BL8506-09CXX

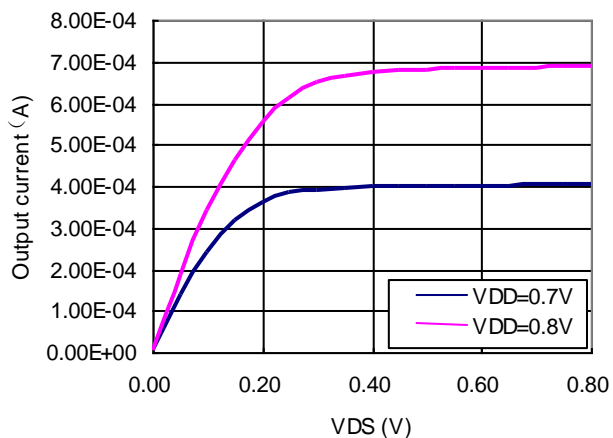

BL8506-27CXX

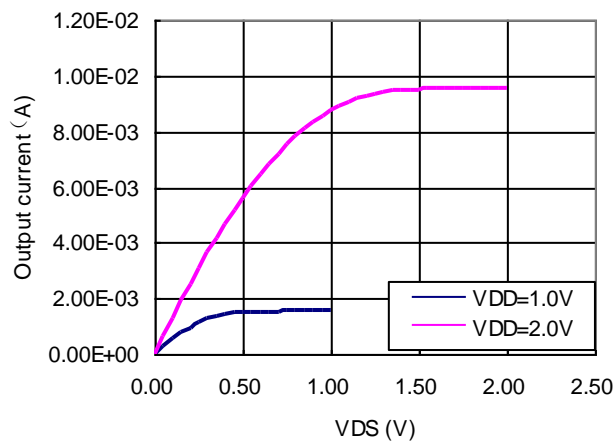

BL8506-30CXX

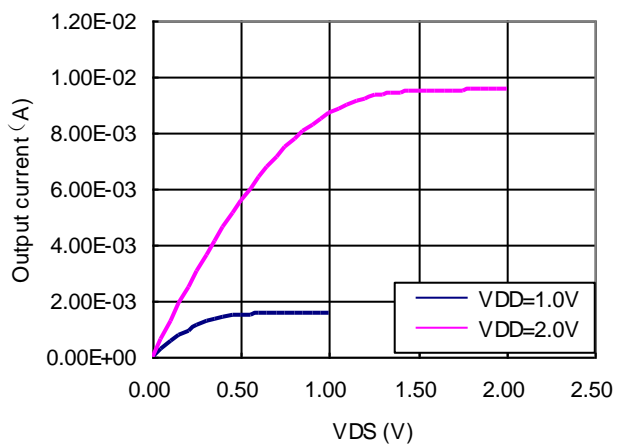

BL8506-44CXX

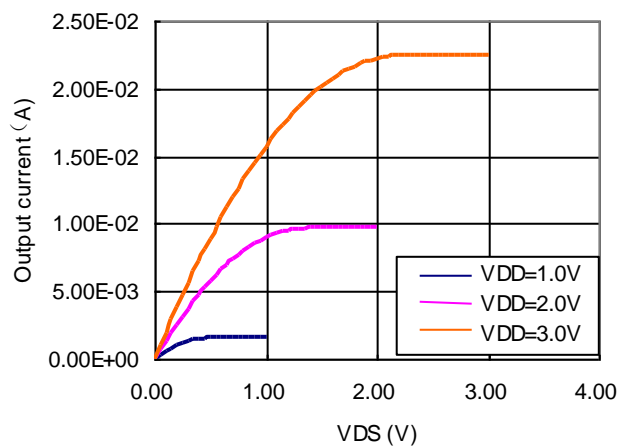

5) NCH Driver Output Current vs. Input Voltage

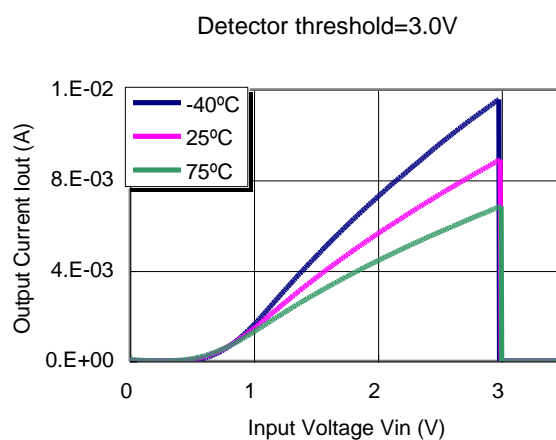
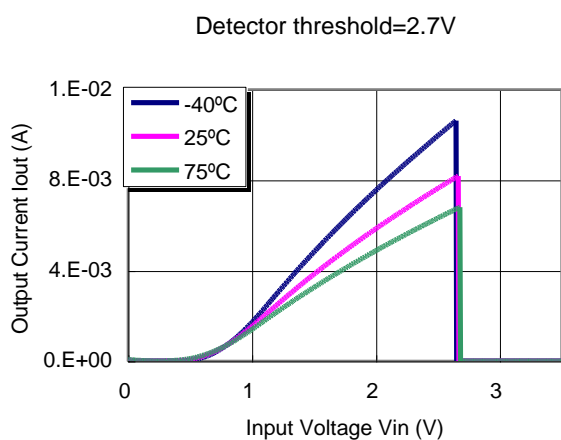

6) PCH Driver Output Current vs. Input Current

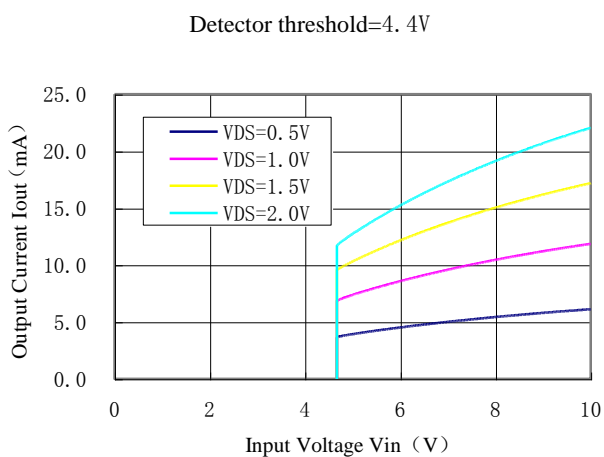
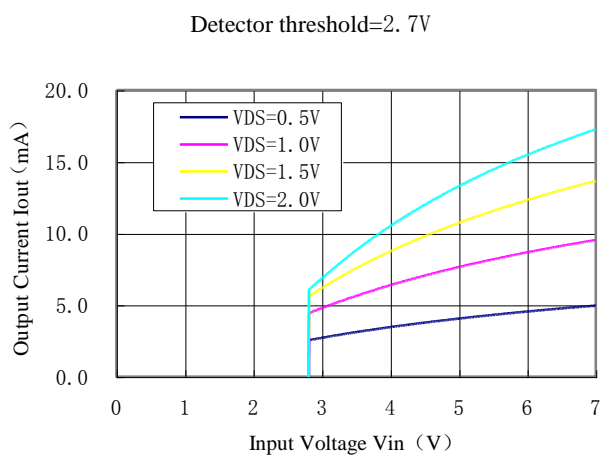
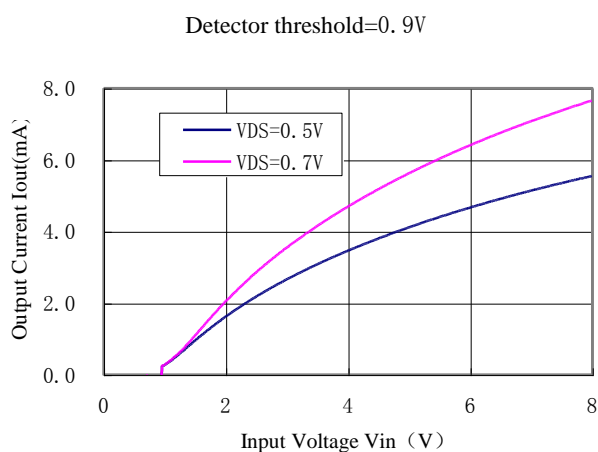

PACKAGE LINE

Package	SOT-23-3	Devices per reel	3000Pcs	Unit	mm
Package dimension:					
<p>Technical drawing of the SOT-23-3 package. The top view shows a rectangular body with a width of 2.9 ± 0.2 mm and a length of 1.9 ± 0.2 mm. The distance between the two leads is 1.9 ± 0.2 mm, with each lead offset by (0.95) mm from the center. The lead width is 0.4 ± 0.1 mm. The body height is 1.6 ± 0.2 mm, and the total height including the lead is 2.8 ± 0.3 mm. The lead height is 0.8 mm. The side view shows a lead height of 1.1 mm with a tolerance of $+0.2$ to -0.1 mm, and a lead thickness of 0.16 mm with a tolerance of $+0.1$ to -0.06 mm. The lead length is 1.4 mm maximum. The lead angle is 0 to 0.1 degrees. The lead thickness is 0.2 mm minimum. The perspective view shows the package from an isometric angle.</p>					

Package	SOT-23-5	Devices per reel	3000Pcs	Unit	mm
Package Dimension:					
<p>Technical drawing of the SOT-23-5 package. The top view shows a rectangular body with a width of 2.9 ± 0.2 mm and a length of 1.9 ± 0.2 mm. The distance between the two leads is 1.9 ± 0.2 mm, with each lead offset by (0.95) mm from the center. The lead width is 0.4 ± 0.1 mm. The body height is 1.6 mm with a tolerance of $+0.2$ to -0.1 mm, and the total height including the lead is 2.8 ± 0.3 mm. The lead height is 0.8 ± 0.1 mm. The side view shows a lead height of 1.1 mm with a tolerance of $+0.2$ to -0.1 mm, and a lead thickness of 0.15 mm with a tolerance of $+0.1$ to -0.05 mm. The lead length is 1.4 mm maximum. The lead angle is 0 to 0.1 degrees. The lead thickness is 0.2 mm minimum. The perspective view shows the package from an isometric angle.</p>					

BL8506

Package	SOT-89-3	Devices per reel	1000Pcs	Unit	mm
---------	----------	------------------	---------	------	----

Package Dimension:

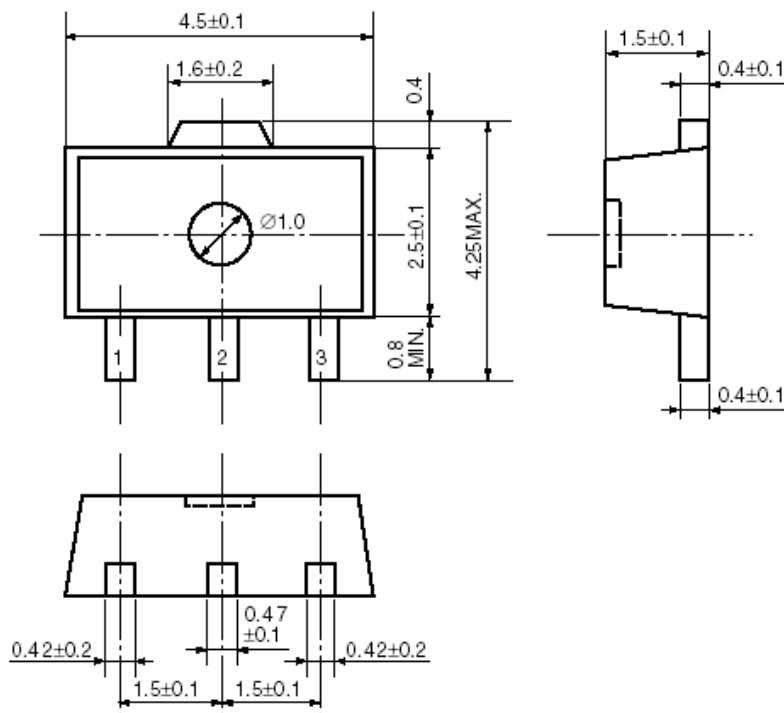

Package	TO-92	Devices per Bag	1000Pcs	Unit	mm
<p>Package Dimension:</p> <p style="text-align: center;">TO-92</p> <p>The drawing shows two views of a TO-92 package. The top view is a semi-circle with a diameter of $\Phi 1.5 \pm 0.2$ mm. The width of the top flat section is 2.54 mm. The total height from the top flat surface to the bottom of the semi-circle is 3.5 ± 0.1 mm. The height of the top flat section is 1.25 ± 0.1 mm. The thickness of the top flat section is 0.38 mm. The side view shows a cylindrical body with a diameter of $\Phi 4.5 \pm 0.1$ mm and a height of 4.95 ± 0.35 mm. The distance from the top of the cylindrical body to the top of the lead wire is 0.46 mm. The lead wire has a diameter of 0.5 mm and a length of 14.3 mm. The lead wire is bent at a 5-degree angle. The distance from the top of the cylindrical body to the bottom of the lead wire is 1.5 mm. The distance from the top of the cylindrical body to the top of the lead wire is 0.38 mm.</p>					

X-ON Electronics

Largest Supplier of Electrical and Electronic Components

Click to view similar products for [Supervisory Circuits](#) category:

Click to view products by [Belling](#) manufacturer:

Other Similar products are found below :

[CAT1161LI-25-G](#) [CAT853STBI-T3](#) [TC54VN2402EMB713](#) [MCP1316T-44NE/OT](#) [MCP1316MT-45GE/OT](#) [MCP1316MT-23LI/OT](#)
[DS1232L](#) [NCV302HSN45T1G](#) [MCP1316T-23LI/OT](#) [PT7M6130NLTA3EX](#) [S-1000N28-I4T1U](#) [CAT1161LI-28-G](#) [MCP1321T-29AE/OT](#)
[MCP1319MT-47QE/OT](#) [S-1000N23-I4T1U](#) [S-1000N19-I4T1U](#) [CAT824UTDI-GT3](#) [TC54VC2502ECB713](#) [PT7M6133NLTA3EX](#)
[PT7M6127NLTA3EX](#) [BD48E23G-TR](#) [BD48E49G-TR](#) [BD48E52G-TR](#) [MP6412GQGU-Z](#) [XC61GN2502HR-G](#) [HG810RM3/TR](#)
[ME2808A33XG](#) [ME2801A33M3G](#) [SGM809B-RXN3LG/TR](#) [HT7033S](#) [UM803RS](#) [UM805RE](#) [BL8506-40CRM](#) [SSP54123](#)
[SSP61CN1902MR](#) [Aip54123](#) [MAX809C263NR](#) [HE61CN2402MR](#) [UM810MS](#) [MAX809C293NR](#) [MAX809C308NR](#) [HE61CN2702MR](#)
[UM811SE](#) [XC61CN1902MR](#) [BD48K34G-TL](#) [BL8506-20CRM](#) [CN825R](#) [XC61CC1502MR](#) [XC61CN1802MR](#) [BL8509CCB3TR263DC](#)