



Features

- Surface Mounting Design 7.8×5.0×5.0mm
- High Current Handling Capability 5,000A @ 8/20μ s
- Low Capacitance and Insertion Loss
- Quick Response and Long Service Life
- Moisture sensitivity level: Level 1

Application Information

- DC30V Power

Agency Approvals

Icon	Description
RoHS	Compliance with 2011/65/EU
HF	Compliance with IEC61249-2-21:2003
	Mean lead free
	UL Certificated E232249

Exterior



SMD

Package (Top View)

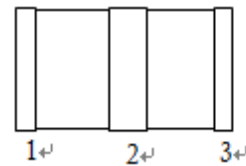

Schematic Symbol

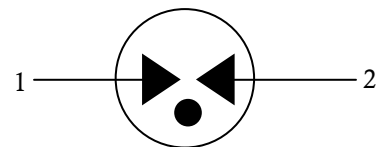

Electrical Parameter

DC Breakdown Voltage ¹⁾²⁾	100V/s	420-780	V
Impulse Spark-over Voltage	At 1kV/μs	for 99 % of measured values ≤1200	V
Impulse Discharge Current ³⁾	8/20μs, ±5T	5,000	A
	10/350μs, ±1T	1,000	A
	10/1000 μ s ± 150 times	200	A
Arc Voltage	At 1A	>33	V
	CPK	>1.33	
Insulation Resistance	DC=100V	≥1	GΩ
Capacitance at 1MHz	VDC=0.5V	≤1.5	pF
Weight		~1	g
Operating And Storage Temperature		-40-90	°C
Marking		Without	

1) At delivery AQL 0.65 level II ISO 2859

2) In ionized mode

3) Terms and waveforms in accordance with ITU-T Rec. K. 12; IEC 61643-21

Gas Discharge Tube

Version: A1 2018-12-20

Part Numbering System

B3D 350 M - R-1

(1) (2) (3)

(1) Bencent 3-Electrode SMD Gas Discharge Tube

7.8×5.0×5.0mm

(2) DC Breakdown Voltage, e.g., 350=350V

(3) Surge Rating @8/20μ s, M=5,000A

Product Characteristics

Lead Material	Copper
Body Material	Ceramics
Terminal Finish	100% Matte-Tin Plated

Environmental Reliability Characteristics

Testing items	Technical standards
High Temperature Storage Test	Temperature: 90°C Time: 2H
Low Temperature Storage Test	Temperature: -40°C Time: 2H
Vibration	Frequency: 10-500Hz Amplitude: 0.15mm Time: 45min
Resistance of soldering heat	Temperature: 260±5°C Time of dip soldering: 10s, 1time

Note: Up-screen program can be specified by customer's request via contacting Bencent service

Solderability Test

Solderability	Solder Pot Temperature:	OO245°C ± 5°C
	Solder Dwell Time:	4-6 secs.

Product Dimensions

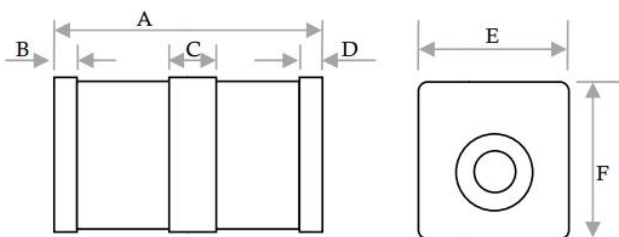

Coplanarity ≤ 0.15mm

REF	mm	inch
A	7.8±0.3	0.307±0.012
B	0.5±0.2	0.020±0.008
C	1.6±0.2	0.063±0.008
D	0.5±0.2	0.020±0.008
E	5.0±0.2	0.197±0.008
F	5.0±0.2	0.197±0.008

Recommended Soldering Pad

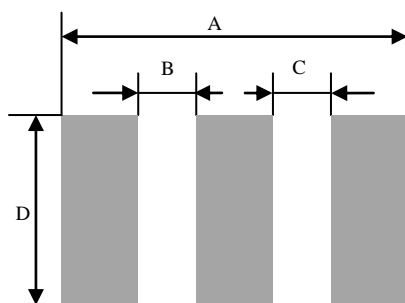

REF	mm	inch
A	9.6	0.378
B	1.5	0.059
C	1.5	0.059
D	5.0	0.197

Reflow Profile

Reflow Condition		Pb-Free assembly
Pre Heat	Temperature Min	150 °C
	Temperature Max	200 °C
	Time (min to max)	60 – 180 secs.
Average ramp up rate (Liquids) T _{amp} (T _L) to peak		3 °C/second max
T _S (max) to T _L - Ramp-up Rate		3 °C/second max
Reflow	- Temperature (T _L) (Liquids)	217 °C
	- Temperature (T _L)	60 – 150 secs.
Peak Temperature (T _P)		260±0/-5 °C
Time within 5 °C of actual peak Temperature (t _p)		~10 secs
Ramp-down Rate		6 °C/secs. max
Time 25 °C to peak Temperature (T _P)		8 minutes Max.
Do not exceed		260 °C

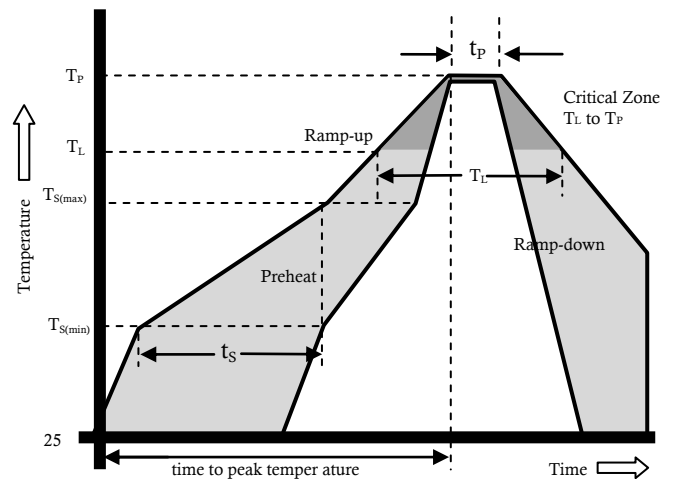

Remarking: it's only suitable for SMT manufacture, not for manual welding.

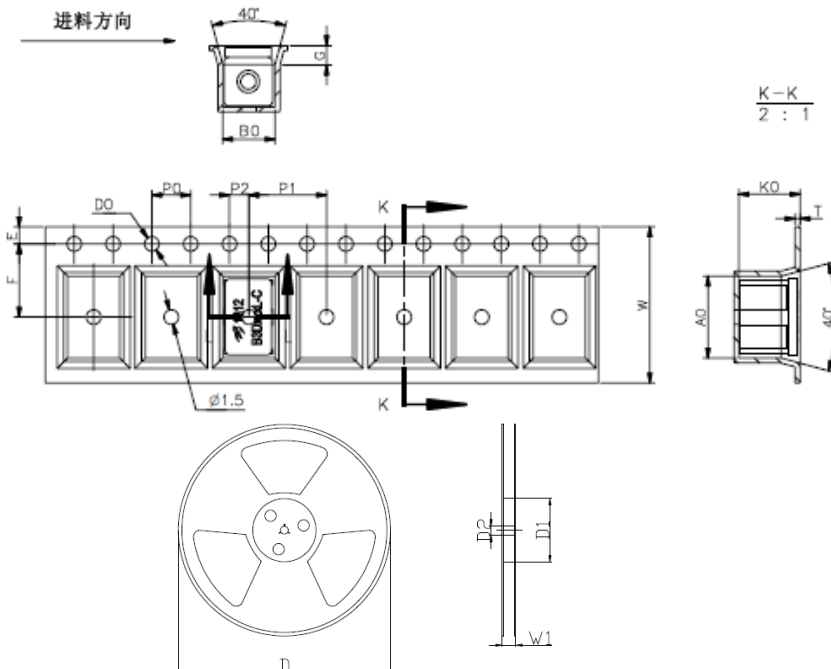
Package Reel Information

REF	mm	inch
A0	8.4±0.2	0.331±0.008
B0	5.4±0.2	0.216±0.008
P0	4.0±0.2	0.157±0.008
P1	8.0±0.2	0.315±0.008
P2	2.0±0.2	0.079±0.008
E	1.75±0.2	0.069±0.008
F	7.5±0.2	0.295±0.008
K0	6.3±0.2	0.248±0.008
T	0.5±0.2	0.020±0.008
G	2	0.079
D0	Φ 1.5±0.2	Φ 0.059±0.008
W	16.0±0.3	0.630± 0.012
D	Φ 330.0	Φ 13.0
D1	Φ 50Min	Φ 1.97Min
D2	Φ 13±0.5	Φ 0.512±0.020
W1	16.8±0.5	0.661±0.020

Outline	Reel (PCS)	Per Carton (PCS)	Reel Diameter (mm)	Carton Size(mm)		
				L	W	H
TAPING	1,000	16,000	330	360	360	385

X-ON Electronics

Largest Supplier of Electrical and Electronic Components

Click to view similar products for [Gas Discharge Tubes - GDTs / Gas Plasma Arrestors](#) category:

Click to view products by [Bencent](#) manufacturer:

Other Similar products are found below :

[PMT1023004](#) [PMT1025001](#) [RF3161-000](#) [PMT1035004](#) [PMT1040004](#) [PMT809006](#) [CG2250](#) [CG2800](#) [CG31.5L](#) [GT-SMD181240012-TR](#)
[WPGT-2N145B6L](#) [WPGT-2N230B6L](#) [WPGT-2N470B6L](#) [WPGT-2R470B6L](#) [WPGT-2RM230A6L](#) [WPGT-2RM350A6L](#) [WPGT-](#)
[2RM70A6L](#) [WPGT-2RM90A6L](#) [WPGT-2S145](#) [WPGT-2S350](#) [WPGT-2S470](#) [WPGT-3R350CF](#) [WPGT-3R350G1](#) [WPGT-3R90G1](#) [WPGT-](#)
[3R75G1](#) [WPGT-3R470G1](#) [WPGT-3R250C](#) [WPGT-3R230G1](#) [WPGT-2S230](#) [WPGT-2RM470A6L](#) [WPGT-2RM145A6L](#) [WPGT-2R3000B8L](#)
[WPGT-2R2700B8L](#) [WPGT-2R1000B8L](#) [WPGT-2N90B6L](#) [WPGT-2N70B6L](#) [WPGT-2N350B6L](#) [WPGT-2N230B6L1](#) [CG90](#) [CG2230](#)
[CG2145](#) [CG21000](#) [GT-SMD181215012-TR](#) [B88069X6940B152](#) [V20-1+NPE-280](#) [V20-3+NPE+FS-280](#) [SD09-V24 9](#) [C50-0-255](#)
[SG24PA300](#) [A9L40500](#)