

Features

- Size Design  $\Phi 8 \times 6 \text{mm}$
- High Current Handling Capability 5,000A @ 8/20  $\mu\text{s}$
- Low Capacitance and Insertion Loss
- Fast Response and Long Service Life
- Reliable to Protect Electrostatic Surge
- Moisture sensitivity level: Level 1

Exterior

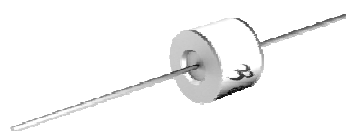

Application information

- AC Power

Package (Top View)



Agency Approvals

Icon	Description
<b>RoHS</b>	Compliance with 2011/65/EU
<b>HF</b>	Compliance with IEC61249-2-21:2003
	Mean lead free
<b>UL</b>	Compliance with UL1449, Certificated E337906

Schematic Symbol

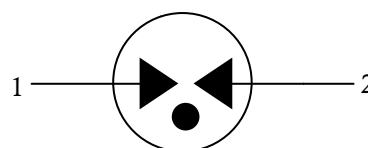

Electrical Parameter

DC Breakdown Voltage <sup>1) 2)</sup>	100V/s	2880-4320	V
Surge Test	1.2/50 $\mu\text{s}$ @6KV	$\leq 6000$	V
Impulse Discharge Current <sup>3)</sup>	8/20 $\mu\text{s}$ $\pm 5$ times	5	KA
Arc Voltage	At 1A	$\sim 15$	V
Insulation Resistance	DC=100V	$\geq 1$	G $\Omega$
Capacitance at 1 MHz	V <sub>DC</sub> =0.5V	$\leq 1.5$	pF
Weight		$\sim 1.62$	g
Operating and storage Temperature		-40-90	$^{\circ}\text{C}$
Marking		 -Bencent logo/ 3600 -Electrical specifications/ 1401-Production Date,14:Year 2014,01:January	

1) At delivery AQL 0.65 level II GB/T 2828.1-2003

2) In ionized mode

3) Terms and current waveforms in accordance with ITU-T Rec. K. 12; IEC 61643-21

**Part Numbering System**

B8G      3600      L  
(1)      (2)      (3)

- (1) Bencent 2-Electrode DIP Gas Discharge Tube with dimension:  $\Phi 8.0 \times 6$  (D×L) (mm)  
 (2) DC Breakdown Voltage, e.g., 3600=3600V  
 (3) Surge Rating @8/20  $\mu$  s, L=5KA

**Product Characteristics**

Lead Material	Copper
Body Material	Ceramics Iron-nickel electrode
Terminal Finish	100% Matte-Tin Plated

**Environmental Reliability Characteristics**

Testing items	Technical standards
High Temperature Storage Test	Temperature: 90°C Time: 2H
Low Temperature Storage Test	Temperature: -40°C Time: 2H
Vibration	Frequency: 10-500Hz Amplitude: 0.15mm Time: 45mins
Resistance of soldering heat	Temperature: 260±5°C Time of dip soldering: 10s, 1time

Note: Up-screen program can be specified by customer's request via contacting Bencent service

**Solderability test**

Solderability	Solder Pot Temperature:	245°C ± 5°C
	Solder Dwell Time:	4-6 seconds

**Product Dimensions**

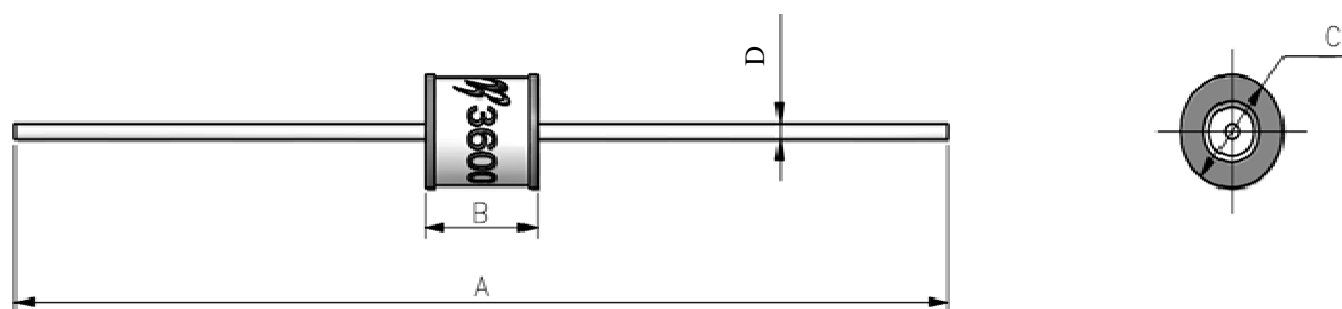

REF	mm	inch
A	62±2	2.441 ± 0.079
B	6±0.2	0.236 ± 0.008
C	$\Phi 8 \pm 0.2$	$\Phi 0.315 \pm 0.008$
D	$\Phi 0.8 \pm 0.06$	$\Phi 0.0315 \pm 0.0024$

Wave Soldering profile

Wave Soldering Condition		Pb-Free assembly
Pre Heat	Temperature Min	100°C
	Temperature Max	150°C
	Time (min to max)	60 – 180 secs
Solder Pot Temperature		280°C Max
Solder Dwell Time		2-5 seconds

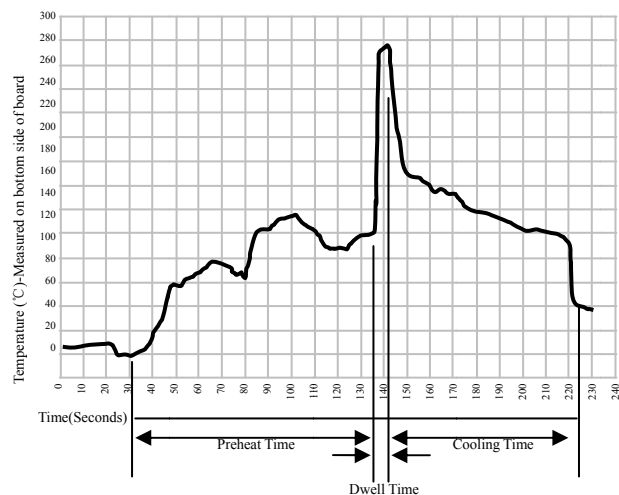

Package Reel Information

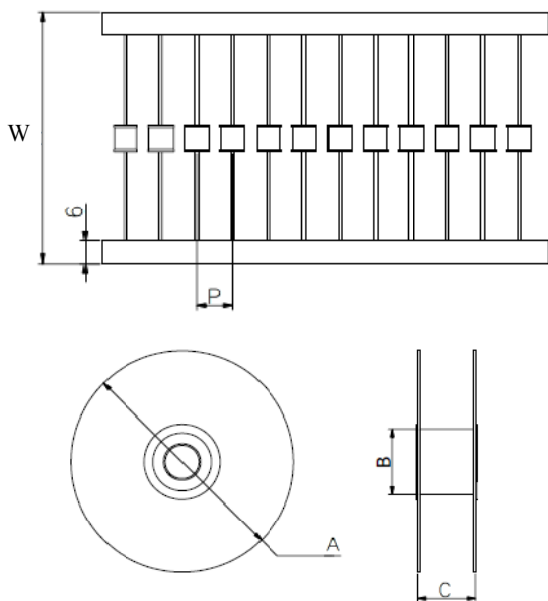

REF	mm	inch
W	65±3	2.559±0.118
P	10±1	0.394±0.039
A	Φ340±2	Φ13.386±0.079
B	Φ83±2	Φ3.268±0.079
C	73±3	2.874±0.118

OUTLINE	REEL (PCS)	PER CARTON (PCS)	CARTON SIZE(mm)		
			L	W	H
TAPING	700	4200	480	350	360

## X-ON Electronics

Largest Supplier of Electrical and Electronic Components

*Click to view similar products for [Gas Discharge Tubes - GDTs / Gas Plasma Arrestors](#) category:*

*Click to view products by [Bencent](#) manufacturer:*

Other Similar products are found below :

[PMT1023004](#) [PMT1025001](#) [RF3161-000](#) [PMT1035004](#) [PMT1040004](#) [PMT809006](#) [CG2250](#) [CG2800](#) [CG31.5L](#) [GT-SMD181240012-TR](#)  
[WPGT-2N145B6L](#) [WPGT-2N230B6L](#) [WPGT-2N470B6L](#) [WPGT-2R470B6L](#) [WPGT-2RM230A6L](#) [WPGT-2RM350A6L](#) [WPGT-](#)  
[2RM70A6L](#) [WPGT-2RM90A6L](#) [WPGT-2S145](#) [WPGT-2S350](#) [WPGT-2S470](#) [WPGT-3R350CF](#) [WPGT-3R350G1](#) [WPGT-3R90G1](#) [WPGT-](#)  
[3R75G1](#) [WPGT-3R470G1](#) [WPGT-3R250C](#) [WPGT-3R230G1](#) [WPGT-2S230](#) [WPGT-2RM470A6L](#) [WPGT-2RM145A6L](#) [WPGT-2R3000B8L](#)  
[WPGT-2R2700B8L](#) [WPGT-2R1000B8L](#) [WPGT-2N90B6L](#) [WPGT-2N70B6L](#) [WPGT-2N350B6L](#) [WPGT-2N230B6L1](#) [CG90](#) [CG2230](#)  
[CG2145](#) [CG21000](#) [GT-SMD181215012-TR](#) [9071.99.0547 \(73\\_Z-0-0-547\)](#) [B88069X6940B152](#) [V20-1+NPE-280](#) [V20-3+NPE+FS-280](#)  
[SD09-V24 9](#) [C50-0-255](#) [SG24PA300](#)