

Features

- Size Design 8.3×8.3×6mm
- High Current Handling Capability 20,000A @ 8/20μs
- Low Capacitance and Insertion Loss
- Fast Response and Long Service Life
- Reliable to Protect Electrostatic Surge
- Moisture sensitivity level: Level 1

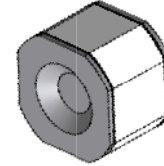

Exterior

SMD

Application information

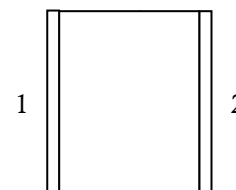
- AC Power

Package (Top View)

Agency Approvals

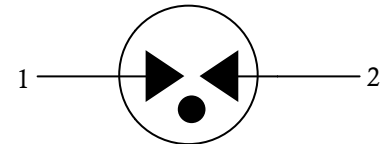
Icon	Description
RoHS	Compliance with 2011/65/EU
HF	Compliance with IEC61249-2-21:2003
	Mean lead free
	Compliance with UL1449, Certificated E337906

Schematic Symbol

Electrical Parameter

DC Breakdown Voltage ^{1) 2)}	100V/s	376-564	V
Impulse Spark-over Voltage	At 1kV/μs	for 99 % of measured values ≤850	V
	At 1kV/μs	Typical values of distribution ≤800	V
Impulse Discharge Current ³⁾	8/20μs ±5times	20,000	A
Arc Voltage	At 1A	~15	V
Insulation Resistance	DC=50V	≥1	GΩ
Co (1MHz)	V _{DC} =0.5V	≤1.5	pF
Weight		~1.75	g
Operating and storage Temperature		-40-90	°C
Marking		Without	

1) At delivery AQL 0.65 level II GB/T 2828.1-2003

2) In ionized mode

3) Terms and current waveforms in accordance with ITU-T Rec. K. 12; IEC 61643-21

Part Numbering System

BM XXX M
 (1) (2) (3)

(1) Bencent SMD Gas Discharge Tube in 8.3×8.3×6 (L×W×H) (mm)

(2) DC Breakdown Voltage, e.g., 471=47×10¹=470V

(3) Tolerance is DC Breakdown Voltage, M=±20%, N=±30%

Product Characteristics

Lead Material	Copper
Body Material	Ceramics
Terminal Finish	100% Matte-Tin Plated

Environmental Reliability Characteristics

Testing items	Technical standards
High Temperature Storage Test	Temperature: 85°C Time: 2H
Low Temperature Storage Test	Temperature: -40°C Time: 2H
Vibration	Frequency: 10-500Hz Amplitude: 0.15mm Time: 45min
Resistance of soldering heat	Temperature: 260±5°C Time of dip soldering: 10s, 1times

Note: Up-screen program can be specified by customer's request via contacting Bencent service

Solderability Test

Solderability	Solder Pot Temperature:	245°C±5°C	Lead-Free Recommendation
	Solder Dwell Time:	4-6 seconds	

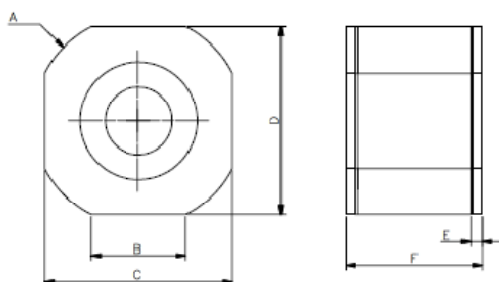
Product Dimensions

REF	mm	inch
A	Φ9.3±0.1	Φ0.366±0.004
B	4.2±0.1	0.165±0.004
C	8.3±0.2	0.327±0.008
D	8.3±0.2	0.327±0.008
E	0.5±0.05	0.02±0.002
F	6±0.2	0.236±0.008

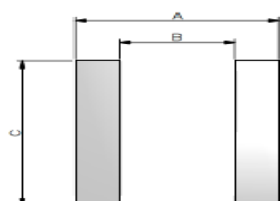
Recommended Soldering Pad

REF	mm	inch
A	7.95	0.313
B	4.5	0.177
C	8	0.315

Reflow Profile

Reflow Condition		Pb-Free assembly
Pre Heat	Temperature Min	150°C
	Temperature Max	200°C
	Time (min to max)	60 – 180 secs.
Average ramp up rate (Liquidus) T _{amp} (T _L) to peak		3°C/sec. max
T _S (max) to T _L - Ramp-up Rate		3°C/sec. max
Reflow	- Temperature (T _L) (Liquidus)	217°C
	- Temperature (T _L)	60 – 150 secds.
Peak Temperature (T _p)		260+0/-5 °C
Time within 5°C of actual peak Temperature (t _p)		20 – 40 secds.
Ramp-down Rate		6°C/sec. max
Time 25°C to peak Temperature (T _p)		8 mins. Max.
Do not exceed		260°C

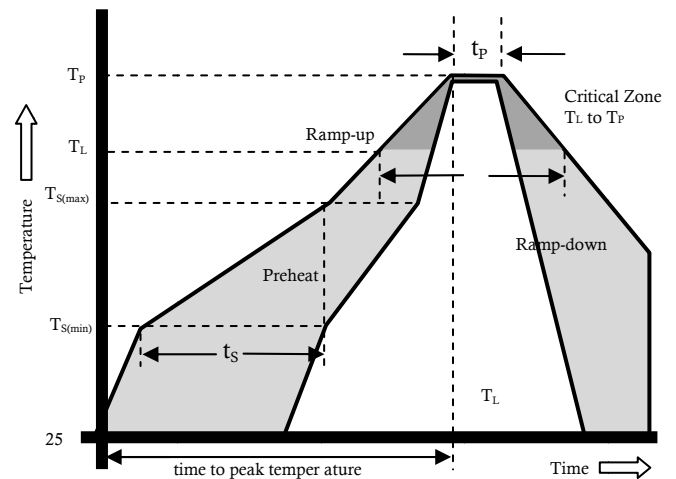
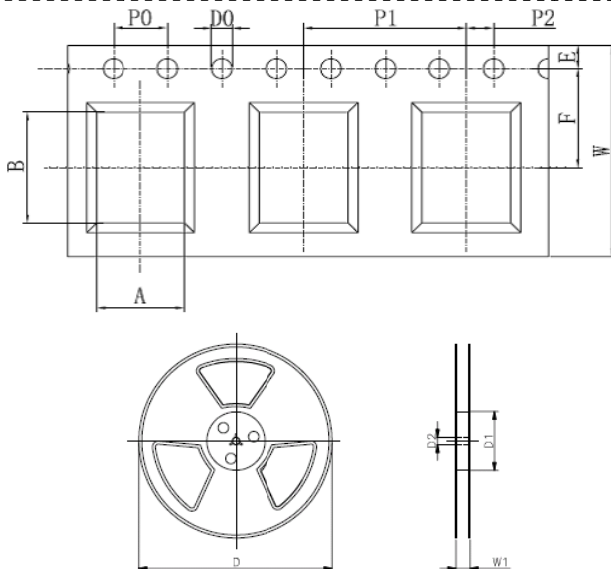
Package Reel Information

REF	mm	inch
P0	4.0±0.1	0.157±0.004
D0	Φ1.5 ^{+0.1} ₋₀	Φ0.059 ^{+0.004} ₋₀
P1	12±0.1	0.472±0.004
P2	2.0±0.1	0.079±0.004
A	6.5±0.2	0.256±0.008
B	8.4±0.2	0.331±0.008
F	7.5±0.1	0.295±0.004
E	1.75±0.1	0.069±0.004
W	16±0.3	0.63±0.012
D	Φ330±2	Φ12.99±0.079
D1	Φ100±2	Φ3.94±0.079
D2	Φ13±0.15	0.512±0.006
W1	21±2	0.827±0.079

OUTLINE	REEL (PCS)	INSIDE CARTON (PCS)	PER CARTON (PCS)	CARTON SIZE(mm)		
				L	W	H
TAPING	500	1000	8000	360	360	380

X-ON Electronics

Largest Supplier of Electrical and Electronic Components

Click to view similar products for [Gas Discharge Tubes - GDTs / Gas Plasma Arrestors](#) *category:*

Click to view products by [Bencent](#) *manufacturer:*

Other Similar products are found below :

[PMT1023004](#) [PMT1025001](#) [PMT1035004](#) [PMT1040004](#) [PMT809006](#) [CG2250](#) [CG2800](#) [CG31.5L](#) [GT-SMD181240012-TR](#) [WPGT-2N145B6L](#) [WPGT-2N230B6L](#) [WPGT-2N470B6L](#) [WPGT-2R470B6L](#) [WPGT-2RM230A6L](#) [WPGT-2RM350A6L](#) [WPGT-2RM70A6L](#) [WPGT-2RM90A6L](#) [WPGT-2S145](#) [WPGT-2S350](#) [WPGT-2S470](#) [WPGT-3R350CF](#) [WPGT-3R350G1](#) [WPGT-3R90G1](#) [WPGT-3R75G1](#) [WPGT-3R470G1](#) [WPGT-3R250C](#) [WPGT-3R230G1](#) [WPGT-2S230](#) [WPGT-2RM470A6L](#) [WPGT-2RM145A6L](#) [WPGT-2R3000B8L](#) [WPGT-2R2700B8L](#) [WPGT-2R1000B8L](#) [WPGT-2N90B6L](#) [WPGT-2N70B6L](#) [WPGT-2N350B6L](#) [WPGT-2N230B6L1](#) [CG90](#) [CG2230](#) [CG2145](#) [CG21000](#) [GT-SMD181215012-TR](#) [T61-C350X](#) [9071.99.0547 \(73_Z-0-0-547\)](#) [9071.99.0548 \(73_Z-0-0-548\)](#) [B88069X6940B152](#) [9071.99.0052\(73_Z-0-0-52\)](#) [B88069X1973T902](#) [V20-1+NPE-280](#) [A9L15692](#)