

Features

- IEC 61000-4-2(ESD) $\pm 15\text{KV}$ (air), $\pm 8\text{KV}$ (contact)
- 1500Watts peak pulse power ($t_p=10/1000\mu\text{S}$)
- Quick response to surge voltage
- Low clamping voltage
- Moisture sensitivity level: Level 1
- Molding compound meets UL 94 V-0 flammability rating
- EFT protection of data lines in accordance with IEC 61000-4-4 (IEC801-4)

Exterior



DO-214AB (SMC)

Application Information

- DC Port
- RS485/232/422
- I/O Port

Agency Approvals

Icon	Description
RoHS	Compliance with 2011/65/EU
HF	Compliance with IEC61249-2-21:2003
UL	UL Certificated E232249

Schematic Symbol



BI-directional



UNI-directional

Part Number and Electrical Parameter

Part Number		Marking		V_R (V)	V_{BR} min.(V)	V_{BR} max.(V)	I_t (mA)	Max $V_C@I_{PP}^{\text{D}}$ (V)	I_{PP}^{D} (A)	$I_R@V_R$ (uA)
BI	UNI	BI	UNI							
BV-SMCJ5CA	BV-SMCJ5A	C5C	C5	5	6.4	7	10	9.2	163.0	800
BV-SMCJ6CA	BV-SMCJ6A	C6C	C6	6	6.67	7.37	10	10.3	145.7	800
BV-SMCJ6.5CA	BV-SMCJ6.5A	C6.5C	C6.5	6.5	7.22	7.98	10	11.2	134.0	500
BV-SMCJ7CA	BV-SMCJ7A	C7C	C7	7	7.78	8.6	10	12	125.0	200
BV-SMCJ7.5CA	BV-SMCJ7.5A	C7.5C	C7.5	7.5	8.33	9.21	1	12.9	116.3	100
BV-SMCJ8CA	BV-SMCJ8A	C8C	C8	8	8.89	9.83	1	13.6	110.3	50
BV-SMCJ8.5CA	BV-SMCJ8.5A	C8.5C	C8.5	8.5	9.44	10.4	1	14.4	104.2	20
BV-SMCJ9CA	BV-SMCJ9A	C9C	C9	9	10	11.1	1	15.4	97.4	10
BV-SMCJ10CA	BV-SMCJ10A	C10C	C10	10	11.1	12.3	1	17	88.3	5
BV-SMCJ11CA	BV-SMCJ11A	C11C	C11	11	12.2	13.5	1	18.2	82.5	1
BV-SMCJ12CA	BV-SMCJ12A	C12C	C12	12	13.3	14.7	1	19.9	75.4	1
BV-SMCJ13CA	BV-SMCJ13A	C13C	C13	13	14.4	15.9	1	21.5	69.8	1
BV-SMCJ14CA	BV-SMCJ14A	C14C	C14	14	15.6	17.2	1	23.2	64.7	1
BV-SMCJ15CA	BV-SMCJ15A	C15C	C15	15	16.7	18.5	1	24.4	61.5	1
BV-SMCJ16CA	BV-SMCJ16A	C16C	C16	16	17.8	19.7	1	26	57.7	1
BV-SMCJ17CA	BV-SMCJ17A	C17C	C17	17	18.9	20.9	1	27.6	54.4	1
BV-SMCJ18CA	BV-SMCJ18A	C18C	C18	18	20	22.1	1	29.2	51.4	1

Part Number		Marking		V _R (V)	V _{BR} min.(V)	V _{BR} max.(V)	I _t (mA)	Max V _{C@I_{PP}} (V)	I _{PP} ^① (A)	I _{R@V_R} (uA)
BI	UNI	BI	UNI							
BV-SMCJ20CA	BV-SMCJ20A	C20C	C20	20	22.2	24.5	1	32.4	46.3	1
BV-SMCJ22CA	BV-SMCJ22A	C22C	C22	22	24.4	26.9	1	35.5	42.3	1
BV-SMCJ24CA	BV-SMCJ24A	C24C	C24	24	26.7	29.5	1	38.9	38.6	1
BV-SMCJ26CA	BV-SMCJ26A	C26C	C26	26	28.9	31.9	1	42.1	35.7	1
BV-SMCJ28CA	BV-SMCJ28A	C28C	C28	28	31.1	34.4	1	45.4	33.1	1
BV-SMCJ30CA	BV-SMCJ30A	C30C	C30	30	33.3	36.8	1	48.4	31.0	1
BV-SMCJ33CA	BV-SMCJ33A	C33C	C33	33	36.7	40.6	1	53.3	28.2	1
BV-SMCJ36CA	BV-SMCJ36A	C36C	C36	36	40	44.2	1	58.1	25.9	1
BV-SMCJ40CA	BV-SMCJ40A	C40C	C40	40	44.4	49.1	1	64.5	23.3	1
BV-SMCJ43CA	BV-SMCJ43A	C43C	C43	43	47.8	52.8	1	69.4	21.7	1
BV-SMCJ45CA	BV-SMCJ45A	C45C	C45	45	50	55.3	1	72.7	20.6	1
BV-SMCJ48CA	BV-SMCJ48A	C48C	C48	48	53.3	58.9	1	77.4	19.4	1
BV-SMCJ51CA	BV-SMCJ51A	C51C	C51	51	56.7	62.7	1	82.4	18.2	1
BV-SMCJ54CA	BV-SMCJ54A	C54C	C54	54	60	66.3	1	87.1	17.3	1
BV-SMCJ58CA	BV-SMCJ58A	C58C	C58	58	64.4	71.2	1	93.6	16.1	1
BV-SMCJ60CA	BV-SMCJ60A	C60C	C60	60	66.7	73.7	1	96.8	15.5	1
BV-SMCJ64CA	BV-SMCJ64A	C64C	C64	64	71.1	78.6	1	103	14.6	1
BV-SMCJ70CA	BV-SMCJ70A	C70C	C70	70	77.8	86	1	113	13.3	1
BV-SMCJ75CA	BV-SMCJ75A	C75C	C75	75	83.3	92.1	1	121	12.4	1
BV-SMCJ78CA	BV-SMCJ78A	C78C	C78	78	86.7	95.8	1	126	11.9	1
BV-SMCJ85CA	BV-SMCJ85A	C85C	C85	85	94.4	104	1	137	11.0	1
BV-SMCJ90CA	BV-SMCJ90A	C90C	C90	90	100	111	1	146	10.3	1
BV-SMCJ100CA	BV-SMCJ100A	C100C	C100	100	111	123	1	162	9.3	1
BV-SMCJ110CA	BV-SMCJ110A	C110C	C110	110	122	135	1	177	8.5	1
BV-SMCJ120CA	BV-SMCJ120A	C120C	C120	120	133	147	1	193	7.8	1
BV-SMCJ130CA	BV-SMCJ130A	C130C	C130	130	144	159	1	209	7.2	1
BV-SMCJ150CA	BV-SMCJ150A	C150C	C150	150	167	185	1	243	6.2	1
BV-SMCJ160CA	BV-SMCJ160A	C160C	C160	160	178	197	1	259	5.8	1
BV-SMCJ170CA	BV-SMCJ170A	C170C	C170	170	189	209	1	275	5.5	1
BV-SMCJ180CA ^②	BV-SMCJ180A ^②	C180C	C180	180	201	222	1	292	5.1	1
BV-SMCJ200CA ^②	BV-SMCJ200A ^②	C200C	C200	200	224	247	1	324	4.6	1
BV-SMCJ220CA ^②	BV-SMCJ220A ^②	C220C	C220	220	246	272	1	356	4.2	1
BV-SMCJ250CA ^②	BV-SMCJ250A ^②	C250C	C250	250	279	309	1	405	3.7	1
BV-SMCJ300CA ^②	BV-SMCJ300A ^②	C300C	C300	300	335	371	1	486	3.1	1
BV-SMCJ350CA ^②	BV-SMCJ350A ^②	C350C	C350	350	391	432	1	567	2.6	1
BV-SMCJ400CA ^②	BV-SMCJ400A ^②	C400C	C400	400	447	494	1	648	2.3	1
BV-SMCJ440CA ^②	BV-SMCJ440A ^②	C440C	C440	440	492	543	1	713	2.1	1

Note: absolute maximum ratings measured at T= 25°C RH = 45%-75% (unless otherwise noted).

① Surge Waveform: 10/1000μS

② These models do not have UL497B safety certification

Mark



BI:CXXC

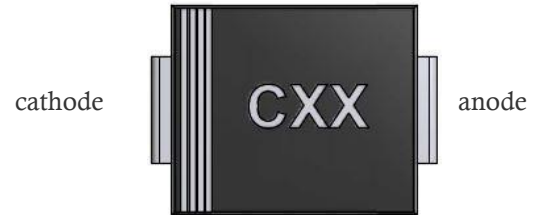

UNI:CXX

Part Number System

BV SMCJ XX C A
 (1) (2) (3) (4) (5)

- (1) Bencent Transient Voltage Suppressor
- (2) Series Code
- (3) $V_R=XXV$
- (4) BI-directional
- (5) Suffix 'A' denotes 5% tolerance devices

V-I Curve

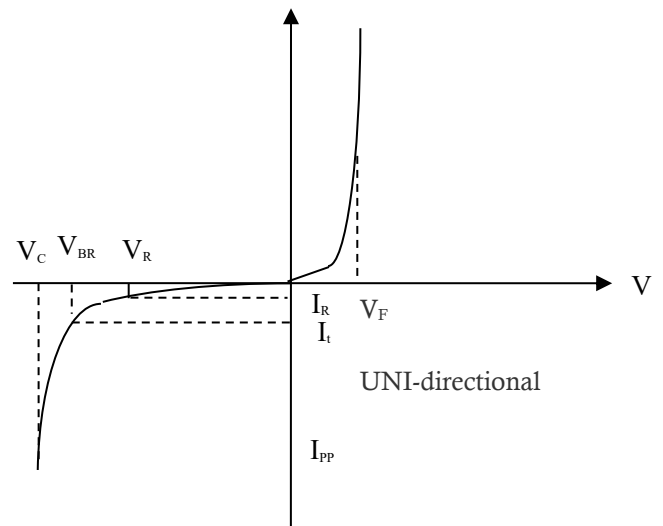
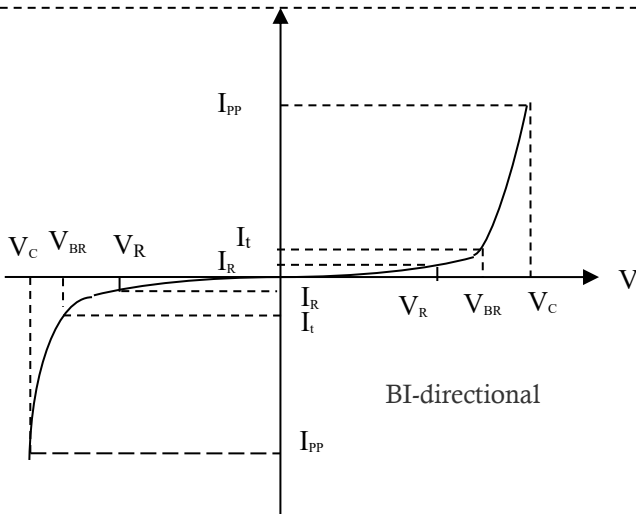

Parameters	Definition
V_F	Forward Voltage drop for UNI-directional
V_C	Clamping Voltage
I_{pp}	Surge Waveform 10/1000 μ s
V_R	Stand-off Voltage
V_{BR}	Breakdown Voltage
I_R	Reverse Leakage Current
I_t	Test Current
P_{pp}	Peak Pulse Power Dissipation

Transient Voltage Suppressor

Version: B1 2020/08/12

Thermal Considerations

symbol	Parameter	Value	Unit
T_J	Operating Junction Temperature Range	-55 to +150	°C
T_S	Storage Temperature Range	-55 to +150	°C
VF	Maximum Instantaneous Forward; Voltage at 100A for Unidirectional Only (Note 1)	3.5/5	V
I_{FSM}	Peak Forward Surge Current, 8.3ms;Single Half Sine Wave (Note 2)	200	A

Notes:

1. VF < 3.5V for single die parts and VF < 5.0V for stacked-die parts.
2. Measured on 8.3ms single half sine wave or equivalent square wave for unidirectional device only.

Typical Characteristics

Peak Pulse Power Rating Curve

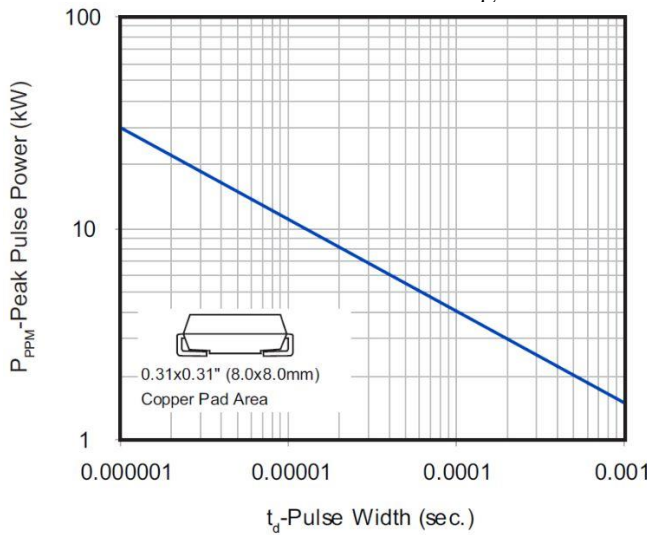

Pulse Derating Curve

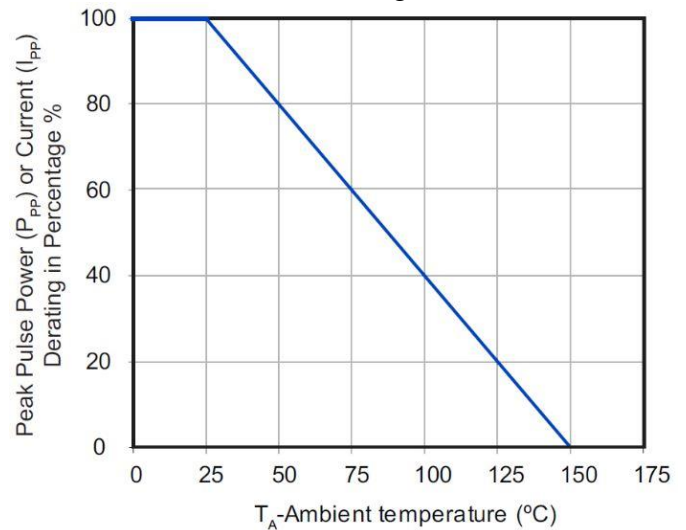

Pulse Waveform

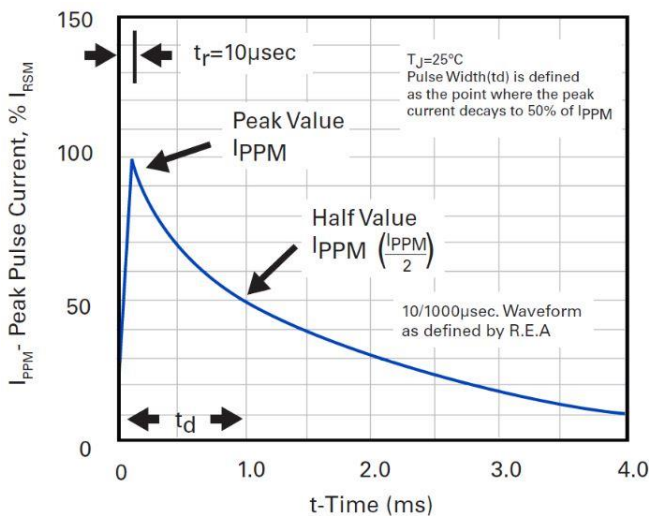

Typical Junction Capacitance

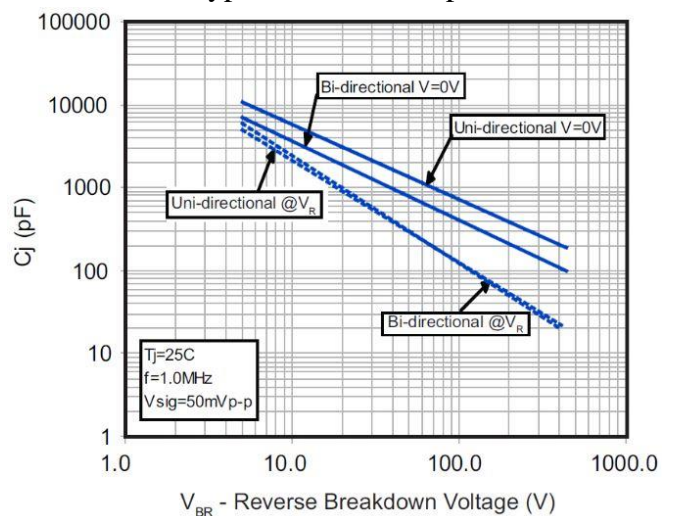

Steady State Power Dissipation Derating Curve

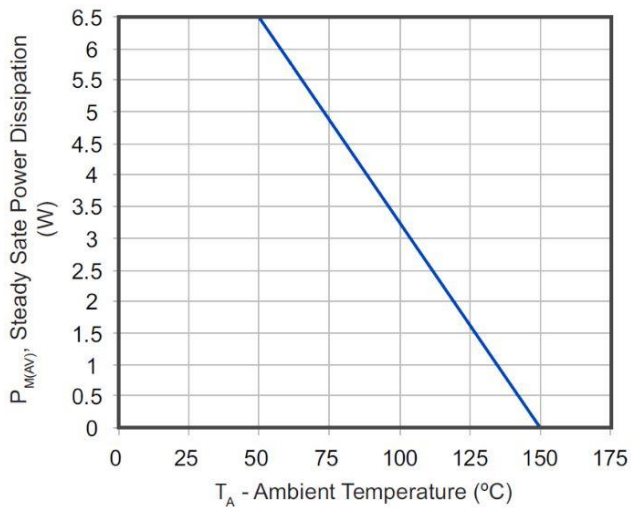

Maximum Non-Repetitive Forward Surge Current Uni-Directional Only

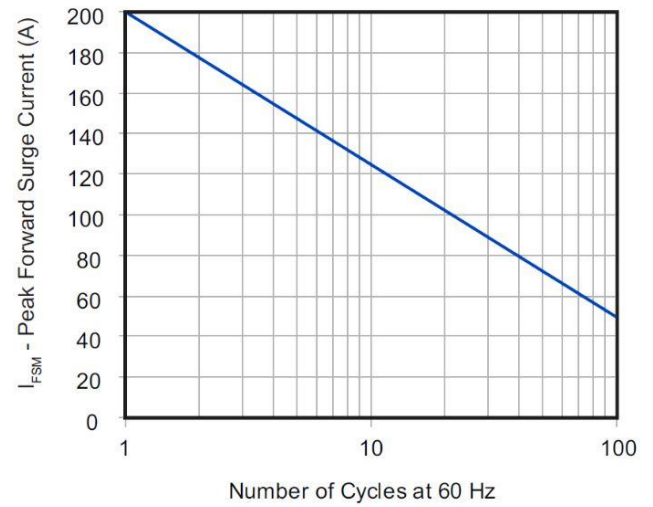

Product Dimensions

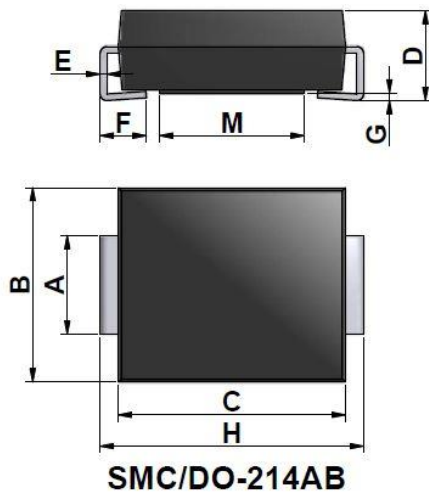

REF	mm	inch
A	3 ± 0.1	0.118 ± 0.004
B	5.9 ± 0.3	0.232 ± 0.012
C	7 ± 0.2	0.276 ± 0.008
D	2.6 ± 0.35	0.102 ± 0.014
E	0.2 ± 0.1	0.008 ± 0.004
F	1.3 ± 0.4	0.051 ± 0.016
G	0 ~ 0.4	0.000 ~ 0.016
H	8 ± 0.3	0.315 ± 0.012
M	4.4 ± 0.2	0.173 ± 0.008

Recommended Soldering Pad

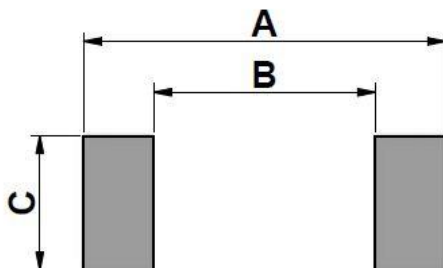

REF	mm	inch
A	8.25	0.325
B	5.05	0.199
C	3.05	0.120

Transient Voltage Suppressor

Version: B1 2020/08/12

Reflow Profile

Reflow Condition		Pb-Free Assembly
Pre Heat	Temperature Min.	+150°C
	Temperature Max.	+200°C
	Time(Min to Max)	60 – 180 seconds
Average ramp up rate (Liquidus Temp (T _L) to peak)		3°C/second max
Ts(max) to T _L - Ramp-up Rate		3°C/second max
Reflow	- Temperature (T _L) (Liquidus)	217°C
	- Temperature (T _i)	60 – 150 seconds
Peak Temp (T _P)		260+0/-5 °C
Time within 5°C of actual Peak Temp (T _P)		8-15 seconds
Ramp-down Rate		6°C/s max
Time 25°C to peak Temp (T _P)		8 min max.
Do not exceed		260°C

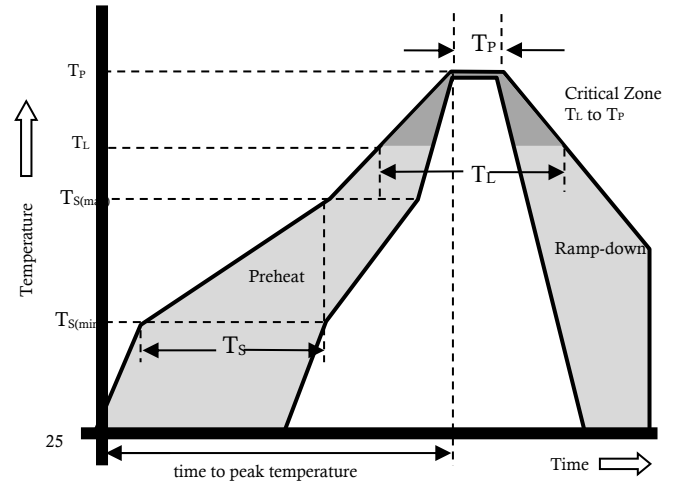
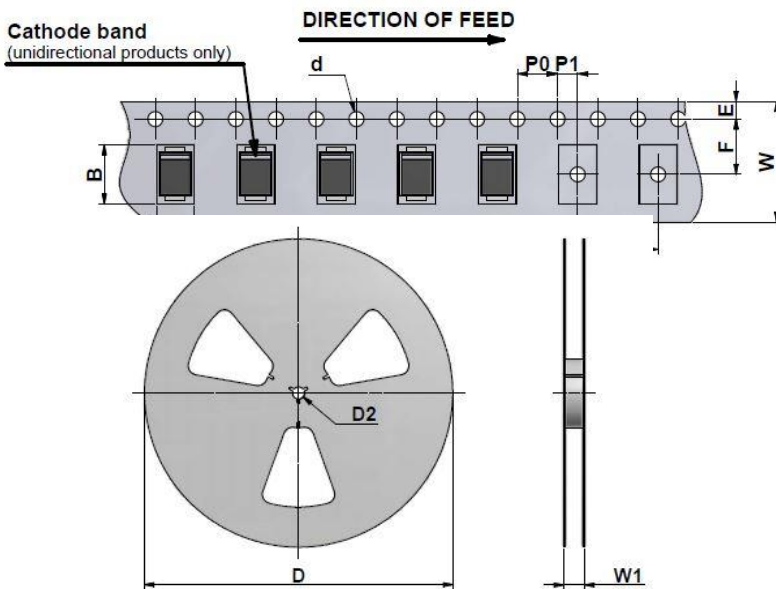
Package Reel Information

REF.	mm	inch
A	6.1±0.3	0.240±0.012
B	8.3±0.3	0.327±0.012
d	1.5±0.1	0.059±0.004
D	330.0	13.0
D2	13±1.5	0.512±0.059
E	1.7±0.3	0.067±0.012
F	7.5±0.3	0.295±0.012
P	8±0.3	0.315±0.012
P0	4±0.3	0.157±0.012
P1	2±0.3	0.079±0.012
W	16±0.5	0.630±0.020
W1	23±3	0.906±0.118

Outline	Reel (pcs)	Per Carton (pcs)	Reel Diameters (mm)	Carton Size(mm)		
				L	W	H
Taping	3,000	48,000	330	360	360	385

X-ON Electronics

Largest Supplier of Electrical and Electronic Components

Click to view similar products for [ESD Suppressors / TVS Diodes](#) category:

Click to view products by [Bencent](#) manufacturer:

Other Similar products are found below :

[60KS200C](#) [D18V0L1B2LP-7B](#) [D5V0F4U5P5-7](#) [DESD5V0U1BB-7](#) [NTE4902](#) [P4KE27CA](#) [P6KE11CA](#) [P6KE39CA-TP](#) [P6KE8.2A](#)
[SA110CA](#) [SA60CA](#) [SA64CA](#) [SMBJ12CATR](#) [SMBJ33CATR](#) [SMBJ8.0A](#) [ESD101-B1-02ELS E6327](#) [ESD105-B1-02EL E6327](#) [ESD112-B1-02EL E6327](#) [ESD119B1W01005E6327XTSA1](#) [ESD5V0L1B02VH6327XTSA1](#) [ESD7451N2T5G](#) [19180-510](#) [CPDT-5V0USP-HF](#)
[3.0SMCJ33CA-F](#) [3.0SMCJ36A-F](#) [HSPC16701B02TP](#) [D3V3Q1B2DLP3-7](#) [D55V0M1B2WS-7](#) [DESD5V0U1BL-7B](#) [DRTR5V0U4SL-7](#)
[SCM1293A-04SO](#) [ESD200-B1-CSP0201 E6327](#) [SM12-7](#) [SMF8.0A-TP](#) [SMLJ45CA-TP](#) [SMQA1000T1G](#) [CEN955 W/DATA](#) [82350120560](#)
[VESD12A1A-HD1-GS08](#) [CPDUR5V0R-HF](#) [CPDQC5V0U-HF](#) [CPDQC5V0USP-HF](#) [CPDQC5V0-HF](#) [IP4042CX5/LF,135](#) [D1213A-01LP4-7B](#) [D1213A-02WL-7](#) [1SMB33CAT3G-XYZ](#) [MMAD1108/TR13](#) [5KP100A](#) [5KP15A](#)