

Sil-Pad® Design Guide

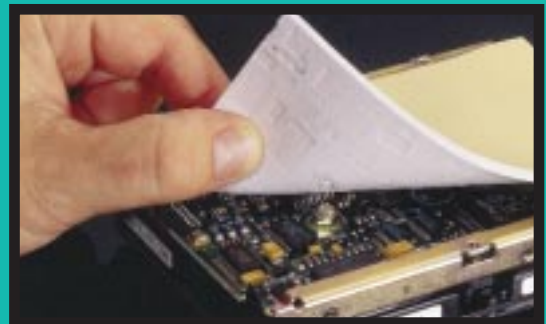

All statements, technical information and recommendations herein are based on tests we believe to be reliable, and THE FOLLOWING IS MADE IN LIEU OF ALL WARRANTIES, EXPRESSED OR IMPLIED, INCLUDING THE IMPLIED WARRANTIES OF MARKETABILITY AND FITNESS FOR PURPOSE. Sellers' and manufacturers' only obligation shall be to replace such quantity of the product proved to be defective. Before using, user shall determine the suitability of the product for its intended use, and the user assumes all risks and liability whatsoever in connection therewith. NEITHER SELLER NOR MANUFACTURER SHALL BE LIABLE EITHER IN TORT OF IN CONTRACT FOR ANY LOSS OR DAMAGE, DIRECT, INCIDENTAL, OR CONSEQUENTIAL, INCLUDING LOSS OF PROFITS OR REVENUE ARISING OUT OF THE USE OR THE INABILITY TO USE A PRODUCT. No statement, purchase order or recommendations by seller or purchaser not contained herein shall have any force or effect unless in an agreement signed by the officers of the seller and manufacturer.

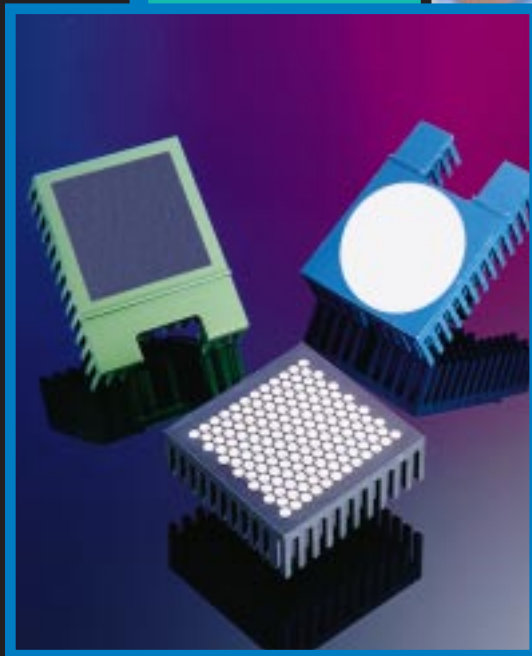

The Bergquist Company established the standard for elastomeric thermally conductive insulation material with the development of Sil-Pads[®] over 20 years ago. Sil-Pads were developed as a clean, grease-free alternative to mica and grease. Now, a complete family of materials is available to meet the diverse and changing requirements of today's design engineer.

MICA AND GREASE

Mica insulators have been in use for over 30 years and are still commonly used as an insulator. Mica is inexpensive and has excellent dielectric strength, but it is brittle and is easily cracked or broken. Because mica used by itself has high thermal impedance, thermal grease is commonly applied to it. The grease flows easily and excludes air from the interface to reduce the interfacial thermal resistance. If the mica is also thin (2-3 mils), (50-80 μm), a low thermal impedance can be achieved.

However, thermal grease introduces a number of problems to the assembly process. It is time-consuming to apply, messy, and difficult to clean. Once thermal grease has been applied to an electronic assembly, solder processes must be avoided to prevent

contamination of the solder. Cleaning baths must also be avoided to prevent wash-out of the interface grease, causing a dry joint and contamination of the bath.

Assembly, soldering and cleaning

processes must be performed in one process while the greased insulators are installed off-line in a secondary process. If the grease is silicone based, migration of silicone molecules occurs over time, drying out the grease and contaminating the assembly. Silicone migration onto electrical contacts can result in pitting of the contacts and loss of electrical conductance. For this reason, silicone based, thermal grease has not been used in telecommunications systems.



Why Choose Sil-Pad Thermally Conductive



At Bergquist's Cannon Falls, MN manufacturing facility, a Sil-Pad material runs through a 3-story coating press.

POLYIMIDE FILMS

Polyimide films can also be used as insulators and are often combined with wax or grease to achieve a low thermal impedance. These polyimide films are especially tough and have high dielectric strength. Sil-Pad K-4[®], K-6[®] and K-10[®] incorporate polyimide film as the carrier material.

CERAMIC INSULATORS

Other insulation materials include ceramic wafer insulators which have higher thermal conductivity than mica. They are often used thicker (20-60 mils), (.5 to 1.5 mm) to reduce capacitive coupling while maintaining a low thermal impedance.

Drawbacks to ceramic insulators are high cost and they are rigid like mica and crack easily. Also, ceramic beryllia use requires careful handling since inhalation of beryllia dust can cause lung inflammation (berylliosis).

SIL-PAD® MATERIALS

Sil-Pad Thermally Conductive Insulators are designed to be clean, grease-free and flexible. The combination of a tough carrier material such as fiberglass and silicone rubber which is conformable, provides the engineer with a more versatile material than mica or ceramics and grease. Sil-Pads minimize the thermal resistance from the case of a power semiconductor to the heat sink. Sil-Pads electrically isolate the semiconductor from the heat sink and have sufficient dielectric strength to withstand high voltage. They are also tough enough to resist puncture by the facing metal surface. With more than 30 different Sil-Pad materials available there is a Sil-Pad matched to almost any application.

SIL-PAD® CONSTRUCTION

Sil-Pads are constructed with a variety of different materials including fiberglass, silicone rubber, polyimide film, polyester film and fillers used to enhance performance. Sil-Pads are typically constructed with an elastomeric binder compounded with a thermally conductive filler coated on a carrier.

The characteristics of your application often determine which Sil-Pad construction will produce the best performance. Sil-Pads are typically constructed with an elastomeric binder compounded with a thermally conductive filler coated on a carrier.

Insulators?

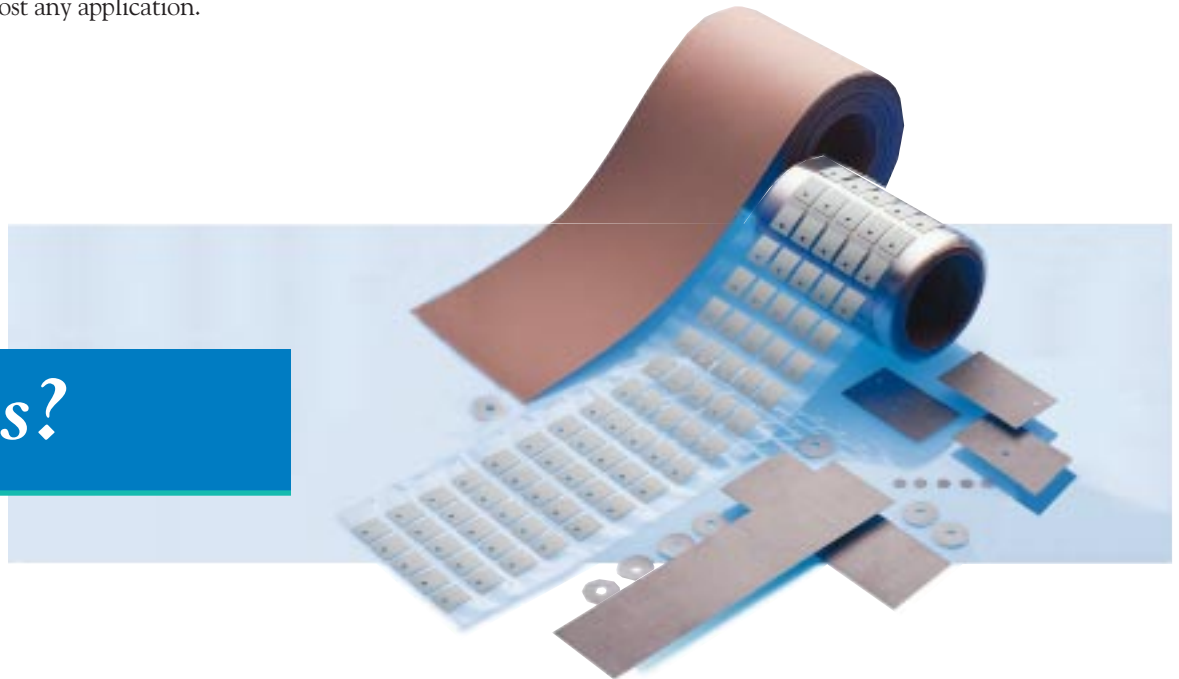

BINDERS

Most Sil-Pad products use silicone rubber as the binder. Silicone rubber has a low dielectric constant, high dielectric strength, good chemical resistance and high thermal stability.

Silicone rubber also exhibits cold flow, which excludes air from the interface as it conforms to the mating surfaces. This flow eliminates the need for thermal grease. A rough surface textured insulator needs to flow more to exclude air than a smooth one. The smoother pads also need less pressure to wet out the surfaces and obtain optimum thermal contact.

THE CARRIER

The carrier provides physical reinforcement and contributes to dielectric strength. High dielectric and physical strength is obtained by using a heavy, tight mesh, but thermal resistance will suffer. A light, open mesh reduces thermal resistance, dielectric strength and cut-through resistance. The carrier materials used in Sil-Pad materials include fiberglass, dielectric film and polyester film which is used in Poly-Pad® materials.

FILLERS

The thermal conductivity of Sil-Pad products is improved by filling them with ingredients of high thermal conductivity. The fillers change the characteristics of the silicone rubber to enhance thermal and/or physical characteristics.

For instance, some fillers make the silicone rubber hard and tough while still retaining the ability to flow under pressure. A harder silicone helps the material resist cut-through. In other applications a filler is used to make the silicone rubber softer and more conformable to rough surfaces. While the range in thermal resistance of greased mica is quite large, the average is comparable to elastomeric insulators filled with a blend of the appropriate ingredients.

- Fiberglass based insulators (Sil-Pad 400®, Sil-Pad 1000® and Sil-Pad 1500®) have a rough surface texture and will show a 15-20% decrease in thermal resistance over a 24 hour period. Film based Sil-Pads (Sil-Pad K-4®, Sil-Pad K-6® and Sil-Pad K-10®) are smoother initially and show a 5% decrease over the same period of time.

Choosing the right Sil-Pad Starts with the



MOUNTING TECHNIQUES AND MOUNTING PRESSURE

Typical mounting techniques include:

- A Spring clip, which exerts a centralized clamping force on the body of the transistor. The greater the mounting force of the spring, the lower the thermal resistance of the insulator
- A screw in the mounting tab. With a screw mounted TO-220, the force on the transistor is determined by the torque applied to the fastener

In extremely low pressure applications, an insulator with pressure sensitive adhesive on each side may give the lowest thermal resistance since the adhesive wets out the interface easier than the dry rubber. This decreases the interfacial thermal resistance.

Devices with larger surface areas need more pressure to get the insulator to conform to the interface than smaller devices. In most screw mount applications, the torque required to tighten the fastener is sufficient to generate the pressure needed for optimum thermal resistance. There are exceptions where the specified torque on the fastener does not yield the optimum thermal resistance for the insulator being used and either a different insulator or a different mounting scheme should be used.

Interfacial thermal resistance decreases as time under pressure increases. In applications where high clamping forces cannot be used, time can be substituted for pressure to achieve lower thermal resistance. *The only way to know precisely what the thermal resistance of an insulator will be in an application is to measure it in that application.*

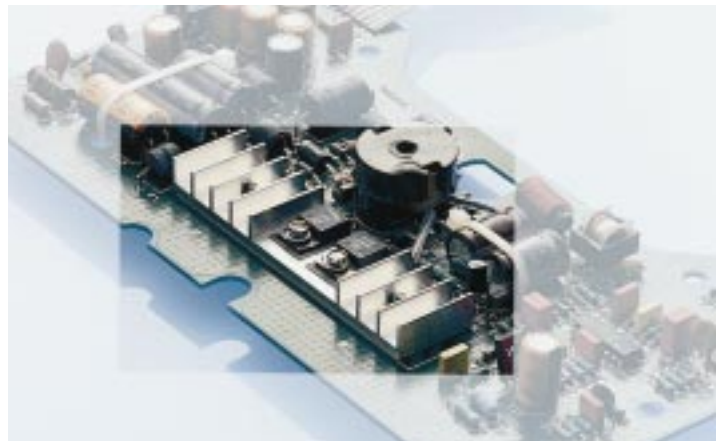

MECHANICAL PROPERTIES

Woven fiberglass and films are used in Sil-Pads to provide mechanical reinforcement. The most important mechanical property in Sil-Pad applications is resistance to cut-through to avoid electrical shorting from the device to the heat sink.

- SPK4[®], SPK6[®] and SPK10[®] are very good at resisting cut-through from sharp burrs left on heat sinks after machining operations such as drilling and tapping
- Fiberglass is good at resisting the type of cut-through encountered when device mounting flanges are pulled into oversized mounting holes. This occurs when fasteners are torqued. (SP400[®], SP1000[®], SP2000[®])

Cut-through resistance is very dependent on the application and depends on several factors:

- A very sharp burr may cause cut-through with less than 100 pounds while a blunt burr may require several hundred pounds to cause cut-through
- When two flat parallel surfaces are brought together on a Sil-Pad, over 1000 pounds of force can be applied without damaging the insulator
- The Poly-Pad insulators are the most mechanically durable Sil-Pads overall. The polyester resin used has a higher modulus than silicone rubber. (Poly-Pad 400[®], Poly-Pad 1000[®], Poly-Pad K4[®] and Poly-Pad K10[®])

Mechanical and Electrical Properties

ELECTRICAL PROPERTIES

If your application does not require electrical insulation Q-Pad II® or Q-Pad 3® are ideal grease replacement materials. These materials do not isolate but have excellent thermal properties.

The most important electrical property in a typical assembly where a Sil-Pad insulator is used is dielectric strength. In many cases the dielectric strength of a Sil-Pad will be the determining factor in the design of the apparatus in which it is to be used.

Here are some general guidelines regarding electrical properties to consider when selecting a Sil-Pad material;

- Q-Pad II and Q-Pad 3 are used when electrical isolation is not required
- Dielectric breakdown voltage is the total voltage that a dielectric material can withstand. When insulating electrical components from each other and ground, it is desirable to use an insulator with a high breakdown voltage

- Breakdown voltage decreases as the area of the electrodes increases. This area effect is more pronounced as the thickness of the insulator decreases
- Breakdown voltage decreases as temperature increases
- Breakdown voltage decreases as humidity increases (SP1750® and SP1950® are less sensitive to moisture)
- Breakdown voltage decreases in the presence of partial discharge
- Breakdown voltage decreases as the size of the voltage source (kVA rating) increases
- Breakdown voltage can be decreased by excessive mechanical stress on the insulator

Dielectric strength, dielectric constant and volume resistivity should all be taken into consideration when selecting a Sil-Pad material. If your application requires special electrical performance please contact the factory for more detailed testing information.

TYPICAL ELECTRICAL PROPERTIES OF SIL-PADS®

Material	Breakdown Voltage (kV)	Dielectric Strength (Volts/mil) (kV/mm)		Dielectric Constant	Volume Resistivity (Ohm-Metre)
SP400®-.007	5	700	18	5.5	10 ¹¹
SP400®-.009	7	800	20	5.5	10 ¹¹
SP1000®	7	700	18	4.5	10 ¹¹
SP2000®	12	800	20	4.0	10 ¹¹
SPK-4®	7	1200	30	5.0	10 ¹²
SPK-6®	7	1200	30	4.0	10 ¹²
SPK-10®	7	1200	30	3.7	10 ¹²
Test Method	ASTM D 149*	ASTM D 149*		ASTM D 150	ASTM D 257
	*Method A, Type 3 Electrodes				

Thermal Properties

Thermal Resistance of Sil-Pad Materials

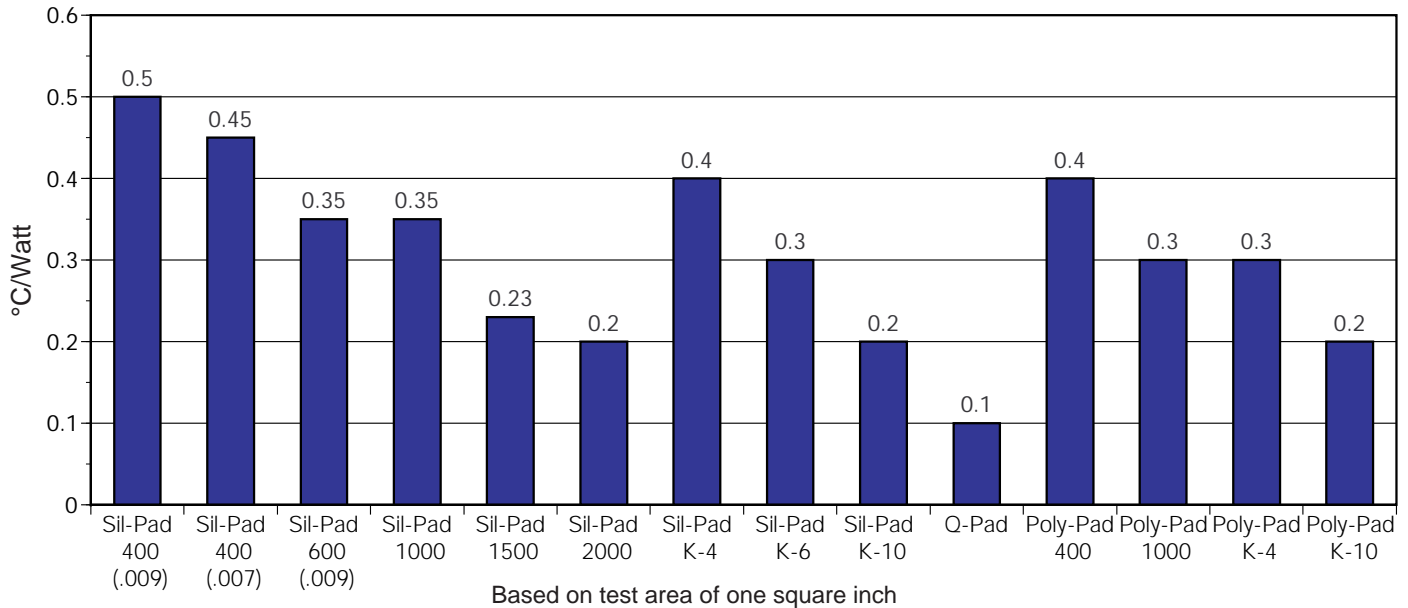

HOW THERMAL PROPERTIES AFFECT YOUR SELECTION

The thermal properties of a Sil-Pad material and your requirements for thermal performance probably have more to do with your selection of a Sil-Pad than any other factor. Discrete Semiconductors, under normal operating conditions, dissipate waste power which raises the junction temperature of the device. Unless sufficient heat is conducted out of the device, its electrical performance and parameters are changed. *A 10° C rise in junction temperature can reduce the mean-time-to-failure of a device by a factor of two. Also, above 25°C, the semiconductor's total power handling capability will be reduced by a derating factor inherent to the device.*

The thermal properties of Sil-Pad products are **thermal impedance, thermal conductivity and thermal resistance**. The thermal resistance and conductivity of Sil-Pad products are inherent to the material and do not change. Thermal resistance and thermal conductivity are measured per ASTM D5470 and do not include the interfacial thermal resistance effects. Thermal impedance applies to the thermal transfer in an application and includes the effects of interfacial thermal resistance. *As the material is applied in different ways the thermal impedance values will vary from application to application.*

- The original Sil-Pad material, Sil-Pad 400® continues to be Bergquist's most popular material for many applications.
- Sil-Pad 1000® is chosen when more thermal performance is required. Sil-Pad 2000® is ideal for high performance, high reliability applications.

Beyond these two standard materials many things can contribute to the selection of the correct material for a particular application. Questions regarding the amount of torque and clamping pressure are often asked when selecting a Sil-Pad material. Here are some guidelines:

- Interfacial thermal resistance decreases as clamping pressure increases.
- The clamping pressure required to minimize interfacial thermal resistance can vary with each type of insulator.
- Sil-Pads with smooth surface finishes (Sil-Pad 600®, Sil-Pad 1500®, Sil-Pad 2000®, Sil-Pad K-4®, Sil-Pad K-6® and Sil-Pad K-10®) are less sensitive to clamping pressure than Sil-Pads with rough surface finishes (Sil-Pad 400® and Sil-Pad 1000®).

Sil-Pad® Applications

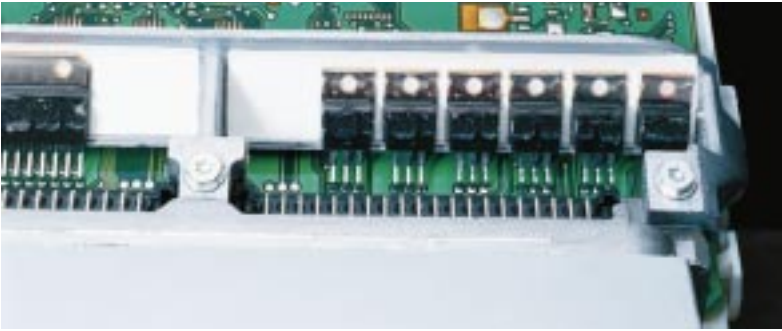

A common Sil-Pad application includes TO-220 transistors mounted in a row on a heat rail.



The application above uses punches parts to insulate the transistors from the mounting bracket and a sheet of Sil-Pad to isolate the mounting brackets from the frame of the assembly.

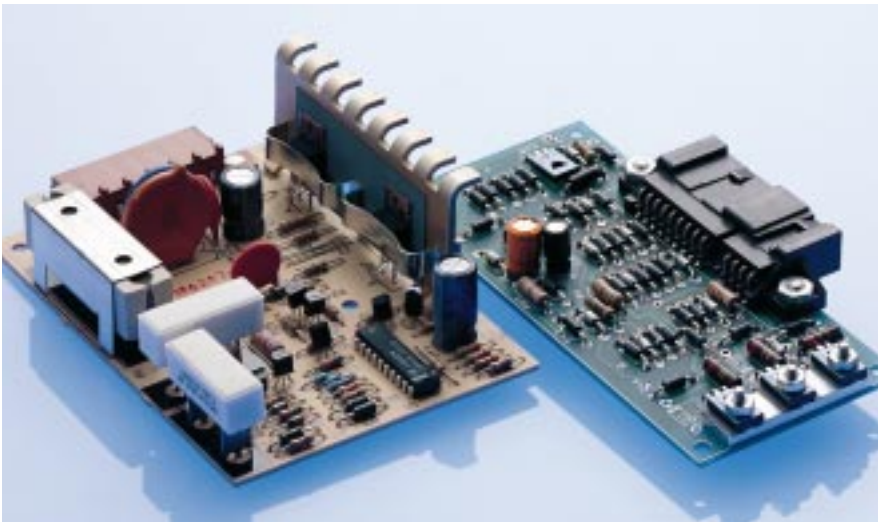

Two different Sil-Pad applications show clip mounting of transistors on the left and screw mounting of transistors to an aluminum bracket on the right.

The circuit board below shows punched parts interfacing screw-mounted transistors to a finned heatsink.

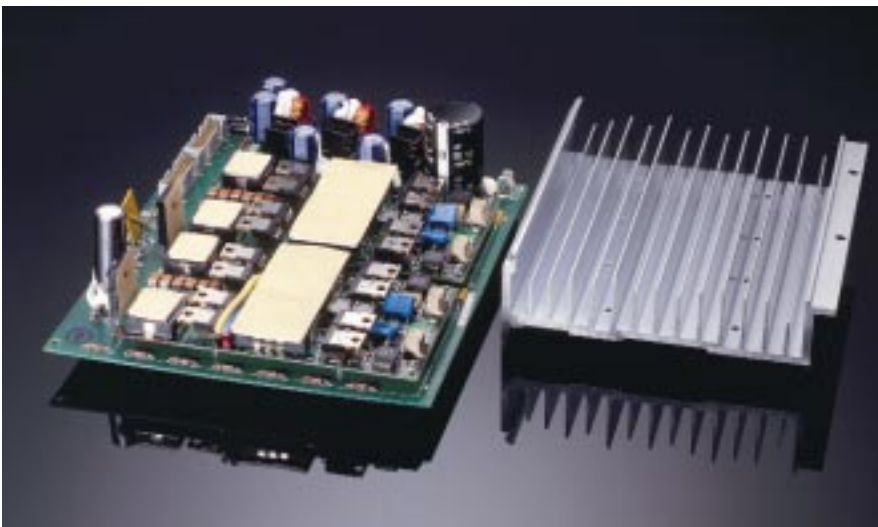

Gap Pad is applied to the top surface of heat generating components in this assembly. A heatsink mounted over the board dissipates heat.

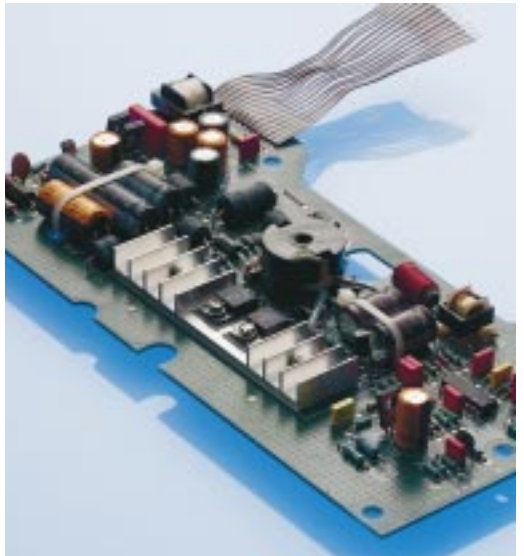

Sil-Pad® Thermally Conductive

	Sil-Pad 400 .007 in	Sil-Pad 400 .009 in	Sil-Pad 600	Sil-Pad 1000	Sil-Pad 1500	Sil-Pad 2000	Sil-Pad K-4
Color	Gray	Gray	Green	Pink	Green	White	Gray
Thickness Inches (mm)	.007 ± .001 (.18 ± .025)	.009 ± .001 (.23 ± .025)	.009 ± .001 (.23 ± .025)	.009 ± .001 (.23 ± .025)	.010 ± .001 (.25 ± .025)	.015 ± .001 (.38 ± .025)	.006 ± .001 (.15 ± .025)
Thermal Resistance, C-in ² /W	.45	.50	0.35	0.35	0.23	0.2	.40
Thermal Conductivity W/m-K nominal	0.9	0.9	1.0	1.2	2.0	3.5	0.9
Voltage Breakdown	3500	4500	4500	4500	4000	4000	6000
Continuous Use Temperature °C	-60 to 180	-60 to 180	-60 to 180	-60 to 180	-60 to 180	-60 to 200	-60 to 180
Construction	Silicone/ Fiberglass	Silicone/ Fiberglass	Silicone/ Fiberglass	Silicone/ Fiberglass	Silicone/ Fiberglass	Silicone/ Fiberglass	Silicone/ Film



SIL-PAD 400®

- The original Sil-Pad material
- Durable silicone rubber and fiberglass construction for excellent mechanical / physical characteristics
- Fiberglass provides excellent cut-through resistance
- Thermal performance improves with age
- Non-toxic and resists damage from cleaning agents
- *Contact the factory for special thicknesses of Sil-Pad 400*

SIL-PAD 1000®

- Specially filled silicone rubber and fiberglass for cut-through resistance
- Low thermal resistance, 33% reduction compared to Sil-Pad 400 material

SIL-PAD 1500®

- Sil-Pad 1500 is a fiberglass reinforced material with enhanced thermal properties
- Designed for high performance thermal applications while meeting specific cost considerations

SIL-PAD 2000®

- For high performance, high reliability military / aerospace and commercial applications
- Sil-Pad 2000 complies with military standards
- Special ingredients maximize thermal and dielectric performance

SIL-PAD K-4®

- Sil-Pad K-4 uses a physically tough, thermally conductive, dielectric film and well-known Sil-Pad rubber.



SIL-PAD K-6®

- Sil-Pad K-6 is a medium performance film based material
- Filled with special ingredients to improve thermal performance
- The film provides a continuous, physically tough dielectric barrier against “cut-through”

SIL-PAD K-10®

- Highest thermal performance of the film based insulators. Minimum thickness helps lower thermal resistance
- Designed to replace brittle, ceramic insulators: Beryllium Oxide, Boron Nitride and Alumina

Q-PAD II®

- Grease replacement material used where electrical insulation is not required
- Q-Pad II is a composite of .0015 in., aluminum foil coated on both sides with a .00225 in., thermally conductive coating
- Q-Pad II eliminates problems associated with grease such as contamination of reflow solder or cleaning operations
- Q-Pad II can be installed prior to these operations. Q-Pad II also eliminates dust collection which can result in surface shorting or heat build-up

Active Insulator Selection Guide

Sil-Pad K-6	Sil-Pad K-10	Q-Pad II	Q-Pad 3	Poly-Pad 400	Poly-Pad 1000	Poly-Pad K-4	Poly-Pad K-10	CPU Pad	Test Method
Bluegreen	Beige	Black	Black	Mauve	Yellow	Mauve	Yellow	Tan	Visual
.006 ± .001 (.15 ± .025)	.006 ± .001 (.15 ± .025)	.006 ± .001 (.15 ± .025)	.005 (.15 mm) .0055 w/ac	.009 ± .001 (.23 ± .025)	.009 ± .001 (.23 ± .025)	.006 ± .001 (.15 ± .025)	.006 ± .001 (.15 ± .025)	.005 ± .001	ASTM D 374
.30	0.2	0.1	0.1	0.4	0.3	0.4	0.2	0.3	ASTM D5470
									ASTM D 5470
1.1	1.3	2.5	2.0	0.9	0.12	0.9	1.3	0.6	
6000	6000	N/A	N/A	4500	2500	6000	6000	N/A	ASTM D 149
-60 to 180	-60 to 180	-60 to 180	-60 to 180	-20 to 150	-20 to 150	-20 to 150	-20 to 150		-
Silicone/ Film	Silicone/ Film	Silicone/ Alum Foil	Silicone/ Fiberglass	Polyester/ Fiberglass	Polyester/ Fiberglass	Polyester/ Film	Polyester/ Film	Filled Polymer	-



Q-PAD 3®

- Grease replacement material where electrical insulation is not required
- Q-Pad 3 consists of graphite imbedded in a polymer matrix
- When exposed to modest heat and pressure, the elastomer conforms to surface textures thereby creating an air free interface between surfaces
- Q-Pad 3 is fiberglass reinforced and withstands processing stresses without losing physical integrity

CPU-PAD®

- Bergquist CPU Pad is a thermally conductive, polymer based bonding material used to permanently mount a heatsink on top of a central processing unit
- The material will adhere to the heatsink or integrated circuit with moderate heat and pressure, forming a bond between components

POLY-PAD MATERIALS

- Polyester based Poly-Pad 400®, Poly-Pad 1000®, Poly-Pad K-4® and Poly-Pad K-10®
- Designed for silicone sensitive applications
- Ideally suited for applications requiring conformal coatings or applications where silicone contamination is a concern (telecommunications and aerospace applications)

SIL-PAD 800-S® SIL-PAD 900-S®

- Designed for low cost applications requiring high thermal performance
- These applications also typically have low mounting pressures for component clamping
- Sil-Pad 800-S material combines a smooth surface design with high thermal conductivity and electrical insulation
- Applications include discrete semiconductors (TO-220, TO-247 and TO-218) mounted with spring clips



SIL-PAD SHIELD®

- Bergquist Sil-Pad Shield is a bonded laminate of thermally conductive, electrically isolating Sil-Pad 400 or Sil-Pad 1000 pads with a copper shield between the layers. It is supplied with a pretinned solder point for easy grounding

HI-FLOW™ 105

The Grease Replacement Material with Thermal Resistance Equal to Grease

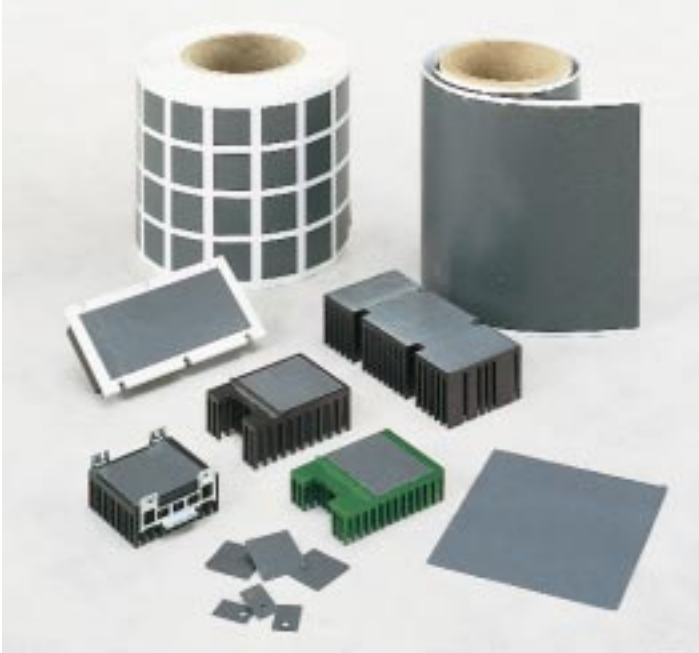

HI-FLOW™ 105 is the new “phase change” material designed specifically to replace grease as a thermal interface. Bergquist Hi-Flow 105 is a filled polymer which is now available in a pad form for easier handling and installation. At 65C Hi-Flow 105 changes from a solid and flows (Phase Change Temperature) thereby assuring total wet-out of the interface. The thixotropic characteristics of the material keep Hi-Flow 105 from flowing out of the interface. The result is a thermal interface comparable to grease, without the mess, contamination and difficult handling associated with grease.

HI-FLOW™ 105 has thermal performance equal to grease with .05°C-in²/W contact thermal resistance.

HI-FLOW™ 105 is used in applications where electrical isolation is not required.

Typical applications for Hi-Flow 105 include CPUs mounted on a heat sink, power conversion modules or any other spring or clip mount application where grease is used.

HI-FLOW™ 105 is coated on both sides of the aluminum substrate. The product is available as a dry material or with thermal acrylic adhesive on one side to aid in positioning.

HI-FLOW™ 105 features include:

- Available in pad form as punched parts, sheets or rolls
- Low volatility - less than 1%
- Easy to handle in the manufacturing environment
- Flows but doesn't run like grease or wax under continuous heat or in vertical applications
- Low contact thermal resistance of 0.05 C-in²/W.
- Tack free at room temperature. Does not attract contaminants
- Scratch resistant at room temperature. Does not require protective liner in shipment when attached to heat sink.

Bergquist Hi-Flow™ 105

Physical Properties	Typical Value	Test Method
Color	Dark Gray	Visual
Substrate	Aluminum	
Thickness of Substrate	0.0015 in. 0.04 mm	ASTM D374
Thickness of Thermal Acrylic Adhesive	0.0005* (one side) 0.0127 mm	ASTM D374
Thickness of Material	0.0055* ± .001* 0.14 mm	ASTM D374
Specific Gravity of Coating	1.8	ASTM D792
Phase Change Temperature (°C)	65	
Continuous Use Temperature (°C)	-30 to +130	

Thermal / Electrical Properties	Typical Value	Test Method
Thermal Resistance (°C-in ² -W ⁻¹) (C-mm ² /watt)	<0.05 w/o AC <.32 w/o AC	ASTM D5470*
Thermal Resistance (°C-in ² -W ⁻¹) (C-mm ² /watt)	0.05 w/AC 0.32 w/AC	
Thermal Conductivity of Coating w-m/K	0.9	ASTM D5470*
Dielectric Constant of Coating (100 Hz)	3.2	ASTM D150

* Modified ASTM D5470 test method used. Sample run at 70°C

HI-FLOW™ 625

Electrically Insulating, Thermally Conductive Phase Change Material

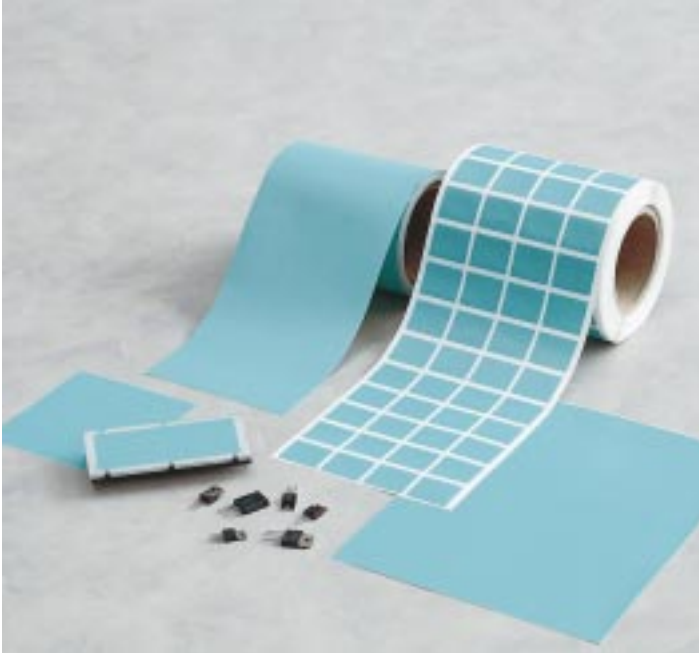

Bergquist Hi-Flow 625 is a film reinforced phase change material. The product consists of a thermally conductive 65°C phase change compound coated on an electrically insulating film. Hi-Flow 625 is designed to be used as a thermal interface material between electronic power devices that require electrical isolation and a heat sink. The film reinforcement makes Hi-Flow 625 easy to handle, and the 65°C phase change temperature of the coating material eliminates shipping and handling problems. Hi-Flow 625 has a continuous use temperature of 150°C.

HI-FLOW™ 625 is coated on both sides of the Bergquist proprietary film substrate.

HI-FLOW™ 625 is used in applications where electrical insulation is required.

HI-FLOW™ 625 handles like a Sil-Pad® at room temperature, and flows like high quality grease at elevated temperature.

HI-FLOW™ 625 is Tack Free at production temperatures.

HI-FLOW™ 625 is Scratch Resistant at production temperature and does not require a protective liner in most shipping situations.

HI-FLOW™ 625 has the thermal performance of 2-3 mil mica and grease assemblies.

HI-FLOW™ 625 is available in punch parts, sheets or rolls, with or without pressure sensitive adhesive.

Bergquist Hi-Flow™ 625

Physical Properties	Typical Value (mm)	Test Method
Color	Green	Visual
Thickness of Substrate	0.005 in. (0.13)	ASTM D 374
Tensile Strength	30 Kpsi (210 Mpa)	ASTM D 882A
Elongation	60%	ASTM D 882A
Phase Change Temperature	65°C	DSC
Continuous Use Temperature	150°C	

Thermal

Thermal Cond. of Coating	0.8 W/m-K	ASTM D5470
Thermal Cond. of Composite	0.4 W/m-K	ASTM D5470 ¹
Thermal Resistance (°C-in ² -W ⁻¹)	0.25 C-in ² /W (1.6 C-cm ² /W)	ASTM D5470

Electrical

Breakdown Voltage	4000 Volt	ASTM D149
Dielectric Constant, 100HZ	3.5	ASTM D150
Volume Resistivity	>10 ¹⁰ ohm-m	ASTM D257

Adhesive

Peel Strength	70 g/in (28 g/cm)	ASTM D1876
Release Peel	25 g/in (10 g/cm)	ASTM D1876

1. Sample run at 70°C.

**No Preheat of
Heat Sink
Required**

HI-FLOW™ 115-AC

Phase Change Thermal Interface Material for Computer Processors

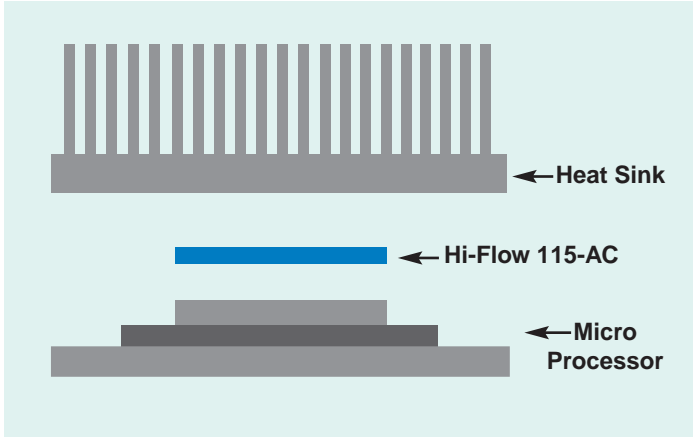

Bergquist Hi-Flow 115 AC is a thermally conductive fiber reinforced phase change material. The product consists of a thermally conductive 65°C phase change compound coated on a fiberglass web, and an adhesive coating one side for attachment to cold heat sink. Hi-Flow 115 is designed as a thermal interface material between a computer processor and a heat sink. The pressure sensitive adhesive makes it simple to apply in high volume to heat sinks and the 65°C phase change temperature eliminates shipping and handling problems.

HI-FLOW™ 115 AC can be applied directly to a COLD heat sink. No need to preheat the heat sink to apply the Hi-Flow 115 AC.

HI-FLOW™ 115 AC requires no protective liner for shipping or handling. The HF 115 coating is tough at room temperature, and it can withstand the handling and shipping process without protection.

HI-FLOW™ 115 AC handles like a Sil-Pad® at room temperature and flows like high quality grease at elevated temperature.

HI-FLOW™ 115 AC thermal resistance of 0.18°C in²/watt at 50 psi.

HI-FLOW™ 115 AC is available without adhesive for slightly better thermal performance. The thermal resistance is 0.15°C in²/watt at 50 psi.

Bergquist Hi-Flow™ 115-AC

Physical Properties	Typical Value (mm)	Test Method
Color	Gray	Visual
Tensile Strength	900 psi (6.3 MPa)	ASTM D882A
Elongation, 45°	40% (40%)	ASTM D882A
Thickness	.0055" .15mm	ASTM D374
Phase Change Temperature	65°C	DSC
Continuous Use Temperature	150°C	

Thermal

Thermal Conductivity	0.8 W/m-K	ASTM D5470
Thermal Resistance ¹	0.18 °C-in ² /W	ASTM D5470

Electrical

Breakdown Voltage ²	300 Volt	ASTM D149
Dielectric Constant, 100HZ	3.5	ASTM D150
Volume Resistivity	>10 ¹⁰ ohm-m	ASTM D257

Adhesive

Peel Strength	70 g/in	ASTM D1876
Release Peel	25 g/in	ASTM D1876

1. Sample run at 70°C.

2. Not recommended as an insulator.

Automated, Greaseless Thermal Interface



The new Bergquist Softface eliminates problems associated with thermal grease such as contamination of electronic assemblies and reflow solder baths. Softface may be installed prior to soldering and cleaning, without worry.

Softface is supplied on a polyester film. The material is transferred to a heat sink or device using commercial hot-stamping equipment.

With Softface applied to a component or other surface you have a built-in thermal interface. Rapid assembly of the material eliminates labor and Softface has the same thermal resistance as grease.

Softface can be supplied already applied to a heat sink or other surface in the assembly. The heat sink or other part can be sent to the factory and Softface will be applied by Bergquist before shipping to the customer for pre-production quantities.

If rework is required, the heat sink or component can be removed and then reused without replacing Softface.

Rolls and Sheets

Softface material is available in roll form only. Hot-stamp equipment will accommodate many different roll sizes. For more information on hot-stamping equipment and techniques please contact the factory.

TYPICAL PROPERTIES OF SOFTFACE™

Property	Insulating Value	Non-Insulating Value	Supplier Measurement Method
Thickness, inches	.005 & .008	.003 / .005 & .008	ASTM D374
Color	White	Black	Visual
Thermal Conductivity, W/m-K	3.5	3.5	ASTM D5470
Thermal Resistance, C-in ² /W	.06/.09	.06/.09	ASTM D5470
Volume Resistivity, Ohm-Cm	10 ¹⁰	10 ¹	ASTM D257 ASTM D4496
Dielectric Constant, @ 1 KHz	4	Non-Insulating	ASTM D150
Dielectric Strength, V/mil	500	NA	ASTM D149
Manufacturing Requirements			
Storage Life, @ 25°C	1 year (min)	1 year (min)	--
Cleanability Alcohol (IPA)	Water and/or Isopropyl Alcohol (IPA)	Water and/or Isopropyl --	

Conformable, Thermally Conductive Material for Filling Air Gaps



Gap Pad VO is a thermally conductive material that acts as a thermal interface between a heat sink and an electronic device. The conformable nature of Gap Pad VO allows the pad to fill in air gaps between PC boards and heat sinks or a metal chassis.

Gap Pad VO is a highly conformable, low modulus polymer on a fiberglass carrier. The material is available in thicknesses from .020" to .160" with a liner applied to the pink side of the material. The range in thicknesses and the materials flexibility allow Gap Pad VO to be used in a variety of applications where surface textures vary and the space between surfaces is uneven. The material is available in die-cut parts and with or without adhesive.

Applications

- Areas where heat needs to be transferred to the frame or other type of heat spreader
- Between a CPU and a heat spreader
- Between a semiconductor and heat sink
- Replacement for messy grease

U.L. File Number E59150

Die-Cut parts, and Sheets

Gap Pad is available in die-cut parts and sheets. Standard sheet size is 8" x 16". Gap Pad is not available in rolls.

Property	Value	Value	Test Method	
Mechanical Properties				
Thickness inches	.020" to .160"		ASTM D374	
Color	Yellow/Pink		Visual	
Specific Gravity	1.6		ASTM D792	
Heat Capacity J/g-K	1		ASTM C351	
Continuous Use	-60 to +200C			
Hardness, entire composite	vs. Thickness (in)	(Type 00)	ASTM D2240	
		0.020		80
		0.040		65
		0.060		65
		0.080		55
		0.100		50
		0.125		45
		0.160		40
Young's Modulus (psi) vs. Rate of Strain (inches/minute)* Area = 0.5 in ²	Rate	Modulus	ASTM D575	
		0.01		200
		0.1		300
		1.0		400
Low Modulus Portion Only	10.0	800		

Stress vs. strain and resultant deflection in mils for each Gap Pad VO thickness.

Example: Rate = 1 in/min. Modulus = stress/strain = 400 psi, Area = 0.5 in², Low Modulus Portion Only;

Stress	Strain	20 mil	40 mil	60 mil	80 mil	100 mil	125 mil	160 mil	
4 psi	1%	0.15	0.35	0.55	0.71	0.91	1.16	1.51	ASTM D575
8 psi	2%	0.30	0.70	1.10	1.42	1.82	2.32	3.02	
20 psi	5%	0.75	1.75	2.75	3.55	4.55	5.80	7.55	
40 psi	10%	1.50	3.50	5.50	7.10	9.10	11.6	15.1	
80 psi	20%	3.00	7.00	11.0	14.2	18.2	23.2	30.2	
200 psi	50%	7.50	17.5	27.5	35.5	45.5	58.0	75.5	

Electrical Properties

Dielectric Constant	5.5	ASTM D150
Dielectric Breakdown Voltage kV-AC	>6	ASTM D149
Volume Resistivity, Ohm-meters	10 ¹¹	ASTM D257

Thermal Properties

Thermal Conductivity @ 10 psi, W/m-K	0.8	ASTM D5470		
Thermal Resistance** vs. Entire composite	Thickness (in.)	(C-in ² /W)	ASTM D5470	
		0.020		1.0
		0.040		2.0
		0.060		3.0
		0.080		4.0
		0.100		5.0
		0.125		6.2
		0.160		8.0

MODULUS * The modulus of Gap Pad is shown as being rate dependent because Gap Pad is viscoelastic. At high rates of compression Gap Pad is elastic and at low rates it is viscous. Elastic strain is instantaneous, independent of time. The total deformation occurs at the instant the stress is applied and is completely recovered when the stress is released. Viscous strain is time dependent. The deformation is not instantaneous but occurs over time and is not completely recovered after the stress is removed. As an example, if the low modulus Gap Pad rubber is molded into a ball and dropped on the floor it will bounce. However, if a load is placed on the ball for a long period of time it will flatten out to a certain extent and will not recover completely to its original shape after the load has been removed.

THERMAL RESISTANCE ** With Gap Pad, the thermal resistance is dependent on the gap between the device and the heatsink. The engineer can minimize the thermal resistance by designing the gap as small as possible. A Gap Pad thickness is then chosen to be just thick enough to fill the largest gaps while minimizing the deflection needed in the smallest gaps to decrease the stress exerted on the devices. If the size of the gaps are known, the thermal resistance across each gap is determined from the table of thermal resistance vs. thickness.

Conformable, Thermally Conductive Material for Filling Air Gaps

Gap Pad VO Soft is recommended for low stress applications. These include applications where the material is used as an interface and one side is in contact with a leaded device.

Gap Pad VO Soft is a thermally conductive material that acts as a thermal interface between a heat sink and an electronic device. The conformable nature of Gap Pad VO Soft allows the pad to fill in air gaps between PC boards and heat sinks or a metal chassis.

Gap pad VO Soft is a highly conformable, low modulus silicone polymer filled with alumina on a fiberglass carrier. The material is available in thicknesses from 0.020" to 0.160" with a liner applied to the light pink side of the material. The range in thicknesses and the materials flexibility allow Gap Pad VO Soft to be used in a variety of applications where surface texture vary and the space between surfaces is uneven. The material is available in die-cut parts and sheets. Standard sheet size is 8" X 16", with or without adhesive.

To calculate the approximate amount of deflection for a specific material thickness, at a given pressure, refer to the graph below. Multiply the thickness of the material by the percentage at the given pressure.*

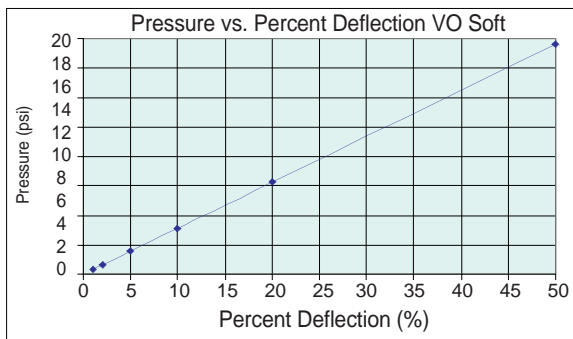

The resultant thickness of the Gap Pad will determine the thermal resistance. Subtracting the initial gap pad thickness by the deflection value, obtained above, will give the resultant thickness. Refer to the graph below to obtain the thermal resistance of the material.

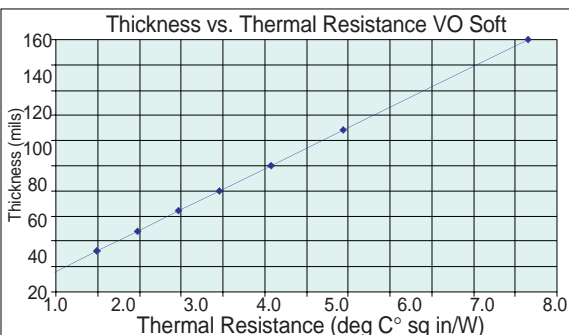

Applications

- Between chassis wall and other surface
- CDROM Cooling
- Area where heat needs to be transferred to a frame, chassis, or other type of heat spreader.
- Between CPU and Heat Spreader
- Between a semiconductor and heat sink

Property	Value	Test Method
Mechanical Properties		
Thickness inches	.020" to .160"	ASTM D374
Color	Mauve/Pink	Visual
Specific Gravity	1.6	ASTM D792
Heat Capacity J/g-K	1.0	ASTM C351
Continuous Use Temp.	-60°C to +200°C	
Hardness (Shore Type OO)	vs. Thickness (in)	(Type OO) ASTM D2240
	0.020"	65 to
	0.160"	25
Young's Modulus* (psi)	Rate	Modulus ASTM D575
	0.01	40

Electrical Properties		
Dielectric Breakdown Voltage	>6 kV	ASTM D149
Dielectric Constant	5.5	ASTM D150
Volume Resistivity	10" Ohm-meter	ASTM D257
Thermal Properties		
Thermal Conductivity @ 10 psi	0.8 W/m-K	ASTM D5470
Flame Rating		
Film #: E59150	94V-O	U.L.

MODULUS * The modulus of Gap Pad VO is rate dependent due to its viscoelastic properties. At high rates of compression Gap Pad is elastic and at low rates it is viscous. The elastic strain (deflection) is not time dependent. A completely elastic material, when compressed will recover 100% to its original shape when the force is released. Viscous strain, however, is time dependent. Deformation is not instantaneous but occurs over time and is not completely recovered after the stress is removed. As an example; if Gap Pad is molded into a ball and dropped, it will bounce, and rebound close to 100%. However, if a load is placed on the ball for a long period of time it will flatten out a degree and will not recover completely to its original shape when the load is removed. For more information on Gap Pad modulus refer to Bergquist Application Note #116.

*Graphs and data generated from Young's Modulus, calculated using 0.01 inch/min. step rate of strain with a sample size of 0.79 inch².

GAP PAD VO ULTRA SOFT™

Conformable, Thermally Conductive Material for Filling Air Gaps

Gap Pad VO Ultra Soft is a cost-effective material, recommended for extremely low stress applications that require a thermally conductive interface material. The highly conformable nature of the material allows the pad to fill in air voids and air gaps between PC boards and heat sinks or metal chassis with steps, rough surfaces, and high stack up tolerances. The viscoelastic nature of the material also gives excellent low stress vibration dampening and shock absorbing characteristics.

GP Ultra Soft is an electrically isolating material, which allows its use in applications requiring isolation between heat sinks and high voltage, bare leaded devices.

GP Ultra Soft is a filled thermally conductive polymer supplied on a rubber coated fiberglass carrier allowing for easy material handling and enhanced puncture, shear, and tear resistance.

GP Ultra Soft is offered in thicknesses from 0.020" to 0.250" with the rubber-coated carrier on one side and removable protective liner on the naturally tacky side of the material. Material is available in die-cut parts and sheets, 0.020" material is also offered in roll form. Standard sheet size is 8" X 16", with or without adhesive, thickness tolerance is $\pm 5\%$ of material thickness.

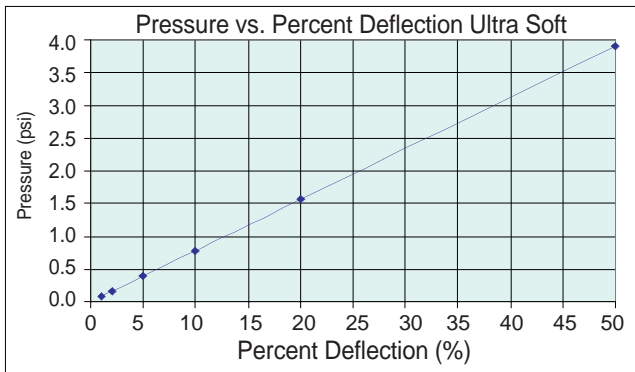

The resultant thickness of the Gap Pad will determine the thermal resistance. Subtracting the initial gap pad thickness by the deflection value, obtained above, will give the resultant thickness. Refer to the graph below to obtain the thermal resistance for a given thickness of material.

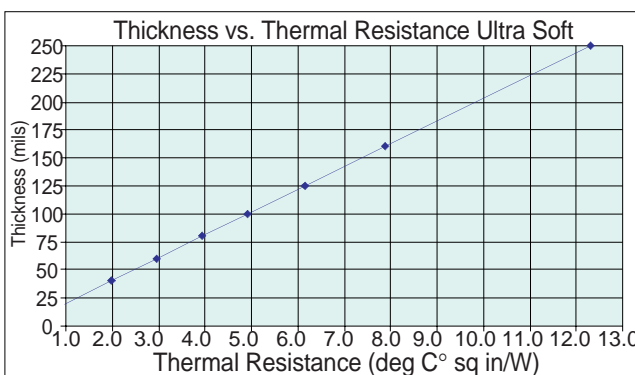

To calculate the approximate amount of deflection at a given pressure, refer to the first graph. Multiply the thickness of the material by the percentage at the given applied pressure.*

Typical Applications

- Between chassis wall and other surface
- CDROM Cooling
- Area where heat needs to be transferred to a frame, chassis, or other type of heat spreader
- Between a CPU and Heat Spreader
- Between a semiconductor and heat sink

Bergquist Gap Pad VO Ultra Soft

Physical Properties	Typical Value (mm)	Test Method
Color	Mauve/Pink	Visual
Thickness of Substrate	0.020" to .250"	ASTM D374
Specific Gravity	1.6	ASTM D792
Heat Capacity	1.0 J/g-K	ASTM D351
Continuous Use Temperature	-60°C - 200°C	
Hardness (Shore Type 00)	Thickness	Hardness
	0.020" to 0.250"	55 to 15
Young's Modulus* (psi)	Rate: 0.01 Modulus: 8	ASTM D575
Thermal		
Thermal Conductivity (@10 psi)	1 W/m-K	ASTM D5470
Electrical		
Breakdown Voltage	>6 kV	ASTM D149
Dielectric Constant	5.5	ASTM D150
Volume Resistivity	10 ¹¹ ohm-m	ASTM D257

MODULUS * The modulus of Gap Pad VO is rate dependent due to its viscoelastic properties. At high rates of compression Gap Pad is elastic and at low rates it is viscous. The elastic strain (deflection) is not time dependent. A completely elastic material, when compressed will recover 100% to its original shape when the force is released. Viscous strain, however, is time dependent. Deformation is not instantaneous but occurs over time and is not completely recovered after the stress is removed. As an example; if Gap Pad is molded into a ball and dropped, it will bounce, and rebound close to 100%. However, if a load is placed on the ball for a long period of time it will flatten out a degree and will not recover completely to its original shape when the load is removed. For more information on Gap Pad modulus refer to Bergquist Application Note #116.

*Graphs and data generated from Young's Modulus, calculated using 0.01 inch/min. step rate of strain with a sample size of 0.79 inch².

GAP PAD™ 1500

High Thermally Conductive Gap Filling Material

Gap Pad 1500 is designed to cost-effectively maximize heat transfer from electronic components to heat sinks or heat spreaders. The material has an ideal filler blend that gives it's low modulus characteristic yet maintains optimal thermal performance, the combination of which minimizes thermal resistance between heat generating devices and heat sinks.

GP1500 is an electrically isolating material that allows its use in applications requiring isolation between heat sinks and high voltage, bare leaded devices.

GP1500 is a highly conformable low-modulus material that fills air gaps due to steps, rough surfaces, and high stack-up tolerances. The softness relieves stress and absorbs shocks minimizing damage

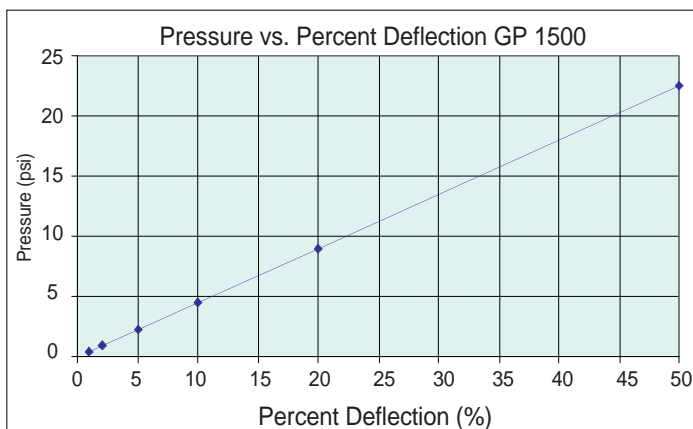

The resultant thickness of the Gap Pad will determine the thermal resistance. Subtracting the initial gap pad thickness by the deflection value, obtained above, will give the resultant thickness. Refer to the graph below to obtain the thermal resistance for a given thickness of material.

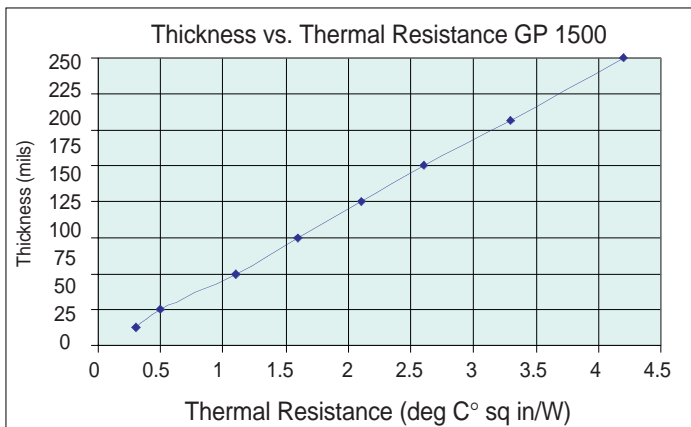

To calculate the approximate amount of deflection for a specific material thickness, at a given pressure, refer to the graph. Multiply the thickness of the material by the percentage at the given pressure.*

to delicate leads. The tacky nature of both sides of the material allows for good compliance to adjacent surfaces of components, minimizing interfacial resistance.

GP1500 is available in thicknesses from 0.020" to 0.200".

The standard material is offered without reinforcement, however, the 0.015" and 0.020" thick material is also offered with reinforcement denoted as GP1500R.

Typical Applications

- Heat Pipe Assemblies
- RDRAM™ Memory Modules
- CDROM Cooling
- Area where heat needs to be transferred to a frame, chassis, or other type of heat spreader.
- Between a CPU and Heat Spreader

Bergquist Gap Pad 1500

Physical Properties	Typical Value	Test Method
Color	Black	Visual
Thickness of Substrate	0.020" to 0.200"	ASTM D374
Specific Gravity	2.1	ASTM D792
Heat Capacity	1.0 J/g-K	ASTM D351
Continuous Use Temperature	-60°C - 200°C	
Hardness (Shore Type 00)	40	ASTM D2240
Young's Modulus* (psi)	Rate 0.01"/min.	Modulus 45 ASTM D575

Thermal

Thermal Conductivity (@10 psi) 1.5 W/m-K ASTM D5470

Electrical

Dielectric Breakdown Voltage	>6 kVAC	ASTM D149
Dielectric Constant	5.5	ASTM D150
Volume Resistivity	10 ¹¹ Ohm-meter	ASTM D257

UL Recognized

94V-O (94V-1 for 20 mil) File #: E59150

*Graphs and data generated from Young's Modulus, calculated using 0.01 inch/min. step rate of strain with a sample size of 0.79 inch². For more information on Gap Pad modulus refer to Bergquist Application Note #116.

Gap Pad 1500 is available in die-cut parts and in roll form (converted or unconverted). The material is compatible with dispensing equipment for high volume production.

GAP PAD™ 1500R

High Thermally Conductive Gap Filling Material

Gap Pad 1500R has the same highly conformable low modulus polymer as the standard GP1500 family of products with the addition of a fiberglass reinforcing substrate in the center. The fiberglass enforcement allows for easy material handling and enhances puncture, shear, and tear resistance.

GP1500R is an electrically isolating material that allows its use in applications requiring isolation between heat sinks and high voltage, bare leaded devices.

GP1500R has an ideal polymer and filler blend that gives it's low modulus characteristic yet maintains optimal thermal performance, minimizing thermal resistance. The highly

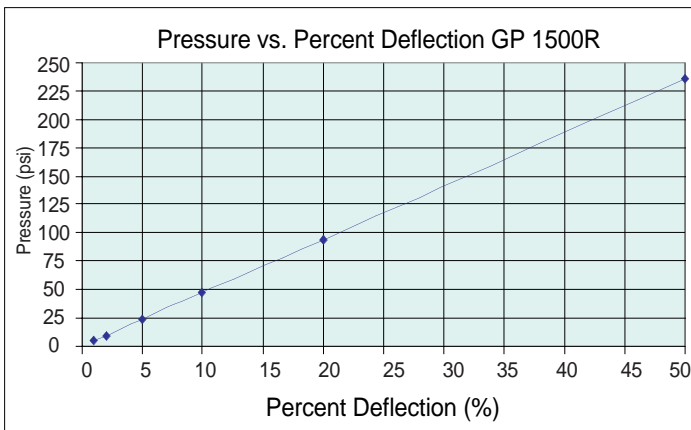

The resultant thickness of the Gap Pad will determine the thermal resistance. Subtracting the initial gap pad thickness by the deflection value, obtained above, will give the resultant thickness. Refer to the graph below to obtain the thermal resistance for a given thickness of material.

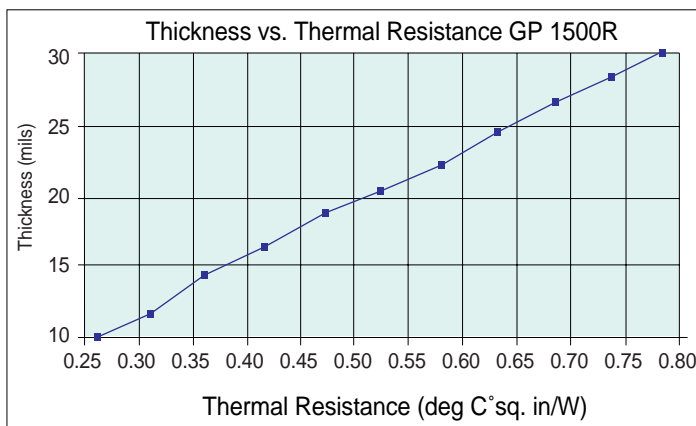

To calculate the approximate amount of deflection for a specific material thickness, at a given pressure, refer to the top graph. Multiply the thickness of the material by the percentage at the given pressure.*

conformable low-modulus nature of the material fills air gaps due to rough surfaces and high stack-up tolerances and is also vibration dampening. The tacky nature of both sides of the material allows for good compliance to mating surfaces of components, further reducing thermal resistance.

GP1500R is available in 0.010" to 0.030" thicknesses and is available in 8" x 16" sheets, die-cut parts, and rolls in converted or unconverted form. The material is compatible with dispensing equipment for high volume production.

Typical Applications

- Heat Pipe Assemblies
- RDRAM™ Memory Modules
- CDROM Cooling
- Area where heat needs to be transferred to a frame, chassis, or other type of heat spreader.
- Between a CPU and Heat Spreader

Bergquist Gap Pad 1500R

Physical Properties	Typical Value	Test Method
Color	Black	Visual
Thickness of Substrate	0.010" to 0.030"	ASTM D374
Specific Gravity	2.1	ASTM D792
Heat Capacity	1.3 J/g-K @ 85°C	ASTM D351
Continuous Use Temperature	-60°C - 200°C	
Hardness (Shore Type 00)	75 (@ 20 mils)	ASTM D2240
Young's Modulus* (psi)	Rate: 0.01"/min. Modulus: 45	ASTM D575

Thermal

Thermal Conductivity (@10 psi)	1.5 W/m-K	ASTM D5470
--------------------------------	-----------	------------

Electrical

Dielectric Breakdown Voltage	>6 kV	ASTM D149
Dielectric Constant	6.0	ASTM D150
Volume Resistivity	10 ¹¹ Ohm-meter	ASTM D257

UL Recognized

94V-O (pending)

*Graphs and data generated from Young's Modulus @ 10% deflection, calculated using 0.01 inch/min. step rate of strain with a sample size of 0.79 inch² and 20 mils thick. For more information on Gap Pad modulus refer to Bergquist Application Note #116.

High Performance Thermally Conductive Gap Filling Material

Gap Pad 2000 is a highly conductive filled low modulus polymer that acts as a thermal interface between electrical components and heat sinks. The conformable nature allows the material to fill air gaps to enhance the thermal performance of electrical systems. The tacky nature of both sides of the material allows for good compliance to the adjacent surfaces of components. This high thermally conductive reinforced material is available in thicknesses from 0.010" to 0.125".

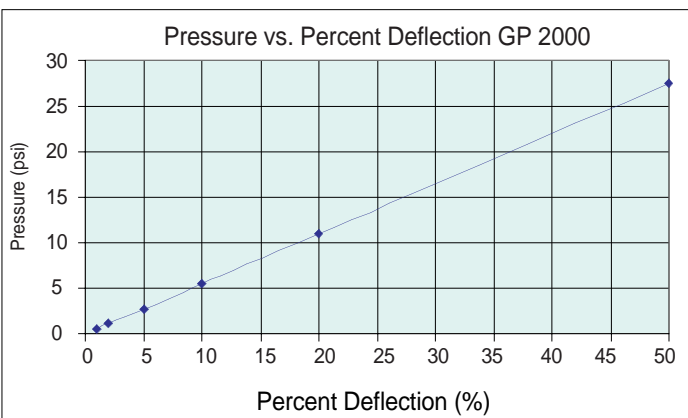

To calculate the approximate amount of deflection for a specific material thickness, at a given pressure, refer to the graph above. Multiply the thickness of the material by the percentage at the given pressure.*

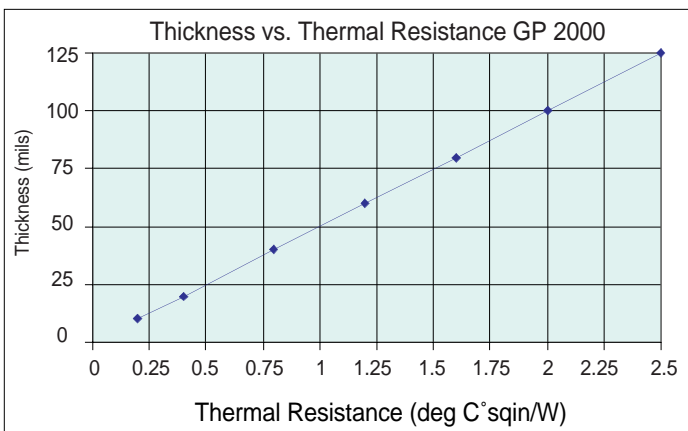

The resultant thickness of the Gap Pad will determine the thermal resistance. Subtracting the initial gap pad thickness by the deflection value, obtained above, will give the resultant thickness. Refer to the second graph to obtain the thermal resistance for a given thickness of material.

Typical Applications

- Heat Pipe Assemblies
- RDRAM™ Memory Modules
- CDROM Cooling
- Area where heat needs to be transferred to a frame, chassis, or other type of heat spreader.
- Between a CPU and Heat Spreader

Bergquist Gap Pad 2000

Physical Properties	Typical Value	Test Method	
Color	Grey	Visual	
Thickness of Substrate	0.010" to 0.125"	ASTM D374	
Specific Gravity	2.9	ASTM D792	
Heat Capacity	1.0 J/g-K	ASTM C351	
Continuous Use Temperature	-60°C to 200°C		
Hardness (Shore Type 00)	Thickness	Hardness	
	0.010"		80
	to 0.125"		to 50
Young's Modulus* (psi)	Rate 0.01"/min.	Modulus 55	
		ASTM D2240	
		ASTM D575	

Thermal

Thermal Conductivity (@10 psi)	2.0 W/m-K	ASTM D5470
--------------------------------	-----------	------------

Electrical

Dielectric Breakdown Voltage	>3 kV	ASTM D149
Dielectric Constant	5	ASTM D150
Volume Resistivity	10 ¹¹ Ohm-meter	ASTM D257
UL Recognized	94V-O (pending)	U.L.

*Graphs and data generated from Young's Modulus, calculated using 0.01 inch/min. step rate of strain with a sample size of 0.79 inch². For more information on Gap Pad modulus refer to Bergquist Application Note #116.

Gap Pad 2000 is available in die-cut parts and in roll form (converted or unconverted). The material is compatible with dispensing equipment for high volume production.

GAP PAD™ 3000

Enhanced High Performance Gap Filling Material

Gap Pad 3000 is a highly conductive filled polymer that acts as a thermal interface between electrical components and heat sinks. This material maintains a conformable nature, which allows it to fill air gaps and enhance the thermal performance of electrical systems.

Gap Pad 3000 is an electrically isolating material, which allows its use in applications requiring isolation between heat sinks and high voltage, bare leaded devices.

Gap Pad 3000 is a filled thermally conductive polymer supplied on a rubber carrier allowing for easy material handling and enhanced puncture, shear, and tear resistance.

Gap Pad 3000 is inherently tacky on one side for stick-in-place application, while having a non blocking surface on the other.

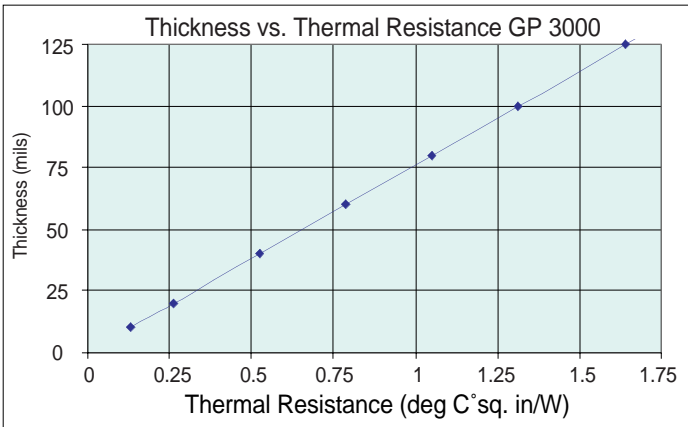

Thermal resistance is dependent on material thickness. Refer to the graph above to obtain the thermal resistance of the material.

Typical Applications

- CPU & Heat Pipe Assemblies
- Drive Cooling
- CDROM Cooling
- Area where heat needs to be transferred to a frame, chassis, or other type of heat spreader.
- Between CPU and Heat Spreader

Bergquist Gap Pad 3000

Physical Properties	Typical Value	Test Method	
Color	Gold	Visual	
Thickness of Substrate	0.010" to 0.125"	ASTM D374	
Specific Gravity	3.2 g/cc	ASTM D792	
Heat Capacity	1.0 J/g-K	ASTM C351	
Continuous Use Temperature	-60°C to 200°C		
Hardness (Shore Type 00)	Thickness	Hardness	ASTM D2240
	0.010" to 0.125"	85 to 55	
Young's Modulus* (psi)	Rate: 0.01"/min. Modulus: 64	ASTM D575	

Thermal

Thermal Conductivity (@10 psi)	3.0 W/m-K	ASTM D5470
--------------------------------	-----------	------------

Electrical

Dielectric Breakdown Voltage	>10 kV	ASTM D149
Dielectric Constant	7	ASTM D150
Volume Resistivity	10 ¹¹ Ohm-meter	ASTM D257
UL Recognized	94V-O (pending)	U.L.

*Graphs and data generated from Young's Modulus, calculated using 0.01 inch/min. step rate of strain with a sample size of 0.79 inch². For more information on Gap Pad modulus refer to Bergquist Application Note #116.

Gap Pad 3000 is available in die-cut parts and in roll form (converted or unconverted). The material is compatible with dispensing equipment for high volume production.

GAP PAD™ HC 1100

Gap Filling Material with “Gel-Like” Modulus, One Sided Tack

HC1100 is a cost-effective material, recommended for extremely low stress applications that require a thermally conductive interface material. The highly conformable nature of the material allows the pad to fill in air voids and air gaps between heat generating devices and heat sinks or metal chassis with rough surfaces, steps, and high stack up tolerances. This thermally conductive reinforced material is available in thicknesses from 0.010" to 0.020".

HC1100 is offered with tack on the bottom side only! This material simplified material handling for part dispensing and pick-and-place automation. The top, tack-free surface does not require a protective liner since it does not attract dust and dirt from surrounding areas.

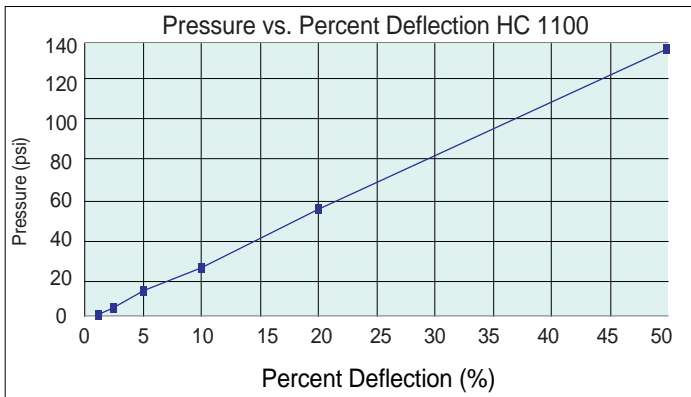

To calculate the approximate amount of deflection for a specific material thickness, at a given pressure, refer to the graph above. Multiply the thickness of the material by the percentage at the given pressure.*

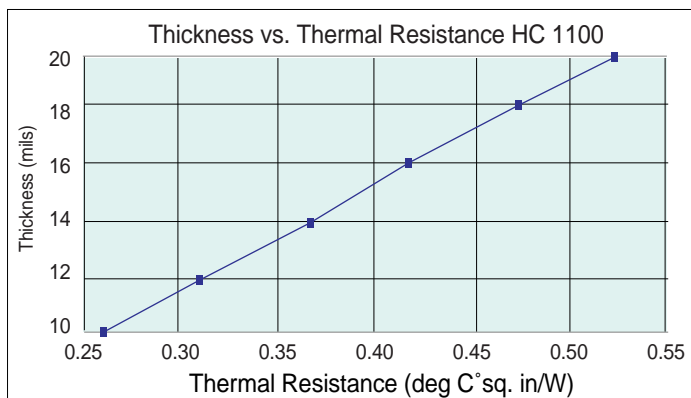

The resultant thickness of the HC1100 will determine the thermal resistance. Subtracting the initial HC1100 thickness by the deflection value, obtained above, will give the resultant thickness. Refer to the graph above to obtain the thermal resistance of the material.

HC1100 is viscoelastic, which gives it excellent low stress vibration dampening and shock absorbing characteristics.

HC1100 is an electrically isolating material, allowing for its use between high voltage, bare leaded devices and metal sinks.

HC1100 is a filled thermally conductive polymer supplied with an imbedded reinforcement resulting in improved material handling and enhanced puncture, shear, and tear resistance.

Typical Applications

- Areas where irregular surfaces need to make a thermal interface to a heat sink
- RDRAM™ Memory Modules
- Between CPU's and Heat Spreaders
- For ASIC and PC Cooling
- Heat interfaces to frames, chassis, or other heat spreading devices

Bergquist Gap Pad HC 1100

Physical Properties	Typical Value	Test Method
Color	Grey	Visual
Thickness of Substrate	0.010" to 0.020"	ASTM D374
Specific Gravity	1.6	ASTM D792
Heat Capacity	1.0 J/g-K	ASTM C351
Continuous Use Temperature	-60°C to 200°C	
Hardness (Shore Type 00)	Hardness 60 (@ 20 mils)	ASTM D2240
Young's Modulus* (psi)	Rate 0.01"/min. Modulus 15	ASTM D575
Thermal		
Thermal Conductivity (@10 psi)	1.0 W/m-K	ASTM D5470
Flame Rating	94V-1 (pending)	U.L.
Electrical		
Dielectric Breakdown Voltage	>5 kV	ASTM D149
Dielectric Constant	6	ASTM D150
Volume Resistivity	10 ¹¹ Ohm-meter	ASTM D257
UL Recognized	94V-O (pending)	U.L.

*Graphs and data generated from Young's Modulus, calculated using 0.01 inch/min. step rate of strain with a sample size of 0.79 inch². For more information on Gap Pad modulus refer to Bergquist Application Note #116.

Gap Pad HC 1100 is available in die cut –parts and in roll form (converted or unconverted). The material is compatible with dispensing equipment for high volume production.

GAP FILLER 1000

Thermally Conductive Liquid Gap Filling Material

Gap Filler 1000 is a high performance thermally conductive liquid GAP FILLING MATERIAL. It is supplied as a two-component, room or elevated temperature curing system. It is formulated to provide a balance of cured material properties highlighted by "gel-like" modulus and good compression set (memory). These properties result in a soft, thermally conductive, form-in-place elastomer ideal for coupling "hot" electronic components mounted on PC boards with an adjacent metal case or heat sink. The viscosity of the mixed uncured material also makes it suitable as a thermally conductive alternative in the following applications:

- Replacement for thermal grease – Before cure, it flows under pressure like a grease. After cure, it does not pump from the interface as a result of thermal cycling. Unlike thermal grease, the cured product is dry to the touch.
- As a low modulus thermally conductive potting material.
- As a thermally conductive vibration dampening material.

Gap Filler 1000 is supplied as a two-part kit comprised of Part A and Part B components. The two components are colored to assist as a mix indicator (1:1 ratio by weight or volume). The mixed system will cure at either ambient or elevated temperature to form a soft thermally conductive interface material. Unlike cured Gap Filling materials, the liquid approach offers infinite thickness with little or no stress during displacement. It also eliminates the need for specific pad thickness and die-cut shapes for individual applications.

Gap Filler 1000 is intended for use in thermal interface applications where a structural bond is not a requirement. This material is formulated for low cohesive strength and "gel-like" properties.

This product is characterized by these special properties:

- High Thermal Conductivity – 1.0 W/m-K
- Stress Absorbing Flexibility (low modulus)
- "Clean-Release" from many heat sink and electronic packaging materials (re-workable)
- Excellent Low and High Temperature Mechanical and Chemical Stability
- 100% Solids – No Cure By-Products
- Versatile Cure Schedules – Both Ambient and Accelerated Cure Schedules

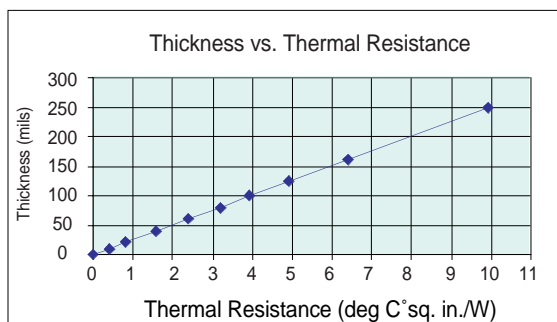

Applications

Gap Filler 1000 can be applied using the following methods:

- Mixed and dispensed using dual tube cartridge packs with static mixers and a manual or pneumatic gun
- Mixed and dispensed using industry standard high volume mixing and dispensing equipment

Bergquist Gap Filler 1000

Physical Properties	Typical Value	Test Method
As Supplied		
Appearance Part A	Grey	Visual
Appearance Part B	White	Visual
Viscosity As Mixed ¹	400,000 cps	ASTM
Specific Gravity (Part A & B)	1.63	ASTM D792
Mix Ratio	1:1	
Shelf Life @ 25°C	6 months	

As Cured - Physical		
Appearance	Grey	Visual
Hardness ²	20	ASTM D2240
Cont. Use Operating Temp	-60°C to +200°C	
Heat Capacity	1 J/g-K	ASTM C351
Thermal Conductivity	1.0 W/mK	ASTM D5470
Flame Rating	94 VO Pending	

As Cured - Electrical		
Dielectric Strength	500 Volts/mil	ASTM D149
Volume Resistivity	1E+14 ohm-cm	ASTM D257
Dielectric Constant	5 @ 1 MHz	ASTM D150

Cure Schedule		
Pot Life @ 25°C	15 min ³	
Cure @ 25°C	60 to 120 min ⁴	
Cure @ 100°C	5 min ⁴	

¹ Brookfield RV, Heli-Path, Spindle TF @ 2 rpm, 25° C

² Shore Hardness Type "OO"

³ Time for viscosity to double

⁴ Cure Schedule (Rheometer – Time to reach 90% cure)

Gap Filler 1000 is available in 50 cc, 200 cc, or 400 cc MixPac™ cartridges. It is also available in 2 Quart, 2 Gallon, and 10 Gallon Kits.

GAP FILLER 1000U

Thermally Conductive Liquid Gap Filling Material (Non-Silicone)

Gap Filler 1000U is a high performance thermally conductive liquid NON-SILICONE GAP FILLING MATERIAL. It is supplied as a two-component, room temperature curing system. It is formulated to provide a balance of cured material properties highlighted by "gel-like" modulus and good compression set (memory). These properties result in a soft, thermally conductive, form-in-place elastomer ideal for coupling "hot" electronic components mounted on PC boards with an adjacent metal case or heat sink. The viscosity of the mixed uncured material also makes it suitable as a thermally conductive alternative in the following applications:

- Replacement for thermal grease – Before cure, it flows under pressure like a grease. After cure, it does not pump from the interface as a result of thermal cycling. Unlike thermal grease, the cured product is dry to the touch.
- As a low modulus thermally conductive potting material.
- As a thermally conductive vibration dampening material.

Gap Filler 1000U is supplied as a two-part kit comprised of Part A and Part B components. The two components are colored to assist as a mix indicator (10:1 ratio by volume). The mixed system will cure at ambient temperature to form a soft thermally conductive interface material. Unlike cured Gap Filling materials, the liquid approach offers infinite thickness variations with little or no stress during displacement. It also eliminates the need for specific pad thickness and die-cut shapes for individual applications.

Gap Filler 1000U is intended for use in thermal interface applications where a structural bond is not a requirement. This material is formulated for low cohesive strength and "gel-like" properties.

This product is characterized by these special properties:

- High Thermal Conductivity – 1.0 W/m-K
- Stress Absorbing Flexibility (low modulus)
- "Clean-Release" from many heat sink and electronic packaging materials (re-workable)
- Excellent Low and High Temperature Mechanical and Chemical Stability
- 100% Solids – No Cure By-Products

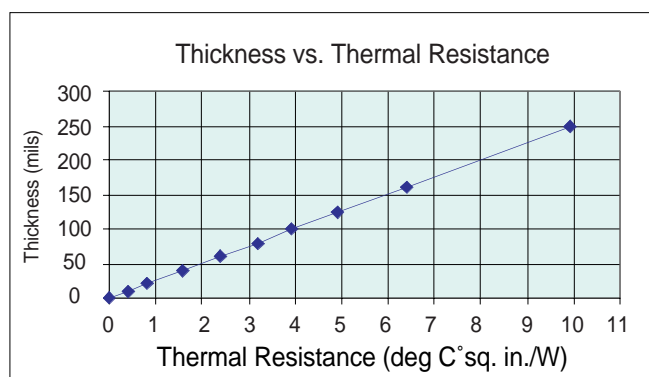

Applications

Gap Filler 1000U can be applied using the following methods:

- Mixed and dispensed using dual tube cartridge packs with static mixers and a manual or pneumatic gun
- Mixed and dispensed using industry standard high volume mixing and dispensing equipment

Bergquist Gap Filler 1000U

Physical Properties	Typical Value	Test Method
As Supplied		
Appearance Part A	White	Visual
Appearance Part B	Clear	Visual
Viscosity As Mixed ¹	125,000 cps	ASTM
Specific Gravity (as mixed)	2.3	ASTM D792
Mix Ratio	10:1	
Shelf Life @ 25°C	6 months	

As Cured - Physical		
Appearance	White	Visual
Hardness ²	70 - 80	ASTM D2240
Cont. Use Operating Temp	-60°C to +120°C	
Heat Capacity	1.0 J/g ⁻¹ ·K ⁻¹	ASTM C351
Thermal Conductivity	1.0 W·m ⁻¹ ·K ⁻¹	ASTM D5470
Glass Transition	-60°C	DSC

As Cured - Electrical		
Dielectric Strength	400 Volts/mil ⁻¹	ASTM D149
Volume Resistivity	>1E+8 ohm-cm	ASTM D257
Dielectric Constant	5 @ 1 MHz	ASTM D150

Cure Schedule		
Pot Life @ 25°C ³	45 - 60 min	
Cure @ 25°C ⁴	4 - 6 hours	

¹ Brookfield RV, Heli-Path, Spindle TF @ 2 rpm, 25° C

² Shore Hardness Type "OO"

³ Working life of material as a liquid

⁴ Cure Schedule (Rheometer – Time to reach 90% cure)

Recommended to cure at Room Temperature for 24 hours before exposing to temperatures above 80°C.

Gap Filler 1000U is available in 37 cc, 250 cc, or 490 cc MixPac™ cartridges. It is also available in 1.1 Gallon, and 5.5 Gallon Kits.

GAP FILLER 2000

High Performance Thermally Conductive Liquid Gap Filling Material

Gap Filler 2000 is a high performance thermally conductive liquid GAP FILLING MATERIAL. It is supplied as a two-component, room or elevated temperature curing system. It is formulated to provide a balance of cured material properties highlighted by "gel-like" modulus and good compression set (memory). These properties result in a soft, thermally conductive, form-in-place elastomer ideal for coupling "hot" electronic components mounted on PC boards with an adjacent metal case or heat sink. The viscosity of the mixed uncured material also makes it suitable as a thermally conductive alternative in the following applications:

- Replacement for thermal grease – Before cure, it flows under pressure like a grease. After cure, it does not pump from the interface as a result of thermal cycling. Unlike thermal grease, the cured product is dry to the touch.
- As a low modulus thermally conductive potting material.
- As a thermally conductive vibration dampening material.

Gap Filler 2000 is supplied as a two-part kit comprised of Part A and Part B components. The two components are colored to assist as a mix indicator (1:1 ratio by weight or volume). The mixed system will cure at either ambient or elevated temperature to form a soft thermally conductive interface material. Unlike cured Gap Filling materials, the liquid approach offers infinite thickness with little or no stress during displacement. It also eliminates the need for specific pad thickness and die-cut shapes for individual applications.

Gap Filler 2000 is intended for use in thermal interface applications where a structural bond is not a requirement. This material is formulated for low cohesive strength and "gel-like" properties.

This product is characterized by these special properties:

- High Thermal Conductivity – 2.0 W/m-K
- Stress Absorbing Flexibility (low modulus)
- "Clean-Release" from many heat sink and electronic packaging materials (re-workable)
- Excellent Low and High Temperature Mechanical and Chemical Stability
- 100% Solids – No Cure By-Products
- Versatile Cure Schedules – Both Ambient and Accelerated Cure Schedules

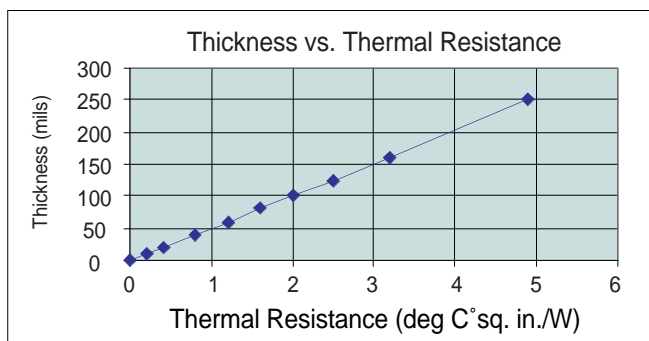

Applications

Gap Filler 2000 can be applied using the following methods:

- Mixed and dispensed using dual tube cartridge packs with static mixers and a manual or pneumatic gun
- Mixed and dispensed using industry standard high volume mixing and dispensing equipment

Bergquist Gap Filler 2000

Physical Properties	Typical Value	Test Method
As Supplied		
Appearance Part A	Pink	Visual
Appearance Part B	White	Visual
Viscosity As Mixed ¹	500,000 cps	
Specific Gravity (Part A & B)	2.8	ASTM D792
Mix Ratio	1:1	
Shelf Life @ 25°C	6 months	

As Cured - Physical

Appearance	Pink	Visual
Hardness ²	75	ASTM D2240
Cont. Use Operating Temp	-60°C to +200°C	
Heat Capacity	1 J/g-K	ASTM C351
Thermal Conductivity	2.0 W/mK	ASTM D5470
Flame Rating	94 VO Pending	

As Cured - Electrical

Dielectric Strength	500 Volts/mil	ASTM D149
Volume Resistivity	1E+14 ohm-cm	ASTM D257
Dielectric Constant	7 @ 1 MHz	ASTM D150

Cure Schedule

Pot Life @ 25°C	15 min ³
Cure @ 25°C	60 to 120 min ⁴
Cure @ 100°C	5 min ⁴

¹ Brookfield RV, Heli-Path, Spindle TF @ 2 rpm, 25° C

² Shore Hardness Type "OO"

³ Working life of material as a liquid

⁴ Cure Schedule (Rheometer – Time to reach 90% cure)

Gap Filler 2000 is available in 50 cc, 200 cc, or 400 cc MixPac™ cartridges. It is also available in 2 Gallon and 10 Gallon Kits.

GAP FILLER 2000U

Thermally Conductive Liquid Gap Filling Material (Non-Silicone)

Gap Filler 2000U is a high performance thermally conductive liquid NON-SILICONE GAP FILLING MATERIAL. It is supplied as a two-component room temperature or elevated temperature curing system. It is formulated to provide a balance of cured material properties highlighted by "gel-like" modulus and good compression set (memory). These properties result in a soft, thermally conductive, form-in-place elastomer ideal for coupling "hot" electronic components mounted on PC boards with an adjacent metal case or heat sink. The viscosity of the mixed uncured material also makes it suitable as a thermally conductive alternative in the following applications:

- Replacement for thermal grease – Before cure, it flows under pressure like a grease. After cure, it does not pump from the interface as a result of thermal cycling. Unlike thermal grease, the cured product is dry to the touch.
- As a low modulus thermally conductive potting material.
- As a thermally conductive vibration dampening material.

Gap Filler 2000U is supplied as a two-part kit comprised of Part A and Part B components. The two components are colored to assist as a mix indicator (10:1 ratio by volume). The mixed system will cure at ambient temperature or elevated temperature to form a soft thermally conductive interface material. Unlike cured Gap Filling materials, the liquid approach offers infinite thickness variations with little or no stress during displacement. It also eliminates the need for specific pad thickness and die-cut shapes for individual applications.

Gap Filler 2000U is intended for use in thermal interface applications where a structural bond is not a requirement. This material is formulated for low cohesive strength and "gel-like" properties.

This product is characterized by these special properties:

- High Thermal Conductivity – 2.0 W/m-K
- Stress Absorbing Flexibility (low modulus)
- "Clean-Release" from many heat sink and electronic packaging materials (re-workable)
- Excellent Low and High Temperature Mechanical and Chemical Stability
- 100% Solids – No Cure By-Products

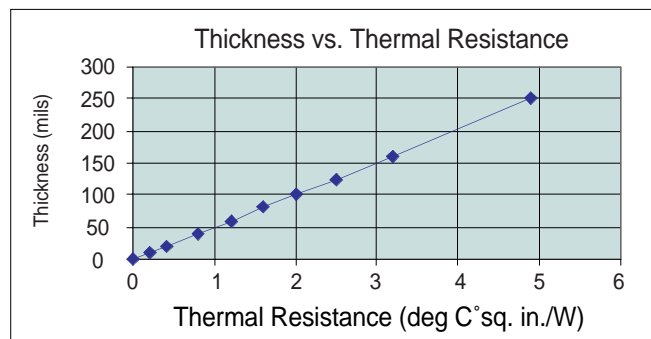

Applications

Gap Filler 2000U can be applied using the following methods:

- Mixed and dispensed using dual tube cartridge packs with static mixers and a manual or pneumatic gun
- Mixed and dispensed using industry standard high volume mixing and dispensing equipment

Bergquist Gap Filler 2000U

Physical Properties	Typical Value	Test Method
As Supplied		
Appearance Part A	Blue	Visual
Appearance Part B	Clear	Visual
Viscosity As Mixed ¹	600,000 cps	ASTM
Specific Gravity (as mixed)	2.8	ASTM D792
Mix Ratio	10:1	
Shelf Life @ 25°C	6 months	

As Cured - Physical		
Appearance	White	Visual
Hardness ²	80 - 90	ASTM D2240
Cont. Use Operating Temp	-60°C to +120°C	
Heat Capacity	0.9 J/g ⁻¹ -K ⁻¹	ASTM C351
Thermal Conductivity	1.9 W-m ⁻¹ -K ⁻¹	ASTM D5470
Glass Transition	-60°C	DSC

As Cured - Electrical		
Dielectric Strength	400 Volts/mil ⁻¹	ASTM D149
Volume Resistivity	>1E+8 ohm-cm	ASTM D257
Dielectric Constant	5 @ 1 MHz	ASTM D150

Cure Schedule		
Pot Life @ 25°C ³	45 - 60 min	
Cure @ 25°C ⁴	4 - 6 hours	

¹ Brookfield RV, Heli-Path, Spindle TF @ 2 rpm, 25° C

² Shore Hardness Type "OO"

³ Working life of material as a liquid

⁴ Cure Schedule (Rheometer – Time to reach 90% cure)
Recommended to cure at or below 90°C

Gap Filler 2000U is available in 37 cc, 250 cc, or 490 cc MixPac™ cartridges. It is also available in 1.1 Gallon, and 5.5 Gallon Kits.

BOND PLY™ 100

Thermally Conductive, Pressure Sensitive Adhesive Tape

Bergquist Bond Ply 100 is a thermally conductive, double-sided pressure sensitive adhesive tape. The tape consists of a high performance, thermally conductive acrylic adhesive coated with a fiberglass reinforced interweave. Bond Ply 100 is designed to attain high bond strength to a variety of surfaces, and to maintain high bond strength with long term exposure to moderate heat and high humidity.

Use Bond Ply 100 for:

- Mounting a heat sink to a BGA graphic processor
- Mounting a heat sink to a computer processor
- Mounting a heat sink to a drive processor
- Mounting a heat spreader to a power converter PCB
- Mounting a heat spreader to a motor control PCB

Use Bond Ply 100 instead of:

- Heat Cure Adhesive
- Screw Mounting
- Clip Mounting

Bond Ply 100 is available in standard thickness of 5, 8 and 11 mil. In the case that these thicknesses will not work for your application, Bergquist will coat a custom thickness of 4 to 12 mils.

Bond Ply 100 is available in sheets, rolls and die-cut parts. Standard sheet size is 10" by 10". Standard roll size is 10" by 300'. Die-cut parts can be supplied on rolls and as individual parts.

Bergquist Bond Ply 100

Physical Properties	Typical Value	Test Method
Color	White	Visual
Short Term Temp Resistance	200°C	
Continuous Use Temp	-30°C to +120°C	
Elongation, 45° Warp	70%	ASTM D412
Tape Tensile Strength	0.9 Kpsi	ASTM D412
CTE	325 ppm	TMA
Glass Transition	-30°C	DSC

Adhesion Strengths

Lap shear	100 psi	ASTM D1002
Lap shear, 5 hrs @ 100°C	200 psi	ASTM D1002
Lap shear, 2 min @ 200°C	200 psi	
Static Dead Weight Shear	150°C	PSTC#7

Thermals

Thermal Conductivity	0.8 W/m-K	ASTM D5470
----------------------	-----------	------------

Typical Properties of Bond Ply 100

Property	Test Method	Bond Ply 105	Bond Ply 108	Bond Ply 111
Thickness Inches	ASTM D374	0.005 (0.13)	0.008 (0.20)	0.011 (0.28)
Thermal Resistance, °C in ² /watt	ASTM D5470	0.3	0.5	ASTM D 1458
Thermal Impedance, °C in ² /watt	ASTM D5470*	0.6	0.8	1.0
Breakdown Voltage, KVAC	ASTM D149	3	6.5	8.5
Surface Flatness, inch/inch		0.001	0.002	0.0025
Application		PCB	Processors	Processors

*Single Layer test that includes interfacial thermal resistance

SIL-PAD 400®

The Original Fiberglass Based Sil-Pad

SIL-PAD 400

Sil-Pad 400 is the original Sil-Pad material. Sil-Pad 400 is a composite of silicone rubber and fiberglass. It is flame retardant and is specially formulated for use as a thermally conductive insulator. Primary use is to electrically isolate power sources from heat sinks.

Sil-Pad 400 has excellent mechanical and physical characteristics. Surfaces are pliable and allow complete surface contact with excellent heat dissipation. Sil-Pad 400 actually improves its thermal resistance with age. The reinforcing fiberglass gives excellent cut-through resistance and Sil-Pad 400 is non-toxic and resists damage from cleaning agents.



SIL-PAD 600

Sil-Pad 600 is a silicone elastomer filled with special ingredients to provide higher thermal performance. This material has similar physical characteristics of the Sil-Pad 400 material with enhanced thermal performance.

Special Thicknesses, Rolls and Sheets

Sil-Pad 400 can be supplied on special order in a variety of thicknesses from .007 to .045 inches to fulfill special requirements of insulation path minimums or other spacing needs. Sil-Pad 400 and 600 are available in die-cut parts, sheets (6" x 6" min., 6" x 12", 8" x 8", 10" x 10" and 12" x 12") and roll form.

Physical Properties	Sil-Pad 400, .007 in.	Sil-Pad 400, .009 in	Sil-Pad 600	Test Method
Color	Gray	Gray	Green	
Thickness Inches (mm)	.007 ± .001" 0.178 ± 0.025	.009 ± .001" .229 ± .025	.009 ± .001" .229 ± .025	ASTM D 374
Breaking Strength Lbs/inch (kN/m)	100 (18)	100 (18)	100 (18)	ASTM D 1458
Elongation, % 45° to warp and fill	40	40	40	ASTM D 412
Hardness, Shore A	85	85	85	ASTM D 2240
Tensile Strength, kPsi (MPa) 45° to warp and fill		3 (20)	3 (20)	ASTM D 412
Continuous Use Temp., °C	-60 to +180	-60 to +180	-60 to +180	
Specific Gravity	2.0	2.0	1.8	ASTM D 792
Construction	Silicone/Fiberglass	Silicone/ Fiberglass		
Thermal Vacuum Weight Loss % (TML) as manufactured Post Cure 24 Hrs. 400 °F	.40 .25	.40 .25		NASA SP-R-0022A
Volatile Condensable Material % (CVCM) as manufactured Post Cure 24 Hrs. 400°F	.11 .07	.11 .07		NASA SP-R-0022A

Thermal Properties	Sil-Pad 400, .007 in.	Sil-Pad 400, .009 in	Sil-Pad 600	Test Method
Thermal Resistance, °C-in ² /W	0.45	0.50	0.35	ASTM D 5470
Thermal Conductivity, W/m-K	0.9	0.9	1.0	ASTM D 5470

Electrical Properties	Sil-Pad 400, .007 in.	Sil-Pad 400, .009 in	Sil-Pad 600	Test Method
Breakdown Voltage, Volts a-c Min.	3500	4500	4500	ASTM D 149
Dielectric Constant, 1000 Cps (Hz)	5.5	5.5	5.0	ASTM D 150
Volume Resistivity, Ohm Metre	1.0 x 10 ¹¹	1.0 x 10 ¹¹	1.0 x 10 ¹¹	ASTM D 257

FILM BASED

Sil-Pad K-4®, Sil-Pad K-6® and Sil-Pad K-10®

SIL-PAD K-4®

Sil-Pad K-4 uses a specially developed film which has high thermal conductivity, high dielectric strength and is very durable. Sil-Pad K-4 combines the thermal transfer properties of well known Sil-Pad rubber with the physical properties of a film. The result is a durable insulator that withstands high voltages, requires no thermal grease to transfer heat, is available in customized shapes and sizes and saves time and costs while increasing productivity.

SIL-PAD K-6®

Sil-Pad K-6 is a medium performance film based thermally conductive insulator. The film is coated with a silicone elastomer to deliver high performance and provides a continuous physically tough dielectric barrier against “cut-through” and resultant assembly failures.

Die-Cut parts, Rolls and Sheets

Sil-Pad K-4, K-6 and K-10 are available in die-cut parts, sheets (6" x 6" min., 6" x 12", 8" x 8", 10" x 10" and 12" x 12") and roll form.

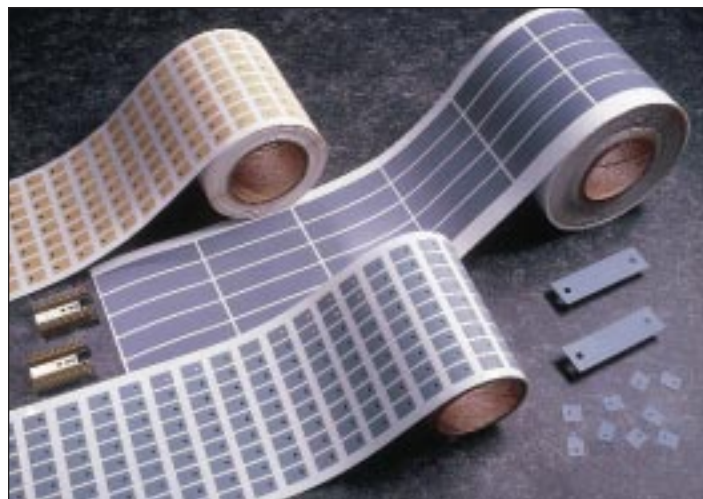

SIL-PAD K-10®

Bergquist Sil-Pad K-10 is the high performance insulator. It combines special film with a filled silicone rubber. The result is a product with good cut-through properties and excellent thermal performance.

K-10 is designed to replace ceramic insulators such as Beryllium Oxide, boron Nitride and Alumina. These insulators are expensive and they break easily. K-10 eliminates breakage and costs much less than ceramics.

Physical Properties	Sil-Pad K-4	Sil-Pad K-6	Sil-Pad K-10	Test Method
Color	Gray	Bluegreen	Beige	Visual
Thickness Inches (mm) (.15 ±.025)	.006 ± .001 (.15 ±.025)	.006 ± .001 (.15 ±.025)	.006 ± .001 ASTM D 374	
Breaking Strength Lbs/inch (kN/m)	30 (5)	30 (5)	30 (5)	ASTM D 1458
Elongation, % 45° to warp and fill	40	40	40	ASTM D 412
Hardness, Shore A	90	90	90	ASTM D 2240
Tensile Strength, kPsi (MPa)	5 (35)	5 (35)	5 (35)	ASTM D 412
Thermal Vacuum Weight Loss % (TML) as manufactured	.26		.36	NASA SP-R-0022A
Continuous Use Temp., °C	-60 to +180	-60 to +180	-60 to +180	--
Construction	Silicone/Film	Silicone/Film	Silicone/Film	
Volatile Condensable Material % (CVCM) as manufactured	.07		.09	NASA SP-R-0022A
Thermal Properties	Sil-Pad K-4	Sil-Pad K-6	Sil-Pad K-10	Test Method
Thermal Resistance, °C-in ² /W	0.40	0.30	0.2	ASTM D 5470
Thermal Conductivity, W/m-K	0.9	1.1	1.3	ASTM D 5470
Electrical Properties	Sil-Pad K-4	Sil-Pad K-6	Sil-Pad K-10	Test Method
Breakdown Voltage, Volts a-c Min.	6000	6000	6000	ASTM D 149
Dielectric Constant, 1000 Cps (Hz)	5.0	4.0	3.7	ASTM D 150
Volume Resistivity, Ohm Metre	1.0x10 ¹²	1.0x10 ¹²	1.0x10 ¹²	ASTM D 257

HIGH PERFORMANCE

Sil-Pad 1000®, Sil-Pad 1500® and Sil-Pad 2000®

SIL-PAD 1000

Sil-Pad 1000 has the same excellent mechanical and physical characteristics of our Sil-Pad 400 material while offering a 35% reduction in thermal resistance.

Sil-Pad 1000 is a composite of silicone rubber and fiberglass. It is specially filled and offers low thermal resistance. Sil-Pad 1000 is non-toxic and resists damage from cleaning agents. It is flame retardant and specially formulated for use as a thermally conductive insulator.

SIL-PAD 1500

Sil-Pad 1500 is an economical, high performance insulator with a thickness between that of Sil-Pad 1000 and Sil-Pad 2000.

SIL-PAD 2000

Sil-Pad 2000 is Bergquist's high performance, high reliability thermally conductive insulator. Sil-Pad 2000 is designed for demanding military / aerospace and commercial applications. In these applications, Sil-Pad 2000 complies with military standards. This silicone elastomer is specially filled to maximize the thermal and dielectric performance of the filler / binder matrix. The result is a "grease-free", conformable material capable of meeting or exceeding the thermal and electrical requirements of high reliability electronic packaging applications. Sil-Pad 2000 is also available in thicknesses from .010" to .060".

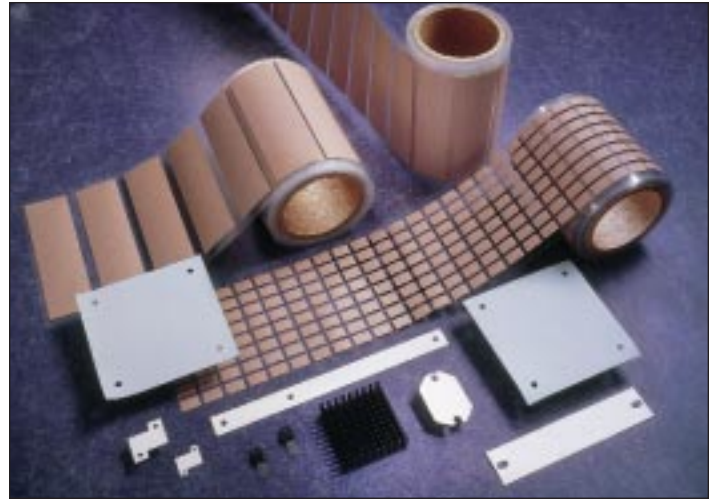

Die-Cut parts, Rolls and Sheets

Sil-Pad 1000, 1500 and 2000 are available in die-cut parts and sheets (6" x 6" min., 6" x 12", 8" x 8", 10" x 10" and 12" x 12"). Only Sil-Pad 1000 and 1500 are available in roll form.

SIL-PAD 2000 Outgassing Data for Spacecraft Materials

Post Cure Conditions	%TML (1.0% Max Acceptable)	%CVCM (0.1% Max Acceptable)
24 hrs. @ 175°C	.07	.03
No Post Cure	.26	.10

MIL SPEC.
MIL-M-38527/08
MIL-I-49456
MIL-I-49466/02
MIL-M-87111
U.L. FILE NUMBER
E59150
FSCM NUMBER 55285

Physical Properties	Sil-Pad 1000	Sil-Pad 1500	Sil-Pad 2000	Test Method
Color	Pink	Green	White	Visual
Thickness Inches (mm)	.009 ± .001" (.23 ± .025)	0.010 ± .001" (.25 ± .025)	.015 ± .002" (.38 ± .025)	ASTM D 374
Elongation, % 45° to warp and fill	45	20	20	ASTM D 412
Hardness, Shore A ± 5	85	80	90	ASTM D 2240
Breaking Strength Lbs/inch (kN/m)	100 (18)	65 (12)	65(12)	ASTM D 1458
Tensile Strength, kPsi (MPa)	4 (30)			ASTM D 412
Thermal Vacuum Weight Loss % (TML) as manufactured	.22		see	NASA SP-R-0022A
Volatile Condensable Material % (CVCM) as manufactured	.08		see	NASA SP-R-0022A
Specific Gravity	1.5	1.5	1.5	ASTM D 792
Continuous Use Temp., °C	-60 to +180	-60 to + 200	-60 to +200	--
Construction	Silicone/Fiberglass	Silicone/Fiberglass	Silicone/Fiberglass	

Thermal Properties	Sil-Pad 1000	Sil-Pad 1500	Sil-Pad 2000	Test Method
Thermal Resistance, °C/-in²/W	0.35	0.23	0.2	ASTM D 5470
Thermal Conductivity, W/m-K	1.2	2.0	3.5	ASTM D 5470

Electrical Properties	Sil-Pad 1000	Sil-Pad 1500	Sil-Pad 2000	Test Method
Breakdown Voltage, Volts a-c Min.	4500	4000	4000	ASTM D 149
Dielectric Constant, 1000 Cps (Hz)	4.5	4	4.0	ASTM D 150
Volume Resistivity, Ohm Metre	1.0x10 ¹¹	1.0 x 10 ¹¹	1.0x10 ¹¹	ASTM D 257

For Silicone Sensitive Applications

POLY-PADS...For Silicone Sensitive Applications

Polyester based, thermally conductive insulators from Bergquist provide a complete family of material for silicone-sensitive applications. Poly-Pads are ideally suited for applications requiring conformal coatings or applications where silicone contamination is a concern (telecommunications and certain aerospace applications). Poly-Pads are constructed with ceramic filled polyester resins coating either side of a fiberglass carrier or a film carrier. The Poly-Pad family offers a complete range of performance characteristics to match individual applications.

POLY-PAD 400®

Poly-Pad 400 is a fiberglass based insulator coated with an alumina-filled polyester resin. Poly-Pad 400 is economical and designed for most standard applications.

POLY-PAD 1000®

Poly-Pad 1000 is also a fiberglass based insulator coated with a boron nitride filled polyester resin. Poly-Pad 1000 offers superior thermal resistance for high performance applications.

POLY-PAD K-4®

Poly-Pad K-4 is a composite of film coated with a polyester resin. PPK-4 is an economical insulator and the film carrier provides excellent dielectric and physical strength.



POLY-PAD K-10®

Poly-Pad K-10 is a composite of film coated with a polyester resin. PPK-10 offers superior thermal performance for your most critical applications with thermal resistance of 0.2 °C-in²/Watt as well as excellent dielectric strength.

Die-Cut parts, Rolls and Sheets

Poly-Pads are available in die-cut parts, sheets (6" x 6" min., 6" x 12", 8" x 8", 10" x 10" and 12" x 12") and roll form.

Physical Properties	Poly-Pad 400	Poly-Pad 1000	Poly-Pad K-4	Poly-Pad K-10	Test Method
Color	Mauve	Yellow	Mauve	Yellow	Visual
Thickness Inches (mm)	.009 ± .001 (.23 ± .025)	.009 ± .001 (.23 ± .025)	.006 ± .001 (.15 ± .025)	.006 ± .001 (.15 ± .025)	ASTM D374
Elongation, % 45° to warp and fill	10	10	40	40	ASTM D412
Hardness, Shore A ± 5	90	90	90	90	ASTM D2240
Breaking Strength Lbs/inch (kN/m)	100 (18)	100 (18)	30 (5)	30 (5)	ASTM D1458
Tensile Strength, kPsi 45° to warp and fill (MPa)	7 (50)	7 (50)	5 (35)	5 (35)	ASTM D412
Specific Gravity	2.0	1.5	1.8	1.3	ASTM D792
Continuous Use Temperature, C	-20 to 150	-20 to 150	-20 to 150	-20 to 150	--
Construction	Polyester/Fiberglass	Polyester/Fiberglass	Polyester/Film	Polyester/Film	
Thermal Properties	Poly-Pad 400	Poly-Pad 1000	Poly-Pad K-4	Poly-Pad K-10	
Thermal Resistance, °C-in ² /W	0.4	0.3	0.3	0.2	ASTM D5470
Thermal Conductivity, W/m-K	0.9	1.2	.9	1.3	ASTM D5470
Electrical Properties	Poly-Pad 400	Poly-Pad 1000	Poly-Pad K-4	Poly-Pad K-10	
Breakdown Voltage, Volts a-c Min.	4500	2500	6000	6000	ASTM D149
Dielectric Constant, 1000 Cps (Hz)	5.5	4.5	5.0	3.7	ASTM D150
Volume Resistivity, Ohm Metre	1.0 x 10 ¹¹	1.0 x 10 ¹¹	1.0 x 10 ¹²	1.0 x 10 ¹²	ASTM D257

Q-PAD II[®], Q-PAD 3[®]

Grease Replacement Materials without Electrical Isolation

Q-Pad II[®] Eliminates Grease

Q-Pad II is a composite of .0015" aluminum foil coated both sides with .0025" thick thermally/electrically conductive Sil-Pad rubber. It is designed for those applications where maximum heat transfer is needed and electrical insulation is not required. Q-Pad II is the ideal thermal interface material to replace messy thermal grease compounds.

Q-Pad II eliminates problems associated with grease such as contamination of reflow solder or cleaning operations. Q-Pad II can be used prior to these operations unlike grease. Q-Pad II also eliminates dust collection which can cause possible surface shorting or heat buildup. Some applications where the material is typically used include:

- Between a transistor and a heat sink.
- Between two large surfaces such as an L-Bracket and the chassis of an assembly.
- Between a heat sink and a chassis.
- Under electrically isolated power modules or devices such as resistors, transformers and solid state relays.

Q-PAD 3[®]

The new Bergquist Q-Pad 3 eliminates problems associated with thermal grease such as contamination of electronic assemblies and reflow solder baths. Q-Pad 3 may be installed prior to soldering and cleaning, without worry. When

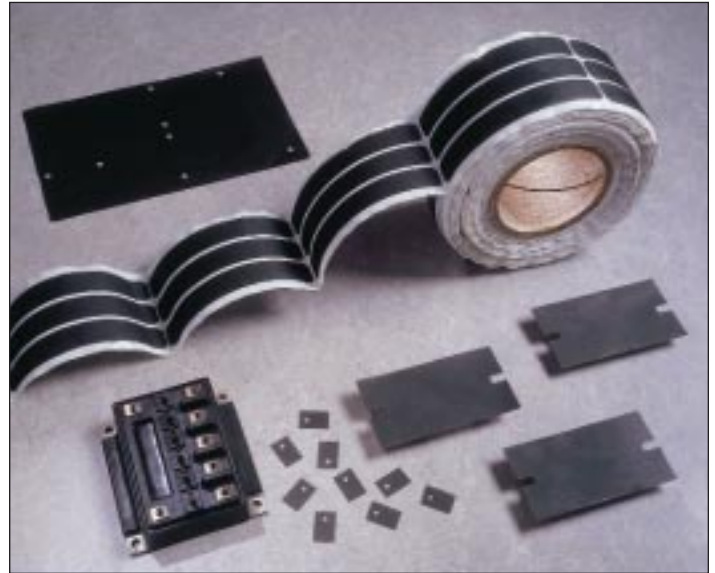

clamped between two surfaces, the elastomer conforms to surface textures thereby creating an air free interface between heat generating components and heat sinks.

Fiberglass reinforcement enables Q-Pad 3 to withstand processing stresses without losing physical integrity. Q-Pad II and 3 are both available with or without adhesive.

Die-Cut parts, Rolls and Sheets

Q-Pad II and Q-Pad 3 are available in die-cut parts and sheets (6" x 6" min., 6" x 12", 8" x 8", 10" x 10" and 12" x 12") and roll form.

Physical Properties	Q-PAD II	Q-PAD 3	Test Method
Color	Black	Black	Visual
Thickness Inches (mm)	.006/.0065 w/ac ±.001 .152 ±.025	.005/.0055 (w/ac) (.15)	ASTM D374 ASTM D374
Service Temperature °C	180 w/o ac 150 w/ac		--
Thermal Properties	Q-PAD II	Q-PAD 3	Test Method
Thermal Resistance, °C-in ² /W	0.10 w/o ac 0.20 w/ac	0.10 w/o ac 0.14 w/ac	
Metric (cm ² -K/w)	.65 w/o ac 1.3 w/ac	.65 w/o ac 0.9 w/ac	
Thermal Conductivity, W/m-K	2.5 w/o ac 1.3 w/ac	2.0 w/o ac 1.6 w/ac	ASTM D5470
Electrical Properties	Q-PAD II	Q-PAD 3	Test Method
Volume Resistivity, Ohm Metre	1.0 x 10 ² w/o ac 10 ³ w/ac	10 ⁻¹ w/o ac 10 ¹ w/ac	ASTM D4496

LOW PRESSURE

Sil-Pad 800-S® and Sil-Pad 900-S®

The Sil-Pad 800 and 900 family of thermally conductive insulation materials are designed for low cost applications requiring high thermal performance. These applications also typically have low mounting pressures for component clamping.

The Sil-Pad 800-S material combines a smooth surface design with high thermal conductivity and electrical insulation. These features optimize the thermal resistance properties at low pressure.

Applications requiring low component clamping forces include discrete semiconductors (TO-220, TO-247 and TO-218) mounted with spring clips. Spring clips provide quick assembly but apply a limited amount of pressure to the semiconductor. The smooth surface texture of Sil-Pad 800-S maximizes thermal performance.

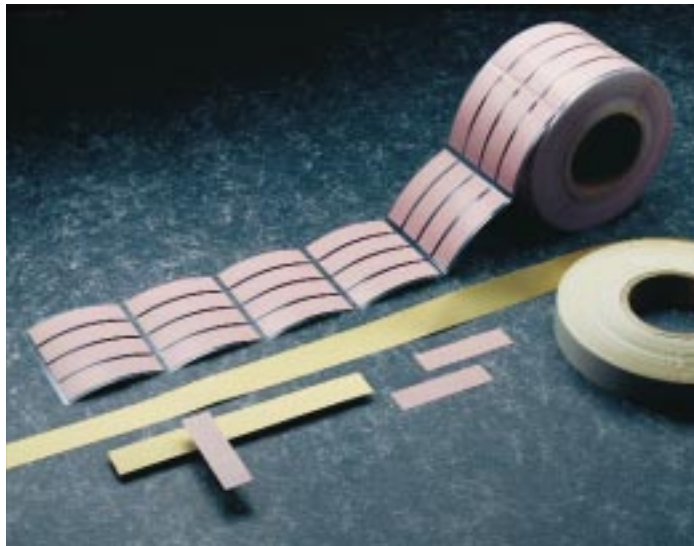

Die-Cut parts, Rolls and Sheets

Sil-Pad 800-S and Sil-Pad 900-S are available in die-cut parts, sheets (6" x 6" min., 6" x 12", 8" x 8", 10" x 10" and 12" x 12") and roll form.

Physical Properties	Sil-Pad 800-S	Sil-Pad 900-S	Test Method
Color	Gold	Mauve	Visual
Thickness Inches (mm)	.005 ± .001 (.13 ± .025)	.009 ± .001 (.23 ± .025)	ASTM D 374
Tensile Elongation 45° to warp and fill	20	20	ASTM D 412
Tensile Strength, MPa 45° to Warp & Fill, (kPsi)	12 (1.7)	9 (1.3)	ASTM D 412

Thermal Properties	Sil-Pad 800-S	Sil-Pad 900-S	Test Method
C-in ² /Watt	0.1	0.2	
Thermal Resistance, cm ² /Watt	0.85	1.5	ASTM D 5470
Thermal Conductivity, W/m-K	1.6	1.6	ASTM D 5470

Electrical Properties	Sil-Pad 800-S	Sil-Pad 900-S	Test Method
Breakdown Voltage			
Type 1 Electrodes, kVa-c	1.7	5.5	ASTM D 149
Type 3 Electrodes, kVa-c	3.0	8.3	ASTM D 149
Volume Resistivity, Ohm Metre	1.0x10 ¹⁰	1.0x10 ¹⁰	ASTM D 257
Dielectric Constant, 1kHz	6.0	6.0	ASTM D 150

SIL-PAD SHIELD®

Bonded Laminate of Sil-Pad with a Copper Shield

SIL-PAD SHIELD®

Bergquist Sil-Pad Shield is a bonded laminate of thermally conductive, electrically isolating Sil-Pad 400 or Sil-Pad 1000 pads with a copper shield between the layers. It is supplied with a pretinned solder point for easy grounding.

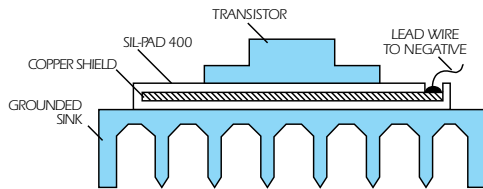

RFI Produced by Heat Sink Current

The capacitance between a TO-3 encapsulated transistor and its heat sink is typically 100 pf when a mica or other insulating washer is used. A power supply constructed with a standard insulator and a grounded heat sink can be expected to produce about 10 times more interference than is permitted.

A solution to the problem can be accomplished by:

1. The use of chokes, filters and LC networks which have to be designed into the circuitry.
- OR
2. Constructing a shield between the transistor and its heatsink by:

Replacing the mica insulator with a Sil-Pad Shield (Fig.1).

Table 6 Typical properties of Sil-Pad Shield

Thickness (total) inches	.019 ⁺⁰⁰⁴ / _{-.002} (.48mm)	--
Shield Thickness inches	.0015 (.04mm)	--
Copper Thickness		
Approx. Thermal Resistance (TO-3)	.85° to 1.0°C/W	--
Min. Breakdown Voltage Between Device & Copper	4500 Volts	ASTM D149
Capacitance at 1000 Hz and 5 Volts	50 pico F	
Dissipation Factor at 1000 Hz and 5 Volts (TO-3) Power Factor	.0155	ASTM D150
Dielectric Constant at 1000 Hz and 5 Volts	5.5	ASTM D 150
Continuous Use Temp. °C	-60 to +180	--
Recommended Torque (TO-3)	6-8 inch Lbs. (0.7-0.9 Nm)	--

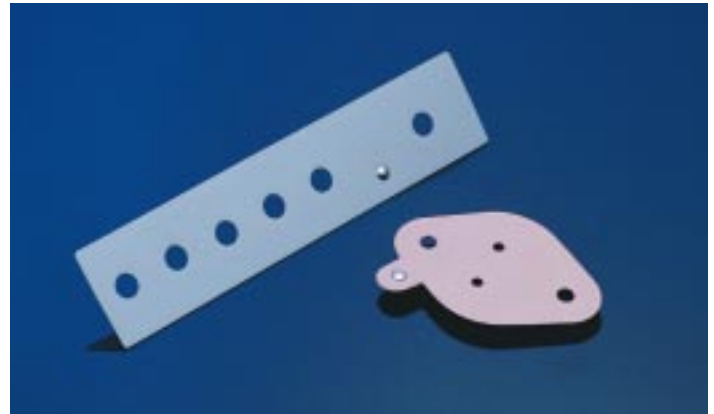

Sil-Pad Shield is a laminate of copper with Sil-Pad thermally conductive insulators. Sil-Pad Shield provides:

- Shielding effectiveness of 50dB or higher.
 - Electrical isolation of 500 volts minimum.
 - Good thermal transfer.
 - Reduced labor costs due to the elimination of having to apply thermal grease. See information on Sil-Pad 400.
- SPECIAL SHAPES: Sil-Pad Shield is available in any custom configuration to meet special requirements. Tooling charges are about \$300-\$500 for simple parts.

SIL-PAD SHIELD® CONFIGURATIONS

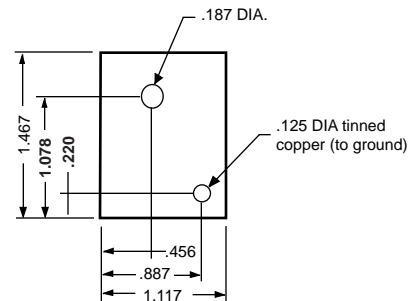

P/N 09SPS01-133 (TO-3P)
(continued on following page)

Sil-Pad Shield Standard Configurations

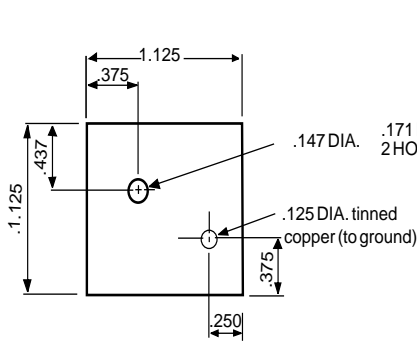

P/N 09SPS01-002 (TO-220)

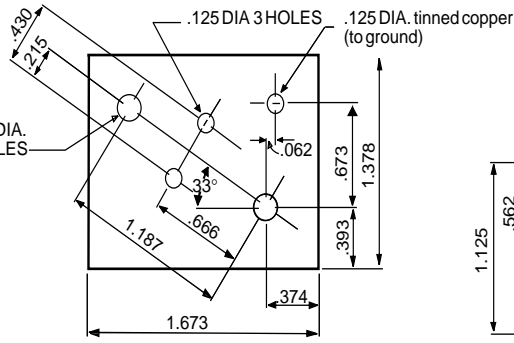

P/N 09SPS01-001 (TO-3)

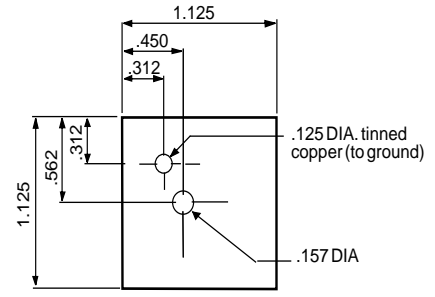

P/N 09SPS01-009

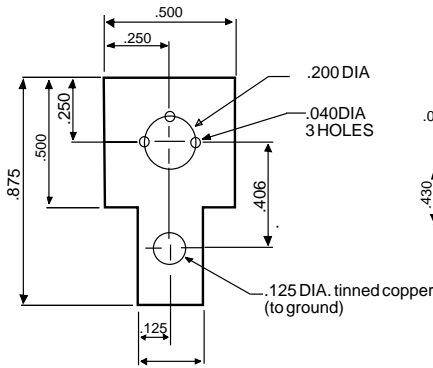

P/N 09SPS01-011 (TO-5)

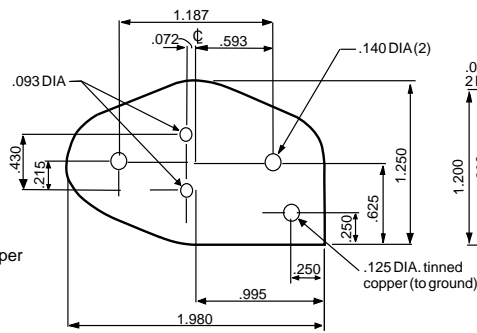

P/N 09SPS01-016 (TO-3)

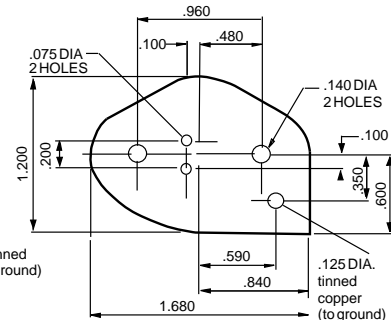

P/N 09SPS01-017 (TO-66)

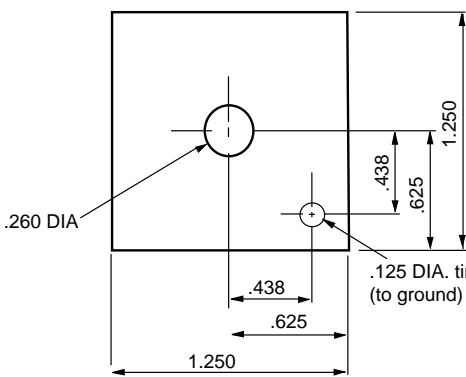

P/N 09SPS01-020 (DO-5)

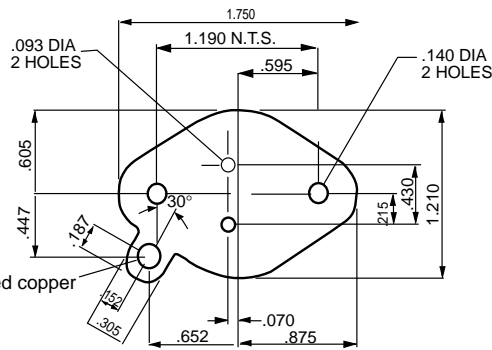

P/N 09SPS01-023 (TO-3)

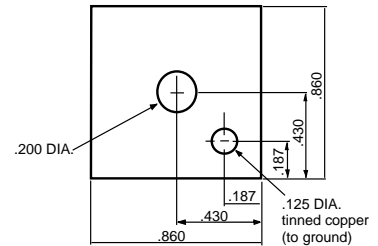

P/N 09SPS01-019 (DO-4)

Contact the factory for other configurations.

High Humidity Sil-Pad 1750® and Sil-Pad 1950®

SIL-PAD 1750®

The combination of high thermal conductivity and excellent dielectric strength retention after humidity exposure is formulated into the Sil-Pad 1750 elastomeric pad.

Sil-Pad 1750 relies on new processes that minimize the effect of high humidity on the electrical properties of finished material. Therefore, exposure to humid environments during assembly, or over long term operating conditions, will not severely affect the ability of the material to perform.

Sil-Pad 1750 may be purchased as sheets or punched parts. The material is available with either a Silicone or Acrylic adhesive. Sil-Pad 1750 is not available in rolls. Sheet sizes: (6" x 6", 6" x 12", 8" x 8", 10" x 10", 12" x 12")

SIL-PAD 1950®

The combination of high thermal conductivity and excellent dielectric strength retention after humidity exposure is formulated into the Sil-Pad 1950 elastomeric pad. The material transfers heat due to its high loading of special fillers and its ability to exclude air from large interfaces.

Sil-Pad 1950 relies on new processes that minimize the effect of high humidity on the electrical properties of finished material. Therefore, exposure to humid environments during assembly, or over long term operating conditions, will not severely affect the ability of the material to perform.

Sil-Pad 1950 may be purchased as sheets or punched parts. The material is available with either a Silicone or Acrylic adhesive. Sil-Pad 1950 is designed to be an economical material solution for high humidity, high dielectric requirements. Sil-Pad 1950 is not available in rolls. Sheet sizes: (6" x 6", 6" x 12", 8" x 8", 10" x 10", 12" x 12")

U.L. File Number E59150

Physical Properties	Sil-Pad 1750	Sil-Pad 1950	Test Method
Color	Green	Yellow	Visual
Thickness Inches (mm)	0.012 ± .001 (.30)	0.010 + .002 - .001 (.25)	ASTM D 374
Breaking Strength, Lbs/inch (kN/m)	65 (12)	65 (12)	ASTM D 1458
Hardness Shore A	85	85	ASTM D 2240
Thermal Properties	Sil-Pad 1750	Sil-Pad 1950	Test Method
Thermal Resistance, °C-in ² /W (m ² -°K/w)	0.20 (1.5 x 10 ⁻⁴)	0.23 (1.5 x 10 ⁻⁴)	ASTM D 5470
Thermal Conductivity, W/m-K	2.2	1.7	ASTM D 5470
Electrical Properties	Sil-Pad 1750	Sil-Pad 1950	Test Method
Breakdown Voltage VAC, min.	6000*	6000 4000*	ASTM D 149
Volume Resistivity, Ohm Metre			
As manufactured	1.0x10 ¹²	1.0x10 ¹²	ASTM D 257
After 48 Hours at 90% rh and 35°C	3 x10 ¹¹		
After 4 Hours at 150°C	2 x10 ¹⁴		

SPT 400 and SPT 1000

SPT 400 and SPT 1000 (“Sil-Pad Tubes”) provide thermally conductive insulation for clip mounted plastic power packages. Sil-Pad Tubes are made of silicone rubber with high thermal conductivity. Sil-Pad Tube 1000 is best suited for higher thermal performance and Sil-Pad Tube 400 is ideal for applications requiring average thermal performance and economy.

Sil-Pad Tube standard configurations are available for TO-220, TO-218, TO-247 and TO-3P plastic power packages. Special thicknesses and diameters can also be ordered. SPT 400 and SPT 1000 are designed to meet VDE, UL and TUV agency requirements. Typical properties of Sil-Pad Tube are shown in the table below.



	SPT 400	SPT 1000	Test Method
Color	Gray/Green	Brown	Visual
Thermal Resistance C-in ² /Watt	0.6	0.4	ASTM D5470
Thermal Conductivity, W/m-k	0.9	1.2	ASTM D5470
Breakdown Voltage, minimum	5000	5000	ASTM D149
Dielectric Constant, 1000 (Hz)	5.5	4.5	ASTM D150
Continuous Use Temp. °C	-60 to + 180	-60 to + 200	—
Hardness, Shore A	80	80	ASTM D2240
Thickness/Wall (Inches) (mm)	.012 (.30)	.012 (.30)	ASTM D374
Breaking Strength lbs./in. (kN/m)	6 (1)	6 (1)	ASTM D1458
Volume Resistivity, Ohm Meter	1.0 x 10 ¹¹	1.0 x 10 ¹¹	ASTM D257

Standard Dimensions

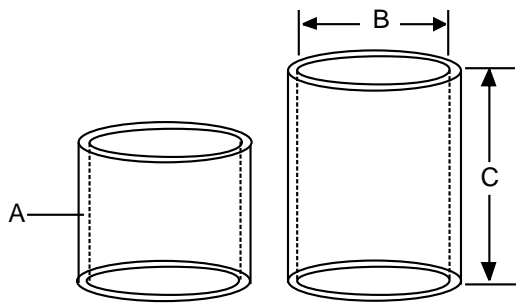

- A = Wall Thickness: .30 mm (.012") + .10 mm/-0.0 mm (+.004"/-0.0")
- B = Inner Diameter: 11 mm (.433") and 13.5 mm (.532") ±1.0 mm (±.039")
- C = Length: 25 mm (.985") and 30 mm (1.18") +3.18 mm/-0.0 mm (+.125"/-0.0")

Special lengths are available. For more information contact the factory.

Ordering Procedure:

Sample: SPT400
 "A" -"B" -"C"

Ordering Procedure, PSA Characteristics, Mil-Spec

Ordering Procedure

The last 2 or 3 digits define the part number selected. The “foot print” and dimensions are shown on previous pages. Each material has a prefix as shown on the next page.

Special Shapes: For applications requiring non standard or custom Sil-Pad configurations contact the factory.

We produce thousands of specials. Tooling charges are about \$150 to \$200 for simple parts. Increased complexity or tighter tolerances increase tooling charges.

Tolerances: .015 inches, (.4mm) are held on width, length, hole diameter and hole location. Contact the factory if tighter tolerances are required.

Sheets: 6" x 6", 6" x 12", 8" x 8", 10" x 10", or 12" x 12" sheets are available from stock, with or without adhesive.

When ordering sheets, state material, thickness and sheet size including dimensions.

Rolls: Sil-Pad materials are available in roll form, with or without adhesive. Contact the factory. Sil-Pad 2000 is not available in rolls. Sil-Pad 2000, maximum sheet size, 12" x 16".

Adhesive Characteristics: TYPE: Low tack dimethyl silicone, pressure sensitive (SP400, SP600 SP1000, SP1500). High tack pressure sensitive acrylic adhesive. (K-4, K-6, K-10, Q2, SP2000, Poly-Pad materials).

THICKNESS: .0005-.001,(12-25µm) (Adhesive only)

PEEL STRENGTH: Approx. 100 to 250 grams/inch width (5 to 10gm/mm). Adhesive coated Sil-Pads are provided on a release liner.

SHELF LIFE: One year for silicone adhesive, 18 months for acrylic adhesive.

TAC (thermal adhesive coating) six (6) months in warehouse below 90 degrees.

Mil-Spec Reference Guide

Bergquist will supply a Thermal Insulation Material Cross Reference Listing for all pertinent military part numbers included in the following Mil-Specs:

MIL M-38527 / 08
MIL I-49466 / 02
MIL H-87111
MIL I-49456A

Each Bergquist part number specifies a Bergquist grade of thermal insulation material and a transistor case configuration. Details of different Bergquist thermal insulation materials as well as details on different thermal insulator configurations are found on previous pages of the Sil-Pad Design Guide.

MIL-I-49456A specifies a fiberglass reinforced elastomeric sheet material showing type and class. MIL-I-49466-02, MIL M-38527 / 08 and MIL-H-87111 specify thermal insulator configurations.

MIL I-49466 / 02 supersedes the part numbers covered under MIL M-38527 / 08. M49466 / 02 is the most complete listing of military part numbers. Each of the military part numbers in M49466 / 02 is cross referenced to specific Bergquist part numbers. Please use MIL-I-49466 whenever possible. Please contact The Bergquist Company for the complete MIL Spec Reference Guide.

U.L. FILE NUMBER E59150 FSCM NUMBER 55285

PSA Characteristics

Standard pressure sensitive adhesive (AC) coated on one side of a Sil-Pad will increase the thermal resistance (per ASTM D5470) by 0.2 C/in²/W. Standard psa on 2 sides increases the thermal impedance by 0.4 C/in²/W.

Thermally conductive psa (TAC) on one side increases the thermal resistance by 0.05 C/in²/W and on two sides by 0.1 C/in²/W.

The effect of AC and TAC on the thermal impedance in an application will vary. In low pressure applications, the pressure sensitive adhesive will wet out the interface easier and eliminate the interfacial thermal resistance.

Bergquist recommends the use of dispensing equipment for certain adhesive coated parts. Please contact the factory for additional information.

Peel adhesion data is available from the factory. Contact The Bergquist Company.

Building a Part Number

MATERIAL THICKNESS:

SIL-PAD 400®

- .007" .009"
- .015" .030"
- .045"
- ADHESIVE 1 SIDE
- ADHESIVE 2 SIDES

SIL-PAD 600®

- .009"
- ADHESIVE 1 SIDE
- ADHESIVE 2 SIDES

SIL-PAD 1000®

- .009"
- .015"
- ADHESIVE 1 SIDE
- ADHESIVE 2 SIDES

SIL-PAD 1500®

- .010"
- ADHESIVE 1 SIDE
- ADHESIVE 2 SIDES

SIL-PAD 2000®

- .010" .015" .020" .030"
- .040" .050" .060" .080"
- ADHESIVE 1 SIDE
- ADHESIVE 2 SIDES

SIL-PAD SHIELD®

- SP400" SP1000"

SIL-PAD K-4®

- .006"
- ADHESIVE 1 SIDE
- ADHESIVE 2 SIDES

SIL-PAD K-6®

- .006"
- ADHESIVE 1 SIDE
- ADHESIVE 2 SIDES

SIL-PAD K-10®

- .006"
- ADHESIVE 1 SIDE
- ADHESIVE 2 SIDES

SIL-PAD 800-S®

- .005" DRY
- .005" ADHESIVE

SIL-PAD 900-S®

- .009" DRY
- .009" ADHESIVE

SIL-PAD 1750®

- .012" DRY
- .012" ADHESIVE

SIL-PAD 1950®

- .010" DRY
- .010" ADHESIVE

POLY-PAD 400®

- .009"
- ADHESIVE 1 SIDE
- ADHESIVE 2 SIDES

POLY-PAD 1000®

- .009"
- ADHESIVE 1 SIDE
- ADHESIVE 2 SIDES

POLY-PAD K-4®

- .006"
- ADHESIVE 1 SIDE
- ADHESIVE 2 SIDES

POLY-PAD K-10®

- .006"
- ADHESIVE 1 SIDE
- ADHESIVE 2 SIDES

Q-PAD II®

- .006"
- ADHESIVE 1 SIDE

Q-PAD 3®

- .005"
- ADHESIVE 1 SIDE

SOFTFACE™

(INSULATING) (NON-INSULATING)

- .003" .005"
- .005" .008"
- .008"

BOND PLY™

- .005"
- .008"
- .011"

HI FLOW™

- .005"
- Contact the factory for other thicknesses.

GAP PAD VO SOFT™

- .020" .100"
- .040" .125"
- .060" .160"
- .080"
- ADHESIVE 1 SIDE

GAPPAD VO™ & VO ULTRA SOFT™

- .020" .080" .160"
- .040" .100" .200"
- .060" .125" .250"
- ADHESIVE 1 SIDE

GAP PAD™ 1500

- .020" .100"
- .040" .125"
- .060" .160"
- .080" .200"

GAP PAD™ 1500R

- .010" .020"
- .015" .030"

GAP PAD™ 2000 & 3000

- .010" .060"
- .015" .080"
- .020" .100"
- .040" .125"

BUILDING A PART NUMBER

Insert standard configuration,
2 or 3 digit part number suffix.

SP400 - 7 mil - dry 3223-07FR-____
SP400 - 9 mil - dry 7403-09FR-____

SP400 - 7 mil - adhesive 3223-07AC-____
SP400 - 9 mil - adhesive 7403-09AC-____

SP1000 - 9 mil - dry 1009-____
SP1000 - 9 mil - adhesive 1009AC-____

SP600 - 9 mil - dry SP600-____
SP600 - 9 mil - adhesive SP600AC-____

SP1500 - 10 mil - dry 1510-____
SP1500 - 10 mil - adhesive 1510AC-____

SP2000 - 15 mil - dry 2015-____
SP2000 - 15 mil - adhesive 2015AC-____

K4 - 6 mil - dry K4-____
K4 - 6 mil - adhesive K4AC-____

K6 - 6 mil - dry K6-____
K6 - 6 mil - adhesive K6AC-____

K10 - 6 mil - dry K10-____
K10 - 6 mil - adhesive K10AC-____

Q2 - 6 mil - dry Q2-____
Q2 - 6 mil - adhesive Q2AC-____

Q3 - 5 mil - dry Q3-____
Q3 - 5 mil - adhesive Q3AC-____

PP400 - 9 mil - dry PP400-____
PP400 - 9 mil - adhesive PP400AC-____

PP1000 - 9 mil - dry PP1000-____
PP1000 - 9 mil - adhesive PP1000AC-____

PPK10 - 6 mil - dry PPK10-____
PPK10 - 6 mil - adhesive PPK10AC-____

SIL-PAD SHIELD 400 09SPS01-____
SIL-PAD SHIELD 1000 01SPS01-____

SIL-PAD 800-S - 5 mil - dry SP800S-____
SIL-PAD 800-S - 5 mil - adhesive SP800SAC-____

SIL-PAD 900-S - 9 mil - dry SP900S-____
SIL-PAD 900-S - 9 mil - adhesive SP900SAC-____

SP1750 - 12 mil - dry 1750-____
SP1750 - 12 mil - adhesive 1750AC-____

SP1950 - 10 mil - dry 1950-____
SP1950 - 10 mil - adhesive 1950AC-____

Sil-Pad® Standard Configurations

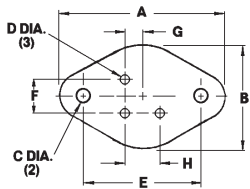

4 Lead TO-66	Part Number Suffix	"A"	"B"	"C"	"D"	"E"	"F"	"G"
	-84	1.312	.762	.140	.062	.960	.200	.100

	Plastic Power	Part Number Suffix	Dimensions				Part Number Suffix	Dimensions			
			"A"	"B"	"C"	"D"		"A"	"B"	"C"	"D"
TO-220	Various (Clip Mount)	-35	.710	.500	.160	.141	Various	1.000	.750	.300	.140
	TO-126	-43	.750	.500			Various	.810	.910	.170	.147
	TO-126	-50	.437	.312	.140	.093	Various	.984	.787		
	Various	-51	.687	.562	.218	.125	Various	.827	.945	.197	.150
	Various	-52	.855	.630	.230	.093	Various	.855	.630	.228	.122
	TO-220	-54	.750	.500	.187	.147	Various	.827	.709	.256	.126
	TO-202	-55	.610	.560	.245	.125	Various	.748	.551	.217	.126
	Various	-56	.855	.562	.218	.125	Various	.437	.311	.142	.110
	TO-220	-58	.750	.500	.187	.125	Various	.728	.472	.157	.098
	TO-126	-60	.437	.312	.140	.122	TO-3P	1.140	.810	.355	.147
	Various	-61	.750	.410	.225	.156	Various	.945	.748	.256	.162
	TO-220	-62	.750	.600	.240	.150	Various	.984	1.654	.315	.157
	Various	-63	.750	.600	.240	.115	Various	.709	.512	.177	.122
	Various	-64	.500	.385	.170	.120	Various	.472	.315	.157	.126
	TO-218	-68	1.125	.625	.200	.145	Various	.866	.709	.256	.126
	Various	-70	1.410	.810	.355	.147	Various	.945	.709	.228	.126
	Various	-90	.860	.740	.200	.160	Various	1.250	1.000		
Various	-102	.866	.650	.217	.142	Various	1.250	1.000	.258	.127	
Various	-103	.750	.800	.150	.160	Various	1.250	1.000	.258	.148	

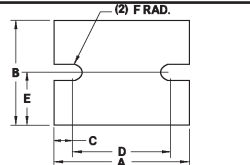
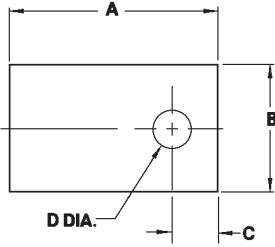

Power Module	Part Number Suffix	"A"	"B"	"C"	"D"	"E"	"F"
	-67	1.500	.900	.150	1.200	.450	.075
	-101	2.500	2.000	.344	1.812	1.000	.156

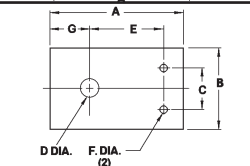

Plastic Power	Part Number Suffix	"A"	"B"	"C"	"D"	"E"	"F"	"G"
	-57	.910	.500	.200	.125	.580	.046	.265
	-89	.983	.750	.432	.156	.665	.101	.217

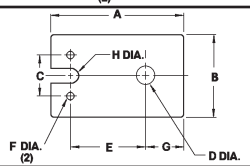

Plastic Power	Part Number Suffix	"A"	"B"	"C"	"D"	"E"	"F"	"G"	"H"
	-66	1.000	.500	.200	.141	.626	.046	.219	.032

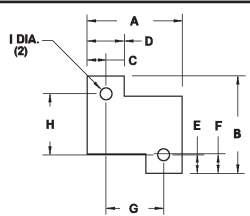

Power Resistor	Part Number Suffix	"A"	"B"	"C"	"D"	"E"	"F"	"G"	"H"	"I"
RH-25	-94	1.187	1.205	.234	.469	.212	.156	.719	.781	.140
RH-50	-95	2.093	1.265	.265	.530	.210	.255	1.563	.845	.140
RH-5	-96	.725	.771	.140	.280	.140	.156	.445	.491	.093
RH-10	-97	.805	.890	.127	.250	.130	.190	.551	.630	.121
RH-25	-98	1.150	1.180	.231	.425	.190	.270	.688	.800	.147
RH-50	-99	1.965	1.236	.198	.404	.132	.263	1.569	.972	.130

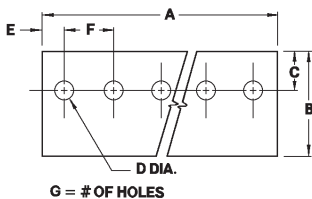

TO-220 Multiples	Part Number Suffix	"A"	"B"	"C"	"D"	"E"	"F"	# Of Holes
2 Parts	-34	1.000	.750	.187	.125	.250	.500	2
3 Parts	-36	1.500	.750	.187	.125	.250	.500	3
	-37	2.000	.750	.187	.125	.250	.500	4
	-38	2.500	.750	.187	.125	.250	.500	5
	-39	3.000	.750	.187	.125	.250	.500	6
	-40	3.500	.750	.187	.125	.250	.500	7
	-41	4.000	.750	.187	.125	.250	.500	8

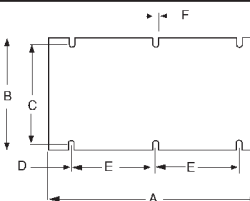

Power Module	Part Number Suffix	"A"	"B"	"C"	"D"	"E"	"F"
	-108	4.600	2.400	2.125	.500	1.800	.125

Sil-Pad® Standard Configurations

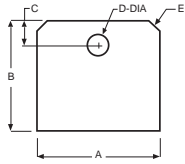

Multiwatt	Part Number Suffix	"A"	"B"	"C"	"D"	"E"
	-124	.872	.790	.160	.148	.118 x 45°
	-125	.866	.787	.157	.154	.079 x 45°

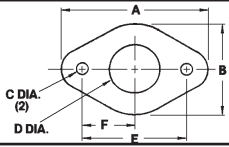

Multi-Lead TO-66	Part Number Suffix	"A"	"B"	"C"	"D"	"E"	"F"
	-93	1.350	.800	.140	.400	.960	.480

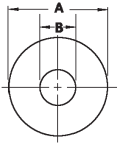

Diode Washer	Part Number Suffix	Dimensions "A" "B"		Part Number Suffix	Dimensions "A" "B"	
Various	-19	.510	.140	Various	-75	.360 .260
DO-4	-20	.510	.200	Various	-76	.750 .125
DO-5	-21	.800	.260	Various	-77	.800 .190
DO-4 (oversized)	-22	.625	.200	DO-8	-78	.875 .313
DO-5 (oversized)	-25	1.000	.260	Various	-79	1.180 .515
Various	-26	.812	.145	Various	-80	1.250 .380
Various	-27	.812	.115	Various	-81	1.500 .200
Various	-28	1.000	.140	Various	-82	.512 .161
Various	-32	1.500	.500	Various	-111	.591 .217

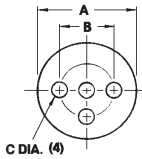

TO-36	Part Number Suffix	"A"	Dimensions "B" "C"	
	-08	1.063	.690	.190

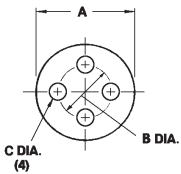

Small Power Devices	Part Number Suffix	"A"	"B"	"C"
TO-5, 3 Holes	-09	.360	.200	.040
TO-18, 3 Holes	-12	.250	.100	.036
TO-18, 4 Holes	-13	.250	.100	.036
TO-5, 4 Holes	-33	.360	.200	.040
TO-5, 3 Holes	-44	.390	.200	.040
TO-5, 4 Holes	-45	.390	.200	.040

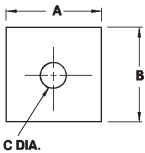

Rectifier	Part Number Suffix	"A"	Dimensions "B" "C"	
	-46	1.250	1.250	.200
	-47	1.125	1.125	.140
	-48	1.000	1.000	.187

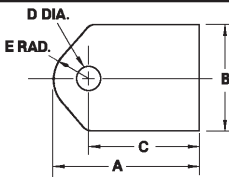

TIP Packages	Part Number Suffix	"A"	"B"	"C"	"D"	"E"
Clip Mount	-42	.984	.787			.205
TIP-36 Plastic Tip	-53	.865	.650	.650	.140	.205
TO-3P	-65	1.260	.787	.984	.142	.205
Plastic Clip	-73	.984	.787	.708	.142	.205

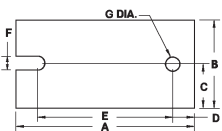

Power Module	Part Number Suffix	"A"	"B"	Dimensions "C" "D"		"E"	"F"	"G"
	-100	2.510	1.260	.630	.305	1.900	.205	.205
	-123	1.614	1.102	.551	.157	1.220	.118	.118

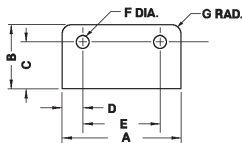

SIP Package	Part Number Suffix	"A"	"B"	"C"	"D"	"E"	"F"	"G"
	-105	1.450	.838	.612	.245	.960	.170	.120

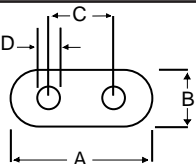

Quartz	Part Number Suffix	"A"	"B"	"C"	"D"
	-115	.472	.197	.193	.031

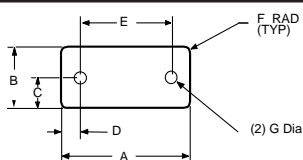

Power Module	Part Number Suffix	"A"	"B"	"C"	"D"	"E"	"F"	"G"
	-109	1.350	.642	.321	.195	.960	.060	.125

Sil-Pad® Standard Configurations

TO-3 & TO-66 Style	Part Number Suffix	Dimensions						
		"A"	"B"	"C"	"D"	"E"	"F"	"G"
	-02	1.780	1.250	.140	.093	1.187	.430	.072
	-03	1.563	1.050	.140	.080	1.187	.430	.072
	-04	1.650	1.140	.122	.062	1.187	.430	.072
	-05	1.650	1.140	.140	.093	1.187	.430	.072
	-06	1.650	1.140	.165	.062	1.187	.430	.072
	-07	1.780	1.250	.165	.094	1.187	.430	.072
	-10	1.440	1.000	.140	.075	.960	.200	.100
	-11	1.312	.762	.140	.062	.960	.200	.100
	-15	1.780	1.250	.140	.046	1.187	.430	.072
	-16	2.070	1.560	.122	.062	1.187	.430	.072
	-17	1.650	1.140	.140	.046	1.187	.430	.072
	-18	1.563	1.050	.140	.140	1.187	.430	.072
	-23	1.593	1.100	.156	.062	1.187	.430	.072
	-24	1.700	1.187	.156	.062	1.187	.430	.072
	-29	1.650	1.065	.140	.046	1.187	.430	.072
	-30	1.250	.700	.140	.062	.960	.200	.100
	-31	1.375	.825	.140	.062	.960	.200	.100
	-59 Leadless	1.650	1.140	.165		1.187		
	-112	1.780	1.248	.165	.063	1.185	.429	.073
	-113	1.563	1.051	.165	.079	1.185	.429	.073
	-127	1.307	.819	.165	.063	.909	.236	.061
	-129	1.654	1.063	.138	.059	1.181	.433	.071
	-135	1.650	1.142	.165	.142	1.187	.429	.072

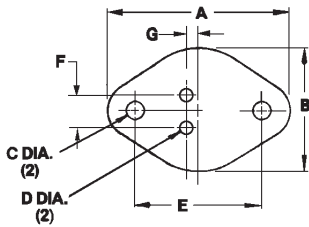

3 Lead TO-3	Part Number Suffix	Dimensions								
		"A"	"B"	"C"	"D"	"E"	"F"	"G"	"H"	"I"
	-92	1.650	1.140	.140	.093	1.187	.430	.400	.155	.718

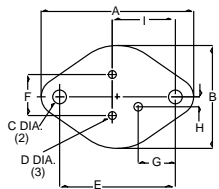

4 Lead TO-3	Part Number Suffix	Dimensions							
		"A"	"B"	"C"	"D"	"E"	"F"	"G"	Angle
	-86	1.560	1.050	.156	.080	1.170	.470	72°	
	-87	1.563	1.050	.156	.063	1.187	.470	72°	

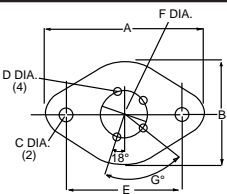

8 Lead TO-3	Part Number Suffix	Dimensions							
		"A"	"B"	"C"	"D"	"E"	"F"	"G"	Angle
	-88	1.655	1.187	.156	.060	1.187	.400	40°	.500

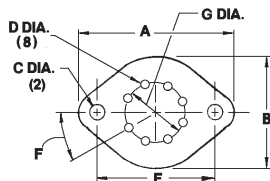

10 Lead TO-3	Part Number Suffix	Dimensions								
		"A"	"B"	"C"	"D"	"E"	"F"	"G"	"H"	Angle
	-91	1.650	1.140	.165	.040	1.187	.593	.500	32.7°	

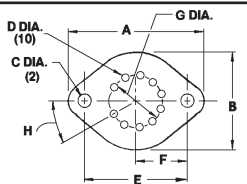

3 Lead TO-66	Part Number Suffix	Dimensions							
		"A"	"B"	"C"	"D"	"E"	"F"	"G"	"H"
	-85	1.275	.750	.156	.100	.960	.200	.100	.200

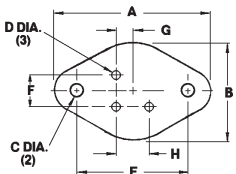

9 Lead TO-66	Part Number Suffix	Dimensions							
		"A"	"B"	"C"	"D"	"E"	"F"	"G"	"H"
	-83	1.440	1.000	.140	.055	.960	.480	.325	36°

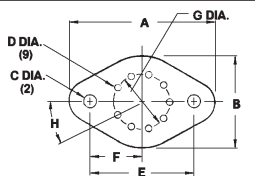

Power Module	Part Number Suffix	Dimensions				
		"A"	"B"	"C"	"D"	"E"
	-130	1.600	.480	.165	1.197	.240

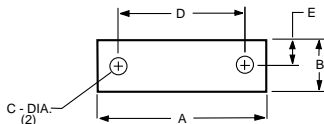

Sil-Pad® Standard Configurations SI Measurements

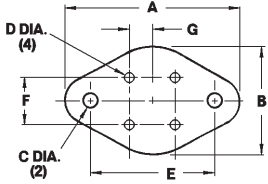

4 Lead TO-66	Part Number Suffix	"A"	"B"	"C"	"D"	"E"	"F"	"G"
	-84	33.32	19.35	3.56	1.57	24.38	5.08	2.54

Plastic Power	Part Number Suffix	Dimensions				Part Number Suffix	Dimensions					
		"A"	"B"	"C"	"D"		"A"	"B"	"C"	"D"		
TO-220	Various (Clip Mount)	-35	18.03	12.70	4.06	3.58	Various	-104	25.40	19.05	7.62	3.56
	TO-126	-43	19.05	12.70			Various	-107	20.57	23.11	4.32	3.73
	Various	-50	11.10	7.92	3.56	2.36	Various	-110	24.99	19.99		
	Various	-51	17.45	14.27	5.54	3.18	Various	-114	21.01	24.00	5.00	3.81
	Various	-52	21.72	16.00	5.84	2.36	Various	-116	21.72	16.00	5.79	3.10
	TO-220	-54	19.05	12.70	4.75	3.73	Various	-117	21.01	18.01	6.50	3.20
	TO-202	-55	15.49	14.22	6.22	3.18	Various	-118	19.00	14.00	5.51	3.20
	Various	-56	21.72	14.27	5.54	3.18	Various	-119	11.10	7.90	3.61	2.79
	TO-220	-58	19.05	12.70	4.75	3.18	Various	-120	18.49	11.99	3.99	2.49
	TO-126	-60	11.10	7.92	3.56	3.10	TO-3P	-122	28.96	20.57	9.02	3.73
	Various	-61	19.05	10.41	5.72	3.96	Various	-126	24.00	19.00	6.50	4.11
	TO-220	-62	19.05	15.24	6.10	3.81	Various	-128	24.99	42.01	8.00	3.99
	Various	-63	19.05	15.24	6.10	2.92	Various	-131	18.01	13.00	4.50	3.10
	Various	-64	12.70	9.78	4.32	3.05	Various	-132	11.99	8.00	3.99	3.20
	TO-218	-68	28.58	15.88	5.08	3.68	Various	-133	22.00	18.01	6.50	3.20
Various	-70	35.81	20.57	9.02	3.73	Various	-134	24.00	18.01	5.79	3.20	
Various	-90	21.84	18.80	5.08	4.06	Various	-136	31.75	25.40			
Various	-102	22.00	16.51	5.51	3.61	Various	-137	31.75	25.40	6.55	3.23	
Various	-103	19.05	20.32	3.81	4.06	Various	-138	31.75	25.40	6.55	3.76	

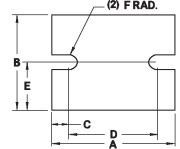
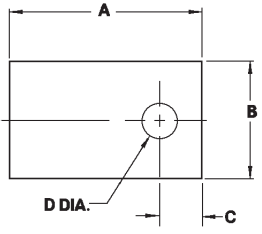

Power Module	Number Suffix	"A"	"B"	"C"	"D"	"E"	"F"
	-67	38.10	22.86	3.81	30.48	11.43	1.90
	-101	63.50	50.80	8.74	46.02	25.40	3.96

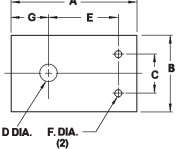

Plastic Power	Part Number Suffix	"A"	"B"	"C"	"D"	"E"	"F"	"G"
	-57	23.11	12.70	5.08	3.18	14.73	1.17	6.73
	-89	24.97	19.05	10.97	3.96	16.89	2.57	5.51

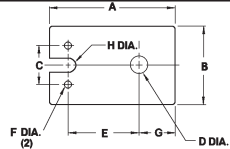

Plastic Power	Part Number Suffix	"A"	"B"	"C"	"D"	"E"	"F"	"G"	"H"
	-66	25.40	12.70	5.08	3.58	15.90	1.17	5.56	0.81

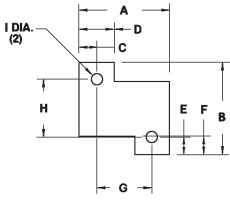

Power Resistors	Part Number Suffix	"A"	"B"	"C"	"D"	"E"	"F"	"G"	"H"	"I"
RH-25	-94	30.15	30.61	5.94	11.91	5.38	3.96	18.26	19.84	3.56
RH-50	-95	53.16	32.13	6.73	13.46	5.33	6.48	39.70	21.46	3.56
RH-5	-96	18.42	19.58	3.56	7.11	3.56	3.96	11.30	12.47	2.36
RH-10	-97	20.45	22.61	3.23	6.35	3.30	4.83	14.00	16.00	3.07
RH-25	-98	29.21	29.97	5.87	10.80	4.83	6.86	17.48	20.32	3.73
RH-50	-99	49.91	31.39	5.03	10.26	3.35	6.68	39.85	24.69	3.30

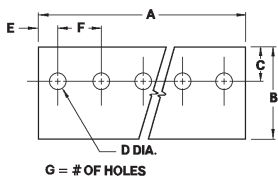

TO-220 Multiples	Part Number Suffix	"A"	"B"	"C"	"D"	"E"	"F"	# Of Holes
2 Parts	-34	25.40	19.05	4.75	3.18	6.35	12.70	2
3 Parts	-36	38.10	19.05	4.75	3.18	6.35	12.70	3
	-37	50.80	19.05	4.75	3.18	6.35	12.70	4
	-38	63.50	19.05	4.75	3.18	6.35	12.70	5
	-39	76.20	19.05	4.75	3.18	6.35	12.70	6
	-40	88.90	19.05	4.75	3.18	6.35	12.70	7
	-41	101.60	19.05	4.75	3.18	6.35	12.70	8

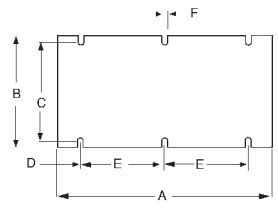

Power Module	Part Number Suffix	"A"	"B"	"C"	"D"	"E"	"F"
	-108	116.84	60.96	53.97	12.70	45.72	3.18

Sil-Pad® Standard Configurations SI Measurements

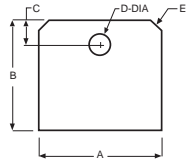

Multiwatt	Part Number Suffix	"A"	"B"	"C"	"D"	"E"
	-124	22.15	20.07	4.06	3.76	3.0 x 45°
	-125	22.00	19.99	3.99	3.91	2.0 x 45°

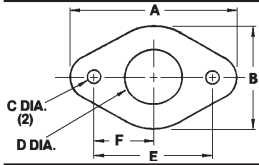

Multi-Lead TO-66	Part Number Suffix	"A"	"B"	"C"	"D"	"E"	"F"
	-93	34.29	20.32	3.56	10.16	24.38	12.19

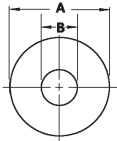

Diode Washer	Part Number Suffix	Dimensions "A"	Dimensions "B"	Part Number Suffix	Dimensions "A"	Dimensions "B"	
Various	-19	12.95	3.56	Various	-75	9.14	6.60
DO-4	-20	12.95	5.08	Various	-76	19.05	3.18
DO-5	-21	20.32	6.60	Various	-77	20.32	4.83
DO-4 (oversized)	-22	15.88	5.08	DO-8	-78	22.23	7.95
DO-5 (oversized)	-25	25.40	6.60	Various	-79	29.97	13.08
Various	-26	20.62	3.68	Various	-80	31.75	9.65
Various	-27	20.62	2.92	Various	-81	38.10	5.08
Various	-28	25.40	3.56	Various	-82	13.00	4.09
Various	-32	38.10	12.70	Various	-111	15.01	5.51

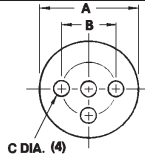

TO-36	Part Number Suffix	Dimensions "A"	Dimensions "B"	Dimensions "C"
	-08	27.00	17.53	4.83

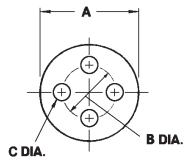

Small Power Devices	Part Number Suffix	"A"	"B"	"C"
TO-5, 3 Holes	-09	9.14	5.08	1.02
TO-18, 3 Holes	-12	6.35	2.54	0.91
TO-18, 4 Holes	-13	6.35	2.54	0.91
TO-5, 4 Holes	-33	9.14	5.08	1.02
TO-5, 3 Holes	-44	9.91	5.08	1.02
TO-5, 4 Holes	-45	9.91	5.08	1.02

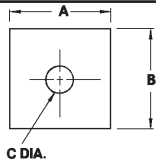

Rectifier	Part Number Suffix	"A"	Dimensions "B"	Dimensions "C"
	-46	31.75	31.75	5.08
	-47	28.58	28.58	3.56
	-48	25.40	25.40	4.75

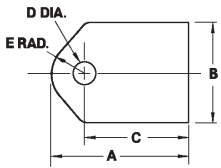

TIP Packages	Part Number Suffix	"A"	"B"	"C"	"D"	"E"
Clip Mount	-42	24.99	19.99			5.21
TIP-36 Plastic Tip	-53	21.97	16.51	16.51	3.56	5.21
TO-3P	-65	32.00	19.99	24.99	3.61	5.21
Plastic Clip	-73	24.99	19.99	17.98	3.61	5.21

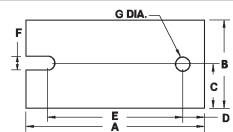

Power Module	Part Number Suffix	"A"	"B"	Dimensions "C"	Dimensions "D"	"E"	"F"	"G"
	-100	63.75	32.00	16.00	7.75	48.26	5.21	5.21
	-123	41.00	27.99	14.00	3.99	30.99	3.00	3.00

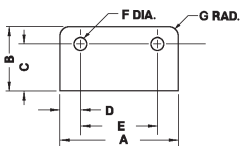

SIP Package	Part Number Suffix	"A"	"B"	"C"	"D"	"E"	"F"	"G"
	-105	36.83	21.29	15.54	6.22	24.38	4.32	3.05

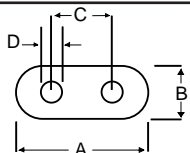

Power Module	Part Number Suffix	"A"	"B"	"C"	"D"
	-115	11.99	5.00	4.90	0.79

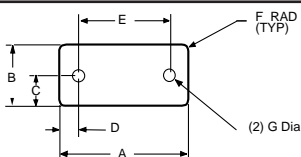

Power Module	Part Number Suffix	"A"	"B"	"C"	"D"	"E"	"F"	"G"
	-109	34.29	16.31	8.15	4.95	24.38	1.52	3.18

Sil-Pad® Standard Configurations SI Measurements

TO-3 Style	Part Number Suffix	Dimensions						
		"A"	"B"	"C"	"D"	"E"	"F"	"G"
	-02	45.21	31.75	3.56	2.36	30.15	10.92	1.83
	-03	39.70	26.67	3.56	2.03	30.15	10.92	1.83
	-04	41.91	28.96	3.10	1.57	30.15	10.92	1.83
	-05	41.91	28.96	3.56	2.36	30.15	10.92	1.83
	-06	41.91	28.96	4.19	1.57	30.15	10.92	1.83
	-07	45.21	31.75	4.19	2.39	30.15	10.92	1.83
	-10	36.58	25.40	3.56	1.90	24.38	5.08	2.54
	-11	33.32	19.35	3.56	1.57	24.38	5.08	2.54
	-15	45.21	31.75	3.56	1.17	30.15	10.92	1.83
	-16	52.58	39.62	3.10	1.57	30.15	10.92	1.83
	-17	41.91	28.96	3.56	1.17	30.15	10.92	1.83
	-18	39.70	26.67	3.56	3.56	30.15	10.92	1.83
	-23	40.46	27.94	3.96	1.57	30.15	10.92	1.83
	-24	43.18	30.15	3.96	1.57	30.15	10.92	1.83
	-29	41.91	27.05	3.56	1.17	30.15	10.92	1.83
	-30	31.75	17.78	3.56	1.57	24.38	5.08	2.54
	-31	34.92	20.96	3.56	1.57	24.38	5.08	2.54
	-59 Leadless	41.91	28.96	4.19		30.15		
	-112	45.21	31.70	4.19	1.60	30.10	10.90	1.85
	-113	39.70	26.70	4.19	2.01	30.10	10.90	1.85
	-127	33.20	20.80	4.19	1.60	23.09	5.99	1.55
	-129	42.01	27.00	3.51	1.50	30.00	11.00	1.80
	-135	41.91	29.01	4.19	3.61	30.15	10.90	1.83

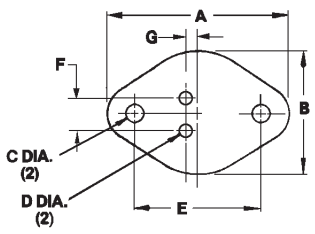

3 Lead TO-3	Part Number Suffix	Dimensions								
		"A"	"B"	"C"	"D"	"E"	"F"	"G"	"H"	"I"
	-92	41.91	28.96	3.56	2.36	30.15	10.92	10.16	3.94	18.24

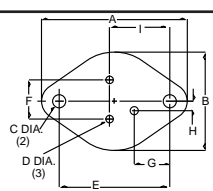

4 Lead TO-3	Part Number Suffix	Dimensions						
		"A"	"B"	"C"	"D"	"E"	"F"	"G"
	-86	39.62	26.67	3.96	2.03	29.72	11.94	72°
	-87	39.70	26.67	3.96	1.60	30.15	11.94	72°

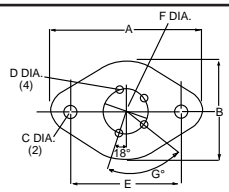

8 Lead TO-3	Part Number Suffix	Dimensions						
		"A"	"B"	"C"	"D"	"E"	"F"	"G"
	-88	42.04	30.15	3.96	1.52	30.15	40°	12.70

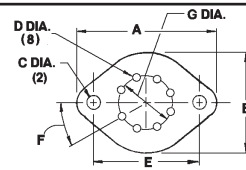

10 Lead TO-3	Part Number Suffix	Dimensions							
		"A"	"B"	"C"	"D"	"E"	"F"	"G"	"H"
	-91	41.91	28.96	4.19	1.02	30.15	15.06	12.70	32.7°

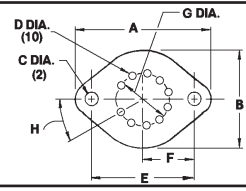

3 Lead TO-66	Part Number Suffix	Dimensions							
		"A"	"B"	"C"	"D"	"E"	"F"	"G"	"H"
	-85	32.38	19.05	3.96	2.54	24.38	5.08	2.54	5.08

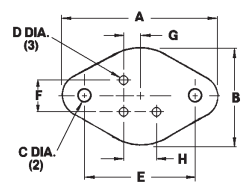

9 Lead TO-66	Part Number Suffix	Dimensions							
		"A"	"B"	"C"	"D"	"E"	"F"	"G"	"H"
	-83	36.58	25.40	3.56	1.40	24.38	12.19	8.26	36°

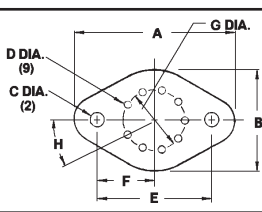

Power Module	Part Number Suffix	Dimensions				
		"A"	"B"	"C"	"D"	"E"
	-130	40.64	12.19	4.19	30.40	6.10

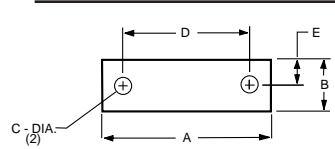

Thermal Products Group

THE BERGQUIST COMPANY

Click here to request more information For info

Standard Products:

The Bergquist Company established the standard for elastomeric thermally conductive insulation material with the development of Sil-Pads® over 20 years ago.

Grease Replacement Products
Grease Replacement Products To Support Precision and Performance Applications

Bergquist CPU Pad™ is a thermally conductive, electrically insulating, double coated tape typically used to mount a heat sink on top of a central processing unit on the circuit board.

POLY-PAD®, a polyester based, thermally conductive insulator from Bergquist provides a complete family of material for silicone-sensitive applications.

Bergquist Thermal Clad® is an Insulated Metal Substrate, copper clad material that may be used as a single sided replacement for ceramic substrate or printed wiring board material.

New Products/Information

For access to 38 technical papers on Sil-Pad Products go to the "Technical Corner" in the Bergquist website. Here's a sample of the technical papers available from The Bergquist Company:

- **What is Thermal Management at Bergquist** by Staff
Topic: Insulation
Published by Bergquist
- **Comparison of Semiconductor Isolation Materials** by Hanson
Topic: Insulation; Compares Sil-Pad type materials
Published by PCIM
- **Thermal Testing Procedures** by Hanson
Topic: TSP
Published by Bergquist
- **Two Layer Thermal Clad™, Thermal Clad Bond Ply™, and Low Modulus Bond Ply™**
by Fick
Topic: T-Clad, Two Layer
Published by Bergquist



THERMAL PRODUCTS GROUP

The Thermal Products Group is the largest division and the world leader in the development and manufacture of thermal management products.

- Sil-Pad thermally conductive insulators are the industry standard.
- More than 30 different materials designed to transfer heat.
- The engineers choice for combating heat in electronic assemblies.
- Bergquist R&D develops new materials and technologies.

BERGQUIST SWITCH

Bergquist Switch designs and manufactures membrane switches for harsh environments using their HeatSeal technology.

Custom built for OEM applications in these industries:

- medical instrumentation
- exercise equipment
- construction equipment
- applications with harsh chemical environments

*The Bergquist Company is
on the World Wide Web!*

Visit us at

<http://www.bergquistcompany.com>

DOMESTIC AGENTS

For a complete list of Bergquist sales representatives in the U.S. contact The Bergquist Company: 1-800-347-4572.

INTERNATIONAL AGENTS

For a complete list of European Bergquist sales representatives contact the European sales offices.

EUROPEAN SALES OFFICES

The Bergquist Co./Europe
Bramenberg 9a
3755 BT Eemnes
The Netherlands
Phone: 31-35-5380684
Fax: 31-35-5380295
Peter de Vries, European Sales Director

GERMANY

Bergquist ITC GmbH
Haderslebener Str. 19A, D-25421
Pinneberg
Tel: 49-4101-803-230
Fax: 49-4101-803-100

ENGLAND

Bergquist UK Ltd.
Unit 27 Darin Court
Crownhill Ind. Est.
Milton Keynes MK80AD
Tel: 44-1908-263663
Fax: 44-1908-263773

ASIAN SALES OFFICES

KOREA

The Bergquist Company, Korea Ltd.
324-7, Dang Jung-Dong
Kun Po-Si
Kyung Gi-Do
435-030 Seoul, Korea
Telephone: 82-343-457-8345
Direct: 82-11-341-0330
Fax: 82-343-457-8344
S.K. Chung, Director

HONG KONG

Hong Kong Sales Office & Warehouse
Block B, Rm. 9-16, 10/F
Veristrong Industrial Centre
34-36 Au Pui Wan Street,
Fo Tan, Shatin, N.T., Hong Kong
Frank Weng, Sales Manager
Telephone: 852-2698-5006
Direct Line: 852-2690-9296
Fax Line: 852-2690-2344
Frank Wong, Sales Manager

INTERNATIONAL AGENTS

AUSTRALIA	MALAYSIA
AUSTRIA	MEXICO
BELGIUM	NEW ZEALAND
BRAZIL	NORWAY
CANADA	PORTUGAL
CHINA	RUSSIA
DENMARK	SINGAPORE
FINLAND	SPAIN
FRANCE	SWEDEN
HOLLAND	SWITZERLAND
HONG KONG	TAIWAN
ISRAEL	THAILAND
ITALY	TURKEY
JAPAN	



5300 Edina Industrial Blvd. ❖ Minneapolis, MN 55439

Toll Free: 800/347-4572 ❖ Phone: 952/835-2322 ❖ Fax: 952/835-4156

X-ON Electronics

Largest Supplier of Electrical and Electronic Components

Click to view similar products for [bergquist company manufacturer](#):

Other Similar products are found below :

[SIL-PAD 2000 150MMX150MM SHEET](#) [GP2000S40-0.040-02-4/4](#) [GPEMI1.0-0.060-01-0816](#) [SPA2000-0.020-00-1012](#) [TGP6000ULM-0.125-12-0816](#) [803265](#) [GPEMI1.0-0.040-01-0816](#) [GP3500ULM-G-0.100-12-0816](#) [TGP12000ULM-0.080-00-0808](#) [GP1500-0.160-02-0816](#) [TGP3000ULM-0.080-02-0816](#) [SIL-PAD K6 300MMX300MM SHEET](#) [GP1500-0.200-02-0816](#) [SP980-0.009-00-1212](#) [GPEMI1.0-0.100-01-0816](#) [GPA3000-0.125-01-0816](#) [TGP12000ULM-0.100-00-0808](#) [TGP12000ULM-0.060-00-0808](#) [TGP3000ULM-0.120-02-0816](#) [803263](#) [GP1000SF-0.100-02-0816](#) [GPHC1000-0.010-02-0816](#) [GP1500S30-0.100-02-0816](#) [LF2000-00-00-30CC](#) [TGP3000ULM-0.100-02-0816](#) [TGP12000ULM-0.125-00-0808](#) [803269](#) [2015-54](#) [GPVOUS-0.080-00-4/4](#) [SP1200-0.016-AC-1212](#) [HF625-0.005-AC-1212](#) [SPA1500-0.010-00-4/4](#) [GP1500S30-0.250-02-0816](#) [SPA2000-0.015-AC-1012](#) [GP3500ULM-G-0.080-12-0816](#) [GPVO-0.160-01-0816](#) [GP1500S30-0.125-02-0816](#) [BP660P-0.008-00-1112](#) [LF3800LVO-00-150CC](#) [803790](#) [803266](#) [BP100-0.005-00-1/1](#) [SP1200-0.012-AC-1212](#) [SP1500ST-0.012-02-1012](#) [GP3500ULM-0.100-02-0816](#) [GF2000-00-600-50CC](#) [803262](#) [GPVOUS-0.160-AC-0816](#) [GPVOUS-B-0.040-01-0816](#) [803268](#)