

Table of Contents

Introduction	2	Sil-Pad® Thermally Conductive Insulators	45
Thermal Properties and Testing	4	Sil-Pad Comparison Data	46
Interface Material Selection Guide	5	Frequently Asked Questions	47
Gap Pad® Thermally Conductive Materials	6	Choosing Sil-Pad Thermally Conductive Insulators	48
Gap Pad Comparison Data	7	Mechanical, Electrical and Thermal Properties	50
Frequently Asked Questions	8	Sil-Pad Applications	52
Gap Pad VO®	9	Sil-Pad Selection Table	52
Gap Pad VO Soft®	10	Sil-Pad 400	54
Gap Pad VO Ultra Soft	11	Sil-Pad 800	55
Gap Pad I000SF	12	Sil-Pad 900S	56
Gap Pad HC1000	13	Sil-Pad 980	57
Gap Pad I500	14	Sil-Pad I100ST	58
Gap Pad I500R	15	Sil-Pad A1500	59
Gap Pad A2000	16	Sil-Pad I500ST	60
Gap Pad 2000S40	17	Sil-Pad I750	61
Gap Pad 2500S20	18	Sil-Pad 2000	62
Gap Pad 2500	19	Sil-Pad A2000	63
Gap Pad A3000	20	Sil-Pad K-4	64
Gap Pad 3000S30	21	Sil-Pad K-6	65
Gap Pad 5000S35	22	Sil-Pad K-10	66
Gap Filler 1000 (Two-Part)	23	Q-Pad® II	67
Gap Filler I100SF (Two-Part)	24	Q-Pad 3	68
Gap Filler Gel I500 (One-Part)	25	Poly-Pad® 400	69
Gap Filler 2000 (Two-Part)	26	Poly-Pad 1000	70
Gap Filler 3500S35 (Two-Part)	27	Poly-Pad K-4	71
TIC™ Thermal Interface Compound	28	Poly-Pad K-10	72
Comparison Data and Frequently Asked Questions	28	Sil-Pad Tubes	73
TIC I000G	29	Sil-Pad Shield	74
TIC I000A	30	Bond-Ply® and Liqui-Bond® Adhesives	75
TIC 4000	31	Bond-Ply and Liqui-Bond Comparison Data	76
Hi-Flow® Phase Change Interface Materials	32	Frequently Asked Questions	76
Hi-Flow Comparison Data	33	Bond-Ply 100	77
Frequently Asked Questions	34	Bond-Ply 400	78
Hi-Flow I05	35	Bond-Ply 660B	79
Hi-Flow I15-AC	36	Liqui-Bond SA 1000 (One-Part)	80
Hi-Flow 225F-AC	37	Liqui-Bond SA 2000 (One-Part)	81
Hi-Flow 225FT	38	Solutions for Surface Mount Applications	83
Hi-Flow 225UF	39	Ordering Information	85
Hi-Flow 225UT	40	Sil-Pad Configurations - Imperial	87
Hi-Flow 225U	41	Hi-Flow Configurations - Imperial	90
Hi-Flow 625	42	Sil-Pad Configurations - Metric	91
Hi-Flow 300P	43	Hi-Flow Configurations - Metric	94
Hi-Flow 300G	44	Sil-Pad Shield Configurations - Imperial	95

World Leader in Thermal Management Through Technology, Innovation and Service

At Bergquist, developing high quality components for the electronics industry is our first priority. As a world-leading manufacturer with state-of-the-art facilities, we serve a multitude of industries worldwide including automotive, computer, consumer electronics, military, motor control, power conversion, telecommunications and more.

We make it our business to know your business. We understand your problems. We also know that there will always be a better way to help you reach your goals and objectives. To that end, our company continually invests considerable time and money into research and development. The Bergquist Company is focused on a single purpose – discovering the need, then developing and delivering technologically advanced solutions backed by superior service.

Bergquist Takes the Heat

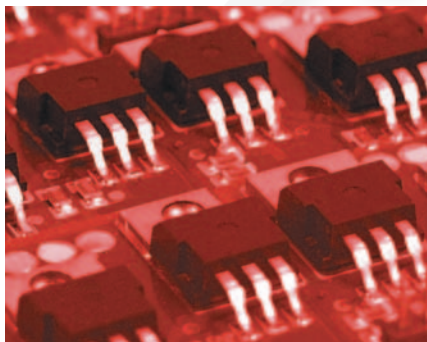

Thermal Management Products

Bergquist's Thermal Products Group is a world-leading developer and manufacturer of thermal management materials which provide product solutions to control and manage heat in electronic assemblies and printed circuit boards. Used by many of the world's largest OEMs in various industries including automotive, computer, power supply, military and motor control, these materials include:

Sil-Pad® – Thermally Conductive Insulators

Bond-Ply® and Liqui-Bond® – Thermally Conductive Adhesives

Gap Pad® – Thermally Conductive Gap Filling Materials

Hi-Flow® – Phase Change Interface Materials

TIC™ – Thermal Interface Compounds

Thermal Clad® – Insulated Metal Substrates

World Class Operations Around the Globe



Worldwide Locations

In the United States, the Thermal Products Group's 90,000 square-foot manufacturing facility is located in Cannon Falls, Minnesota. A 40,000 square-foot facility in Prescott, Wisconsin houses the Thermal Clad printed circuit board operations. A 130,000 square-foot facility in Chanhassen, Minnesota is the location for Bergquist's corporate headquarters and state-of-the-art research and development facilities. Worldwide, Bergquist has facilities in The Netherlands, Germany, the United Kingdom, Taiwan, South Korea, Hong Kong and China with sales representatives in 30 countries to support worldwide growth.

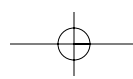

A Legacy of Industry-Leading Technology

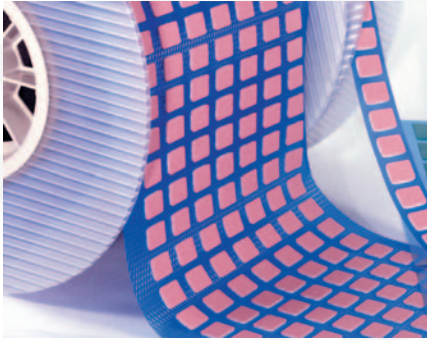

New Product Innovation

For over 40 years, outstanding quality, innovation and engineering have been hallmarks of The Bergquist Company. Today, developing innovative products for the electronics industry remains our first priority. Bergquist has developed over 260 materials which provide thermal solutions for a wide variety of electronic applications. Many of our products were originally developed to satisfy a customer request for a specific material designed to perform to their particular specifications. This "can do" attitude and customized technology has earned The Bergquist Company its ISO 9001:2000 certification.

Research and Development at the Speed of Change



R&D Facilities

Keeping pace in today's aggressive electronics industry demands continual anticipation of change and the ability to develop customer-driven solutions quickly and efficiently. Our Chanhassen headquarters features a state-of-the-art development laboratory and engineering department staffed with highly skilled chemical engineers, laboratory technicians and manufacturing engineers – all dedicated to researching, developing and testing new materials. From such dedication have come many industry-standard proprietary products including Thermal Clad, Sil-Pad, Gap Pad, Bond-Ply and Hi-Flow materials.

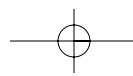
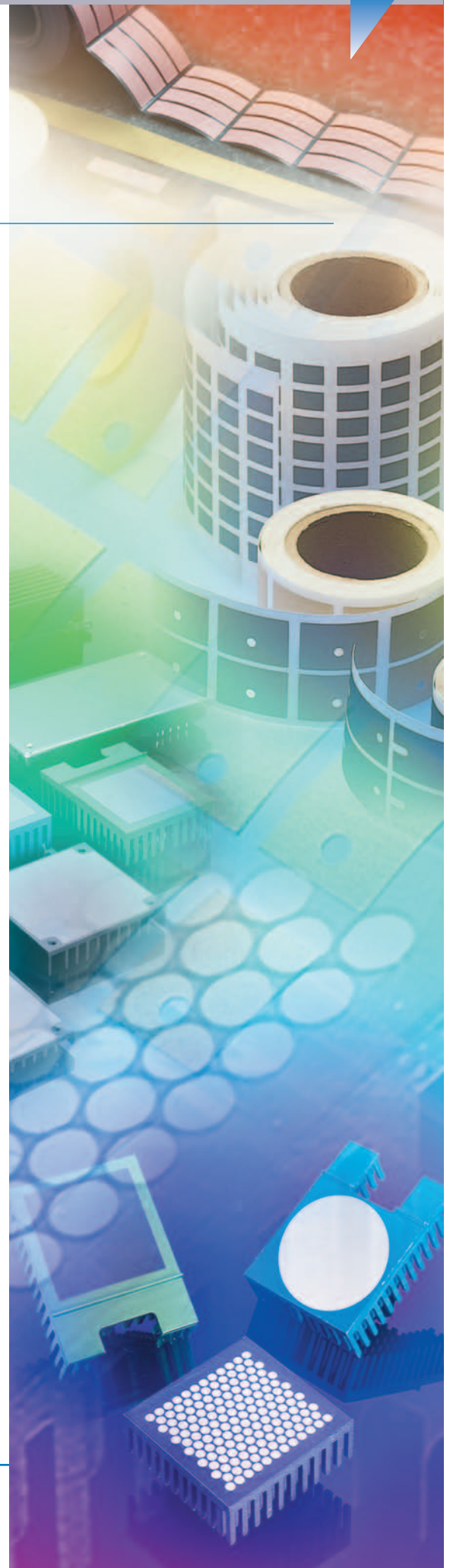

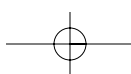

Thermal Properties and Testing

Thermal Conductivity

The time rate of heat flow through a unit area producing a unit temperature difference across a unit thickness.

$$k = \frac{dq \cdot z}{dt \cdot A \cdot \Delta T}$$

Thermal conductivity is an inherent or absolute property of the material.

Thermal Impedance

A property of a particular assembly measured by the ratio of the temperature difference between two surfaces to the steady-state heat flow through them.

$$Z_{\theta} = \frac{z}{k \cdot A} + R_i$$

Factors affecting thermal impedance include:

Area: Increasing the area of thermal contact decreases thermal impedance.

Thickness: Increasing the insulator thickness increases thermal impedance.

Pressure: Increasing mounting pressure under ideal conditions decreases thermal impedance.

Time: Thermal impedance decreases over time.

Measurement: Thermal impedance is affected by the method of temperature measurement.

Thermal Impedance Per Bergquist TO-220 Thermal Performance (25°C Cold Plate Testing)

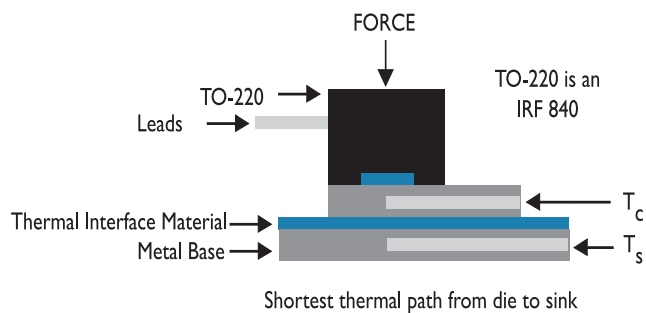

$$Z_{\theta} = \frac{\Delta T}{P_D}$$

Thermal Resistance

The opposition to the flow of heat through a unit area of material across an undefined thickness.

$$R_{\theta} = \frac{z}{k}$$

Thermal resistance varies with thickness.

Test Methods – ASTM D5470

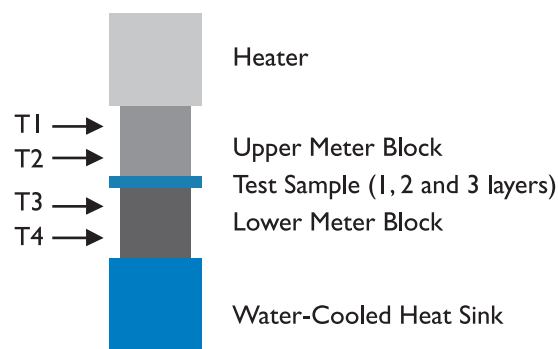

2 in. diameter stack (ref. 3.14 in²) – 10-500 psi, 1 hour per layer

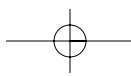
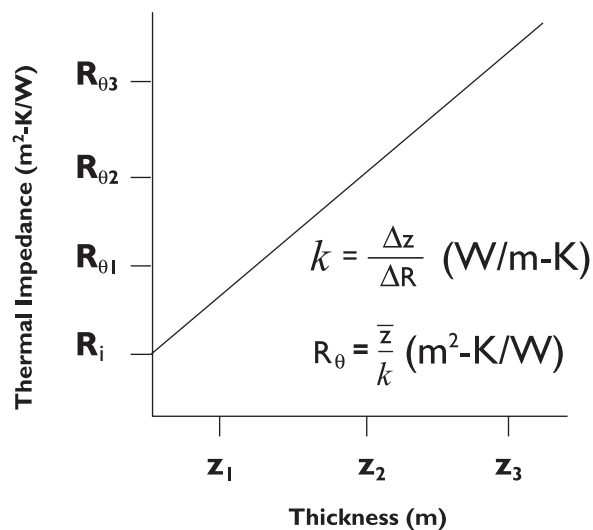

Interface Material Selection Guide

INTRODUCTION

PRODUCT OVERVIEW		INTERFACE APPLICATIONS					MOUNTING METHODS			TYPICAL CONVERTED OPTIONS						
Market Applications	Products	Discrete Power Devices for Power Supplies, Computers, Telecom (Thru-Hole)	Active Power Components: Capacitors, Inductors, Resistors	Electronic Modules for Automotive: Motor & Wiper Controls, Anti-Lock, etc.	Electronic Modules for Telecom and Power Supplies	Computer Applications: CPU, GPU, ASICs, Hard Drives	Electrical Insulator	Clip, Low Pressure	Screw/Rivets, High Pressure	Not Applicable	Sheet Stock	Roll Form, Continuous	Standard Configurations	Custom External Shapes	Custom Internal Features	Standard PSA Offerings
Grease Replacement Materials	Q-Pad II	T		T	T	T		T	T		A	A	A	A	A	A
	Q-Pad 3	T		T	T	T		T	T		A	A	A	A	A	A
	Hi-Flow 105	T				AS		T			A	A	A	A	A	A
	Hi-Flow 115-AC	T				T		T			A	A	A	A	A	A
	Hi-Flow 300G	T				T		T	AS		A	A	A	A	A	A
	Hi-Flow 225F-AC	T				T		T			A	A	A	AS		
	Hi-Flow 225FT					T		T			A	A	A	AS		
	Hi-Flow 225UT							T			A	A	A	AS		
	Hi-Flow 225U							T			A	A	A	AS		
Hi-Flow 225UF							T			A	A	A	AS			
Grease Replacement Materials - Insulated	Hi-Flow 625	T					T	T			A	A	A	A	A	A
	Hi-Flow 300P	T					T	T			A	A	A	A	A	A
Bonding - Thin Film	Bond-Ply 660B	T				T			T		A	A	A	A	A	
Bonding - Fiberglass	Bond-Ply 100	T				T			T		A	A	A	A	A	
Bonding - Unreinforced	Bond-Ply 400	T				T			T		A	A	A	A	A	
Sil-Pad - Fiberglass	Sil-Pad 400	T		T	T		T	T	T		A	A	A	A	A	A
	Sil-Pad 800	T		T	T		T	T			A	A	A	A	A	A
	Sil-Pad 900S	T		T	T		T	T	T		A	A	A	A	A	A
	Sil-Pad 980			T	T		T		T		A	A	A	A	A	A
	Sil-Pad 1100ST	T		T	T		T	T	T		A	A	A	A	A	A
	Sil-Pad A1500	T		T	T		T	T	T		A	A	A	A	A	A
	Sil-Pad 1500ST	T		T	T		T	T	T		A	A	A	A	A	A
	Sil-Pad 1750	T		T	T		T	T	T		A	A	A	A	A	A
	Sil-Pad 2000	T		T	T		T	AS	T		A	A	A	A	A	A
	Sil-Pad A2000	T		T	T		T	AS	T		A	A	A	A	A	A
Sil-Pad - Thin Film Polyimide	Sil-Pad K-4	T		T	T		T	T	T		A	A	A	A	A	A
	Sil-Pad K-6	T		T	T		T	T	T		A	A	A	A	A	A
	Sil-Pad K-10	T		T	T		T	T	T		A	A	A	A	A	A
Gap Pad	Gap Pad VO	T	T	T	T	T	T	T			A	A*	A	A	AS	A
	Gap Pad VO Soft	T	T	T	T	T	T	T			A	A*	A	A	AS	A
	Gap Pad VO Ultra Soft	T	T	T	T	T	T	T			A	A*	A	A	AS	A
	Gap Pad 1000SF	T	T	T	T	T	T	T			A		A	A	AS	
	Gap Pad HC1000	T	T				T	T			A	A*	A	A	A	
	Gap Pad 1500	T	T				T	T			A	A*	A	A	AS	
	Gap Pad 1500R	T	T	T			T	T			A	A*	A	A	A	
	Gap Pad A2000	T	T			T	AS	T			A	A*	A	A	A	
	Gap Pad 2000S40	T	T			T	AS	T			A		A	A	A	
	Gap Pad 2500S20	T	T			T	AS	T			A		A	A	A	
	Gap Pad 2500	T	T			T	AS	T			A		A	A	A	
	Gap Pad A3000	T	T	T	T	AS	T	T			A	A*	A	A	A	
	Gap Pad 3000S30	T	T	T	T	AS	T	T			A		A	A	A	
Gap Pad 5000S35	T	T	T	T	AS	T	T					A	A	A		
Gap Filler	Gap Filler 1000		T	T	T		AS	T					A			
	Gap Filler 1100SF		T	T	T	T	AS	T					A			
	Gap Filler 2000		T	T	T		AS	T					A			
	Gap Filler Gel 1500		T	T	T	AS	AS	T					A			
	Gap Filler 3500S35		T	T	T	AS	AS	T					A			
Liquid Adhesive	Liqui-Bond SA 1000	T		T			AS			T			A			
	Liqui-Bond SA 2000	T		T			AS			T			A			

T = Typical; AS = Application-Specific (contact Bergquist Sales); A = Available; * = Roll stock configurations are limited — contact your Bergquist Sales Representative for more information. Note: For Hi-Flow 225UT, Hi-Flow 225FT, and Hi-Flow 225F-AC, the adhesive is not a pressure sensitive adhesive (PSA).

Gap Pad® Thermally Conductive Materials

Solution-Driven Thermal Management Products for Electronic Devices

A Complete Range of Choices for Filling Air Gaps and Enhancing Thermal Conductivity

The Bergquist Company, a world leader in thermal interface materials, developed the Gap Pad family to meet the electronic industry's growing need for interface materials with greater conformability, higher thermal performance and easier application.

The extensive Gap Pad family provides an effective thermal interface between heat sinks and electronic devices where uneven surface topography, air gaps and rough surface textures are present. Bergquist application specialists work closely with customers to specify the proper Gap Pad material for each unique thermal management requirement.

GAP PAD

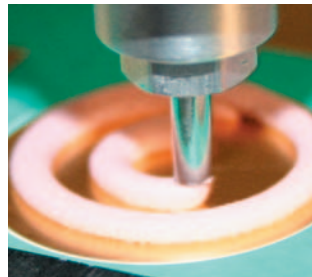

Features

Each of the many products within the Gap Pad family is unique in its construction, properties and performance. Following is an overview of the important features offered by the Gap Pad family.

- Low-modulus polymer material
- Available with fiberglass/rubber carriers or in a non-reinforced version
- Special fillers to achieve specific thermal and conformability characteristics
- Highly conformable to uneven and rough surfaces
- Electrically isolating
- Natural tack on one or both sides with protective liner
- Variety of thicknesses and hardnesses
- Range of thermal conductivities
- Available in sheets and die-cut parts

Benefits

Gap Pad thermal products are designed to improve an assembly's thermal performance and reliability while saving time and money. Specifically:

- Eliminates air gaps to reduce thermal resistance
- High conformability reduces interfacial resistance
- Low-stress vibration dampening
- Shock absorbing
- Easy material handling
- Simplified application
- Puncture, shear and tear resistance
- Improved performance for high-heat assemblies
- Compatible with automated dispensing equipment

Options

Some Gap Pad products have special features for particular applications, including:

- Available with or without adhesive
- Rubber-coated fiberglass reinforcement
- Thicknesses from 0.010" to 0.250"
- Available in custom die-cut parts, sheets and rolls (converted or unconverted)
- Custom thicknesses and constructions
- Adhesive or natural inherent tack
- Silicone-free Gap Pad available in thicknesses of 0.010" - 0.125"
- Gap Fillers are well suited for automated dispensing

We produce thousands of specials. Tooling charges vary depending on tolerance and complexity of the part.

Applications

Gap Pad products are well suited to a wide variety of electronics, automotive, medical, aerospace and military applications such as:

- Between an IC and a heat sink or chassis. Typical packages include BGA's, QFP, SMT power components and magnetics
- Between a semiconductor and heat sink
- CD-ROM/DVD cooling
- Heat pipe assemblies
- RDRAM memory modules
- DDR SDRAM
- Hard drive cooling
- Power supply
- Signal amplifiers
- Between other heat-generating devices and chassis

Gap Pad® Comparison Data

Conductivity, Hardness and General Overview

Gap Pad Thermal Conductivity vs. Hardness

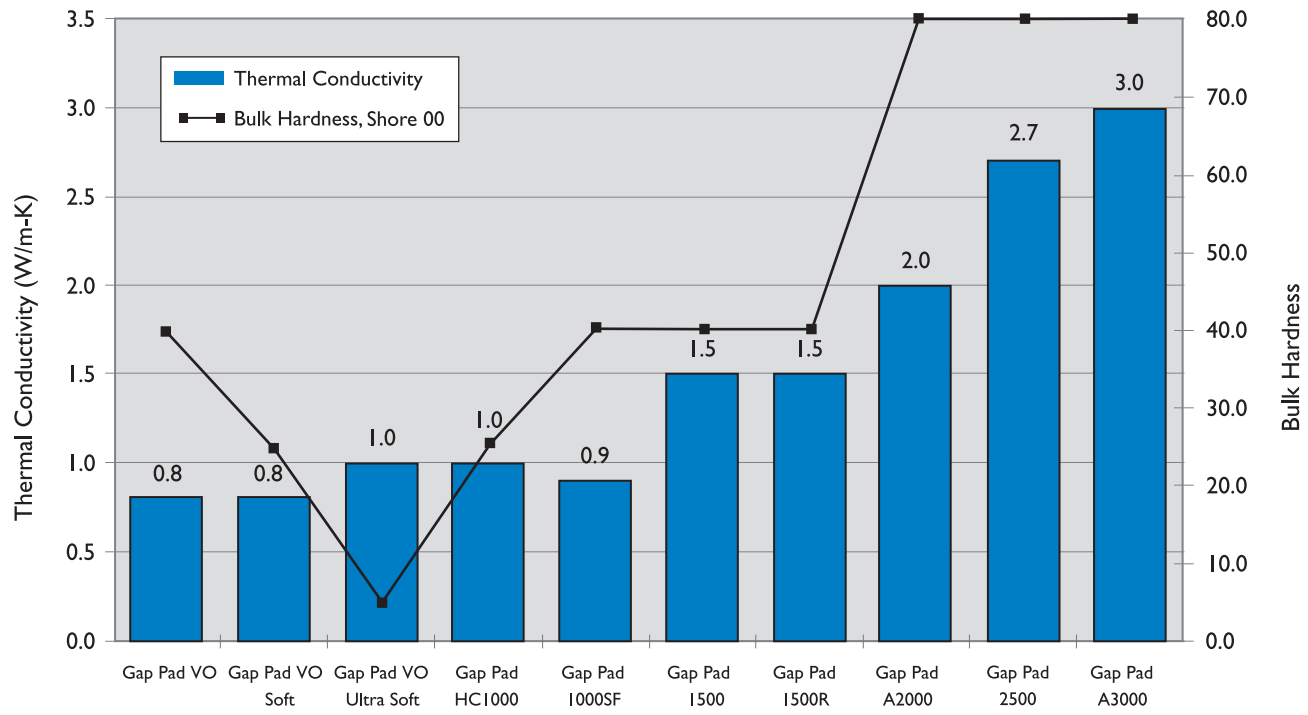

GAP PAD

Gap Pad "S-Class" Thermal Conductivity vs. Hardness

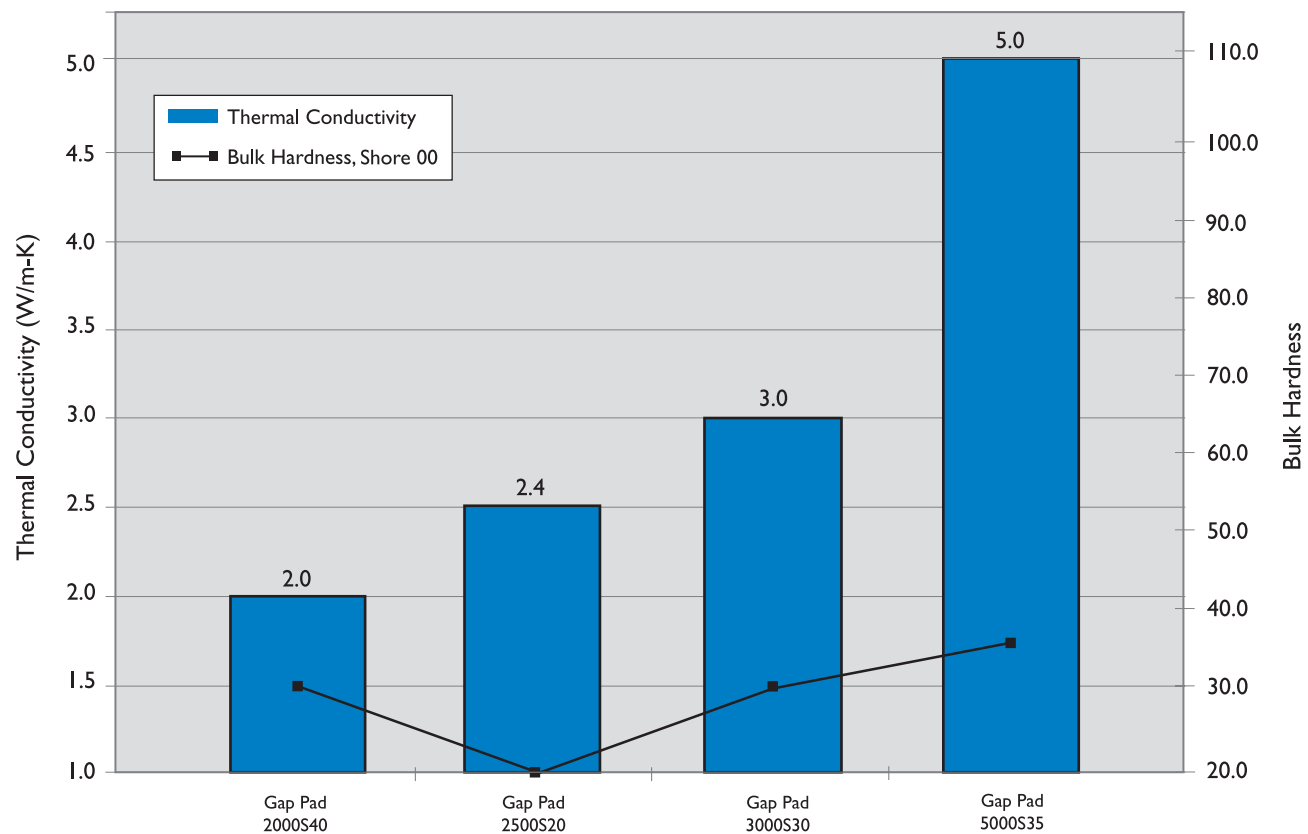

Frequently Asked Questions

Q: What thermal conductivity test method was used to achieve the values given on the data sheets?

A: A test fixture is utilized that meets the specifications outlined in ASTM D5470.

Q: Is Gap Pad offered with an adhesive?

A: Currently, Gap Pad VO, Gap Pad VO Soft, and Gap Pad VO Ultra Soft are offered with or without an adhesive on the Sil-Pad 800/900 carrier-side of the material. The remaining surface has natural inherent tack. All other Gap Pads have inherent tack.

Q: Is the adhesive repositionable?

A: Depending on the surface being applied to, if care is taken, the pad may be repositioned. Special care should be taken when removing the pad from aluminum or anodized surfaces to avoid tearing or delamination.

Q: What is meant by “natural tack”?

A: The characteristic of the rubber itself has a natural inherent tack, without the addition of an adhesive. As with adhesive-backed products, the surfaces with natural tack may help in the assembly process to temporarily hold the pad in place while the application is being assembled. Unlike adhesive-backed products, inherent tack does not have a thermal penalty since the rubber itself has the tack. Tack strength varies from one Gap Pad product to the next.

Q: Can Gap Pad with natural tack be repositioned?

A: Again, depending on the material that the pad is applied to, in most cases they are repositionable. Care should be taken when removing the pad from aluminum or anodized surfaces as to avoid tearing or delaminating the pad. The side with natural tack is always easier to reposition than an adhesive side.

Q: Is Gap Pad reworkable?

A: Depending on the application and the pad being used, Gap Pad has been reworked in the past. Bergquist has customers that are currently using the same pad for reassembling their applications after burn-in processes and after fieldwork repairs. However, this is left up to the design engineer's judgment as to whether or not the Gap Pad will withstand reuse.

Q: Is liquid Gap Filler reworkable?

A: It is highly dependent on the application and its surface topography. Liquid Gap Filler will cure with low adhesive strength to the application surfaces.

Q: Will heat make the material softer?

A: From -60°C to 200°C, there is no significant variance in hardness for silicone Gap Pads and Gap Fillers.

Q: What is the shelf life of Gap Pad?

A: Shelf life for Gap Pad is one (1) year after date of manufacture. For Gap Pad with adhesive, the shelf life is six (6) months after the date of manufacture. After these dates, inherent tack and adhesive properties should be recharacterized.

Q: How is extraction testing performed?

A: The test method used is the Bellcore Extraction method #TR-NWT-000930; refer to Bergquist Application Note #56.

Q: What are the upper processing temperature limits for Gap Pad and for how long can Gap Pad be exposed to them?

A: Gap Pad VO materials and Gap Pad A3000 are more stable at elevated temperatures. Gap Pad in general can be exposed to temporary processing temperatures of 250°C for five minutes and 300°C for one minute.

Q: Is Gap Pad electrically isolating?

A: Yes, all Gap Pad materials are electrically isolating. However, keep in mind that Gap Pad is designed to FILL gaps and is not recommended for applications where high mounting pressure is exerted on the Gap Pad.

Q: How much force will the pad place on my device?

A: Refer to the Pressure vs. Deflection charts in Bergquist Application Note #116.

Q: Will Gap Pad and Gap Filler work in my application? What size gaps will Gap Pad and Gap Filler accommodate?

A: Gap Pad and Gap Filler can be used wherever air can be replaced, such as between a heat-generating device and a heat sink, heat spreader or housing. This can be done using one sheet of Gap Pad or individual pieces of appropriate thicknesses, or by using Gap Filler if stack-up tolerances and height variations are significant.

Q: What is meant by “compliance” and “conformability,” and why is this important?

A: The better a Gap Pad complies and conforms to a rough or stepped surface, the less interfacial resistance will be present due to air voids and air gaps. This leads to a lower overall thermal resistance of the pad between the two interfaces.

Q: Is anything given off by the material (e.g. extractables, outgassing)?

A: 1) Silicone Gap Pad and Gap Fillers, like all soft silicone materials, can extract silicone fluid (refer to Bergquist Application Note #56). Also note that Gap Pad and Gap Filler have some of the lowest extraction values for silicone-based gap filling products on the market and if your application requires no silicone, see our line of Sil-Free material.

2) Primarily for aerospace applications, outgassing data is detailed in Bergquist Application Note #117, tested per ASTM E595.

Q: Why does the data sheet describe the hardness rating as a bulk rubber hardness?

A: A reinforcement carrier is generally utilized in Bergquist Gap Pads for ease of handling. When testing hardness, the reinforcement carrier can alter the test results and incorrectly depict thinner materials as being harder. To eliminate this error, a 250 mil rubber puck is molded with no reinforcement carrier. The puck is then tested for hardness. The Shore hardness is recorded after a 30 second delay.

Gap Pad VO®

Conformable, Thermally Conductive Material for Filling Air Gaps

Features and Benefits

- Thermal conductivity: 0.8 W/m-K
- Enhanced puncture, shear and tear resistance
- Conformable gap filling material
- Electrically isolating

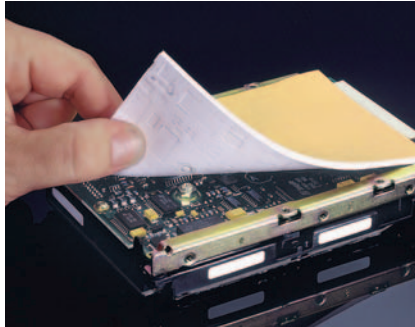

Gap Pad VO is a cost-effective, thermally conductive interface material. The material is a filled, thermally conductive polymer supplied on a rubber-coated fiberglass carrier allowing for easy material handling. The conformable nature of Gap Pad VO allows the pad to fill in air gaps between PC boards and heat sinks or a metal chassis.

Note: Resultant thickness is defined as the final gap thickness of the application.

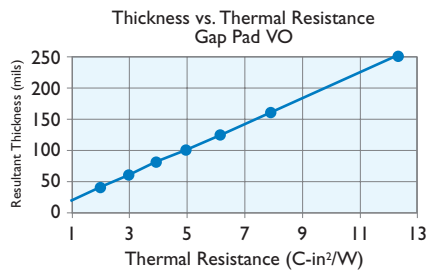

TYPICAL PROPERTIES OF GAP PAD VO			
PROPERTY	IMPERIAL VALUE	METRIC VALUE	TEST METHOD
Color	Gold/Pink	Gold/Pink	Visual
Reinforcement Carrier	Sil-Pad	Sil-Pad	—
Thickness (inch) / (mm)	0.020 to 0.250	0.508 to 6.350	ASTM D374
Inherent Surface Tack (1- or 2-sided)	I	I	—
Density (g/cc)	1.6	1.6	ASTM D792
Heat Capacity (J/g-K)	1.0	1.0	ASTM E1269
Hardness, Bulk Rubber (Shore 00) (1)	40	40	ASTM D2240
Young's Modulus (psi) / (kPa) (2)	100	689	ASTM D575
Continuous Use Temp (°F) / (°C)	-76 to 392	-60 to 200	—
ELECTRICAL			
Dielectric Breakdown Voltage (Vac)	>6000	>6000	ASTM D149
Dielectric Constant (1000 Hz)	5.5	5.5	ASTM D150
Volume Resistivity (Ohm-meter)	10 ¹¹	10 ¹¹	ASTM D257
Flame Rating	V-O	V-O	U.L. 94
THERMAL			
Thermal Conductivity (W/m-K)	0.8	0.8	ASTM D5470

1) Thirty second delay value Shore 00 hardness scale.
2) Young's Modulus, calculated using 0.01 in/min. step rate of strain with a sample size of 0.79 inch². For more information on Gap Pad modulus, refer to Bergquist Application Note #116.

GAP PAD

Typical Applications Include:

- Telecommunications
- Computer and peripherals
- Power conversion
- Between heat-generating semiconductors and a heat sink
- Area where heat needs to be transferred to a frame, chassis, or other type of heat spreader
- Between heat-generating magnetic components and a heat sink

Configurations Available:

- Sheet form and die-cut parts

Building a Part Number

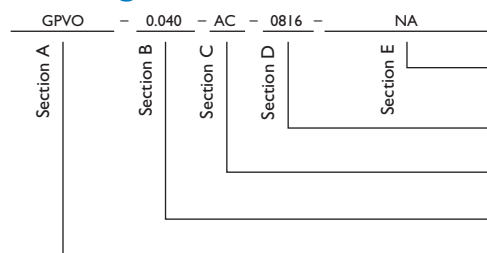

Standard Options

◀ *example*

NA = Selected standard option. If not selecting a standard option, insert company name, drawing number, and revision level.

0816 = Standard sheet size 8" x 16" or
00 = custom configuration

AC = Adhesive, one side
00 = No pressure sensitive adhesive

Standard thicknesses available: 0.020", 0.040", 0.060", 0.080", 0.100", 0.125", 0.160", 0.200", 0.250"

GPVO = Gap Pad VO Material

Note: To build a part number, visit our website at www.bergquistcompany.com.
Gap Pad®: U.S. Patent 5,679,457 and others.

Gap Pad VO Soft®

Highly Conformable, Thermally Conductive Material for Filling Air Gaps

Features and Benefits

- Thermal conductivity: 0.8 W/m-K
- Conformable, low hardness
- Enhanced puncture, shear and tear resistance
- Electrically isolating

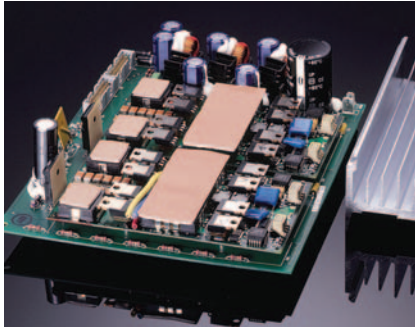

Gap Pad VO Soft is recommended for applications that require a minimum amount of pressure on components. Gap Pad VO Soft is a highly conformable, low-modulus, filled-silicone polymer on a rubber-coated fiberglass carrier. The material can be used as an interface where one side is in contact with a leaded device.

Note: Resultant thickness is defined as the final gap thickness of the application.

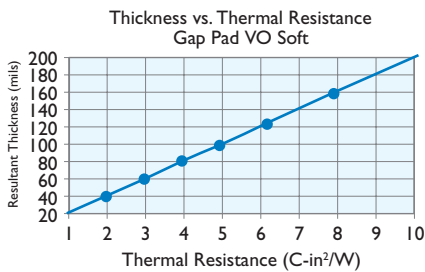

TYPICAL PROPERTIES OF GAP PAD VO SOFT			
PROPERTY	IMPERIAL VALUE	METRIC VALUE	TEST METHOD
Color	Mauve/Pink	Mauve/Pink	Visual
Reinforcement Carrier	Sil-Pad	Sil-Pad	—
Thickness (inch) / (mm)	0.020 to 0.200	0.508 to 5.080	ASTM D374
Inherent Surface Tack (1- or 2-sided)	I	I	—
Density (g/cc)	1.6	1.6	ASTM D792
Heat Capacity (J/g-K)	1.0	1.0	ASTM E1269
Hardness, Bulk Rubber (Shore 00) (1)	25	25	ASTM D2240
Young's Modulus (psi) / (kPa) (2)	40	275	ASTM D575
Continuous Use Temp (°F) / (°C)	-76 to 392	-60 to 200	—
ELECTRICAL			
Dielectric Breakdown Voltage (Vac)	>6000	>6000	ASTM D149
Dielectric Constant (1000 Hz)	5.5	5.5	ASTM D150
Volume Resistivity (Ohm-meter)	10 ¹¹	10 ¹¹	ASTM D257
Flame Rating	V-O	V-O	U.L. 94
THERMAL			
Thermal Conductivity (W/m-K)	0.8	0.8	ASTM D5470

1) Thirty second delay value Shore 00 hardness scale.
 2) Young's Modulus, calculated using 0.01 in/min. step rate of strain with a sample size of 0.79 inch". For more information on Gap Pad modulus, refer to Bergquist Application Note #116.

Typical Applications Include:

- Telecommunications
- Computer and peripherals
- Power conversion
- Between heat-generating semiconductors or magnetic components and a heat sink
- Area where heat needs to be transferred to a frame, chassis, or other type of heat spreader

Configurations Available:

- Sheet form and die-cut parts

Building a Part Number

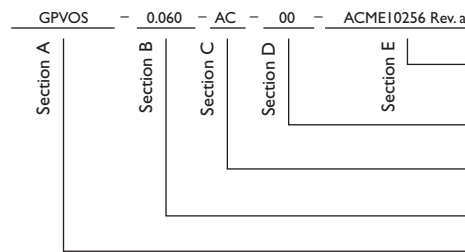

Standard Options

NA = Selected standard option. If not selecting a standard option, insert company name, drawing number, and revision level.

0816 = Standard sheet size 8" x 16", or 00 = custom configuration

AC = Pressure sensitive adhesive, one side
 00 = No pressure sensitive adhesive

Standard thicknesses available: 0.020", 0.040", 0.060", 0.080", 0.100", 0.125", 0.160", 0.200"

GPVOS = Gap Pad VO Soft Material

Note: To build a part number, visit our website at www.bergquistcompany.com.

Gap Pad®: U.S. Patent 5,679,457 and others.

Gap Pad® VO Ultra Soft

Ultra Conformable, Thermally Conductive Material for Filling Air Gaps

Features and Benefits

- Thermal conductivity: 1.0 W/m-K
- Highly conformable, low hardness
- "Gel-like" modulus
- Designed for low-stress applications
- Puncture, shear and tear resistant



Gap Pad VO Ultra Soft is recommended for applications that require a minimum amount of pressure on components. The viscoelastic nature of the material also gives excellent low-stress vibration dampening and shock absorbing characteristics. Gap Pad VO Ultra Soft is an electrically isolating material, which allows its use in applications requiring isolation between heat sinks and high-voltage, bare-leaded devices.

Note: Resultant thickness is defined as the final gap thickness of the application.

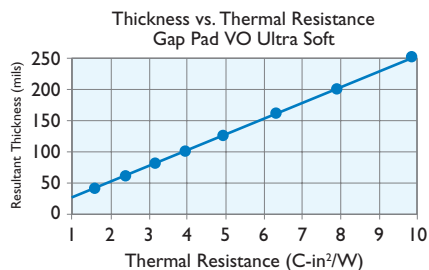

TYPICAL PROPERTIES OF GAP PAD VO ULTRA SOFT			
PROPERTY	IMPERIAL VALUE	METRIC VALUE	TEST METHOD
Color	Mauve/Pink	Mauve/Pink	Visual
Reinforcement Carrier	Sil-Pad	Sil-Pad	—
Thickness (inch) / (mm)	0.020 to 0.250	0.508 to 6.350	ASTM D374
Inherent Surface Tack (1- or 2-sided)	1	1	—
Density (g/cc)	1.6	1.6	ASTM D792
Heat Capacity (J/g-K)	1.0	1.0	ASTM E1269
Hardness, Bulk Rubber (Shore 00) (1)	5	5	ASTM D2240
Young's Modulus (psi) / (kPa) (2)	8	55	ASTM D575
Continuous Use Temp (°F) / (°C)	-76 to 392	-60 to 200	—
ELECTRICAL			
Dielectric Breakdown Voltage (Vac)	>6000	>6000	ASTM D149
Dielectric Constant (1000 Hz)	5.5	5.5	ASTM D150
Volume Resistivity (Ohm-meter)	10 ¹¹	10 ¹¹	ASTM D257
Flame Rating	V-O	V-O	U.L. 94
THERMAL			
Thermal Conductivity (W/m-K)	1.0	1.0	ASTM D5470

1) Thirty second delay value Shore 00 hardness scale.
 2) Young's Modulus, calculated using 0.01 in/min. step rate of strain with a sample size of 0.79 inch². For more information on Gap Pad modulus, refer to Bergquist Application Note #116.

GAP PAD

Typical Applications Include:

- Telecommunications
- Computer and peripherals
- Power conversion
- Between heat-generating semiconductors or magnetic components and a heat sink
- Area where heat needs to be transferred to a frame, chassis, or other type of heat spreader

Configurations Available:

- Sheet form and die-cut parts

Building a Part Number

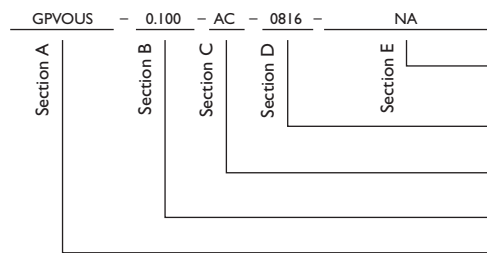

Standard Options

◀ example
 NA = Selected standard option. If not selecting a standard option, insert company name, drawing number, and revision level.
 0816 = Standard sheet size 8" x 16", or
 00 = custom configuration
 AC = Adhesive, one side
 00 = No adhesive
 Standard thicknesses available: 0.020", 0.040", 0.060", 0.080", 0.100", 0.125", 0.160", 0.200", 0.250"
 GPVVOUS = Gap Pad VO Ultra Soft Material

Note: To build a part number, visit our website at www.bergquistcompany.com.

Gap Pad®: U.S. Patent 5,679,457 and others.

Gap Pad® I000SF

Thermally Conductive, Silicone-Free Gap Filling Material

Features and Benefits

- Thermal conductivity: 0.9 W/m-K
- No silicone outgassing
- No silicone extraction
- Reduced tack on one side to aid in application assembly

GAP PAD

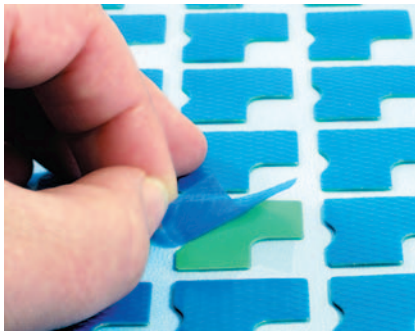

The new Gap Pad I000SF is a thermally conductive, electrically insulating, silicone-free polymer specially designed for silicone-sensitive applications. The material is ideal for applications with high standoff and flatness tolerances. Gap Pad I000SF is reinforced for easy material handling and added durability during assembly. The material is available with a protective liner on both sides of the material.

Note: Resultant thickness is defined as the final gap thickness of the application.

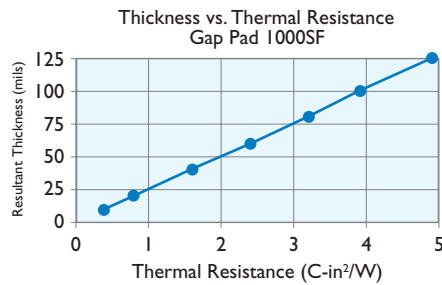

TYPICAL PROPERTIES OF GAP PAD I000SF			
PROPERTY	IMPERIAL VALUE	METRIC VALUE	TEST METHOD
Color	Green	Green	Visual
Reinforcement Carrier	Fiberglass	Fiberglass	—
Thickness (inch) / (mm)	0.010 to 0.125	0.254 to 3.175	ASTM D374
Inherent Surface Tack (1- or 2-sided)	2	2	—
Density (g/cc)	2.0	2.0	ASTM D792
Heat Capacity (J/g-K)	1.1	1.1	ASTM E1269
Hardness, Bulk Rubber (Shore 00) (1)	40	40	ASTM D2240
Young's Modulus (psi) / (kPa) (2)	34	234	ASTM D575
Continuous Use Temp (°F) / (°C)	-76 to 257	-60 to 125	—
ELECTRICAL			
Dielectric Breakdown Voltage (Vac)	>6000	>6000	ASTM D149
Dielectric Constant (1000 Hz)	5.0	5.0	ASTM D150
Volume Resistivity (Ohm-meter)	10 ¹⁰	10 ¹⁰	ASTM D257
Flame Rating	V-1	V-1	U.L. 94
THERMAL			
Thermal Conductivity (W/m-K)	0.9	0.9	ASTM D5470

1) Thirty second delay value Shore 00 hardness scale.
2) Young's Modulus, calculated using 0.01 in/min. step rate of strain with a sample size of 0.79 inch". For more information on Gap Pad modulus, refer to Bergquist Application Note #116.

Typical Applications Include:

- Digital disk drives / CD-ROM
- Automotive modules
- Fiber optics modules

Configurations Available:

- Sheet form
- Die-cut parts

Building a Part Number

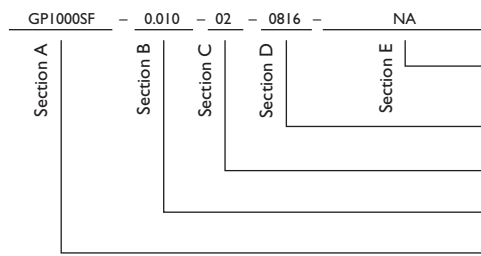

Standard Options

◀ example
 NA = Selected standard option. If not selecting a standard option, insert company name, drawing number, and revision level.
 0806 = Standard sheet size 8" x 16", or
 00 = custom configuration
 02 = Natural tack, both sides
 Standard thicknesses available: 0.010", 0.015", 0.020", 0.040", 0.060", 0.080", 0.100", 0.125"
 GPI000SF = Gap Pad I000SF Material

Note: To build a part number, visit our website at www.bergquistcompany.com.

Gap Pad®: U.S. Patent 5,679,457 and others.

Gap Pad® HCI000

“Gel-Like” Modulus Gap Filling Material

Features and Benefits

- Thermal conductivity: 1.0 W/m-K
- Highly conformable, low hardness
- “Gel-like” modulus
- Fiberglass reinforced for puncture, shear and tear resistance

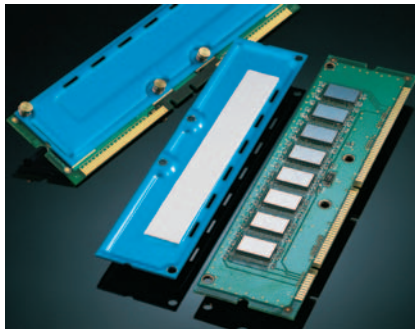

Gap Pad HC 1000 is an extremely conformable, low-modulus polymer that acts as a thermal interface and electrical insulator between electronic components and heat sinks. The “gel-like” modulus allows this material to fill air gaps to enhance the thermal performance of electronic systems. Gap Pad HCI000 is offered with removable protective liners on both sides of the material.

Note: Resultant thickness is defined as the final gap thickness of the application.

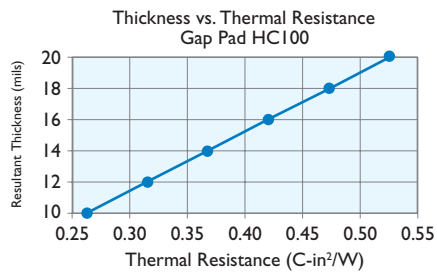

TYPICAL PROPERTIES OF GAP PAD HCI000			
PROPERTY	IMPERIAL VALUE	METRIC VALUE	TEST METHOD
Color	Gray	Gray	Visual
Reinforcement Carrier	Fiberglass	Fiberglass	—
Thickness (inch) / (mm)	0.010 to 0.020	0.254 to 0.508	ASTM D374
Inherent Surface Tack (1- or 2-sided)	2	2	—
Density (g/cc)	1.6	1.6	ASTM D792
Heat Capacity (J/g-K)	1.0	1.0	ASTM E1269
Hardness, Bulk Rubber (Shore 00) (1)	25	25	ASTM D2240
Young's Modulus (psi) / (kPa) (2)	40	275	ASTM D575
Continuous Use Temp (°F) / (°C)	-76 to 392	-60 to 200	—
ELECTRICAL			
Dielectric Breakdown Voltage (Vac)	>5000	>5000	ASTM D149
Dielectric Constant (1000 Hz)	5.5	5.5	ASTM D150
Volume Resistivity (Ohm-meter)	10 ¹¹	10 ¹¹	ASTM D257
Flame Rating	V-O	V-O	U.L. 94
THERMAL			
Thermal Conductivity (W/m-K)	1.0	1.0	ASTM D5470

1) Thirty second delay value Shore 00 hardness scale.
 2) Young's Modulus, calculated using 0.01 in/min. step rate of strain with a sample size of 0.79 inch² and 0.020 inches thick. For more information on Gap Pad modulus, refer to Bergquist Application Note #116.

GAP PAD

Typical Applications Include:

- Computer and peripherals
- Telecommunications
- Heat interfaces to frames, chassis, or other heat spreading devices
- RDRAM™ memory modules / chip scale packages
- CDROM / DVD cooling
- Areas where irregular surfaces need to make a thermal interface to a heat sink
- DDR SDRAM memory modules
- FBDIMM modules

Configurations Available:

- Sheet form, die-cut parts, and roll form (converted or unconverted)

Building a Part Number

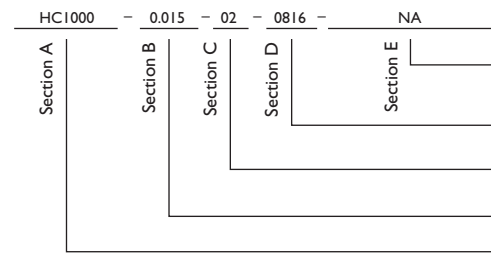

Standard Options

◀ example
 NA = Selected standard option. If not selecting a standard option, insert company name, drawing number, and revision level.
 0816 = Standard sheet size 8" x 16", or
 00 = custom configuration
 02 = Natural tack, both sides
 Standard thicknesses available: 0.010", 0.015", 0.020"
 HCI000 = High Compliance 1000 Material

Note: To build a part number, visit our website at www.bergquistcompany.com.
 Gap Pad®: U.S. Patent 5,679,457 and others.

Gap Pad® I500

Thermally Conductive, Unreinforced Gap Filling Material

Features and Benefits

- Thermal conductivity: 1.5 W/m-K
- Unreinforced construction for additional compliancy
- Conformable, low hardness
- Electrically isolating

GAP PAD

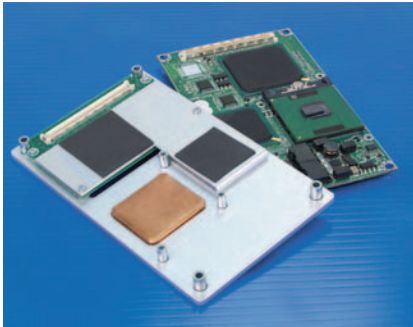

Gap Pad I500 has an ideal filler blend that gives it a low-modulus characteristic that maintains optimal thermal performance yet still allows for easy handling. The natural tack on both sides of the material allows for good compliance to adjacent surfaces of components, minimizing interfacial resistance.

Note: Resultant thickness is defined as the final gap thickness of the application.

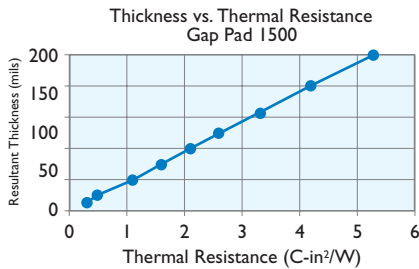

TYPICAL PROPERTIES OF GAP PAD I500			
PROPERTY	IMPERIAL VALUE	METRIC VALUE	TEST METHOD
Color	Black	Black	Visual
Reinforcement Carrier	—	—	—
Thickness (inch) / (mm)	0.020 to 0.200	0.508 to 5.080	ASTM D374
Inherent Surface Tack (1- or 2-sided)	2	2	—
Density (g/cc)	2.1	2.1	ASTM D792
Heat Capacity (J/g-K)	1.0	1.0	ASTM E1269
Hardness, Bulk Rubber (Shore 00) (1)	40	40	ASTM D2240
Young's Modulus (psi) / (kPa) (2)	45	310	ASTM D575
Continuous Use Temp (°F) / (°C)	-76 to 392	-60 to 200	—
ELECTRICAL			
Dielectric Breakdown Voltage (Vac)	>6000	>6000	ASTM D149
Dielectric Constant (1000 Hz)	5.5	5.5	ASTM D150
Volume Resistivity (Ohm-meter)	10 ¹¹	10 ¹¹	ASTM D257
Flame Rating	V-O	V-O	U.L. 94
THERMAL			
Thermal Conductivity (W/m-K)	1.5	1.5	ASTM D5470

1) Thirty second delay value Shore 00 hardness scale.
2) Young's Modulus, calculated using 0.01 in/min. step rate of strain with a sample size of 0.79 inch'. For more information on Gap Pad modulus, refer to Bergquist Application Note #116.

Typical Applications Include:

- Telecommunications
- Computer and peripherals
- Power conversion
- RDRAM™ memory modules / chip scale packages
- Areas where heat needs to be transferred to a frame chassis or other type of heat spreader

Configurations Available:

- Sheet form and die-cut parts

Building a Part Number

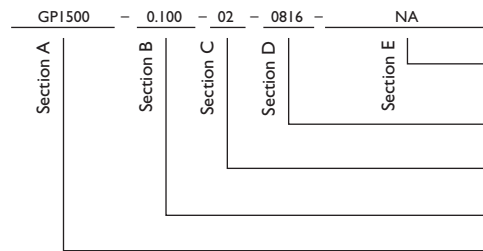

Standard Options

NA = Selected standard option. If not selecting a standard option, insert company name, drawing number, and revision level.

0816 = Standard sheet size 8" x 16", or 00 = custom configuration

02 = Natural tack, both sides

Standard thicknesses available: 0.020", 0.040", 0.060", 0.080", 0.100", 0.125", 0.160", 0.200"

GPI500 = Gap Pad 1500 Material

Note: To build a part number, visit our website at www.bergquistcompany.com.

Gap Pad®: U.S. Patent 5,679,457 and others.

Gap Pad® I500R

Thermally Conductive, Reinforced Gap Filling Material

Features and Benefits

- Thermal conductivity: 1.5 W/m-K
- Fiberglass reinforced for puncture, shear and tear resistance
- Easy release construction
- Electrically isolating

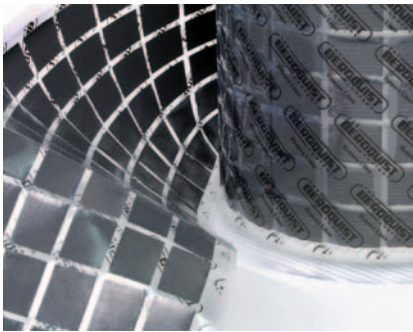

Gap Pad I500R has the same highly conformable, low-modulus polymer as the standard Gap Pad 1500. The fiberglass reinforcement allows for easy material handling and enhances puncture, shear and tear resistance. The natural tack on both sides of the material allows for good compliance to mating surfaces of components, further reducing thermal resistance.

Note: Resultant thickness is defined as the final gap thickness of the application.

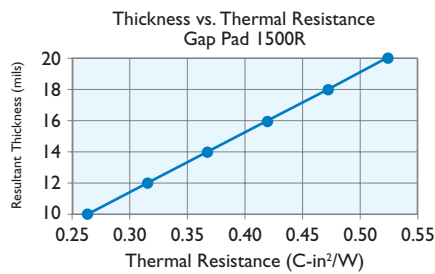

TYPICAL PROPERTIES OF GAP PAD I500R			
PROPERTY	IMPERIAL VALUE	METRIC VALUE	TEST METHOD
Color	Black	Black	Visual
Reinforcement Carrier	Fiberglass	Fiberglass	—
Thickness (inch) / (mm)	0.010 to 0.020	0.254 to 0.508	ASTM D374
Inherent Surface Tack (1- or 2-sided)	2	2	—
Density (g/cc)	2.1	2.1	ASTM D792
Heat Capacity (J/g-K)	1.3	1.3	ASTM E1269
Hardness, Bulk Rubber (Shore 00) (1)	40	40	ASTM D2240
Young's Modulus (psi) / (kPa) (2)	45	310	ASTM D575
Continuous Use Temp (°F) / (°C)	-76 to 392	-60 to 200	—
ELECTRICAL			
Dielectric Breakdown Voltage (Vac)	>6000	>6000	ASTM D149
Dielectric Constant (1000 Hz)	6.0	6.0	ASTM D150
Volume Resistivity (Ohm-meter)	10 ¹¹	10 ¹¹	ASTM D257
Flame Rating	V-O	V-O	U.L. 94
THERMAL			
Thermal Conductivity (W/m-K)	1.5	1.5	ASTM D5470

1) Thirty second delay value Shore 00 hardness scale.
2) Young's Modulus, calculated using 0.01 in/min. step rate of strain with a sample size of 0.79 inch². For more information on Gap Pad modulus, refer to Bergquist Application Note #116.

GAP PAD

Typical Applications Include:

- Telecommunications
- Computer and peripherals
- Power conversion
- RDRAM™ memory modules / chip scale packages
- Areas where heat needs to be transferred to a frame chassis or other type of heat spreader

Configurations Available:

- Sheet form, die-cut parts, and roll form (converted or unconverted)

Building a Part Number

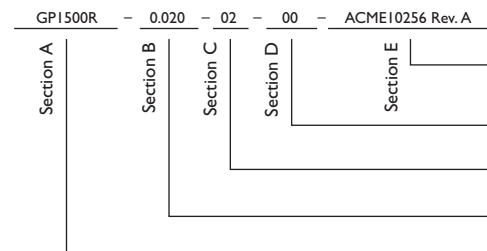

Standard Options

◀ example

NA = Selected standard option. If not selecting a standard option, insert company name, drawing number, and revision level.

0816 = Standard sheet size 8" x 16", or
00 = custom configuration

02 = Natural tack, both sides

Standard thicknesses available: 0.010", 0.015", 0.020"

GPI500R = Gap Pad 1500R Material

Note: To build a part number, visit our website at www.bergquistcompany.com.

Gap Pad®: U.S. Patent 5,679,457 and others.

Gap Pad® A2000

High Performance, Thermally Conductive Gap Filling Material

Features and Benefits

- Thermal conductivity: 2.0 W/m-K
- Fiberglass reinforced for puncture, shear and tear resistance
- Electrically isolating

GAP PAD

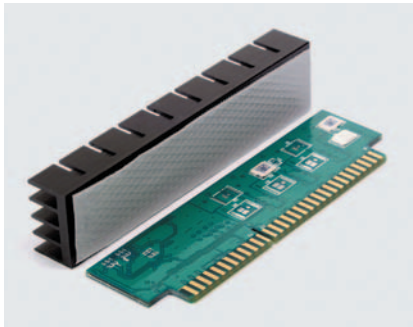

Gap Pad A2000 acts as a thermal interface and electrical insulator between electronic components and heat sinks. In the thickness range of 10 to 40 mil, Gap Pad A2000 is supplied with natural tack on both sides, allowing for excellent compliance to the adjacent surfaces of components. The 40 mil material thickness is supplied with lower tack on one side, allowing for burn-in processes and easy rework.

Note: Resultant thickness is defined as the final gap thickness of the application.

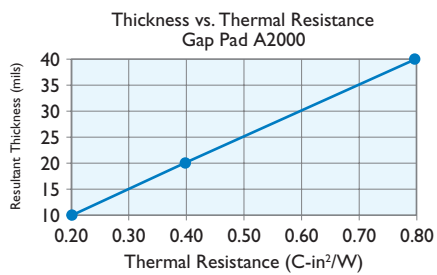

TYPICAL PROPERTIES OF GAP PAD A2000			
PROPERTY	IMPERIAL VALUE	METRIC VALUE	TEST METHOD
Color	Gray	Gray	Visual
Reinforcement Carrier	Fiberglass	Fiberglass	—
Thickness (inch) / (mm)	0.010 to 0.040	0.254 to 1.016	ASTM D374
Inherent Surface Tack (1- or 2-sided)	2	2	—
Density (g/cc)	2.9	2.9	ASTM D792
Heat Capacity (J/g-K)	1.0	1.0	ASTM E1269
Hardness, Bulk Rubber (Shore 00) (1)	80	80	ASTM D2240
Young's Modulus (psi) / (kPa) (2)	55	379	ASTM D575
Continuous Use Temp (°F) / (°C)	-76 to 392	-60 to 200	—
ELECTRICAL			
Dielectric Breakdown Voltage (Vac)	>4000	>4000	ASTM D149
Dielectric Constant (1000 Hz)	6.0	6.0	ASTM D150
Volume Resistivity (Ohm-meter)	10 ¹¹	10 ¹¹	ASTM D257
Flame Rating	V-O	V-O	U.L. 94
THERMAL			
Thermal Conductivity (W/m-K)	2.0	2.0	ASTM D5470

1) Thirty second delay value Shore 00 hardness scale.
2) Young's Modulus, calculated using 0.01 in/min. step rate of strain with a sample size of 0.79 inch'. For more information on Gap Pad modulus, refer to Bergquist Application Note #116.

Typical Applications Include:

- Computer and peripherals; between CPU and heat spreader
- Telecommunications
- Heat pipe assemblies
- RDRAM™ memory modules
- CDROM / DVD cooling
- Areas where heat needs to be transferred to a frame chassis or other type of heat spreader
- DDR SDRAM memory modules

Configurations Available:

- Sheet form, die-cut parts and roll form (converted or unconverted)

Building a Part Number Standard Options

GPA2000 - 0.010 - 02 - 0816 - NA

Section A | Section B | Section C | Section D | Section E

NA = Selected standard option. If not selecting a standard option, insert company name, drawing number, and revision level.
0816 = Standard sheet size 8" x 16", or
00 = custom configuration
02 = Natural tack, both sides
Standard thicknesses available: 0.010", 0.015", 0.020", 0.040"
GPA2000 = Gap Pad A2000 Material

Note: To build a part number, visit our website at www.bergquistcompany.com.

Gap Pad®: U.S. Patent 5,679,457 and others.

Gap Pad® 2000S40

Highly Conformable, Thermally Conductive, Reinforced "S-Class" Gap Filling Material

Features and Benefits

- Thermal conductivity: 2.0 W/m-K
- Low "S-Class" thermal resistance at very low pressures
- Highly conformable, low hardness
- Designed for low-stress applications
- Fiberglass reinforced for puncture, shear and tear resistance

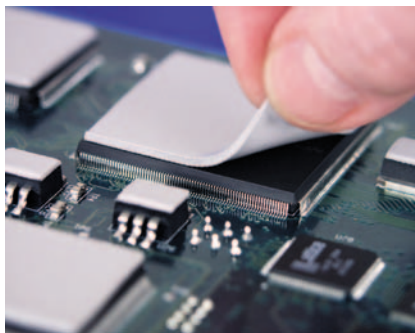

Gap Pad 2000S40 is recommended for low-stress applications that require a mid to high thermally conductive interface material. The highly conformable nature of the material allows the pad to fill in air voids and air gaps between PC boards and heat sinks or metal chassis with stepped topography, rough surfaces and high stack-up tolerances.

Gap Pad 2000S40 is electrically isolating, and well suited for applications requiring electrical isolation between heat sinks and high-voltage, bare-leaded devices. Gap Pad 2000S40 is a filled, thermally conductive polymer reinforced with a fiberglass carrier on one side, allowing for easy material handling and enhanced puncture, shear and tear resistance.

Note: Resultant thickness is defined as the final gap thickness of the application.

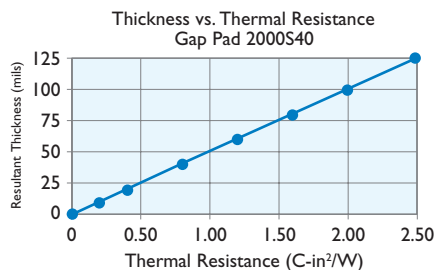

TYPICAL PROPERTIES OF GAP PAD 2000S40			
PROPERTY	IMPERIAL VALUE	METRIC VALUE	TEST METHOD
Color	Gray	Gray	Visual
Reinforcement Carrier	Fiberglass	Fiberglass	—
Thickness (inch) / (mm)	0.020 to 0.125	0.508 to 3.175	ASTM D374
Inherent Surface Tack (1- or 2-sided)	2	2	—
Density (g/cc)	2.9	2.9	ASTM D792
Heat Capacity (J/g-K)	0.6	0.6	ASTM E1269
Hardness, Bulk Rubber (Shore 00) (1)	30	30	ASTM D2240
Young's Modulus (psi) / (kPa) (2)	45	310	ASTM D575
Continuous Use Temp (°F) / (°C)	-76 to 392	-60 to 200	—
ELECTRICAL			
Dielectric Breakdown Voltage (Vac)	>5000	>5000	ASTM D149
Dielectric Constant (1000 Hz)	6.0	6.0	ASTM D150
Volume Resistivity (Ohm-meter)	10 ¹¹	10 ¹¹	ASTM D257
Flame Rating	V-O	V-O	U.L. 94
THERMAL			
Thermal Conductivity (W/m-K)	2.0	2.0	ASTM D5470

1) Thirty second delay value Shore 00 hardness scale.
 2) Young's Modulus, calculated using 0.01 in/min. step rate of strain with a sample size of 0.79 inch². For more information on Gap Pad modulus, refer to Bergquist Application Note #116.

GAP PAD

Typical Applications Include:

- Power electronics DC/DC; 1/4, 1/2, full bricks, etc.
- Mass storage devices
- Graphics card/processor/ASIC
- Wireline/wireless communications hardware
- Automotive engine/transmission controls

Configurations Available:

- Sheet form and die-cut parts

Building a Part Number

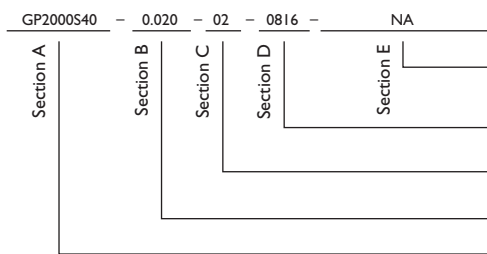

Standard Options

◀ example

NA = Selected standard option. If not selecting a standard option, insert company name, drawing number, and revision level.

0816 = Standard sheet size 8" x 16", or 00 = custom configuration

02 = Natural tack, both sides

Standard thicknesses available: 0.020", 0.040", 0.060", 0.080", 0.100", 0.125"

GP2000S40 = Gap Pad 2000S40 Material

Note: To build a part number, visit our website at www.bergquistcompany.com.

Gap Pad®: U.S. Patent 5,679,457 and others.

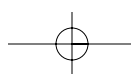

Gap Pad® 2500S20

Highly Conformable, Thermally Conductive, Reinforced “S-Class” Gap Filling Material

Features and Benefits

- Thermal conductivity: 2.4 W/m-K
- Low “S-Class” thermal resistance at ultra-low pressures
- Ultra conformable, “gel-like” modulus
- Designed for low-stress applications
- Fiberglass reinforced for puncture, shear and tear resistance

GAP PAD

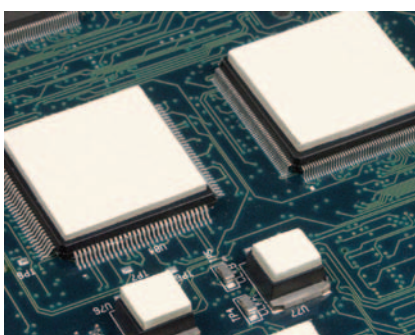

Gap Pad 2500S20 is a thermally conductive, reinforced material rated at a thermal conductivity of 2.4 W/m-K. The material is a filled-polymer material yielding extremely soft, elastic characteristics. The material is reinforced to provide easy handling, converting, added electrical isolation and tear resistance. Gap Pad 2500S20 is well suited for low-pressure applications that typically use fixed standoff or clip mounting. The material maintains a conformable, yet elastic nature that allows for excellent interfacing and wet-out characteristics, even to surfaces with high roughness and/or topography.

Gap Pad 2500S20 is offered with inherent natural tack on both sides of the material allowing for stick-in-place characteristics during application assembly. The material is supplied with protective liners on both sides.

Note: Resultant thickness is defined as the final gap thickness of the application.

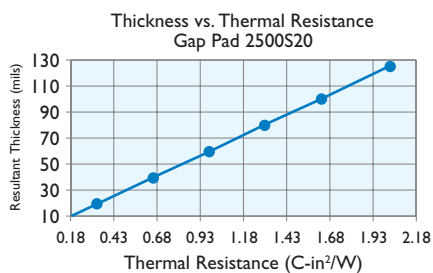

TYPICAL PROPERTIES OF GAP PAD 2500S20			
PROPERTY	IMPERIAL VALUE	METRIC VALUE	TEST METHOD
Color	Light Yellow	Light Yellow	Visual
Reinforcement Carrier	Fiberglass	Fiberglass	—
Thickness (inch) / (mm)	0.010 to 0.125	0.254 to 3.175	ASTM D374
Inherent Surface Tack (1- or 2-sided)	2	2	—
Density (g/cc)	3.1	3.1	ASTM D792
Heat Capacity (J/g-K)	1.0	1.0	ASTM E1269
Hardness, Bulk Rubber (Shore 00) (1)	20	20	ASTM D2240
Young's Modulus (psi) / (kPa) (2)	5	35	ASTM D575
Continuous Use Temp (°F) / (°C)	-76 to 392	-60 to 200	—
ELECTRICAL			
Dielectric Breakdown Voltage (Vac)	>3000	>3000	ASTM D149
Dielectric Constant (1000 Hz)	6.6	6.6	ASTM D150
Volume Resistivity (Ohm-meter)	10 ¹¹	10 ¹¹	ASTM D257
Flame Rating	V-O	V-O	U.L. 94
THERMAL			
Thermal Conductivity (W/m-K)	2.4	2.4	ASTM D5470

1) Thirty second delay value Shore 00 hardness scale.
2) Young's Modulus, calculated using 0.01 in/min. step rate of strain with a sample size of 0.79 inch". For more information on Gap Pad modulus, refer to Bergquist Application Note #116.

Typical Applications

- Between processors and heat sinks
- Between graphics chips and heat sinks
- DVD and CDROM electronics cooling
- Areas where heat needs to be transferred to a frame, chassis or other type of heat spreader

Configurations Available:

- Sheet form and die-cut parts

Building a Part Number

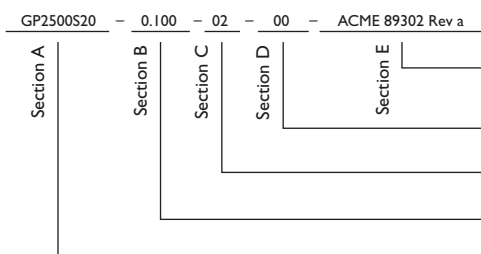

Standard Options

NA = Selected standard option. If not selecting a standard option, insert company name, drawing number, and revision level.
0816 = Standard sheet size 8" x 16", or
00 = custom configuration
02 = Natural tack, both sides
Standard thicknesses available: 0.010", 0.015", 0.020", 0.040", 0.060", 0.080", 0.100", 0.125"
GP2500S20 = Gap Pad 2500S20 Material

Note: To build a part number, visit our website at www.bergquistcompany.com.

Gap Pad®: U.S. Patent 5,679,457 and others.

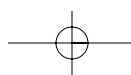

Gap Pad® 2500

Thermally Conductive, Unreinforced Gap Filling Material

Features and Benefits

- Thermal conductivity: 2.7 W/m-K
- High thermal performance, cost-effective solution
- Unreinforced construction for additional compliancy
- Medium compliancy and conformability

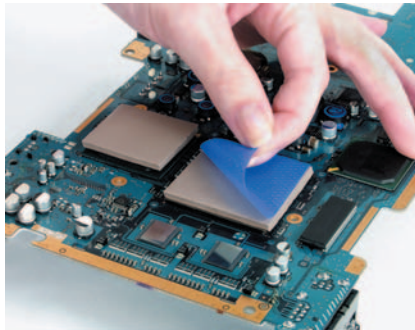

Gap Pad 2500 is a thermally conductive, electrically insulating, unreinforced gap filling material. Gap Pad 2500 is a filled-polymer material yielding an elastic polymer that allows for easy handling and converting without the need for reinforcement. These properties also allow for good wet-out and interfacing characteristics to surfaces with roughness and/or topography. All these characteristics make this material ideal for applications using either clip or screw-mounted assemblies.

Gap Pad 2500 is offered with inherent natural tack on both sides of the material allowing for stick-in-place characteristics during application assembly. The material is supplied with protective liners on both sides.

Note: Resultant thickness is defined as the final gap thickness of the application.

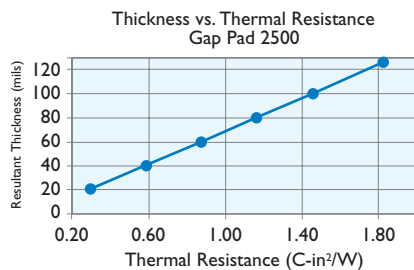

TYPICAL PROPERTIES OF GAP PAD 2500			
PROPERTY	IMPERIAL VALUE	METRIC VALUE	TEST METHOD
Color	Light Brown	Light Brown	Visual
Reinforcement Carrier	—	—	—
Thickness (inch) / (mm)	0.020 to 0.125	0.508 to 3.175	ASTM D374
Inherent Surface Tack (1- or 2-sided)	2	2	—
Density (g/cc)	3.1	3.1	ASTM D792
Heat Capacity (J/g-K)	1.0	1.0	ASTM E1269
Hardness, Bulk Rubber (Shore 00) (1)	80	80	ASTM D2240
Young's Modulus (psi) / (kPa) (2)	113	779	ASTM D575
Continuous Use Temp (°F) / (°C)	-76 to 392	-60 to 200	—
ELECTRICAL			
Dielectric Breakdown Voltage (Vac)	>6000	>6000	ASTM D149
Dielectric Constant (1000 Hz)	6.8	6.8	ASTM D150
Volume Resistivity (Ohm-meter)	10 ¹¹	10 ¹¹	ASTM D257
Flame Rating	V-O	V-O	U.L. 94
THERMAL			
Thermal Conductivity (W/m-K)	2.7	2.7	ASTM D5470

1) Thirty second delay value Shore 00 hardness scale.
2) Young's Modulus, calculated using 0.01 in/min. step rate of strain with a sample size of 0.79 inch². For more information on Gap Pad modulus, refer to Bergquist Application Note #116.

GAP PAD

Typical Applications Include:

- Multiple heat-generating components to a common heat sink
- Graphics chips to heat sinks
- Processors to heat sinks
- Mass storage drives
- Wireline / wireless communications hardware

Configurations Available:

- Sheet form and die-cut parts

Building a Part Number

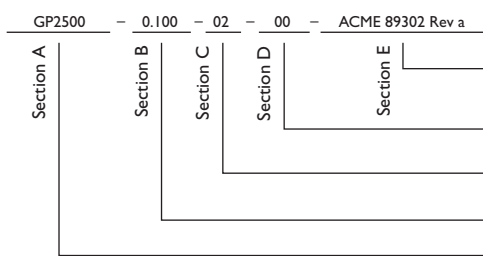

Standard Options

◀ example
NA = Selected standard option. If not selecting a standard option, insert company name, drawing number, and revision level.
0816 = Standard sheet size 8" x 16", or
00 = custom configuration
02 = Natural tack, both sides
Standard thicknesses available: 0.020", 0.040", 0.060", 0.080", 0.100", 0.125"
GP2500 = Gap Pad 2500 Material

Note: To build a part number, visit our website at www.bergquistcompany.com.

Gap Pad®: U.S. Patent 5,679,457 and others.

Gap Pad® A3000

Thermally Conductive, Reinforced Gap Filling Material

Features and Benefits

- Thermal conductivity: 2.6 W/m-K
- Fiberglass reinforced for puncture, shear and tear resistance
- Reduced tack on one side to aid in application assembly
- Electrically isolating

GAP PAD

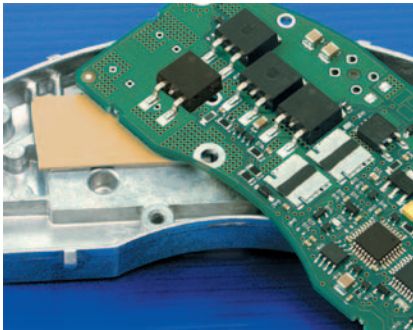

Gap Pad A3000 is a thermally conductive, filled-polymer laminate, supplied on a reinforcing mesh for added electrical isolation, easy material handling and enhanced puncture, shear and tear resistance. Gap Pad A3000 has a reinforcement layer on the dark gold side of the material that assists in burn-in and rework processes while the light gold and soft side of the material allows for added compliance.

Note: Resultant thickness is defined as the final gap thickness of the application.

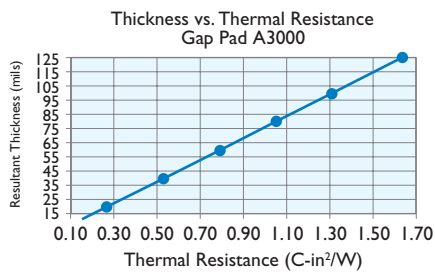

TYPICAL PROPERTIES OF GAP PAD A3000			
PROPERTY	IMPERIAL VALUE	METRIC VALUE	TEST METHOD
Color	Gold	Gold	Visual
Reinforcement Carrier	Fiberglass	Fiberglass	—
Thickness (inch) / (mm)	0.015 to 0.125	0.381 to 3.175	ASTM D374
Inherent Surface Tack (1- or 2-sided)	1	1	—
Density (g/cc)	3.2	3.2	ASTM D792
Heat Capacity (J/g-K)	1.0	1.0	ASTM E1269
Hardness, Bulk Rubber (Shore 00) (1)	80	80	ASTM D2240
Young's Modulus (psi) / (kPa) (2)	50	344	ASTM D575
Continuous Use Temp (°F) / (°C)	-76 to 392	-60 to 200	—
ELECTRICAL			
Dielectric Breakdown Voltage (Vac)	>5000	>5000	ASTM D149
Dielectric Constant (1000 Hz)	7.0	7.0	ASTM D150
Volume Resistivity (Ohm-meter)	10 ¹⁰	10 ¹⁰	ASTM D257
Flame Rating	V-O	V-O	U.L. 94
THERMAL			
Thermal Conductivity (W/m-K)	2.6	2.6	ASTM D5470

1) Thirty second delay value Shore 00 hardness scale.
 2) Young's Modulus, calculated using 0.01 in/min. step rate of strain with a sample size of 0.79 inch'. For more information on Gap Pad modulus, refer to Bergquist Application Note #116.

Typical Applications Include:

- Computer and peripherals
- Heat pipe assemblies
- CDRom / DVD cooling
- Area where heat needs to be transferred to a frame, chassis or other type of heat spreader
- Telecommunications
- RDRAM™ memory modules
- Between CPU and heat spreader

Configurations Available:

- Sheet form, die-cut parts and roll form (converted or unconverted)

Building a Part Number

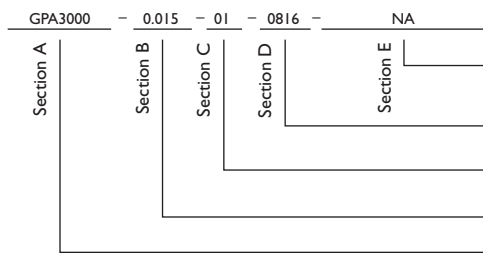

Standard Options

◀ example
 NA = Selected standard option. If not selecting a standard option, insert company name, drawing number, and revision level.
 0816 = Standard sheet size 8" x 16", or
 00 = custom configuration
 01 = Natural tack, one side
 Standard thicknesses available: 0.015", 0.020", 0.040", 0.060", 0.080", 0.100", 0.125"
 GPA3000 = Gap Pad A3000 Material

Note: To build a part number, visit our website at www.bergquistcompany.com.

Gap Pad®: U.S. Patent 5,679,457 and others.

Gap Pad® 3000S30

Thermally Conductive, Reinforced, Soft "S-Class" Gap Filling Material

Features and Benefits

- Thermal conductivity: 3.0 W/m-K
- Low "S-Class" thermal resistance at very low pressures
- Highly conformable, "S-Class" softness
- Designed for low-stress applications
- Fiberglass reinforced for puncture, shear and tear resistance

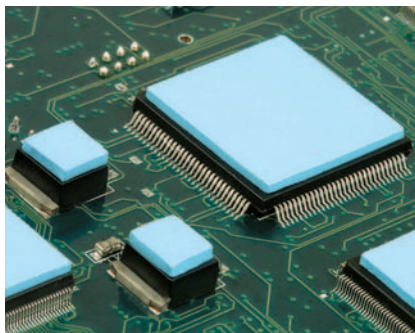

Gap Pad 3000S30 is a soft gap filling material rated at a thermal conductivity of 3 W/m-K. The material offers exceptional thermal performance at low pressures due to an all-new 3 W/m-K filler package and low-modulus resin formulation. It is reinforced to enhance material handling, puncture, shear and tear resistance. It is well suited for high performance, low-stress applications that typically use fixed standoff or clip mounting. Gap Pad 3000S30 maintains a conformable yet elastic nature that allows for excellent interfacing and wet-out characteristics, even to surfaces with high roughness and/or topography.

Gap Pad 3000S30 is offered with natural inherent tack on both sides of the material, eliminating the need for thermally-impeding adhesive layers. The material's natural inherent tack allows for stick-in-place characteristics during assembly. Gap Pad 3000S30 is supplied with protective liners on both sides.

Note: Resultant thickness is defined as the final gap thickness of the application.

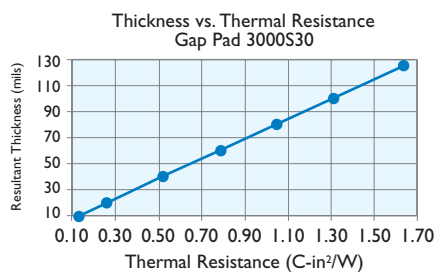

TYPICAL PROPERTIES OF GAP PAD 3000S30			
PROPERTY	IMPERIAL VALUE	METRIC VALUE	TEST METHOD
Color	Light Blue	Light Blue	Visual
Reinforcement Carrier	Fiberglass	Fiberglass	—
Thickness (inch) / (mm)	0.010 to 0.125	0.254 to 3.175	ASTM D374
Inherent Surface Tack (1- or 2-sided)	2	2	—
Density (g/cc)	3.2	3.2	ASTM D792
Heat Capacity (J/g-K)	1.0	1.0	ASTM E1269
Hardness, Bulk Rubber (Shore 00) (1)	30	30	ASTM D2240
Young's Modulus (psi) / (kPa) (2)	26	180	ASTM D575
Continuous Use Temp (°F) / (°C)	-76 to 392	-60 to 200	—
ELECTRICAL			
Dielectric Breakdown Voltage (Vac)	>3000	>3000	ASTM D149
Dielectric Constant (1000 Hz)	7.0	7.0	ASTM D150
Volume Resistivity (Ohm-meter)	10 ⁹	10 ⁹	ASTM D257
Flame Rating	V-O	V-O	U.L. 94
THERMAL			
Thermal Conductivity (W/m-K)	3.0	3.0	ASTM D5470

1) Thirty second delay value Shore 00 hardness scale.
2) Young's Modulus, calculated using 0.01 in/min. step rate of strain with a sample size of 0.79 inch². For more information on Gap Pad modulus, refer to Bergquist Application Note #116.

GAP PAD

Typical Applications:

- Processors
- Server S-RAMs
- Mass storage drives
- Wireline / wireless communications hardware
- Notebook computers
- BGA packages
- Power conversion

Configurations Available:

- Sheet form and die-cut parts available

Building a Part Number

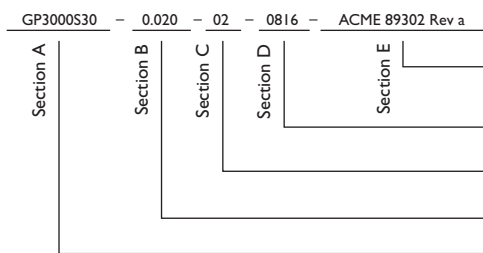

Standard Options

◀ example
NA = Selected standard option. If not selecting a standard option, insert company name, drawing number, and revision level.

0816 = Standard sheet size 8" x 16", or
00 = custom configuration

02 = Natural tack, both sides

Standard thicknesses available: 0.010", 0.015", 0.020",
0.040", 0.060", 0.080", 0.100", 0.125"

GP3000S30 = Gap Pad 3000S30 Material

Note: To build a part number, visit our website at www.bergquistcompany.com.

Gap Pad®: U.S. Patent 5,679,457 and others.

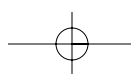

Gap Pad® 5000S35

High thermal conductivity plus "S-Class" softness and conformability

Features and Benefits

- High thermal conductivity: 5 W/m-K
- Highly conformable, "S-Class" softness
- Natural inherent tack reduces interfacial thermal resistance
- Conforms to demanding contours and maintains structural integrity with little or no stress applied to fragile component leads
- Fiberglass reinforced for puncture, shear and tear resistance
- Excellent thermal performance at low pressures

GAP PAD

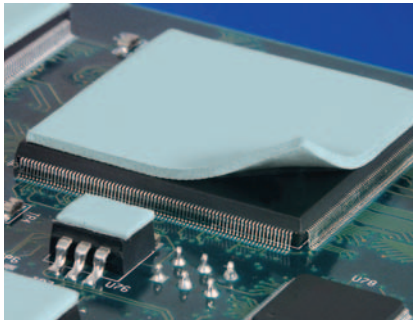

Gap Pad 5000S35 is a fiberglass-reinforced filler and polymer featuring a high thermal conductivity. The material yields extremely soft characteristics while maintaining elasticity and conformability. The fiberglass reinforcement provides easy handling and converting, added electrical isolation and tear resistance. The inherent natural tack on both sides assists in application and allows the product to effectively fill air gaps, enhancing the overall thermal performance. Gap Pad 5000S35 is ideal for high-performance applications at low mounting pressures.

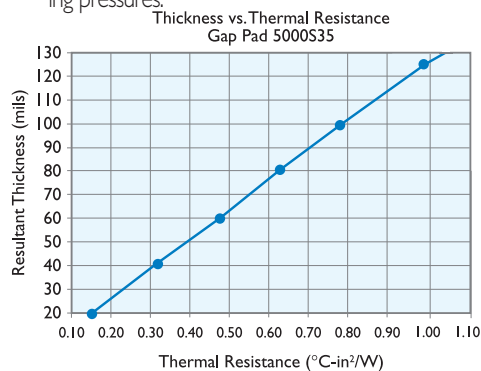

Note: Resultant thickness is defined as the final gap thickness of the application.

TYPICAL PROPERTIES OF GAP PAD 5000S35						
PROPERTY	IMPERIAL VALUE	METRIC VALUE	TEST METHOD			
Color	Light Green	Light Green	Visual			
Reinforcement Carrier	Fiberglass	Fiberglass	—			
Thickness (inch) / (mm)	0.02 to 0.125	0.508 to 3.175	ASTM D374			
Inherent Surface Tack (1 or 2 sided)	2	2	—			
Density (g/cc)	3.6	3.6	ASTM D792			
Heat Capacity (J/g-K)	1.0	1.0	ASTM C351			
Hardness Bulk Rubber (Shore 00) (1)	35	35	ASTM D2240			
Young's Modulus (psi) / (kPa) (2)	17.5	121	ASTM D575			
Continuous Use Temp (°F) / (°C)	-76 to 392	-60 to 200	—			
ELECTRICAL						
Dielectric Breakdown Voltage (Vac)	>5000	>5000	ASTM D149			
Dielectric Constant (1000 Hz)	7.5	7.5	ASTM D150			
Volume Resistivity (Ohm-meter)	10 ⁹	10 ⁹	ASTM D257			
Flame Rating	V-O	V-O	U.L. 94			
THERMAL						
Thermal Conductivity (W/m-K)	5.0	5.0	ASTM D5470			
THERMAL PERFORMANCE vs. PRESSURE						
	Pressure (psi)	10	25	50	100	200
TO-220 Thermal Performance (°C/W) (20 mil)		1.18	1.10	0.99	0.84	0.72
Thermal Impedance (°C-in²/W) (3)		0.21	0.18	0.15	0.14	0.12
TO-220 Thermal Performance (°C/W) (40 mil)		1.54	1.34	1.15	1.00	0.90
Thermal Impedance (°C-in²/W) (3)		0.30	0.28	0.25	0.22	0.13

1) One second delay value Shore 00 hardness scale. 2) Young's Modulus, calculated using 0.01 in/min. step rate of strain with a sample size of 0.79 inch. For more information on Gap Pad modulus, refer to Bergquist Application Note #116. 3) The ASTM D5470 test fixture was used. The recorded value includes interfacial thermal resistance. These values are provided for reference only. Actual application performance is directly related to the surface roughness, flatness and pressure applied.

Typical Applications

- CDROM / DVD ROM
- Voltage Regulator Modules (VRMs) and POLs
- Thermally-enhanced BGAs
- Memory packages / modules
- PC Board to chassis
- ASICs and DSPs

Configurations Available:

- Die-cut parts are available in any shape or size, separated or in sheet form
- Standard material thicknesses of 20, 40, 60, 80, 100 and 125 mil
- Custom thicknesses available upon request

Building a Part Number

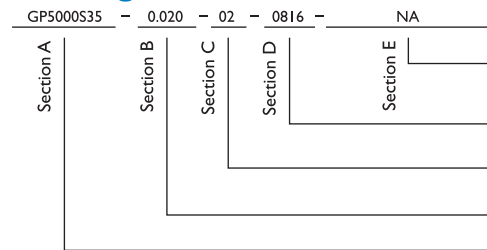

Note: To build a part number, visit our website at www.bergquistcompany.com.

Gap Pad®. U.S. Patent 5,679,457 and others.

Standard Options

- ◀ example
- NA = Selected standard option. If not selecting a standard option, insert company name, drawing number, and revision level.
- 0816 = Standard sheet size 8" x 16", or
- 00 = custom configuration
- 02 = Natural tack, both sides
- Standard thicknesses available: 0.020", 0.040", 0.060", 0.080", 0.100", 0.125"
- GP5000S35 = Gap Pad 5000S35 Material

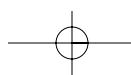

Gap Filler 1000 (Two-Part)

Thermally Conductive, Liquid Gap Filling Material

Features and Benefits

- Thermal conductivity: 1.0 W/m-K
- Ultra-conforming, designed for fragile and low-stress applications
- Ambient and accelerated cure schedules
- 100% solids – no cure by-products
- Excellent low and high temperature mechanical and chemical stability

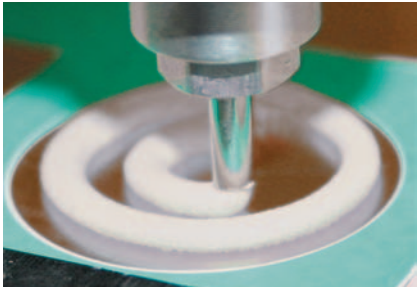

Gap Filler 1000 is a thermally conductive, liquid gap filling material. It is supplied as a two-component, room or elevated temperature curing system. The material is formulated to provide a balance of cured material properties highlighted by "gel-like" modulus and good compression set (memory). The result is a soft, thermally conductive, form-in-place elastomer ideal for coupling "hot" electronic components mounted on PC boards with an adjacent metal case or heat sink. Before cure, Gap Filler 1000 flows under pressure like a grease. After cure, it does not pump from the interface as a result of thermal cycling. Unlike thermal grease, the cured product is dry to the touch. Unlike cured gap filling materials, the liquid approach offers infinite thickness with little or no stress during displacement and eliminates the need for specific pad thickness and die-cut shapes for individual applications. Gap Filler 1000 is intended for use in thermal interface applications when a strong structural bond is not required.

Note: Resultant thickness is defined as the final gap thickness of the application.

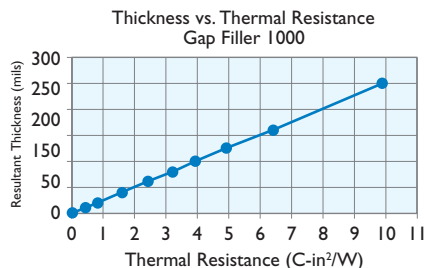

TYPICAL PROPERTIES OF GAP FILLER 1000			
PROPERTY	IMPERIAL VALUE	METRIC VALUE	TEST METHOD
Color / Part A	Gray	Gray	Visual
Color / Part B	White	White	Visual
Viscosity as Mixed (cps) (1)	100,000	100,000	ASTM D2196
Density (g/cc)	1.6	1.6	ASTM D792
Mix Ratio	1:1	1:1	—
Shelf Life @ 25°C (months)	6	6	—
PROPERTY AS CURED			
Color	Gray	Gray	Visual
Hardness (Shore 00) (2)	30	30	ASTM D2240
Heat Capacity (J/g-K)	1.0	1.0	ASTM E1269
Continuous Use Temp (°F) / (°C)	-76 to 347	-60 to 175	—
ELECTRICAL AS CURED			
Dielectric Strength (V/mil)	500	500	ASTM D149
Dielectric Constant (1000 Hz)	5.0	5.0	ASTM D150
Volume Resistivity (Ohm-meter)	10 ¹¹	10 ¹¹	ASTM D257
Flame Rating	V-O	V-O	U.L. 94
THERMAL AS CURED			
Thermal Conductivity (W/m-K)	1.0	1.0	ASTM D5470
CURE SCHEDULE			
Pot Life @ 25°C (min) (3)	15	15	—
Cure @ 25°C (min) (4)	60 - 120	60 - 120	—
Cure @ 100°C (min) (4)	5	5	—

1) Brookfield RV, Heli-Path, Spindle TF @ 20 rpm, 25°C.
2) Thirty second delay value Shore 00 hardness scale.
3) Time for viscosity to double.
4) Cure schedule (rheometer - time to read 90% cure)

GAP PAD

Typical Applications Include:

- Automotive electronics
- Computer and peripherals
- Between any heat-generating semiconductor and a heat sink
- Telecommunications
- Thermally conductive vibration dampening

Configurations Available:

- For smaller quantity packaging, please contact Bergquist Sales

Building a Part Number

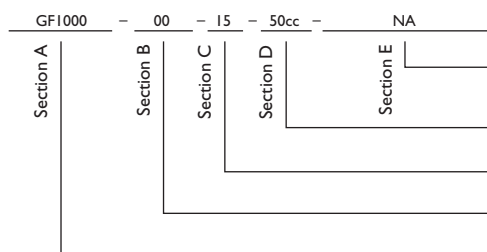

Standard Options

◀ example
NA = Selected standard option. If not selecting a standard option, insert company name, drawing number, and revision level.
Cartridges: 50cc = 50.0cc, 400cc = 400.0cc
Kits: 1200cc = 1200.0cc, or 10G = 10 gallon
Pot Life: 15 = 15 minutes
00 = No spacer beads
07 = 0.007" spacer beads
GF1000 = Gap Filler 1000 Material

Note: To build a part number, visit our website at www.bergquistcompany.com.

Gap Pad®: U.S. Patent 5,679,457 and others.

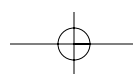

Gap Filler 1100SF (Two-Part)

Thermally Conductive, Silicone-Free, Liquid Gap Filling Material

GAP PAD

Features and Benefits

- Thermal conductivity: 1.1 W/m-K
- No silicone outgassing or extraction
- Ultra-conforming, designed for fragile and low-stress applications
- Ambient and accelerated cure schedules
- 100% solids – no cure by-products

Gap Filler 1100SF is the thermal solution for silicone-sensitive applications. The material is supplied as a two-part component, curing at room or elevated temperatures. The material exhibits “gel-like” properties then cures to a soft, flexible elastomer, helping reduce thermal cycling stresses during operation and virtually eliminating stress during assembly of low-stress applications.

The two components are colored to assist as a mix indicator (1:1 by volume). The mixed system will cure at ambient temperature. Unlike cured thermal pad materials, the liquid approach offers infinite thickness variations with little or no stress during assembly displacement. Gap Filler 1100SF, although exhibiting some natural tack characteristics, is not intended for use in thermal interface applications requiring a mechanical structural bond.

Application

Gap Filler 1100SF can be mixed and dispensed using dual-tube cartridge packs with static mixers and manual or pneumatic gun or high volume mixing and dispensing equipment (application of heat may be used to reduce viscosity).

TEMPERATURE DEPENDENCE OF VISCOSITY		
The viscosity of the Gap Filler 1100SF material is temperature dependent. The table below provides the multiplication factor to obtain viscosity at various temperatures. To obtain the viscosity at a given temperature, look up the multiplication factor at that temperature and multiply the corresponding viscosity at 25°C.		
Temperature °C	Multiplication Factor	
	Part A	Part B
20	1.43	1.57
25	1.00	1.00
35	0.58	0.50
45	0.39	0.30
50	0.32	0.24

Example - Viscosity of Part A @ 45°:

Viscosity of Part A at 25°C is 450,000 cp. The multiplication factor for part A at 45°C is 0.39. Therefore:

$$(450,000) \times (0.39) = 175,500 \text{ cps}$$

TYPICAL PROPERTIES OF GAP FILLER 1100SF			
PROPERTY	IMPERIAL VALUE	METRIC VALUE	TEST METHOD
Color / Part A	Yellow	Yellow	Visual
Color / Part B	Red	Red	Visual
Viscosity as Mixed (cps) (1)	450,000	450,000	ASTM D2196
Density (g/cc)	2.0	2.0	ASTM D792
Mix Ratio	1:1	1:1	—
Shelf Life @ 25°C (months)	6	6	—
PROPERTY AS CURED			
Color	Orange	Orange	Visual
Hardness (Shore 00) (2)	60	60	ASTM D2240
Heat Capacity (J/g-K)	0.9	0.9	ASTM E1269
Continuous Use Temp (°F) / (°C)	-76 to 257	-60 to 125	—
ELECTRICAL AS CURED			
Dielectric Strength (V/mil)	400	400	ASTM D149
Dielectric Constant (1000 Hz)	5.0	5.0	ASTM D150
Volume Resistivity (Ohm-meter)	10 ¹⁰	10 ¹⁰	ASTM D257
Flame Rating	V-O	V-O	U.L. 94
THERMAL AS CURED			
Thermal Conductivity (W/m-K)	1.1	1.1	ASTM D5470
CURE SCHEDULE			
Pot Life @ 25°C (min) (3)	10-15	10-15	—
Cure @ 25°C (hrs) (4)	4	4	—
Cure @ 100°C (min) (4)	45	45	—

1) Brookfield RV, Heli-Path, Spindle TF @ 2 rpm, 25°C.
 2) Thirty second delay value Shore 00 hardness scale.
 3) Time for viscosity to double.
 4) Cure schedule (rheometer - time to read 90% cure)

Typical Applications Include:

- Silicone-sensitive optic components
- Silicone-sensitive electronics
- Filling various gaps between heat-generating devices to heat sinks and housings
- Mechanical switching relay
- Hard disk assemblies
- Dielectric for bare-leaded devices

Configurations Available:

- Supplied in cartridge or kit form

Building a Part Number

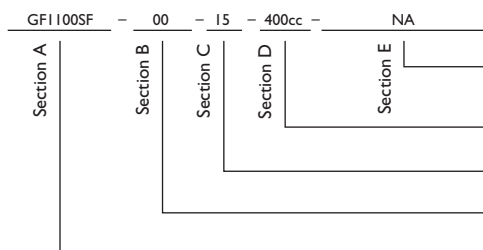

Standard Options

◀ example

NA = Selected standard option. If not selecting a standard option, insert company name, drawing number, and revision level.

Cartridges: 400cc = 400.0cc
 Kits: 1200cc = 1200.0cc, or 10G = 10 gallon

Pot Life: 15 = 15 minutes

00 = No spacer beads
 07 = 0.007" spacer beads

GFI 1100SF = Gap Filler 1100SF Material

Note: To build a part number, visit our website at www.bergquistcompany.com.

Gap Pad®: U.S. Patent 5,679,457 and others.

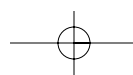

Gap Filler Gel 1500

The first in a new family of highly-conformable gels requiring no curing, mixing or refrigeration

Features and Benefits

- Highly conformable and requires no curing, mixing or refrigeration
- Excellent high and low temperature mechanical and chemical stability
- Storage stability of up to one year without filler settling issues
- Reworkable
- Good thermal performance: 1.4 W/mK
- Stress conforming through low modulus

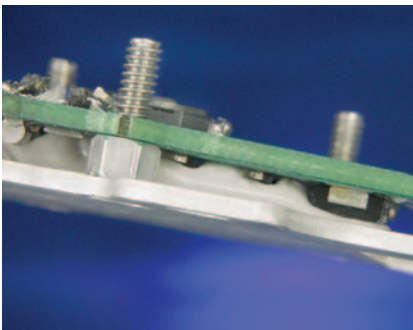
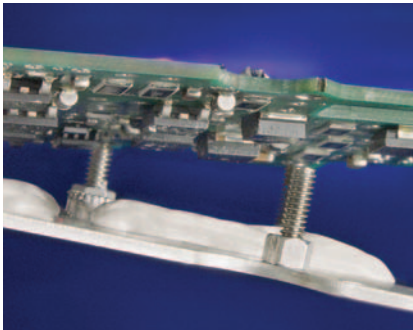

Gap Filler Gel 1500 is the first member in Bergquist's new family of pre-cured gap filling materials. The product is a highly conformable gel which requires no curing, mixing or refrigeration. Its unique formulation assures excellent thermal conductivity, stress conformance through low modulus, excellent high and low temperature chemical storage and storage stability up to one year. Gap Filler Gel 1500 is ideal for thermal interface applications where highly variable gaps and tolerances exist in electronic components, where only minimal stress on components is permissible and rework may be required.

TYPICAL PROPERTIES OF GAP FILLER GEL 1500			
PROPERTY	IMPERIAL VALUE	METRIC VALUE	TEST METHOD
Color	Gray	Gray	Visual
Shear Modulus (Pa) (1)	1000 - 10,000	1000 - 10,000	ASTM D4473
Viscosity (Pa-sec) (2)	200	200	ASTM D5099
Density (g/cc)	1.8	1.8	ASTM D792
Heat Capacity (J/g-K)	1.3	1.3	ASTM E1269
Continuous Use Temp (°F) / (°C)	-76 to 347	-60 to 175	-
Shelf Life at 25°C (months)	12	12	-
ELECTRICAL			
Dielectric Strength (V/mil)	250	250	ASTM D149
Dielectric Constant (1000 Hz)	6	6	ASTM D150
Volume Resistivity (Ohm-meter)	10 ¹¹	10 ¹¹	ASTM D257
Flame Rating	V-O	V-O	UL 94
THERMAL			
Thermal Conductivity (W/m-K)	1.4	1.4	ASTM D5470

1) Parallel plate rheometer at 1 Hz and 0.1% strain.
2) Capillary rheometer at 900 sec⁻¹.

GAP PAD

Typical Applications Include:

- Automotive electronics
- Computer and peripherals
- Between any heat-generating semiconductor and a heat sink
- Telecommunications
- Thermally conductive vibration dampening

Configurations Available:

- 30cc, 310cc and 600cc tubes
- 5-gallon containers
- 7 mil spacer beads

Building a Part Number

GFGel1500 - 00 - NA - 5G - NA

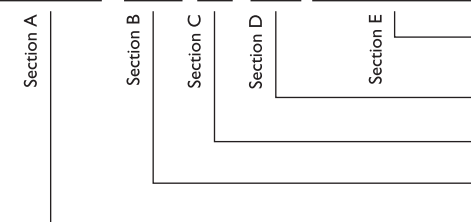

Standard Options

◀ example

NA = Selected standard option. If not selecting a standard option, insert company name, drawing number, and revision level.

Cartridges: 30cc = 30.0cc, 600cc = 600cc
or 5G = 5 gallon

Pot Life: NA

00 = No spacer beads, 07 = 0.007" spacer beads

GFGel1500 = Gap Filler Gel 1500 Material

Note: To build a part number, visit our website at www.bergquistcompany.com.

Gap Pad®: U.S. Patent 5,679,457 and others.

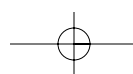

Gap Filler 2000 (Two-Part)

High Thermally Conductive, Liquid Gap Filling Material

Features and Benefits

- Thermal conductivity: 2.0 W/m-K
- Ultra-conforming, designed for fragile and low-stress applications
- Ambient and accelerated cure schedules
- 100% solids – no cure by-products
- Excellent low and high temperature mechanical and chemical stability

GAP PAD

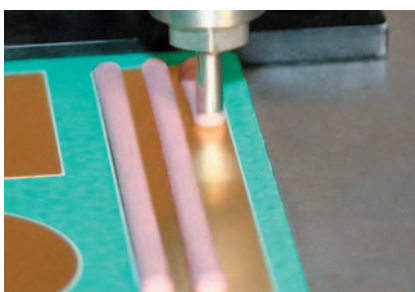

Gap Filler 2000 is a high performance, thermally conductive, liquid gap filling material supplied as a two-component, room or elevated temperature curing system. The material provides a balance of cured material properties and good compression set (memory). The result is a soft, form-in-place elastomer ideal for coupling "hot" electronic components mounted on PC boards with an adjacent metal case or heat sink. Before cure, it flows under pressure like grease. After cure, it won't pump from the interface as a result of thermal cycling and is dry to the touch.

Unlike cured Gap Filling materials, the liquid approach offers infinite thickness with little or no stress during displacement and assembly. It also eliminates the need for specific pad thickness and die-cut shapes for individual applications.

Gap Filler 2000 is intended for use in thermal interface applications when a strong structural bond is not required. Gap Filler 2000 is formulated for low-modulus, "gel-like" properties.

Note: Resultant thickness is defined as the final gap thickness of the application.

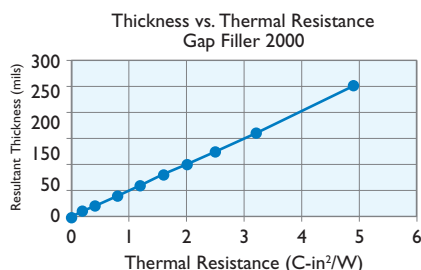

TYPICAL PROPERTIES OF GAP FILLER 2000			
PROPERTY	IMPERIAL VALUE	METRIC VALUE	TEST METHOD
Color / Part A	Pink	Pink	Visual
Color / Part B	White	White	Visual
Viscosity as Mixed (cps) (1)	300,000	300,000	ASTM D2196
Density (g/cc)	2.9	2.9	ASTM D792
Mix Ratio	1:1	1:1	—
Shelf Life @ 25°C (months)	6	6	—
PROPERTY AS CURED			
Color	Pink	Pink	Visual
Hardness (Shore 00) (2)	70	70	ASTM D2240
Heat Capacity (J/g-K)	1.0	1.0	ASTM E1269
Continuous Use Temp (°F) / (°C)	-76 to 392	-60 to 200	—
ELECTRICAL AS CURED			
Dielectric Strength (V/mil)	500	500	ASTM D149
Dielectric Constant (1000 Hz)	7.0	7.0	ASTM D150
Volume Resistivity (Ohm-meter)	10 ¹¹	10 ¹¹	ASTM D257
Flame Rating	V-O	V-O	U.L. 94
THERMAL AS CURED			
Thermal Conductivity (W/m-K)	2.0	2.0	ASTM D5470
CURE SCHEDULE			
Pot Life @ 25°C (min) (3)	15	15	—
Cure @ 25°C (min) (4)	60 - 120	60 - 120	—
Cure @ 100°C (min) (4)	5	5	—

1) Brookfield RV, Heli-Path, Spindle TF @ 20 rpm, 25°C.
 2) Thirty second delay value Shore 00 hardness scale.
 3) Time for viscosity to double.
 4) Cure schedule (rheometer - time to read 90% cure)

Typical Applications Include:

- Automotive electronics
- Computer and peripherals
- Between any heat-generating semiconductor and a heat sink
- Telecommunications
- Thermally conductive vibration dampening

Configurations Available:

- For smaller quantity packaging, please contact Bergquist Sales

Building a Part Number

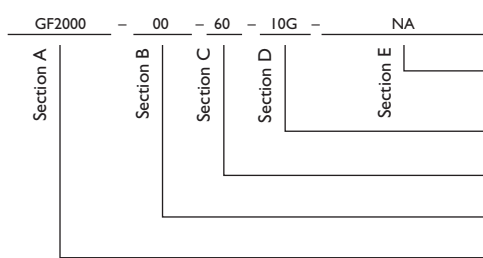

Note: To build a part number, visit our website at www.bergquistcompany.com.

Gap Pad®: U.S. Patent 5,679,457 and others.

Standard Options

NA = Selected standard option. If not selecting a standard option, insert company name, drawing number, and revision level.

Cartridges: 50cc = 50.0cc, 400cc = 400.0cc
 Kits: 1200cc = 1200.0cc, or 10G = 10 gallon

Pot Life: 15 = 15 minutes, 60 = 60 minutes

00 = No spacer beads
 07 = 0.007" spacer beads

GF2000 = Gap Filler 2000 Material

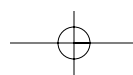

Gap Filler 3500S35 (Two-Part)

Thermally Conductive Liquid Gap Filling Material

Features and Benefits

- Thermal Conductivity: 3.6 W/m-K
- Thixotropic nature makes it easy to dispense
- Two-part formulation for easy storage
- Ultra-conforming - designed for fragile and low stress applications
- Ambient or accelerated cure schedules

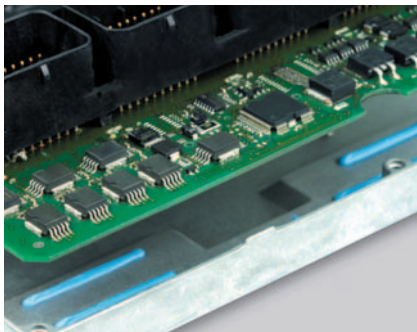

Gap Filler 3500S35 is the technology leader in thermally conductive, liquid gap filling materials, featuring ultra-high thermal performance and superior softness. The material is two-component, cured either at room or elevated temperature. Prior to curing, the material maintains good thixotropic characteristics as well as low viscosity. The result is a gel-like liquid material designed to fill air gaps and voids yet flow when acted upon by an external force (e.g. dispensing or assembly process). The material is an excellent solution for interfacing fragile components with high topography and/or stack-up tolerances to a universal heat sink or housing. Once cured, it remains a low modulus elastomer designed to assist in relieving CTE stresses during thermal cycling yet maintain enough modulus to prevent pump-out from the interface. Gap Filler 3500S35 will lightly adhere to surfaces, thus improving surface area contact. Gap Filler 3500S35 is not designed to be a structural adhesive.

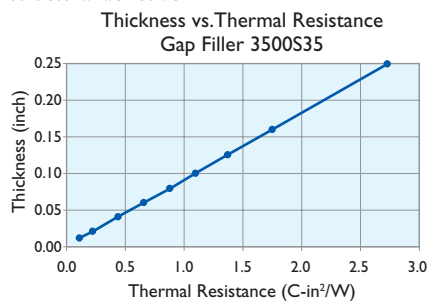

TYPICAL PROPERTIES OF GAP FILLER 3500S35			
PROPERTY	IMPERIAL VALUE	METRIC VALUE	TEST METHOD
Color / Part A	White	White	Visual
Color / Part B	Blue	Blue	Visual
Viscosity as Mixed (cps) (1)	150,000	150,000	ASTM D2196
Density (g/cc)	1.0	1.0	ASTM D792
Mix Ratio	1:1	1:1	—
Shelf Life @ 25°C (months)	5	5	—
PROPERTY AS CURED			
Color	Blue	Blue	Visual
Hardness (Shore 00) (2)	32	32	ASTM D2240
Continuous Use Temp (°F) / (°C)	-76 to 392	-60 to 200	—
ELECTRICAL AS CURED			
Dielectric Strength (V/mil)	275	275	ASTM D149
Dielectric Constant (1000 Hz)	8.0	8.0	ASTM D150
Volume Resistivity (Ohm-meter)	10 ⁹	10 ⁹	ASTM D257
Flame Rating	V-O	V-O	UL 94
THERMAL AS CURED			
Thermal Conductivity (W/m-K)	3.6	3.6	ASTM D5470
CURE SCHEDULE			
Pot Life @ 25°C (min) (3)	60	60	—
Cure @ 25°C (min) (4)	15	15	—
Cure @ 100°C (min) (4)	30	30	—
1) Brookfield RV, Heli-Path, Spindle TF @ 20 rpm, 25°C. 2) Thirty second delay value Shore 00 hardness scale. 3) Time for viscosity to double. 4) Cure schedule (rheometer - time to read 90% cure)			

GAP PAD

Typical Applications Include:

- Automotive electronics
- Discrete components to housing
- PCBA to housing
- Fiber optic telecommunications equipment

Configurations Available:

- Supplied in cartridge or kit form

Building a Part Number

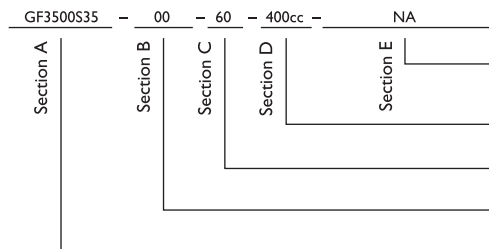

Standard Options

NA = Selected standard option. If not selecting a standard option, insert company name, drawing number, and revision level.

Cartridges: 50cc = 50.0cc, 400cc = 400.0cc
 Kits: 1200cc = 1200.0cc, or 10G = 10 gallon

Pot Life: 60 = 60 minutes

00 = No spacer beads
 07 = 0.007" spacer beads

GF3500S35 = Gap Filler 3500S35 Material

Note: To build a part number, visit our website at www.bergquistcompany.com.

Gap Pad®: U.S. Patent 5,679,457 and others.

TIC™ - Thermal Interface Compound

Thermally Conductive Grease Compounds

Bergquist's line of thermally conductive thermal interface compounds will flow under assembly pressure to wet-out the thermal interface surfaces and produce very low thermal impedance. TIC products are

designed for use between a high-end computer processor and a heat sink or other high watt density applications.

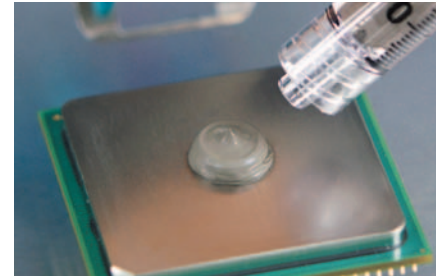
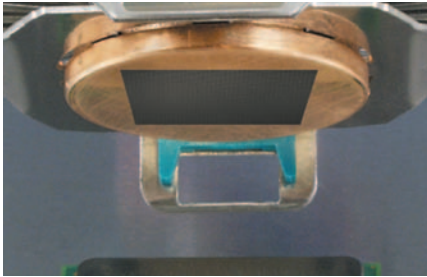

TIC

Features

The TIC portfolio has diverse thermal and electrical characteristics. Key criteria when selecting TIC products include:

- Viscosity
- Volume resistivity
- Thermal conductivity
- Thermal performance
- Filler size

Benefits

TIC products are ideal for high watt density applications. Primary benefits include:

- Low interfacial resistance
- Low thermal impedance
- Resists dripping
- Ideally suited to screen printing applications
- No post "cure" conditioning required

Options

TIC products can be obtained with application-specific options such as:

- Containers

Applications

TIC has a variety of applications such as:

- CPU
- GPU
- IGBT
- High power density applications

Comparison Data and FAQ's

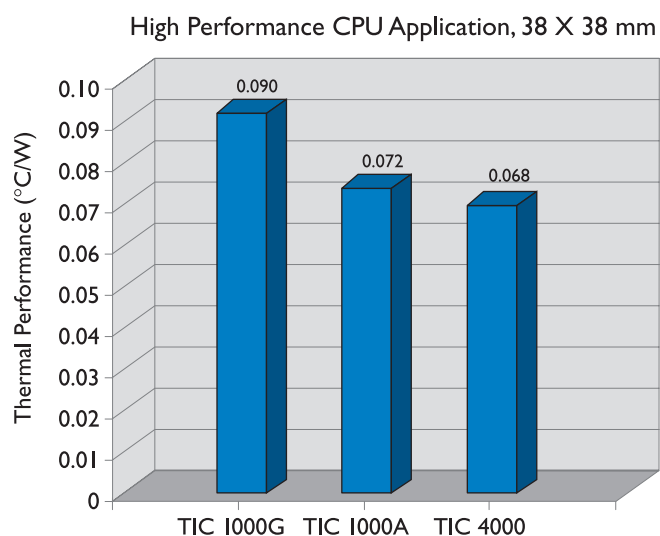

Q: What is the best fastening method for a TIC interface?

A: A constant-pressure fastener is preferred when using TIC for high performance applications. The constant pressure from a clip or spring washer will ensure adequate pressure is being applied with varying bond line thickness.

Q: How should the TIC be applied?

A: Screenprinting the TIC is a fast, low-cost method that delivers a consistent and accurate amount of material on each application. Alternate methods include stenciling, pin transfer and needle dispensing.

Q: Will the grease stay in the interface?

A: All the TIC materials were specifically designed to resist pump-out of the interface, even after many hours of thermal and power cycling.

TIC™ 1000G

High Performance, Value Compound for High-End Computer Processors

Features and Benefits

- Thermal performance: 0.29°C/W (@ 50 psi)
- Excellent screenability
- No post "cure" required
- Cost vs. performance leader

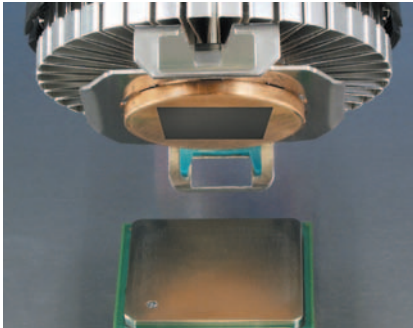

TIC 1000G is a high performance, thermally conductive compound intended for use as a thermal interface material between a high-end computer processor and a heat sink. Other high watt density applications will benefit from the extremely low thermal impedance of TIC 1000G.

TIC 1000G compound wets-out the thermal interface surfaces and flows to produce the lowest thermal impedance. The compound requires pressure of the assembly to cause flow. The compound will resist dripping.

For microprocessor applications, traditional screw fastening or spring clamping methods will provide adequate force to optimize the thermal performance of TIC 1000G.

An optimized application would utilize the minimum volume of TIC 1000G compound necessary to ensure complete wet-out of both mechanical interfaces.

Note: TIC 1000G is ideally suited for screen-printing applications. Please contact Bergquist Sales for application notes related to screen-printing.

Assembly – No Post Screen Cure

TIC 1000G has excellent screenability. No solvent is used to reduce the viscosity, so no post "cure" conditioning is required.

TYPICAL PROPERTIES OF TIC 1000G						
PROPERTY	IMPERIAL VALUE	METRIC VALUE	TEST METHOD			
Color	Black	Black	Visual			
Density (g/cc)	1.2	1.2	ASTM D792			
Continuous Use Temp (°F) / (°C)	302	150	—			
ELECTRICAL						
Electrical Resistivity (Ohm-meter) (1)	N/A	N/A	ASTM D257			
THERMAL						
Thermal Conductivity (W/m-K)	0.7	0.7	ASTM D5470			
THERMAL PERFORMANCE vs PRESSURE						
	Pressure (psi)	10	25	50	100	200
	TO-220 Thermal Performance (°C/W) (2)	0.32	0.30	0.29	0.27	0.26

1) The compound contains an electrically conductive filler surrounded by electrically non-conductive resin.
2) TO-220 performance data is provided as a reference to compare material thermal performance.

Application Cleanliness

Pre-clean heat sink and component interface with isopropyl alcohol prior to assembly or repair. Be sure heat sink is dry before applying TIC 1000G.

Application Methods

1. Dispense and/or screenprint TIC 1000G compound onto the processor or heat sink surface like thermal grease (see a Bergquist Representative for application information).
2. Assemble the processor and heat sink with spring clips or constant-pressure fasteners.

Typical Applications Include:

- High performance CPU's
- High performance GPU's

Building a Part Number

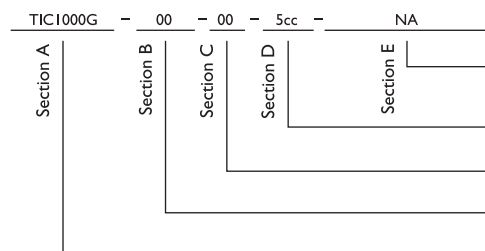

Note: To build a part number, visit our website at www.bergquistcompany.com.

TIC™: U.S. Patents 6,797,758; 6,624,224; 6,339,120.

Standard Options

◀ example

NA = Selected standard option. If not selecting a standard option, insert company name, drawing number, and revision level.

Containers: 5cc = 5.0cc, 25cc = 25.0cc, 200cc = 200.0cc, 800cc = 800.0cc, 1600cc = 1600.0cc

00 = No options

00 = No options

TIC1000G = Thermal Interface Compound 1000G

TIC™ 1000A

High Performance, Value Compound for High-End Computer Processors

Features and Benefits

- High thermal performance: 0.32°C/W (@ 50 psi)
- Good screenability
- Room temperature storage
- No post “cure” required
- Exceptional value

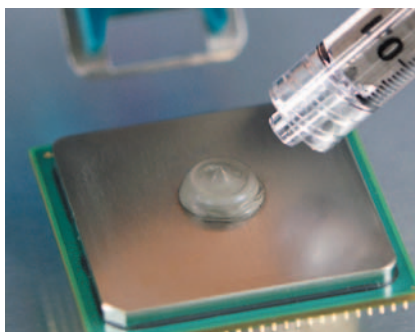

TIC

TIC 1000A is a high performance, thermally conductive compound intended for use as a thermal interface material between a high-end computer processor and a heat sink. Other high watt density applications will also benefit from the extremely low thermal impedance of TIC 1000A.

TIC 1000A compound wets-out the thermal interface surfaces and flows to produce the lowest thermal impedance. The compound requires pressure of the assembly to cause flow. The TIC 1000A compound will resist dripping.

For microprocessor applications, traditional screw fastening or spring clamping methods will provide adequate force to optimize the thermal performance of TIC 1000A.

An optimized application would utilize the minimum volume of TIC 1000A material necessary to ensure complete wet-out of both mechanical interfaces.

Assembly – No Post Screen Cure

TIC 1000A has good screenability. No solvent is used to reduce the viscosity, so no post “cure” conditioning is required.

TYPICAL PROPERTIES OF TIC 1000A

PROPERTY	IMPERIAL VALUE	METRIC VALUE	TEST METHOD			
Color	Gray	Gray	Visual			
Density (g/cc)	2.1	2.1	ASTM D792			
Continuous Use Temp (°F) / (°C)	302	150	—			
ELECTRICAL						
Electrical Resistivity (Ohm-meter) (1)	N/A	N/A	ASTM D257			
THERMAL						
Thermal Conductivity (W/m-K)	1.5	1.5	ASTM D5470			
THERMAL PERFORMANCE vs PRESSURE						
	Pressure (psi)	10	25	50	100	200
	TO-220 Thermal Performance (°C/W) (2)	0.32	0.32	0.32	0.31	0.28

1) The compound contains an electrically conductive filler surrounded by electrically non-conductive resin.
2) TO-220 performance data is provided as a reference to compare material thermal performance.

Application Cleanliness

1. Pre-clean heat sink and component interface with isopropyl alcohol prior to assembly or repair. Ensure heat sink is dry before applying TIC 1000A.

Application Methods

1. Dispense and/or screenprint TIC 1000A compound onto the processor or heat sink surface like thermal grease (see a Bergquist Representative for application information).
2. Assemble the processor and heat sink with spring clips or constant-pressure fasteners.

Typical Applications Include:

- High performance CPUs
- High performance GPUs

Building a Part Number

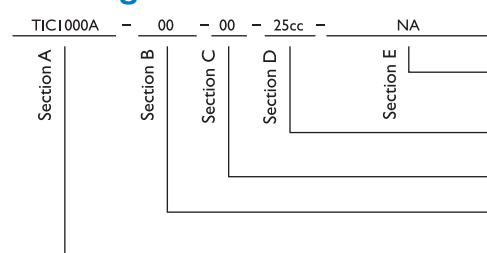

Standard Options

◀ example

NA = Selected standard option. If not selecting a standard option, insert company name, drawing number, and revision level.

Containers: 5cc = 5.0cc, 25cc = 25.0cc, 200cc = 200.0cc, 800cc = 800.0cc, 1600cc = 1600.0cc

00 = No options

00 = No options

TIC1000A = Thermal Interface Compound 1000A

Note: To build a part number, visit our website at www.bergquistcompany.com.

TIC™: U.S. Patents 6,797,758; 6,624,224; 6,339,120.

TIC™ 4000

High Performance Thermal Interface Compound for Copper-Based Heat Sinks

Features and Benefits

- Thermal conductivity: 4.0 W/m-K
- Exceptional thermal performance: 0.19°C/W @ 50 psi

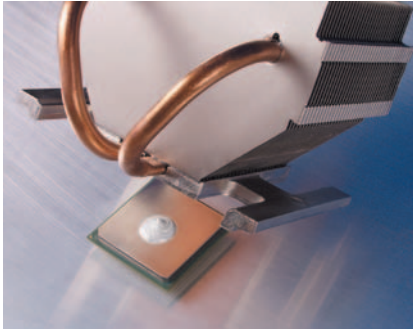

TIC 4000 is a thermally conductive grease compound designed for use as a thermal interface material between a computer processor and a copper-based heat sink. Other high watt density applications will benefit from the extremely low thermal impedance of TIC 4000.

TIC 4000 compound wets-out the thermal interface surfaces and flows to produce low thermal impedance. The compound requires pressure of the assembly to cause flow. TIC 4000 compound will not drip.

For a typical 0.5" x 0.5" application at 0.005" thick, Bergquist estimates approximately 0.02 ml (cc) of TIC 4000.

Although Bergquist estimates a 0.02 ml (cc) volumetric requirement for a 0.5" x 0.5" component interface, dispensed at a thickness of 0.005", Bergquist also recognizes that an optimized application would utilize the minimum volume of TIC 4000 material necessary to ensure complete wet-out of both mechanical interfaces.

TYPICAL PROPERTIES OF TIC 4000						
PROPERTY	IMPERIAL VALUE	METRIC VALUE	TEST METHOD			
Color	Gray	Gray	Visual			
Density (g/cc)	4.0	4.0	ASTM D792			
Continuous Use Temp (°F) / (°C)	302	150	—			
ELECTRICAL						
Electrical Resistivity (Ohm-meter) (1)	N/A	N/A	ASTM D257			
THERMAL						
Thermal Conductivity (W/m-K)	4.0	4.0	ASTM D5470			
THERMAL PERFORMANCE vs PRESSURE						
	Pressure (psi)	10	25	50	100	200
	TO-220 Thermal Performance (°C/W) (2)	0.21	0.20	0.19	0.19	0.18

1) The compound contains an electrically conductive filler surrounded by electrically non-conductive resin.
2) TO-220 performance data is provided as a reference to compare material thermal performance.

Application Methods

1. Pre-clean heat sink and component interface with isopropyl alcohol prior to assembly or repair. Ensure heat sink is dry before applying TIC 4000.
2. Dispense TIC 4000 compound onto the processor or heat sink surface like thermal grease.
3. Assemble the processor and heat sink with clip or constant-pressure fasteners.

Typical Applications Include:

- High performance computer processors (traditional screw fastening or clamping methods will provide adequate force to optimize the thermal performance of TIC 4000)
- High watt density applications where the lowest thermal resistance interface is required

Building a Part Number

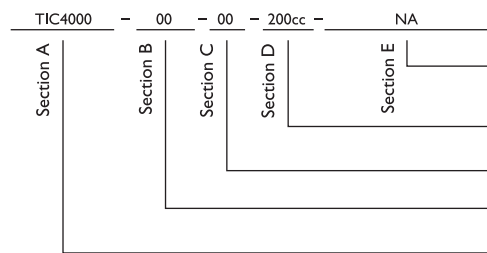

Standard Options

◀ example
 NA = Selected standard option. If not selecting a standard option, insert company name, drawing number, and revision level.
 Containers: 5cc = 5.0cc, 25cc = 25.0cc, 200cc = 200.0cc, 800cc = 800.0cc, 1600cc = 1600.0cc
 00 = No options
 00 = No options
 TIC4000 = Thermal Interface Compound 4000

Note: To build a part number, visit our website at www.bergquistcompany.com.

TIC™: U.S. Patents 6,797,758; 6,624,224; 6,339,120.

TIC

Hi-Flow[®] Phase Change Interface Materials

Solutions-Driven Thermal Management Products for Electronic Devices

Use phase change materials for excellent thermal performance without the mess of grease.

Hi-Flow phase change materials are an excellent replacement for grease as a thermal interface between a CPU or power device and a heat sink. The materials change from a solid at specific phase change temperatures and flow to assure a total wet-out of the interface without overflow. The result is a thermal interface comparable to grease, without the mess, contamination and hassle.

The Hi-Flow family of phase change thermal interface materials covers a wide range of applications. The Bergquist Company is a leader in thermal management solutions and works closely with customers to ensure that the proper Hi-Flow material is specified.

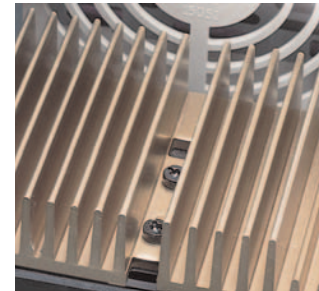
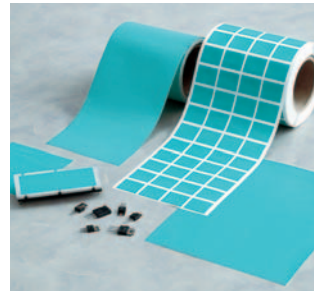
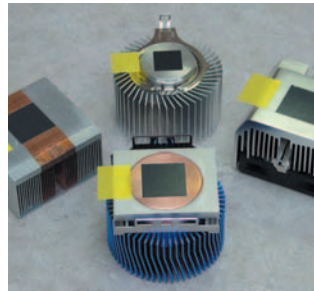
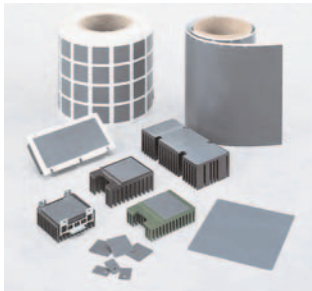

Features

Hi-Flow handles like Bergquist's famed Sil-Pad materials at room temperature, but flows like grease at its designed phase change temperature. The following is an overview of the important features shared by the Hi-Flow family:

- Comparable thermal performance to grease in most applications
- Thermally conductive phase change compound
- Aluminum, film or fiberglass carriers and non-reinforced versions
- Low volatility
- Easy to handle and apply in the manufacturing environment
- Tackified or tack-free at room temperature

Benefits

Using Hi-Flow materials instead of grease can save time and money without sacrificing thermal performance. Here are some other benefits:

- No mess – thixotropic characteristics of the materials keep it from flowing out of the interface
- Easier handling – tackified or tack-free at room temperature
- Does not require protective liner
- High thermal performance helps ensure CPU reliability
- Does not attract contaminants
- Easier material handling and shipping
- Simplified application process

Options

The broad Hi-Flow family offers a variety of choices to meet the customer's performance, handling and process needs. Some of the choices include:

- Some Hi-Flows are available with or without adhesive
- Aluminum carrier for applications not requiring electrical isolation
- Film or fiberglass carrier for electrical isolation
- Dry, non-reinforced material
- Tackified or tack-free at room temperature
- Tabbed parts, die-cut parts, sheets or bulk rolls
- Adhesive specifically for cold application without preheating heat sink

We produce thousands of specials. Tooling charges vary depending on the complexity of the part.

Applications

Hi-Flow materials are suited for consumer and industrial electronics, automotive, medical, aerospace and telecommunications applications such as:

- UPS and SMPS AC/DC, DC/DC or linear power supplies
- Between a CPU and heat sink
- Power conversion devices
- Fractional and integral motor control
- Leaded, surface mount and power module assemblies

HI-FLOW

U.S. Patent 5,679,457 and others.

Hi-Flow[®] Comparison Data

TO-220 Thermal Performance

Isolating Hi-Flow Series 300 to 625 Grease Replacement Materials

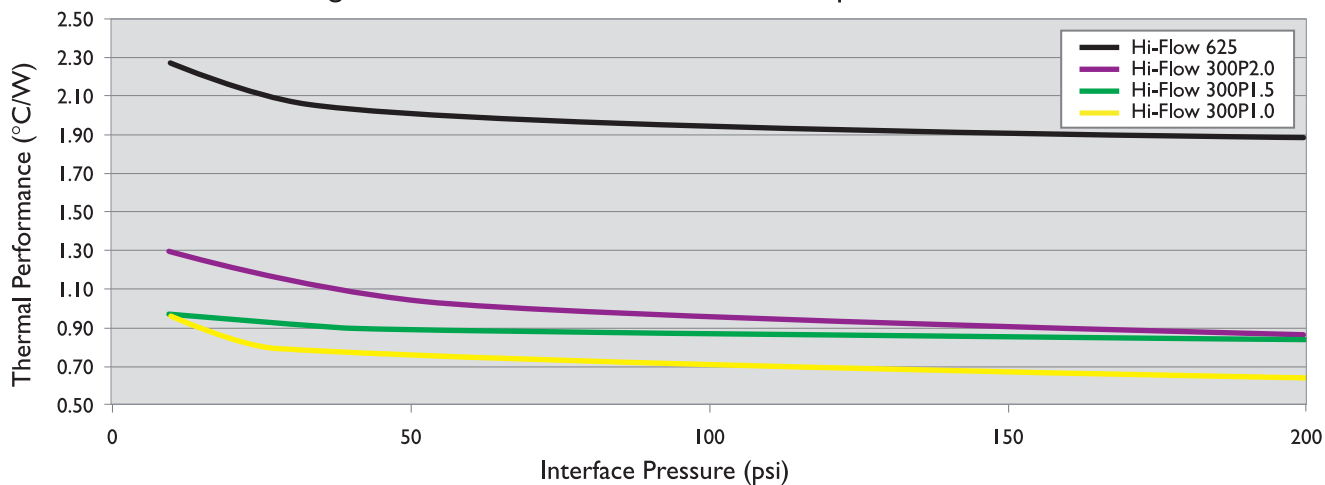

Non-Isolating Hi-Flow Series 105 to 300 Grease Replacement Materials

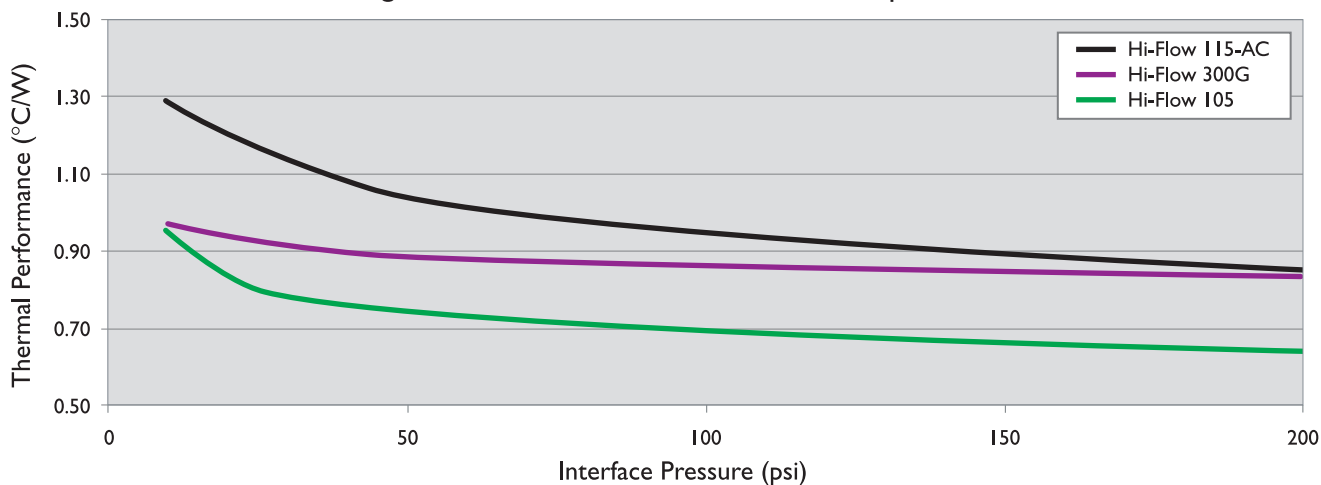

Non-Isolating Hi-Flow 225 Grease Replacement Materials

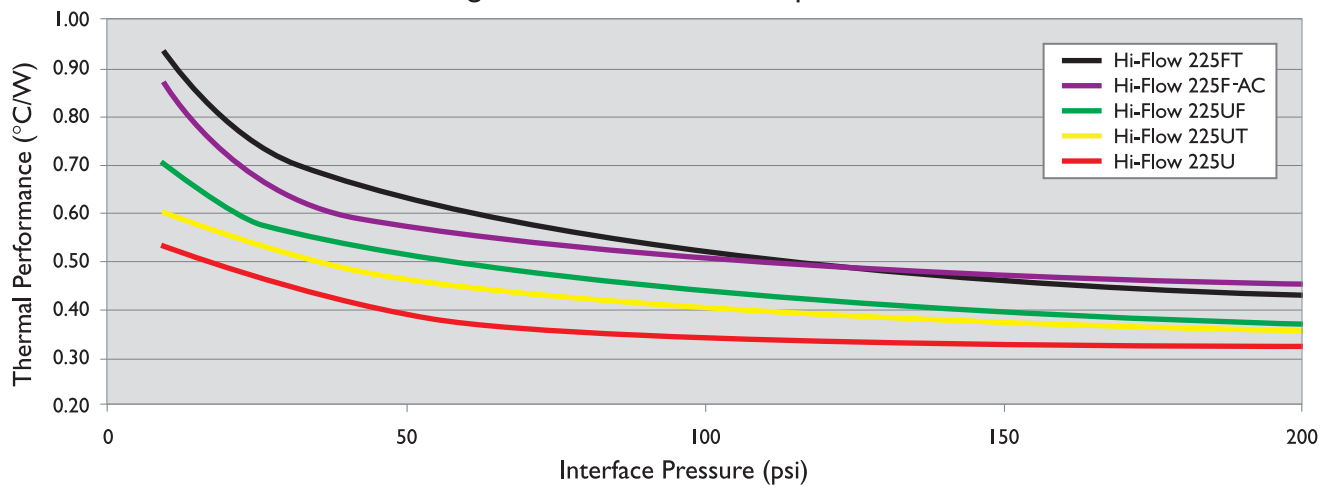

HI-FLOW

Frequently Asked Questions

Q: How is the ASTM D5470 test modified to characterize phase change thermal performance?

A: ASTM classifies a phase change as a Type I, viscous liquid that exhibits unlimited deformation when a stress is applied. Bergquist utilizes test equipment that is designed to meet ASTM D5470 specifications for Type I, which requires a shim or mechanical stop to precisely control the thickness. The phase change material is conditioned at 5°C over the stated phase change temperature. Understanding that time is also a key variable for material flow, the over-temperature condition is limited to 10 minutes and then allowed to cool, prior to initiating the actual test at the given pressure. The 10 minute time has been demonstrated to be an acceptable time period for the thermal mass inherent in the test setup. **Note:** Actual application testing may require more or less time to condition, depending upon the heat transfer and associated thermal mass. The performance values are recorded and published at 10, 25, 50, 100 and 200 psi to give the designer a broad-based understanding of Hi-Flow's performance.

Q: What is the minimum pressure required to optimize the thermal performance of the Hi-Flow material?

A: Upon achieving phase change temperature (e.g. pre-conditioning), Bergquist has demonstrated that 10 psi provides adequate pressure to achieve exceptional thermal performance. Bergquist continues to research lower pressure wet-out characteristics in an effort to minimize interfacial losses associated with ultra-thin material interfaces.

Q: Will the Hi-Flow replace a mechanical fastener?

A: Mechanical fasteners are required. Bergquist recommends the use of spring clips to maintain consistent pressure over time.

Q: Can I use screw-mount devices with Hi-Flow material?

A: Hi-Flow works best with a clip or spring washer-mounted assembly. The continuous force applied by these devices allows the Hi-Flow material to flow and reduce the cross sectional gap. Bergquist suggests that design engineers evaluate whether a screw-mount assembly will have acceptable performance. See TO-220 Technical Note.

Q: Is the adhesive in Hi-Flow 225F-AC repositionable?

A: The adhesive in the current construction does adhere more to the heat sink aluminum than to the Hi-Flow material. There is the potential that the adhesive will be removed by the heat sink surface when it is removed to reposition on the heat sink. Time and/or pressure will increase the bond to the aluminum increasing the potential for the adhesive to adhere to the heat sink.

Q: Is there any surface preparation required before applying the adhesive-backed Hi-Flow to the heat sink?

A: Standard electronics industry cleaning procedures apply. Remove dirt or other debris. Best results are attained when the Hi-Flow material is applied to a heat sink at a temperature of 25° +/- 10°C. If the heat sink has been surface treated (e.g. anodized or chromated), it is typically ready for assembly. For bare aluminum, mild soap and water wash cleaning processes are typically used to eliminate machine oils and debris.

Q: Is Hi-Flow material reworkable?

A: If the material has not gone through phase change, the material will readily release from the device surface. For this situation, the Hi-Flow material will not likely have to be replaced.

If the material has gone through the phase change, it will adhere very well to both surfaces. In this case, Bergquist suggests warming the heat sink to soften the Hi-Flow compound for easier removal from the processor. Replace with a new piece of Hi-Flow material.

Q: What is meant by “easy to handle” in manufacturing?

A: Insulated Hi-Flow products are manufactured with inner film support. This film stiffens the material, allowing parts to be more readily die-cut as well as making the material easier to handle in manual or automated assembly.

Q: What is meant by “tack free” and why is this important?

A: Many Hi-Flow materials have no surface tack at room temperature. The softer materials will pick up dirt more readily. Softer resins are more difficult to clean if any dirt is on the surface. If you try to rub the dirt away, the dirt is easily pushed into the soft phase change materials. Hi-Flow coatings are typically hard at room temperature rendering them easier to clean off without embedding dirt.

Q: What does “more scratch resistance” mean on Hi-Flow 625?

A: Hi-Flow 625 does not require a protective film during shipment. There are two issues with competitors' materials:

- 1) Melt point of the material is low enough that it can go through phase change in shipment and be very tacky. Hi-Flow has a higher phase change temperature and remains hard to a higher temperature.
- 2) The Hi-Flow material is harder and is not as easy to scratch or dent in shipping and handling.

Q: Why is Hi-Flow phase change temperature 65°C?

A: The 65°C phase change temperature was selected for two reasons. First, it was a low enough temperature for the phase change to occur in applications. Second, it would not phase change in transport. Bergquist studies show that shipping containers can reach 60°C in domestic and international shipments. The higher phase change temperature eliminates the possibility of a product being ruined in shipment. We offer a standard line of Hi-Flow 225 and 300 series products with 55°C phase change for those customers wanting the lower phase change temperature.

Q: In which applications should I avoid using Hi-Flow?

A: Avoid using Hi-Flow in applications in which the device will not reach operation at or above phase change temperature. Also avoid applications in which the operating temperature exceeds the maximum recommended operating temperature of the compound.

Hi-Flow® I05

Phase Change Coated Aluminum

Features and Benefits

- Thermal impedance: 0.37°C-in²/W (@25 psi)
- Used where electrical isolation is not required
- Low volatility – less than 1%
- Easy to handle in the manufacturing environment
- Flows but doesn't run like grease

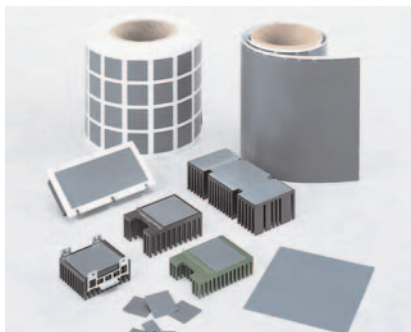

Hi-Flow I05 is a phase change material coated on both sides of an aluminum substrate. It is designed specifically to replace grease as a thermal interface, eliminating the mess, contamination and difficult handling associated with grease. Hi-Flow I05 is tack-free and scratch resistant at room temperature and does not require a protective liner in shipment when attached to a heat sink.

At 65°C (phase change temperature), Hi-Flow I05 changes from a solid and flows, thereby assuring total wet-out of the interface. The thixotropic characteristics of Hi-Flow I05 reduce the pump-out from the interface.

Hi-Flow I05 has thermal performance equal to grease with 0.10°C-in²/W contact thermal resistance.

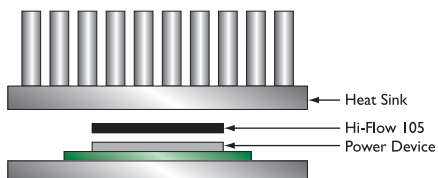

TYPICAL PROPERTIES OF HI-FLOW I05						
PROPERTY	IMPERIAL VALUE	METRIC VALUE	TEST METHOD			
Color	Dark Gray	Dark Gray	Visual			
Reinforcement Carrier	Aluminum	Aluminum	—			
Thickness (inch) / (mm)	0.0055	0.139	ASTM D374			
Continuous Use Temp (°F) / (°C)	266	130	—			
Phase Change Temp (°F) / (°C)	149	65	ASTM D3418			
ELECTRICAL						
Dielectric Constant (1000 (Hz))	3.2	3.2	ASTM D150			
Flame Rating	V-O	V-O	UL 94			
THERMAL						
Thermal Conductivity (W/m-K) (1)	0.9	0.9	ASTM D5470			
THERMAL PERFORMANCE vs PRESSURE						
	Pressure (psi)	10	25	50	100	200
	TO-220 Thermal Performance (°C/W)	0.95	0.80	0.74	0.69	0.64
	Thermal Impedance (°C-in ² /W) (2)	0.39	0.37	0.36	0.33	0.30

1) This is the measured thermal conductivity of the Hi-Flow coating. It represents one conducting layer in a three-layer laminate. The Hi-Flow coatings are phase change compounds. These layers will respond to heat and pressure induced stresses. The overall conductivity of the material in post-phase change, thin film products is highly dependent upon the heat and pressure applied. This characteristic is not accounted for in ASTM D5470. Please contact Bergquist Product Management if additional specifications are required.
 2) The ASTM D5470 test fixture was used and the test sample was conditioned at 70°C prior to test. The recorded value includes interfacial thermal resistance. These values are provided for reference only. Actual application performance is directly related to the surface roughness, flatness and pressure applied.

Typical Applications Include:

- Power semiconductors
- Microprocessors mounted on a heat sink
- Power conversion modules
- Spring or clip mount applications where thermal grease is used

Configurations Available:

- Sheet form, die-cut parts and roll form
- With or without pressure sensitive adhesive

Building a Part Number

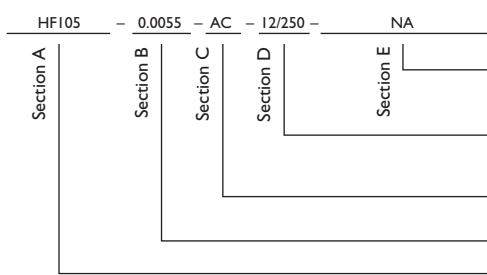

Standard Options

NA = Selected standard option. If not selecting a standard option, insert company name, drawing number, and revision level.
 1212 = Standard configuration dash number, 1212 = 12" x 12" sheets, 12/250 = 12" x 250' rolls, or 00 = custom configuration
 AC = Adhesive, one side
 00 = No adhesive
 Standard thicknesses available: 0.0055"
 HF105 = Hi-Flow I05 Phase Change Material

Note: To build a part number, visit our website at www.bergquistcompany.com.

Hi-Flow®: U.S. Patents 6,197,859 and 5,950,066.

HI-FLOW

Hi-Flow® I15-AC

Fiberglass-Reinforced, Phase Change Thermal Interface Material

Features and Benefits

- Thermal impedance: 0.37°C-in²/W (@25 psi)
- Can be applied directly to a cold heat sink
- One side adhesive-coated to aid in positioning
- Fiberglass reinforced

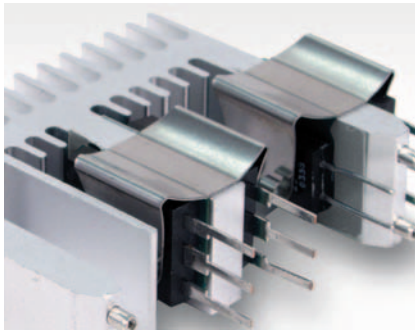

Bergquist Hi-Flow I15-AC is a thermally conductive fiber reinforced phase change material. The product consists of a thermally conductive 65°C phase change compound coated on a fiberglass web, and an adhesive coating on one side for attachment to a cold heat sink. There is no need to preheat the heat sink to apply the Hi-Flow I15-AC.

Hi-Flow I15-AC is designed as a thermal interface material between a computer processor and a heat sink. The pressure sensitive adhesive makes it simple to apply in high volume to heat sinks and the 65°C phase change temperature eliminates shipping and handling problems.

Hi-Flow I15-AC requires no protective liner for shipping or handling. The Hi-Flow coating has excellent handling characteristics at room temperature, and can withstand the handling and shipping process without protection.

Hi-Flow I15-AC handles like a Sil-Pad at room temperature and flows like high-quality grease at elevated temperatures.

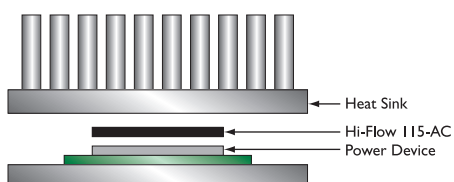

TYPICAL PROPERTIES OF HI-FLOW I15-AC						
PROPERTY	IMPERIAL VALUE	METRIC VALUE	TEST METHOD			
Color	Gray	Gray	Visual			
Reinforcement Carrier	Fiberglass	Fiberglass	—			
Thickness (inch) / (mm)	0.0055	0.139	ASTM D374			
Elongation (%45° to Warp and Fill)	40	40	ASTM D882A			
Tensile Strength (psi) / (MPa)	900	6	ASTM D882A			
Continuous Use Temp (°F) / (°C)	302	150	—			
Phase Change Temp (°F) / (°C)	149	65	ASTM D3418			
ELECTRICAL						
Dielectric Breakdown Voltage (Vac)	300	300	ASTM D149			
Dielectric Constant (1000 Hz)	3.5	3.5	ASTM D150			
Volume Resistivity (Ohm-meter)	10 ¹⁰	10 ¹⁰	ASTM D257			
Flame Rating	V-O	V-O	U.L. 94			
THERMAL						
Thermal Conductivity (W/m-K) (1)	0.8	0.8	ASTM D5470			
THERMAL PERFORMANCE vs PRESSURE						
	Pressure (psi)	10	25	50	100	200
TO-220 Thermal Performance (°C/W)		1.28	1.16	1.04	0.94	0.85
Thermal Impedance (°C-in ² /W) (2)		0.44	0.37	0.35	0.27	0.15
<small>1) This is the measured thermal conductivity of the Hi-Flow coating. It represents one conducting layer in a three-layer laminate. The Hi-Flow coatings are phase change compounds. These layers will respond to heat and pressure induced stresses. The overall conductivity of the material in post-phase change, thin film products is highly dependent upon the heat and pressure applied. This characteristic is not accounted for in ASTM D5470. Please contact Bergquist Product Management if additional specifications are required. 2) The ASTM D5470 test fixture was used and the test sample was conditioned at 70°C prior to test. The recorded value includes interfacial thermal resistance. These values are provided for reference only. Actual application performance is directly related to the surface roughness, flatness and pressure applied.</small>						

HI-FLOW

Typical Applications Include:

- Computer and peripherals
- As a thermal interface where bare die is exposed and needs to be heat sinked

Configurations Available:

- Sheet form, die-cut parts and roll form
- With pressure sensitive adhesive

Building a Part Number

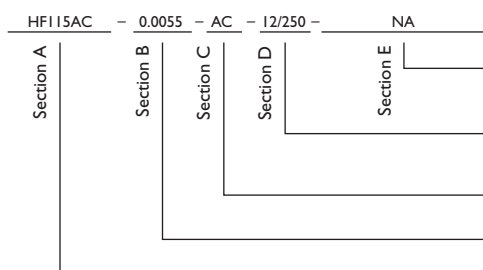

Standard Options

◀ example

NA = Selected standard option. If not selecting a standard option, insert company name, drawing number, and revision level.

— — — = Standard configuration dash number,
 1212 = 12" x 12" sheets, 12/250 = 12" x 250' rolls, or
 00 = custom configuration

AC = Adhesive, one side
 00 = No adhesive

Standard thicknesses available: 0.0055"

HF115AC = Hi-Flow I15-AC Phase Change Material

Note: To build a part number, visit our website at www.bergquistcompany.com.

Hi-Flow®: U.S. Patents 6,197,859 and 5,950,066.

Hi-Flow® 225F-AC

Reinforced, Phase Change Thermal Interface Material

Features and Benefits

- Thermal impedance: 0.10°C-in²/W (@25 psi)
- Can be manually or automatically applied to the surfaces of room-temperature heat sinks
- Foil reinforced, adhesive-coated
- Soft, thermally conductive 55°C phase change compound

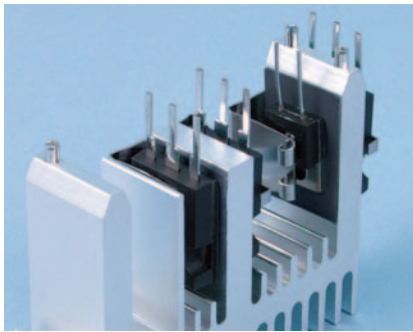

Hi-Flow 225F-AC is a high performance, thermal interface material for use between a computer processor and a heat sink. Hi-Flow 225F-AC consists of a soft, thermally conductive 55°C phase change compound coated to the top surface of an aluminum carrier with a soft, thermally conductive adhesive compound coated to the bottom surface to improve adhesion to the heat sink.

Above the 55°C phase change temperature, Hi-Flow 225F-AC wets-out the thermal interface surfaces and flows to produce low thermal impedance.

Hi-Flow 225F-AC requires pressure from the assembly to cause material flow. The Hi-Flow coatings resist dripping in vertical orientation.

The material includes a base carrier liner with differential release properties to facilitate simplicity in roll form packaging and application assembly. Please contact Bergquist Product Management for applications that are less than 0.07" square.

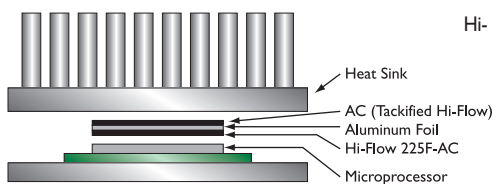

TYPICAL PROPERTIES OF HI-FLOW 225F-AC						
PROPERTY	IMPERIAL VALUE	METRIC VALUE	TEST METHOD			
Color	Black	Black	Visual			
Reinforcement Carrier	Aluminum	Aluminum	—			
Thickness (inch) / (mm)	0.004	0.102	ASTM D374			
Carrier Thickness (inch) / (mm)	0.0015	0.038	ASTM D374			
Continuous Use Temp (°F) / (°C)	248	120	—			
Phase Change Temp (°F) / (°C)	131	55	ASTM D3418			
ELECTRICAL						
Flame Rating	V-O	V-O	U.L. 94			
THERMAL						
Thermal Conductivity (W/m-K) (1)	1.0	1.0	ASTM D5470			
THERMAL PERFORMANCE vs PRESSURE						
	Pressure (psi)	10	25	50	100	200
	TO-220 Thermal Performance (°C/W)	0.87	0.68	0.57	0.50	0.45
	Thermal Impedance (°C-in ² /W) (2)	0.12	0.10	0.09	0.08	0.07

1) This is the measured thermal conductivity of the Hi-Flow coating. It represents one conducting layer in a three-layer laminate. The Hi-Flow coatings are phase change compounds. These layers will respond to heat and pressure induced stresses. The overall conductivity of the material in post-phase change, thin film products is highly dependent upon the heat and pressure applied. This characteristic is not accounted for in ASTM D5470. Please contact Bergquist Product Management if additional specifications are required.
2) The ASTM D5470 test fixture was used and the test sample was conditioned at 70°C prior to test. The recorded value includes interfacial thermal resistance. These values are provided for reference only. Actual application performance is directly related to the surface roughness, flatness and pressure applied.

Typical Applications Include:

- Computer and peripherals
- Power conversion
- High performance computer processors
- Power semiconductors
- Power modules

Configurations Available:

- Roll form, kiss-cut parts, and sheet form

Building a Part Number

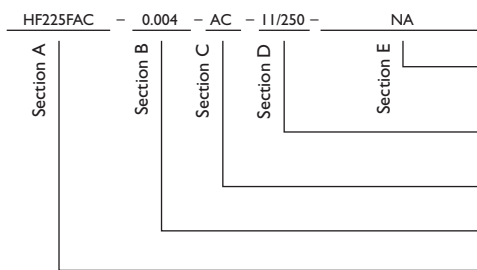

Standard Options

NA = Selected standard option. If not selecting a standard option, insert company name, drawing number, and revision level.
 ____ = Standard configuration dash number, 1112 = 11" x 12" sheets, 11/250 = 11" x 250" rolls, or 00 = custom configuration
 AC = Adhesive, one side
 Standard thicknesses available: 0.004"
 HF225FAC = Hi-Flow 225F-AC Phase Change Material

Note: To build a part number, visit our website at www.bergquistcompany.com.

Hi-Flow®: U.S. Patent 6,197,859 and others

HI-FLOW

Hi-Flow® 225FT

Reworkable, Pressure Sensitive Phase Change Material

Features and Benefits

- Thermal impedance: 0.10°C-in²/W (@25 psi)
- Reworkable pressure sensitive
- Tabbed parts for easy application
- Compliant foil allows easy release and rework

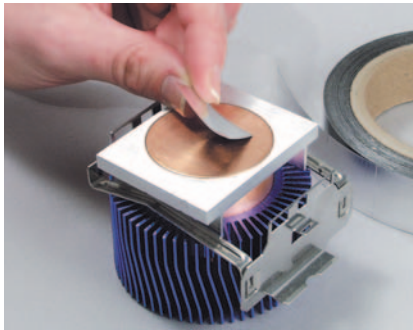

Bergquist reworkable Hi-Flow 225FT thermal interface material provides a low thermal resistance path between hot components such as high performance processors and heat sinks. The material consists of a 55°C phase change compound bonded to one side of a conformable metal foil. This pressure sensitive material is easily applied to the heat sink and securely conforms to many mounting surfaces. Its compliant foil allows for easy release and reworking without leaving residue on CPU surfaces.

Above the 55°C phase change temperature, Hi-Flow 225FT wets-out the heat sink interface and flows to produce exceptional thermal performance. The thixotropic design of Hi-Flow 225FT requires pressure of the assembly to cause displacement and/or flow.

Application Methods

1. Hi-Flow 225FT pads are easily removed from the carrier liner and can be hand-applied to a room temperature heat sink, foil-side exposed. To reposition the heat sink assembly, simply lift gently to remove and reapply.

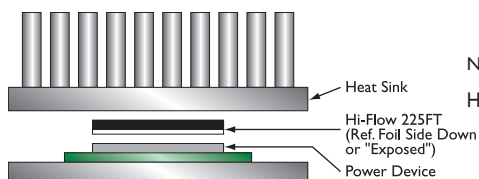

TYPICAL PROPERTIES OF HI-FLOW 225FT						
PROPERTY	IMPERIAL VALUE	METRIC VALUE	TEST METHOD			
Color	Black	Black	Visual			
Reinforcement Carrier	Aluminum	Aluminum	—			
Thickness (inch) / (mm)	0.004	0.102	ASTM D374			
Carrier Thickness (inch) / (mm)	0.001	0.025	ASTM D374			
Continuous Use Temp (°F) / (°C)	248	120	—			
Phase Change Temp (°F) / (°C)	131	55	ASTM D3418			
ELECTRICAL						
Flame Rating	V-O	V-O	U.L. 94			
THERMAL						
Thermal Conductivity (W/m-K) (1)	0.7	0.7	ASTM D5470			
THERMAL PERFORMANCE vs PRESSURE						
	Pressure (psi)	10	25	50	100	200
TO-220 Thermal Performance (°C/W)		0.93	0.74	0.63	0.52	0.42
Thermal Impedance (°C-in²/W) (2)		0.13	0.10	0.09	0.07	0.06

1) This is the measured thermal conductivity of the Hi-Flow coating. It represents one conducting layer in a three-layer laminate. The Hi-Flow coatings are phase change compounds. These layers will respond to heat and pressure induced stresses. The overall conductivity of the material in post-phase change, thin film products is highly dependent upon the heat and pressure applied. This characteristic is not accounted for in ASTM D5470. Please contact Bergquist Product Management if additional specifications are required.
2) The ASTM D5470 test fixture was used and the test sample was conditioned at 70°C prior to test. The recorded value includes interfacial thermal resistance. These values are provided for reference only. Actual application performance is directly related to the surface roughness, flatness and pressure applied.

Typical Applications Include:

- Computer and peripherals
- High performance computer processors
- Burn-in testing
- Heat pipes
- Mobile processors

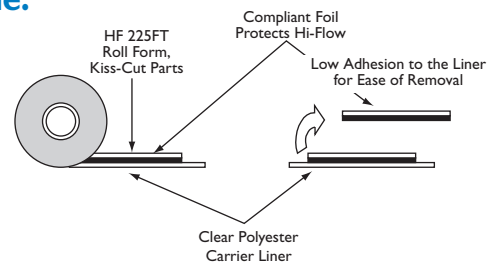

Configurations Available:

- Roll form with tabs and kiss-cut parts – no holes
- Custom thicknesses available

Hi-Flow 225FT is limited to a square or rectangular part design. Dimensional tolerance is +/- 0.020 inch (0.5mm).

Building a Part Number

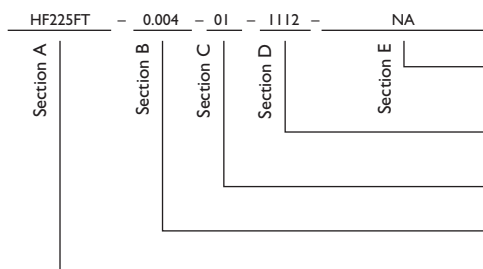

Note: To build a part number, visit our website at www.bergquistcompany.com.

Hi-Flow®: U.S. Patent 6,197,859 and others

Standard Options

NA = Selected standard option. If not selecting a standard option, insert company name, drawing number, and revision level.

111250 = Standard Hi-Flow 225FT configuration, 11/250 = 11" x 250' rolls, or 00 = custom configuration

01 = Reworkable adhesive, one side

Standard thicknesses available: 0.004"

HF225FT = Hi-Flow 225FT Phase Change Material

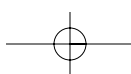

Hi-Flow[®] 225UF

Unsupported, Thermally Conductive Phase Change Material

Features and Benefits

- Thermal impedance: 0.08°C-in²/W (@25 psi)
- Reworkable
- Easy release from CPU
- Easy to handle / assemble

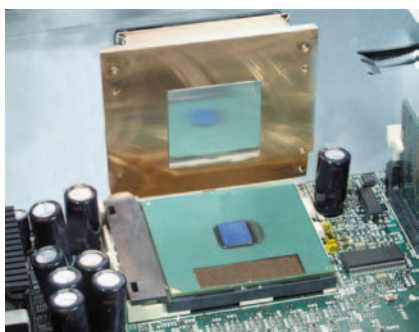

Bergquist's reworkable Hi-Flow 225UF thermal interface material provides a low thermal resistance path between hot components such as high-performance processors and heat sinks.

Hi-Flow 225UF consists of a 55°C phase change compound bonded to one side of a conformable aluminum foil. This phase change material is easily applied to a nominal 45°C heat sink and securely conforms to many mounting surfaces. The compliant foil allows for easy release from the CPU/socket assembly, leaving the surface clean and residue-free. Hi-Flow 225UF is supplied in kiss-cut form with a carrier liner protecting the phase change material from contaminants.

Above the 55°C phase change temperature, Hi-Flow 225UF wets-out the heat sink interface and flows to produce exceptional thermal performance. Hi-Flow 225UF's thixotropic design requires pressure of the assembly to cause displacement and/or flow.

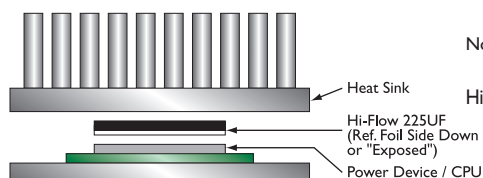

TYPICAL PROPERTIES OF HI-FLOW 225UF						
PROPERTY	IMPERIAL VALUE	METRIC VALUE	TEST METHOD			
Color	Black	Black	Visual			
Reinforcement Carrier	Aluminum	Aluminum	—			
Thickness (inch) / (mm)	0.0045	0.114	ASTM D374			
Carrier Thickness (inch) / (mm)	0.001	0.025	ASTM D374			
Continuous Use Temp (°F) / (°C)	248	120	—			
Phase Change Temp (°F) / (°C)	131	55	ASTM D3418			
THERMAL						
Thermal Conductivity (W/m-K) (1)	1.0	1.0	ASTM D5470			
THERMAL PERFORMANCE vs PRESSURE						
	Pressure (psi)	10	25	50	100	200
	TO-220 Thermal Performance (°C/W)	0.70	0.58	0.52	0.43	0.37
	Thermal Impedance (°C-in ² /W) (2)	0.10	0.08	0.07	0.06	0.05
<small>1) This is the measured thermal conductivity of the Hi-Flow coating. It represents one conducting layer in a three-layer laminate. The Hi-Flow coatings are phase change compounds. These layers will respond to heat and pressure induced stresses. The overall conductivity of the material in post-phase change, thin film products is highly dependent upon the heat and pressure applied. This characteristic is not accounted for in ASTM D5470. Please contact Bergquist Product Management if additional specifications are required. 2) The ASTM D5470 test fixture was used and the test sample was conditioned at 70°C prior to test. The recorded value includes interfacial thermal resistance. These values are provided for reference only. Actual application performance is directly related to the surface roughness, flatness and pressure applied.</small>						

Typical Applications Include:

- Spring / clip mounted:
 - Digital / high power CPU's
 - Power modules

Configurations Available:

- Sheet form, kiss-cut or bulk
 - Preferred form: squares / rectangles
- Singulated die-cut parts
 - Preferred form: squares / rectangles
- Bulk roll form

Building a Part Number

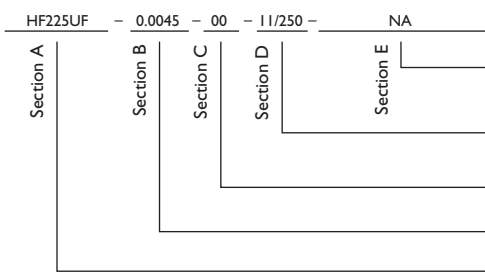

Standard Options

◀ example
 NA = Selected standard option. If not selecting a standard option, insert company name, drawing number, and revision level.
 1112 = 11" x 12" sheets, 11/250 = 11" x 250' rolls, or 00 = custom configuration
 00 = No adhesive
 Standard thicknesses available: 0.0045"
 HF225UF = Hi-Flow 225UF Phase Change Material

Note: To build a part number, visit our website at www.bergquistcompany.com.

Hi-Flow[®]: U.S. Patent 6,197,859 and others

HI-FLOW

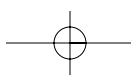

Hi-Flow[®] 225UT

Non-Reinforced, Pressure Sensitive Phase Change Thermal Interface Material

Features and Benefits

- Thermal impedance: 0.08°C-in²/W (@25 psi)
- 55°C phase change composite with inherent tack characteristics
- High-visibility protective tabs
- Pressure sensitive phase change thermal interface material

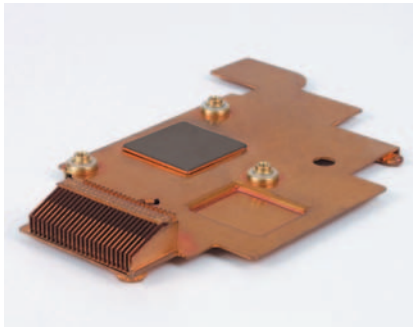

Hi-Flow 225UT is designed as a pressure sensitive thermal interface material for use between a high performance processor and a heat sink. Hi-Flow 225UT is a thermally conductive 55°C phase change composite with inherent tack. The material is supplied on a polyester carrier liner and is available with high-visibility protective tabs.

Above its phase change temperature, Hi-Flow 225UT wets-out the thermal interface surfaces and flows to produce the lowest thermal impedance. The material requires pressure of the assembly to cause flow. Hi-Flow 225UT coatings will resist dripping.

Application Methods:

1. Hand-apply Hi-Flow 225UT to a room-temperature heat sink. The Hi-Flow 225UT pad exhibits inherent tack and can be hand-applied similar to an adhesive pad. The tab liner can remain on the heat sink and pad throughout shipping and handling until it is ready for final assembly.

TYPICAL PROPERTIES OF HI-FLOW 225UT						
PROPERTY	IMPERIAL VALUE	METRIC VALUE	TEST METHOD			
Color	Black	Black	Visual			
Reinforcement Carrier	None	None	—			
Thickness (inch) / (mm)	0.003	0.077	ASTM D374			
Continuous Use Temp (°F) / (°C)	248	120	—			
Phase Change Temp (°F) / (°C)	131	55	ASTM D3418			
ELECTRICAL						
Flame Rating	V-O	V-O	U.L. 94			
THERMAL						
Thermal Conductivity (W/m-K) (1)	0.7	0.7	ASTM D5470			
THERMAL PERFORMANCE vs PRESSURE						
	Pressure (psi)	10	25	50	100	200
	TO-220 Thermal Performance (°C/W)	0.60	0.53	0.46	0.40	0.35
	Thermal Impedance (°C-in ² /W) (2)	0.09	0.08	0.07	0.06	0.05

1) This is the measured thermal conductivity of the Hi-Flow coating. It represents one conducting layer in a three-layer laminate. The Hi-Flow coatings are phase change compounds. These layers will respond to heat and pressure induced stresses. The overall conductivity of the material in post-phase change, thin film products is highly dependent upon the heat and pressure applied. This characteristic is not accounted for in ASTM D5470. Please contact Bergquist Product Management if additional specifications are required.

2) The ASTM D5470 test fixture was used and the test sample was conditioned at 70°C prior to test. The recorded value includes interfacial thermal resistance. These values are provided for reference only. Actual application performance is directly related to the surface roughness, flatness and pressure applied.

Typical Applications Include:

- Computer and peripherals
- High performance computer processors
- Graphic cards
- Power modules

Configurations Available:

- Roll form with tabs and kiss-cut parts – no holes

Hi-Flow 225UT is limited to a square or rectangular part design. Dimensional tolerance is +/- 0.020 inch (0.5mm).

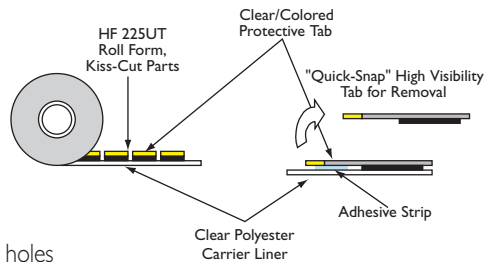

Building a Part Number

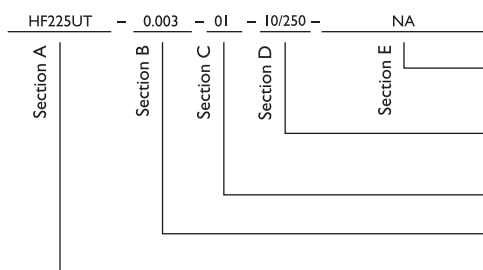

Standard Options

NA = Selected standard option. If not selecting a standard option, insert company name, drawing number, and revision level.

10/250 = Standard Hi-Flow 225UT configuration, 10/250 = 10" x 250' rolls, or 00 = custom configuration

01 = Pressure sensitive adhesive, one side

Standard thicknesses available: 0.003", 0.005"

HF225UT = Hi-Flow 225UT Phase Change Material

Note: To build a part number, visit our website at www.bergquistcompany.com.

Hi-Flow[®]: U.S. Patent 6,197,859 and others

HI-FLOW

Hi-Flow® 225U

Non-Reinforced Phase Change Thermal Interface Material

Features and Benefits

- Thermal impedance: 0.07°C-in²/W (@25 psi)
- Hi-Flow coating will resist dripping
- Thermally conductive 55°C phase change compound
- Available in roll form with kiss-cut parts

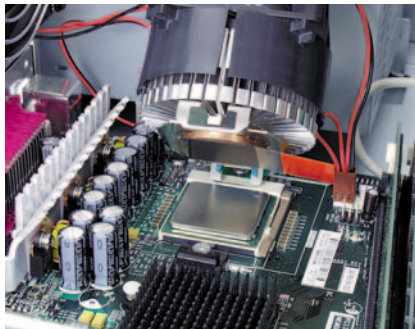

Hi-Flow 225U is designed for use as a thermal interface material between a computer processor and a heat sink. The product consists of a thermally conductive 55°C phase change compound coated on a release liner and supplied on a carrier.

Above its phase change temperature, Hi-Flow 225U wets-out the thermal interface surfaces and flows to produce low thermal impedance. Hi-Flow 225U requires pressure of the assembly to cause flow.

Application Methods:

1. Hand-apply to 35°- 45°C heat sink. The heat sink is heated in an oven or via heat gun to between 35°- 45°C. The Hi-Flow 225U part is then applied like an adhesive pad. The heat sink is cooled to room temperature and packaged. A protective tab liner remains in place until the unit is ready for final assembly. The protective tab can be readily removed from the applied Hi-Flow 225U pad at a maximum temperature of 28°C.
2. Automated equipment with 30-psi pressure. A pick-and-place automated dispensing unit can be used to apply the Hi-Flow 225U pad to a room-temperature heat sink. The placement head should have a silicone rubber pad, and should apply approximately 30-psi pressure to the pad on transfer to the 25° – 35°C heat sink. Once applied, the protective tab can be readily removed from the Hi-Flow 225U pad at a maximum temperature of 28°C.

TYPICAL PROPERTIES OF HI-FLOW 225U						
PROPERTY	IMPERIAL VALUE	METRIC VALUE	TEST METHOD			
Color	Black	Black	Visual			
Reinforcement Carrier	None	None	—			
Thickness (inch) / (mm)	0.0015	0.036	ASTM D374			
Continuous Use Temp (°F) / (°C)	302	150	—			
Phase Change Temp (°F) / (°C)	131	55	ASTM D3418			
ELECTRICAL						
Flame Rating	V-O	V-O	U.L. 94			
THERMAL						
Thermal Conductivity (W/m-K) (1)	1.0	1.0	ASTM D5470			
THERMAL PERFORMANCE vs PRESSURE						
	Pressure (psi)	10	25	50	100	200
	TO-220 Thermal Performance (°C/W)	0.53	0.47	0.39	0.34	0.32
	Thermal Impedance (°C-in²/W) (2)	0.08	0.07	0.06	0.05	0.04

1) This is the measured thermal conductivity of the Hi-Flow coating. It represents one conducting layer in a three-layer laminate. The Hi-Flow coatings are phase change compounds. These layers will respond to heat and pressure induced stresses. The overall conductivity of the material in post-phase change, thin film products is highly dependent upon the heat and pressure applied. This characteristic is not accounted for in ASTM D5470. Please contact Bergquist Product Management if additional specifications are required.
 2) The ASTM D5470 test fixture was used and the test sample was conditioned at 70°C prior to test. The recorded value includes interfacial thermal resistance. These values are provided for reference only. Actual application performance is directly related to the surface roughness, flatness and pressure applied.

Typical Applications Include:

- Computer and peripherals
- High performance computer processors
- Graphic cards
- Power modules

Configurations Available:

- Roll form with tabs and kiss-cut parts – no holes

Hi-Flow 225U is limited to a square or rectangular part design. Dimensional tolerance is +/- 0.020 inch (0.5mm).

Building a Part Number

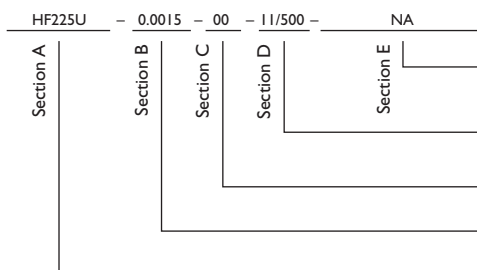

Standard Options

NA = Selected standard option. If not selecting a standard option, insert company name, drawing number, and revision level.
 --- = Standard Hi-Flow 225U configuration, 11/500 = 11" x 500' rolls, or 00 = custom configuration
 00 = No adhesive
 Standard thicknesses available: 0.0015"
 HF225U = Hi-Flow 225U Phase Change Material

Note: To build a part number, visit our website at www.bergquistcompany.com.

Hi-Flow®: U.S. Patent 6,197,859 and others

HI-FLOW

Hi-Flow® 625

Electrically Insulating, Thermally Conductive Phase Change Material

Features and Benefits

- Thermal impedance: 0.71°C-in²/W (@25 psi)
- Electrically isolating
- 65°C phase change compound coated on PEN film
- Tack-free and scratch-resistant

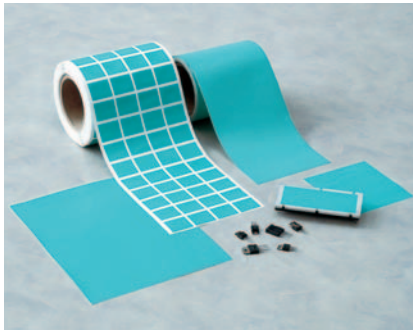

Hi-Flow 625 is a film-reinforced phase change material. The product consists of a thermally conductive 65°C phase change compound coated on PEN film. Hi-Flow 625 is designed to be used as a thermal interface material between electronic power devices that require electrical isolation and a heat sink. The reinforcement makes Hi-Flow 625 easy to handle, and the 65°C phase change temperature of the coating material eliminates shipping and handling problems. The PEN film has a continuous use temperature of 150°C.

Hi-Flow 625 is tack-free and scratch-resistant at production temperature and does not require a protective liner in most shipping situations. The material has the thermal performance of 2-3 mil mica and grease assemblies.

TYPICAL PROPERTIES OF HI-FLOW 625						
PROPERTY	IMPERIAL VALUE	METRIC VALUE	TEST METHOD			
Color	Green	Green	Visual			
Reinforcement Carrier	PEN Film	PEN Film	—			
Thickness (inch) / (mm)	0.005	0.127	ASTM D374			
Elongation (%45° to Warp and Fill)	60	60	ASTM D882A			
Tensile Strength (psi) / (MPa)	30,000	206	ASTM D882A			
Continuous Use Temp (°F) / (°C)	302	150	—			
Phase Change Temp (°F) / (°C)	149	65	ASTM D3418			
ELECTRICAL						
Dielectric Breakdown Voltage (Vac)	4000	4000	ASTM D149			
Dielectric Constant (1000 Hz)	3.5	3.5	ASTM D150			
Volume Resistivity (Ohm-meter)	10 ¹⁰	10 ¹⁰	ASTM D257			
Flame Rating	V-O	V-O	U.L. 94			
THERMAL						
Thermal Conductivity (W/m-K) (1)	0.5	0.5	ASTM D5470			
THERMAL PERFORMANCE vs PRESSURE						
	Pressure (psi)	10	25	50	100	200
TO-220 Thermal Performance (°C/W)		2.26	2.10	2.00	1.93	1.87
Thermal Impedance (°C-in²/W) (2)		0.79	0.71	0.70	0.67	0.61

1) This is the measured thermal conductivity of the Hi-Flow coating. It represents one conducting layer in a three-layer laminate. The Hi-Flow coatings are phase change compounds. These layers will respond to heat and pressure induced stresses. The overall conductivity of the material in post-phase change, thin film products is highly dependent upon the heat and pressure applied. This characteristic is not accounted for in ASTM D5470. Please contact Bergquist Product Management if additional specifications are required.
2) The ASTM D5470 test fixture was used and the test sample was conditioned at 70°C prior to test. The recorded value includes interfacial thermal resistance. These values are provided for reference only. Actual application performance is directly related to the surface roughness, flatness and pressure applied.

Typical Applications Include:

- Spring / clip mounted
- Power semiconductors
- Power modules

Configurations Available:

- Sheet form, die-cut parts and roll form
- With or without pressure sensitive adhesive

Building a Part Number

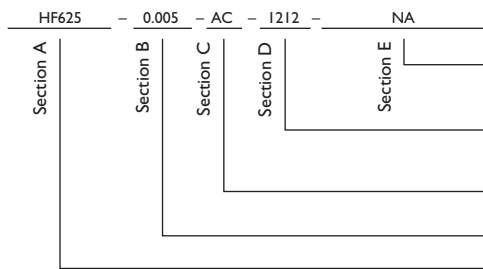

Standard Options

NA = Selected standard option. If not selecting a standard option, insert company name, drawing number, and revision level.

— = Standard configuration dash number, I212 = 12" x 12" sheets, I2/250 = 12" x 250' rolls, or 00 = custom configuration

AC = Adhesive, one side
00 = No adhesive

Standard thicknesses available: 0.005"

HF625 = Hi-Flow 625 Phase Change Material

Note: To build a part number, visit our website at www.bergquistcompany.com.

Hi-Flow®: U.S. Patents 6,197,859 and 5,950,066.

HI-FLOW

Hi-Flow[®] 300P

Electrically Insulating, Thermally Conductive Phase Change Material

Features and Benefits

- Thermal impedance: 0.13°C-in²/W (@25 psi)
- Field-proven polyimide film
 - excellent dielectric performance
 - excellent cut-through resistance
- Outstanding thermal performance in an insulated pad

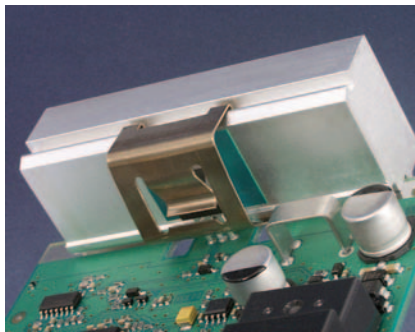

Hi-Flow 300P consists of a thermally conductive 55°C phase change compound coated on a thermally conductive polyimide film. The polyimide reinforcement makes the material easy to handle and the 55°C phase change temperature minimizes shipping and handling problems.

Hi-Flow 300P achieves superior values in voltage breakdown and thermal performance when compared to its competition. The product is supplied on an easy release liner for exceptional handling in high volume manual assemblies. Hi-Flow 300P is designed for use as a thermal interface material between electronic power devices requiring electrical isolation to the heat sink.

Bergquist suggests the use of spring clips to assure constant pressure with the interface and power source. Please refer to thermal performance data to determine nominal spring pressure for your application.

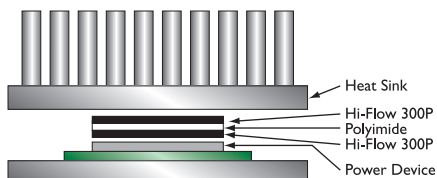

We produce thousands of specials. Tooling charges vary depending on tolerances and complexity of the part.

TYPICAL PROPERTIES OF HI-FLOW 300P						
PROPERTY	IMPERIAL VALUE	METRIC VALUE	TEST METHOD			
Color	Green	Green	Visual			
Reinforcement Carrier	Polyimide	Polyimide	—			
Thickness (inch) / (mm)	0.004 - 0.005	0.102 - 0.127	ASTM D374			
Film Thickness (inch) / (mm)	0.001 - 0.002	0.025 - 0.050	ASTM D374			
Elongation (%45° to Warp and Fill)	40	40	ASTM D882A			
Tensile Strength (psi) / (MPa)	7000	48	ASTM D882A			
Continuous Use Temp (°F) / (°C)	302	150	—			
Phase Change Temp (°F) / (°C)	131	55	ASTM D3418			
ELECTRICAL						
Dielectric Breakdown Voltage (Vac)	5000	5000	ASTM D149			
Dielectric Constant (1000 Hz)	4.5	4.5	ASTM D150			
Volume Resistivity (Ohm-meter)	10 ¹²	10 ¹²	ASTM D257			
Flame Rating	V-O	V-O	U.L. 94			
THERMAL						
Thermal Conductivity (W/m-K) (1)	1.6	1.6	ASTM D5470			
THERMAL PERFORMANCE vs PRESSURE						
	Pressure (psi)	10	25	50	100	200
TO-220 Thermal Performance (°C/W) 0.0010"		0.95	0.94	0.92	0.91	0.90
TO-220 Thermal Performance (°C/W) 0.0015"		1.19	1.17	1.16	1.14	1.12
TO-220 Thermal Performance (°C/W) 0.0020"		1.38	1.37	1.35	1.33	1.32
Thermal Impedance (°C-in ² /W) 0.0010" (2)		0.13	0.13	0.12	0.12	0.12
Thermal Impedance (°C-in ² /W) 0.0015" (2)		0.17	0.16	0.16	0.16	0.15
Thermal Impedance (°C-in ² /W) 0.0020" (2)		0.19	0.19	0.19	0.18	0.18

1) This is the measured thermal conductivity of the Hi-Flow coating. It represents one conducting layer in a three-layer laminate. The Hi-Flow coatings are phase change compounds. These layers will respond to heat and pressure induced stresses. The overall conductivity of the material in post-phase change, thin film products is highly dependent upon the heat and pressure applied. This characteristic is not accounted for in ASTM D5470. Please contact Bergquist Product Management if additional specifications are required.
 2) The ASTM D5470 test fixture was used and the test sample was conditioned at 70°C prior to test. The recorded value includes interfacial thermal resistance. These values are provided for reference only. Actual application performance is directly related to the surface roughness, flatness and pressure applied.

Typical Applications Include:

- Spring / clip mounted
- Discrete power semiconductors and modules

Configurations Available:

- Roll form, die-cut parts and sheet form, with or without pressure sensitive adhesive

Building a Part Number

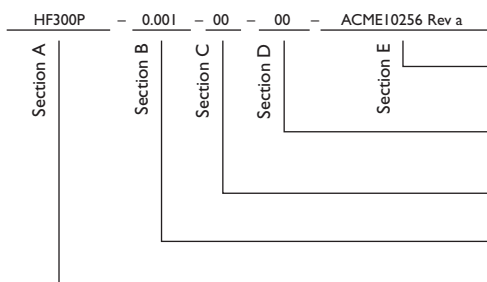

Standard Options

NA = Selected standard option. If not selecting a standard option, insert company name, drawing number, and revision level.
 ____ = Standard configuration dash number, 1112 = 11" x 12" sheets, 11/250 = 11" x 250' rolls, or 00 = custom configuration
 AC = Adhesive, one side
 00 = No adhesive
 Standard polyimide thicknesses available: 0.001", 0.0015", 0.002"
 HF300P = Hi-Flow 300P Phase Change Material

Note: To build a part number, visit our website at www.bergquistcompany.com.

Hi-Flow[®]: U.S. Patent 6,197,859 and others

Hi-Flow[®] 300G

Fiberglass-Reinforced, Phase Change Thermal Interface Material

Features and Benefits

- Thermal impedance: 0.20°C-in²/W (@25 psi)
- Will not drip or run like grease
- Phase change compound coated on a fiberglass carrier

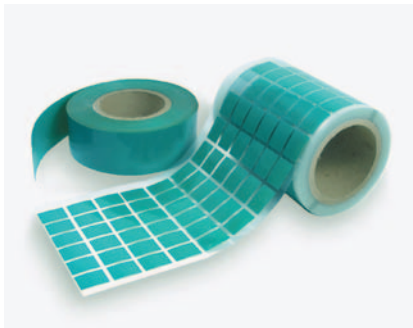

Hi-Flow 300G consists of a thermally conductive 55°C phase change compound coated on a fiberglass web. Hi-Flow 300G is designed as a thermal interface material between a computer processor and a heat sink.

Above the phase change temperature, Hi-Flow 300G wets-out the thermal interface surfaces and flows to produce low thermal impedance. The material requires pressure of the assembly to cause flow. Hi-Flow 300G will not drip or run like grease.

Application Methods

1. Hand-apply to 40° - 50°C heat sink. The heat sink is heated in an oven or by a heat gun to between 40° - 50°C allowing the Hi-Flow 300G pad to be applied like an adhesive pad. The heat sink is then cooled to room temperature and packaged.
2. Hand-apply to 20° - 35°C heat sink. Hi-Flow 300G can be applied to a room temperature heat sink with the assistance of a foam roller. The pad is positioned on the heat sink and a hand roller is used to apply pressure of 30 psi.
3. Automated equipment with 30 psi pressure. A pick-and-place automated dispensing unit can be used to apply Hi-Flow 300G to a room temperature heat sink. The placement head should have a soft silicone rubber pad, and apply 30 psi pressure to the pad on transfer to the 20° - 35°C heat sink.

TYPICAL PROPERTIES OF HI-FLOW 300G						
PROPERTY	IMPERIAL VALUE	METRIC VALUE	TEST METHOD			
Color	Green	Green	Visual			
Reinforcement Carrier	Fiberglass	Fiberglass	—			
Thickness (inch) / (mm)	0.005	0.127	ASTM D374			
Elongation (%45° to Warp and Fill)	40	40	ASTM D882A			
Tensile Strength (psi) / (MPa)	400	3	ASTM D882A			
Continuous Use Temp (°F) / (°C)	212	100	—			
Phase Change Temp (°F) / (°C)	131	55	ASTM 3418			
ELECTRICAL						
Dielectric Breakdown Voltage (Vac)	300	300	ASTM D149			
Dielectric Constant (1000 Hz)	3.5	3.5	ASTM D150			
Volume Resistivity (Ohm-meter)	10 ⁸	10 ⁸	ASTM D257			
Flame Rating	V-O	V-O	U.L. 94			
THERMAL						
Thermal Conductivity (W/m-K) (1)	1.6	1.6	ASTM D5470			
THERMAL PERFORMANCE vs PRESSURE						
	Pressure (psi)	10	25	50	100	200
	TO-220 Thermal Performance (°C/W)	0.96	0.92	0.88	0.85	0.84
	Thermal Impedance (°C-in ² /W) (2)	0.27	0.20	0.16	0.15	0.14

1) This is the measured thermal conductivity of the Hi-Flow coating. It represents one conducting layer in a three-layer laminate. The Hi-Flow coatings are phase change compounds. These layers will respond to heat and pressure induced stresses. The overall conductivity of the material in post-phase change, thin film products is highly dependent upon the heat and pressure applied. This characteristic is not accounted for in ASTM D5470. Please contact Bergquist Product Management if additional specifications are required.
2) The ASTM D5470 test fixture was used and the test sample was conditioned at 70°C prior to test. The recorded value includes interfacial thermal resistance. These values are provided for reference only. Actual application performance is directly related to the surface roughness, flatness and pressure applied.

HI-FLOW

Typical Applications Include:

- Computer and peripherals
- As a thermal interface where bare die is exposed and needs to be heat sinked

Configurations Available:

- Sheet form, die-cut parts and roll form
- With or without pressure sensitive adhesive

Building a Part Number

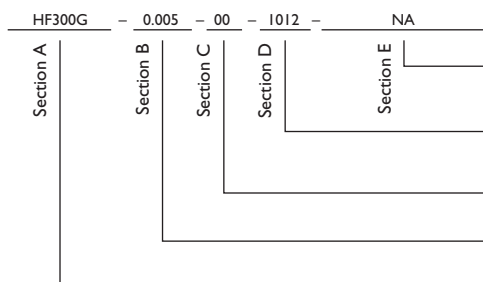

Standard Options

NA = Selected standard option. If not selecting a standard option, insert company name, drawing number, and revision level.
 — — — = Standard configuration dash number.
 1012 = 10" x 12" sheets, 10/250 = 10" x 250' rolls, or 00 = custom configuration
 AC = Adhesive, one side
 00 = No adhesive
 Standard thicknesses available: 0.005"
 HF300G = Hi-Flow 300G Phase Change Material

Note: To build a part number, visit our website at www.bergquistcompany.com.

Hi-Flow[®]: U.S. Patent 6,197,859 and others

Sil-Pad® Thermally Conductive Insulators

Solutions-Driven Thermal Management Products for Electronic Devices

Comprehensive choices for a cleaner and more efficient thermal interface

More than 25 years ago, Bergquist set the standard for elastomeric thermal interface materials with the introduction of Sil-Pad. Today, Bergquist is a world leader with a complete family of Sil-Pad materials to meet the critical needs of a rapidly changing electronics industry.

Sil-Pad thermally conductive insulators, in their many forms, continue to be a clean and efficient alternative to mica, ceramics or grease for a wide range of electronic applications. Bergquist application specialists work closely with customers to specify the proper Sil-Pad material for each unique thermal management requirement.

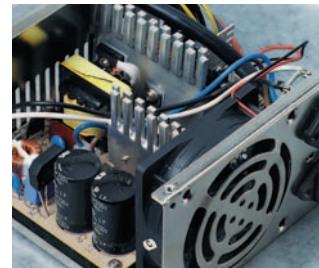
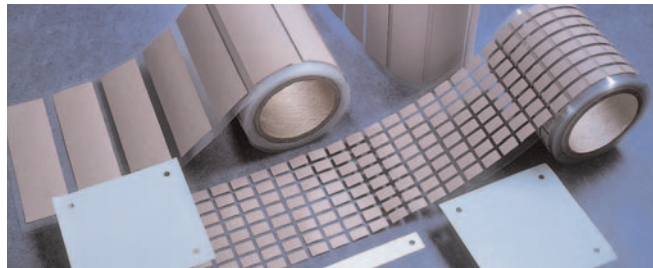
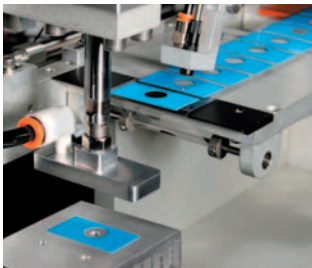

Features

The Sil-Pad family encompasses dozens of products, each with its own unique construction, properties and performance. Here are some of the important features offered by the Sil-Pad family:

- Proven silicone rubber binders
- Fiberglass, dielectric film or polyester film carriers
- Special fillers to achieve specific performance characteristics
- Flexible and conformable
- Reinforcements to resist cut-through
- Variety of thicknesses
- Wide range of thermal conductivities and dielectric strengths

Benefits

Choosing Sil-Pad thermal products saves time and money while maximizing an assembly's performance and reliability. Specifically:

- Excellent thermal performance
- Eliminates the mess of grease
- More durable than mica
- Less costly than ceramic
- Resistant to electrical shorting
- Easier and cleaner to apply
- Under time and pressure, thermal resistance will decrease
- Better performance for today's high-heat compacted assemblies
- A specific interfacial performance that matches the need
- Efficient "total applied cost" that compares favorably with other alternatives

Options

Some Sil-Pad products have special features for particular applications. Options include:

- Available with or without adhesive
- Some configurations are well suited for automated dispensing and/or placement
- Aluminum foil or imbedded graphite construction for applications not requiring electrical insulation
- Copper shield layer
- Polyester binder material for silicone-sensitive applications
- Polyimide film carrier for increased voltage breakdown
- Materials with reduced moisture sensitivity
- Available in rolls, sheets, tubes and custom die-cut parts
- Custom thicknesses and constructions

We produce thousands of specials. Tooling charges vary depending on the complexity of the part.

Applications

The large family of Sil-Pad thermally conductive insulators is extremely versatile. In today's marketplace, Sil-Pads are used in virtually every component of the electronics industry, including:

- Interface between a power transistor, CPU or other heat-generating component and a heat sink or rail
- Isolate electrical components and power sources from heat sink and/or mounting bracket
- Interface for discrete semiconductors requiring low-pressure spring-clamp mounting
- Consumer electronics
- Automotive systems
- Telecommunications
- Aerospace
- Military
- Medical devices
- Industrial controls

SIL-PAD

Sil-Pad® Comparison Data

TO-220 Thermal Performance

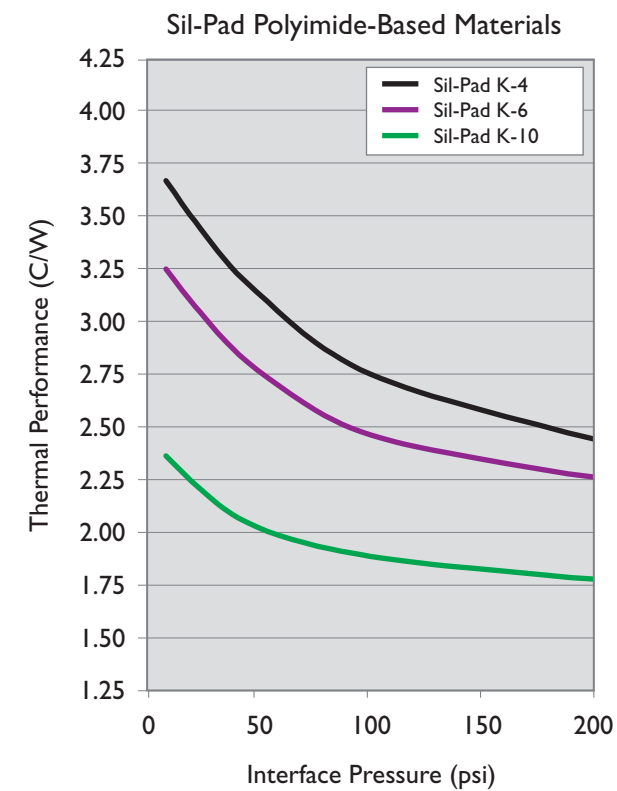
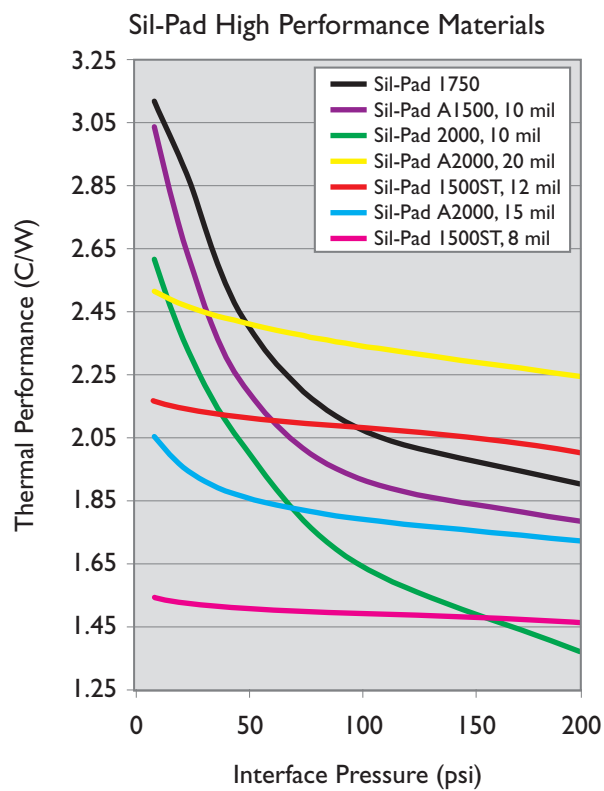
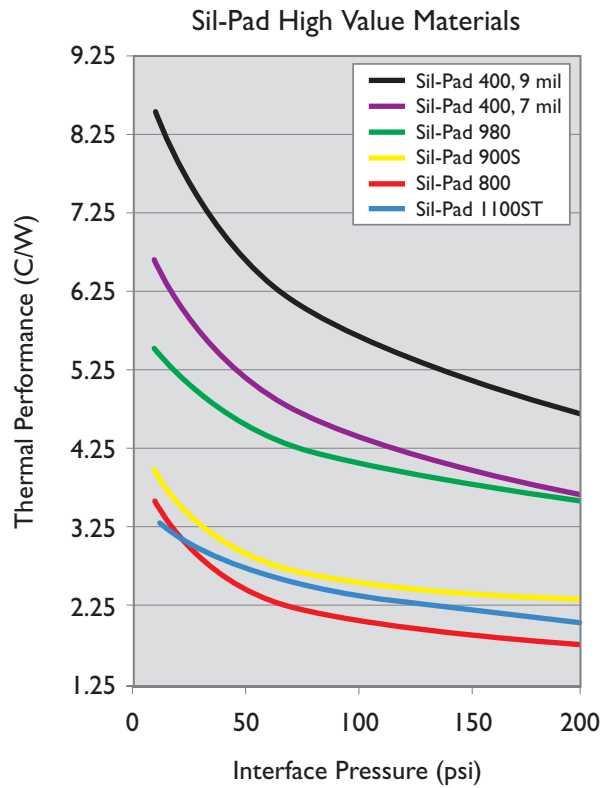
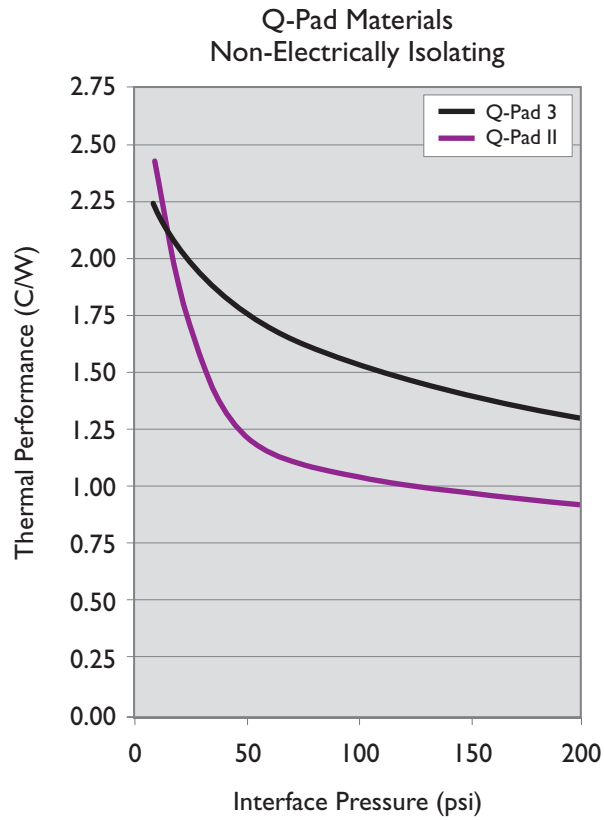

SIL-PAD

Frequently Asked Questions

Q: What is the primary difference between Sil-Pad A2000 and Sil-Pad 2000 products?

A: Sil-Pad A2000 utilizes a different filler package than Sil-Pad 2000. This change results in a more compliant Sil-Pad A2000 material that inherently lowers interfacial resistance losses. This reduction in interfacial resistance results in improved overall thermal performance when measured at lower pressures in standard ASTM D5470 and TO-220 testing.

Q: When should I choose Sil-Pad A2000 versus Sil-Pad 2000 for my application?

A: The answer is based on the assumption that the primary design intent is to increase thermal performance. If your application utilizes lower clamping pressures (e.g. 10 to 75 psi) you will find the Sil-Pad A2000 to provide excellent thermal performance. In contrast, if you are designing for higher clamping pressures (e.g. 100 psi or greater), it is likely that you will require the thermal performance characteristics of the Sil-Pad 2000.

Q: Are there differences in electrical characteristics between Sil-Pad A2000 and Sil-Pad 2000?

A: Yes. Bergquist evaluates and publishes voltage breakdown, dielectric constant and volume resistivity data per ASTM standards for these materials. Due to differences between ASTM lab testing and actual application performance, for best results, these characteristics should be evaluated within the actual customer system.

Q: Can I get Sil-Pad A2000 in roll form?

A: Yes. With the new environmentally "green" process improvements added with the introduction of Sil-Pad A2000 products, the materials are now available in roll form. The original Sil-Pad 2000 material cannot be produced in continuous roll form.

Q: When should I choose Sil-Pad 800 versus Sil-Pad 900S for my application?

A: Sil-Pad 800 is specifically formulated to provide excellent thermal performance for discrete semiconductor applications that utilize low clamping pressures (e.g. spring clips at 10 to 50 psi). In contrast, if you are designing for higher clamping pressure applications using discrete semi-conductors (e.g. 50 to 100 psi), it is likely that you will prefer the combination of high thermal performance and cut-through resistance inherent in Sil-Pad 900S material.

Q: When should I choose Sil-Pad 980 versus Sil-Pad 900S for my application?

A: Sil-Pad 980 is specifically formulated to provide superior cut-through and crush resistance in combination with excellent heat transfer and dielectric properties. Sil-Pad 980 has a proven history of reliability in high-pressure applications where surface imperfections such as burrs and dents are inherently common. These applications often include heavily machined metal surfaces manufactured from extrusions or castings. Sil-Pad 900S carries a high level of crush resistance and is more likely to be used in burr-free or controlled-surface finish applications.

Q: Is there an adhesive available for Sil-Pad 1500ST and Sil-Pad 1100ST?

A: Sil-Pad 1500ST and Sil-Pad 1100ST have an inherent tack on both sides of the material. This inherent tack is used instead of an adhesive. The tack provides sufficient adhesive for dispensing from the carrier liner and placement on the component. Sil-Pad 1500ST and Sil-Pad 1100ST can be repositioned after the initial placement.

Q: Why is the thermal performance curves of Sil-Pad 1500ST and Sil-Pad 1100ST so flat when compared to other Sil-Pads?

A: Sil-Pad 1500ST and Sil-Pad 1100ST wet-out the application surfaces at a very low pressures. Optimal thermal performance is achieved at pressures as low as 50 psi.

Q: How do I know which Sil-Pad is right for my specific application?

A: Each application has specific characteristics (e.g. surface finish, flatness tolerances, high pressure requirements, potential burrs, etc.) that determine which Sil-Pad will optimize thermal performance. Select a minimum of two pads that best fit the application, then conduct testing to determine which material performs the best.

Q: What is ISO9001:2000?

A: The ISO certification is the adoption of a quality management system that is a strategic decision of the organization. This International Standard specifies requirements for a quality management system where an organization: a) needs to demonstrate its ability to consistently provide product that meets customer and applicable regulatory requirements, and b) aims to enhance customer satisfaction through the effective application of the system, including processes for continual improvement of the system and the assurance of conformity to customer and regulatory requirements.

Why Choose Sil-Pad Thermally Conductive Insulators?

Overview

The Bergquist Company established the standard for elastomeric, thermally conductive insulation materials with the development of Sil-Pad over 25 years ago. Sil-Pad was developed as a clean, grease-free alternative to mica and grease. Now, a complete family of materials is available to meet the diverse and changing requirements of today's design engineer.

Mica and Grease

Mica insulators have been in use for over 35 years and are still commonly used as an insulator. Mica is inexpensive and has excellent dielectric strength, but it is brittle and is easily cracked or broken. Because mica used by itself has high thermal impedance, thermal grease is commonly applied to it. The grease flows easily and excludes air from the interface to reduce the interfacial thermal resistance. If the mica is also thin (2-3 mils [50-80 μm]), a low thermal impedance can be achieved.

However, thermal grease introduces a number of problems to the assembly process. It is time-consuming to apply, messy and difficult to clean. Once thermal grease has been applied to an electronic assembly, solder processes must be avoided to prevent contamination of the solder. Cleaning baths must also be avoided to prevent wash-out of the interface grease, causing a dry joint and contamination of the bath. Assembly, soldering and cleaning processes must be performed in one process while the greased insulators are installed off-line in a secondary process. If the grease is silicone-based, migration of silicone molecules occurs over time, drying out the grease and contaminating the assembly. Silicone migration onto electrical contacts can result in the loss of electrical conductance. For this reason, silicone-based thermal grease has not been used in telecommunications systems.



Polyimide Films

Polyimide films can also be used as insulators and are often combined with wax or grease to achieve a low thermal impedance. These polyimide films are especially tough and have high dielectric strength. Sil-Pad K-4, K-6 and K-10 incorporate polyimide film as the carrier material.



Ceramic Insulators

Other insulation materials include ceramic wafer insulators which have a higher thermal conductivity than mica. They are often used thicker (20-60 mils), (.5 to 1.5 mm) to reduce capacitive coupling while maintaining a low thermal impedance.

Drawbacks to ceramic insulators are their high cost and, like mica, they are rigid and crack easily. Also, ceramic beryllia use requires careful handling since inhalation of beryllia dust can cause lung inflammation (berylliosis).

SIL-PAD

Sil-Pad Materials

Sil-Pad thermally conductive insulators are designed to be clean, grease-free and flexible. The combination of a tough carrier material such as fiberglass and silicone rubber which is conformable, provides the engineer with a more versatile material than mica or ceramics and grease. Sil-Pad products minimize the thermal resistance from the case of a power semiconductor to the heat sink. Sil-Pad materials electrically isolate the semiconductor from the heat sink and have sufficient dielectric strength to withstand high voltage. They are also strong enough to resist puncture by the facing metal surface. With more than 30 different Sil-Pad materials available, there is a Sil-Pad matched to almost any application.

Sil-Pad Construction

Sil-Pad products are constructed with a variety of different materials including fiberglass, silicone rubber, polyimide film, polyester film and fillers used to enhance performance. Sil-Pad materials are typically constructed with an elastomeric binder compounded with a thermally conductive filler coated on a carrier. The characteristics of your application often determine which Sil-Pad construction will produce the best performance.

Binders

Most Sil-Pad products use silicone rubber as the binder. Silicone rubber has a low dielectric constant, high dielectric strength, good chemical resistance and high thermal stability.

Silicone rubber also exhibits cold flow, which excludes air from the interface as it conforms to the mating surfaces. This flow eliminates the need for thermal grease. A rough-surface-textured insulator needs to flow more to exclude air than a smooth one. The smoother pads also need less pressure to wet-out the surfaces and obtain optimum thermal contact.

Carriers

The carrier provides physical reinforcement and contributes to dielectric strength. High dielectric and physical strength are obtained by using a heavy, tight mesh, but thermal resistance will suffer. A light, open mesh reduces thermal resistance, dielectric strength and cut-through resistance. The carrier materials used in Sil-Pad materials include fiberglass and dielectric film.

Fillers

The thermal conductivity of Sil-Pad products is improved by filling them with ingredients of high thermal conductivity. The fillers change the characteristics of the silicone rubber to enhance thermal and/or physical characteristics.

For instance, some fillers make the silicone rubber hard and tough while still retaining the ability to flow under pressure. A harder silicone helps the material resist cut-through. In other applications a filler is used to make the silicone rubber softer and more conformable to rough surfaces. While the range in thermal resistance of greased mica is quite large, the average is comparable to elastomeric insulators filled with a blend of the appropriate ingredients.

Fiberglass-based insulators (Sil-Pad 400 and Sil-Pad 1500) have a rough surface texture and will show a 15-20% decrease in thermal resistance over a 24-hour period. Film-based insulators (Sil-Pad K-4, Sil-Pad K-6 and Sil-Pad K-10) are smoother initially and show a 5% decrease over the same period of time.

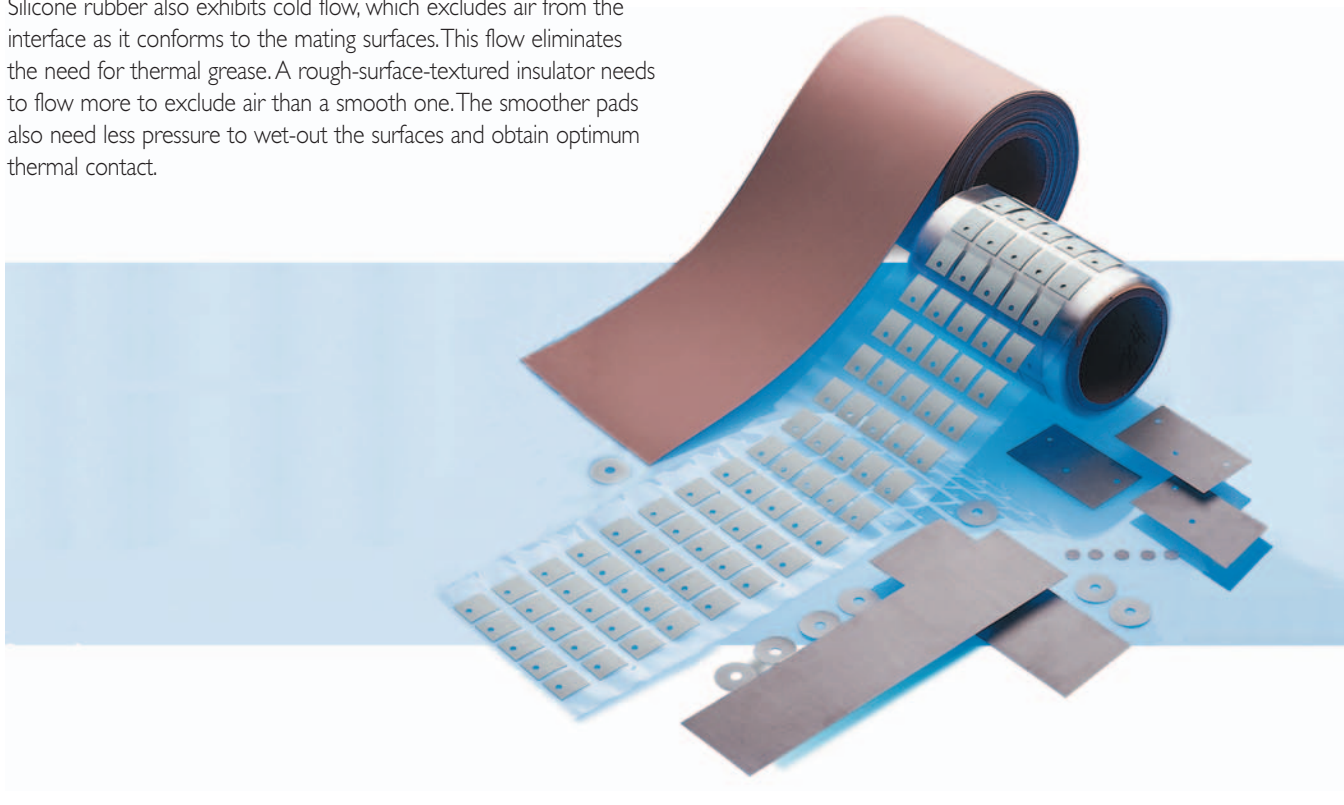

SIL-PAD

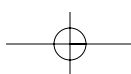

Mechanical, Electrical and Thermal Properties

Mechanical Properties

Woven fiberglass and films are used in Sil-Pad products to provide mechanical reinforcement. The most important mechanical property in Sil-Pad applications is resistance to cut-through to avoid electrical shorting from the device to the heat sink.

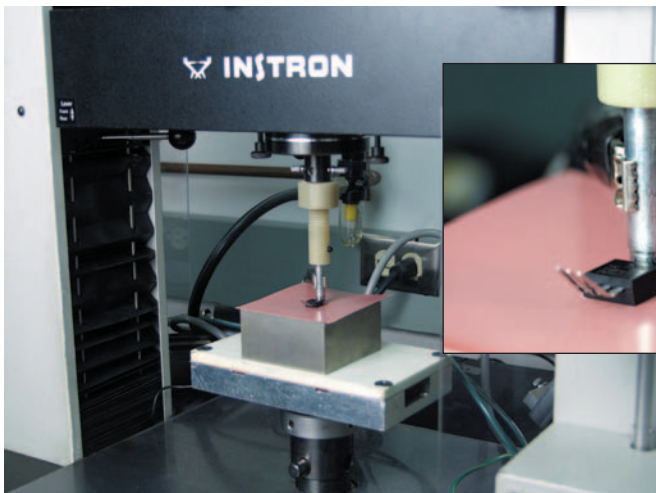

Cut-Through Resistance - Bergquist introduced its TO-220 cut-through test to help customers better understand typical application performance.

Mounting Techniques and Mounting Pressure

Typical mounting techniques include:

- A spring clip, which exerts a centralized clamping force on the body of the transistor. The greater the mounting force of the spring, the lower the thermal resistance of the insulator.
- A screw in the mounting tab. With a screw-mounted TO-220, the force on the transistor is determined by the torque applied to the fastener.

In extremely low-pressure applications, an insulator with pressure sensitive adhesive on each side may give the lowest thermal resistance since the adhesive wets-out the interface easier than the dry rubber. This decreases the interfacial thermal resistance.

Devices with larger surface areas need more pressure to get the insulator to conform to the interface than smaller devices. In most screw-mount applications, the torque required to tighten the fastener is sufficient to generate the pressure needed for optimum thermal resistance. There are exceptions where the specified torque on the fastener does not yield the optimum thermal resistance for the insulator being used and either a different insulator or a different mounting scheme should be used.

Interfacial thermal resistance decreases as time under pressure increases. In applications where high clamping forces cannot be used, time can be substituted for pressure to achieve lower thermal resistance. The only way to know precisely what the thermal resistance of an insulator will be in an application is to measure it in that application.

Electrical Properties

If your application does not require electrical insulation, Q-Pad II or Q-Pad 3 are ideal grease replacement materials. These materials do not provide electrical isolation but have excellent thermal properties. Hi-Flow phase change materials should also be considered for these applications. (Reference pages 32-44 of this guide.)

The most important electrical property in a typical assembly where a Sil-Pad insulator is used is dielectric strength. In many cases the dielectric strength of a Sil-Pad will be the determining factor in the design of the apparatus in which it is to be used.

Here are some general guidelines regarding electrical properties to consider when selecting a Sil-Pad material:

- Q-Pad II and Q-Pad 3 are used when electrical isolation is not required.
- Dielectric breakdown voltage is the total voltage that a dielectric material can withstand. When insulating electrical components from each other and ground, it is desirable to use an insulator with a high breakdown voltage.

SIL-PAD

SIL-PAD TYPICAL ELECTRICAL PROPERTIES

Material	BREAKDOWN VOLTAGE	DIELECTRIC STRENGTH		DIELECTRIC CONSTANT	VOLUME RESISTIVITY
	(kV)	(Volts/mil)	(kV/mm)	(1000 Hz)	(Ohm-Meter)
Sil-Pad 400 - 0.007	3.5	500	20	5.5	10 ¹¹
Sil-Pad 400 - 0.009	4.5	500	20	5.5	10 ¹¹
Sil-Pad 900S	5.5	600	24	6.0	10 ¹⁰
Sil-Pad A1500	6.0	600	24	7.0	10 ¹¹
Sil-Pad 2000	4.0	400	16	4.0	10 ¹¹
Sil-Pad K-4	6.0	1000	39	5.0	10 ¹²
Sil-Pad K-6	6.0	1000	39	4.0	10 ¹²
Sil-Pad K-10	6.0	1000	39	3.7	10 ¹²
Test Method	ASTM D149* * Method A, Type 3 Electrodes	ASTM D149* * Method A, Type 3 Electrodes		ASTM D150	ASTM D257

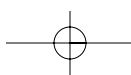

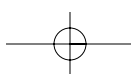

- Breakdown voltage decreases as the area of the electrodes increases. This area effect is more pronounced as the thickness of the insulator decreases.
- Breakdown voltage decreases as temperature increases.
- Breakdown voltage decreases as humidity increases (Sil-Pad 1750 is less sensitive to moisture).
- Breakdown voltage decreases in the presence of partial discharge.
- Breakdown voltage decreases as the size of the voltage source (kVA rating) increases.
- Breakdown voltage can be decreased by excessive mechanical stress on the insulator.

Dielectric strength, dielectric constant and volume resistivity should all be taken into consideration when selecting a Sil-Pad material. If your application requires specific electrical performance, please contact a Bergquist Sales Representative for more detailed testing information.

Thermal Properties

The thermal properties of a Sil-Pad material and your requirements for thermal performance probably have more to do with your selection of a Sil-Pad than any other factor.

Discrete semiconductors, under normal operating conditions, dissipate waste power which raises the junction temperature of the device. Unless sufficient heat is conducted out of the device, its electrical performance and parameters are changed. A 10°C rise in junction temperature can reduce the mean-time-to-failure of a device by a factor of two. Also,

above 25°C, the semiconductor's total power handling capability will be reduced by a derating factor inherent to the device.

The thermal properties of Sil-Pad products are thermal impedance, thermal conductivity and thermal resistance. The thermal resistance and conductivity of Sil-Pad products are inherent to the material and do not change. Thermal resistance and thermal conductivity are measured per ASTM D5470 and do not include the interfacial thermal resistance effects. Thermal impedance applies to the thermal transfer in an application and includes the effects of interfacial thermal resistance. As the material is applied in different ways, the thermal impedance values will vary from application to application.

- The original Sil-Pad material, Sil-Pad 400, continues to be Bergquist's most popular material for many applications.
- Sil-Pad A1500 is chosen when greater thermal performance is required. Sil-Pad A2000 is ideal for high performance, high reliability applications.

Beyond these standard materials, many things can contribute to the selection of the correct material for a particular application. Questions regarding the amount of torque and clamping pressure are often asked when selecting a Sil-Pad material. Here are some guidelines:

- Interfacial thermal resistance decreases as clamping pressure increases.
- The clamping pressure required to minimize interfacial thermal resistance can vary with each type of insulator.
- Sil-Pad products with smooth surface finishes (Sil-Pad A1500, Sil-Pad A2000, Sil-Pad K-4, Sil-Pad K-6 and Sil-Pad K-10) are less sensitive to clamping pressure than Sil-Pads with rough surface finishes (Sil-Pad 400) or smooth and tacky finishes (Sil-Pad 1500ST).

Sil-Pad Thermal Performance Overview (TO-220 Test @ 50 psi)

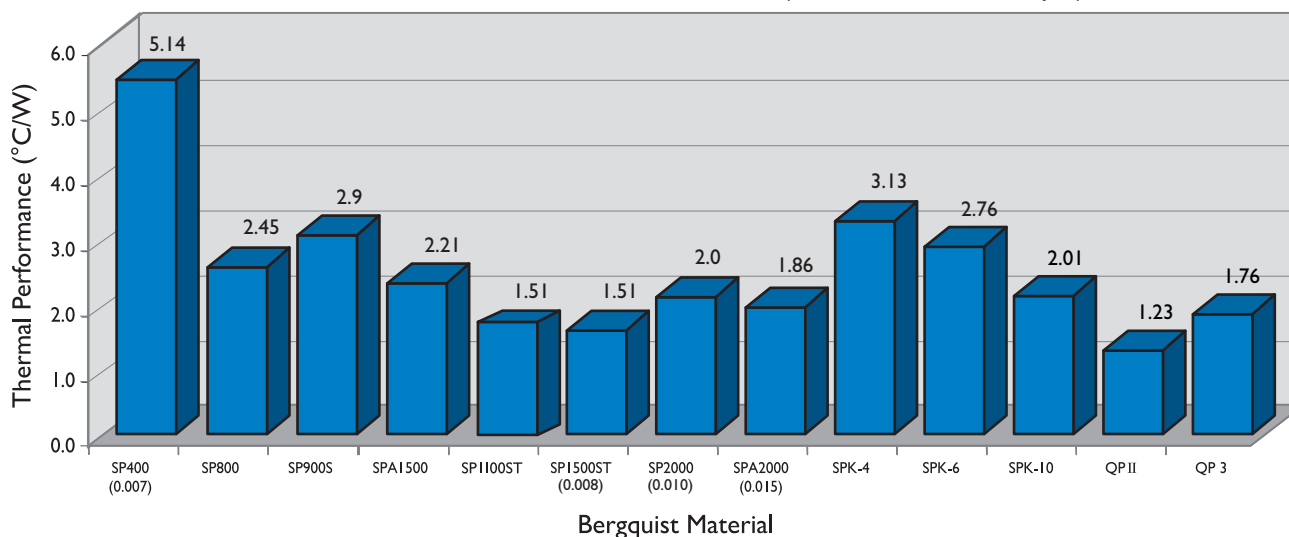

SIL-PAD

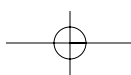

Sil-Pad® Thermally Conductive Ins

	Sil-Pad 400 .007 in.	Sil-Pad 400 .009 in.	Sil-Pad 800	Sil-Pad 900S	Sil-Pad 980	Sil-Pad A1500	Sil-Pad I100ST
Color	Gray	Gray	Gold	Pink	Mauve	Green	Yellow
Thickness (in/mm)	.007 ± .001 (.18 ± .025)	.009 ± .001 (.23 ± .025)	.005 ± .001 (.13 ± .025)	.009 ± .001 (.23 ± .025)	.009 ± .001 (.23 ± .025)	.010 ± .001 (.25 ± .025)	.012 ± .001 (.30 ± .025)
Thermal Performance TO-220 Test @ 50 psi °C/W	5.14	6.61	2.45	2.90	4.52	2.21	1.51
Thermal Impedance (°C-in ² /W)	1.13	1.45	0.45	0.61	1.07	0.42	0.66
Thermal Conductivity (W/m-K nominal)	0.9	0.9	1.6	1.6	1.2	2.0	1.1
Voltage Breakdown (Vac)	3500	4500	3000	5500	4000	6000	5000
Continuous Use Temperature (°C)	-60 to 180	-60 to 180	-60 to 180	-60 to 180	-40 to 150	-60 to 180	-60 to 180
Construction	Silicone/ Fiberglass	Silicone/ Fiberglass	Silicone/ Fiberglass	Silicone/ Fiberglass	Silicone/ Fiberglass	Silicone/ Fiberglass	Silicone/ Fiberglass

Sil-Pad Applications

SIL-PAD

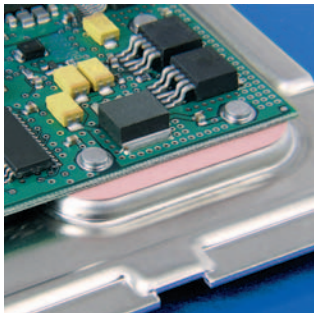

Here, Sil-Pad 900S enhances the thermal transfer from this FR-4 circuit board with thermal vias to the metal base plate.



Sil-Pad is available in over 100 standard configurations for common JEDEC package outlines.

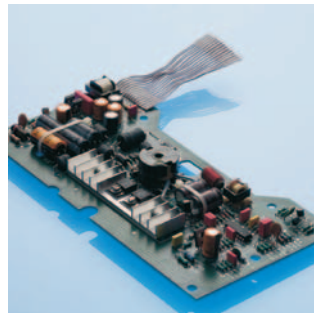

The circuit board above shows punched parts interfacing screw-mounted transistors to a finned heat sink.

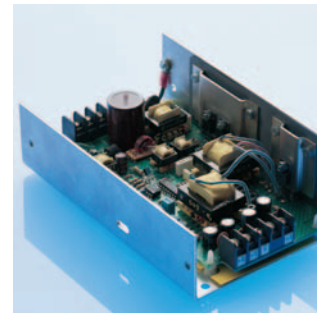

This application uses Sil-Pad to isolate the mounting brackets from the assembly frame.

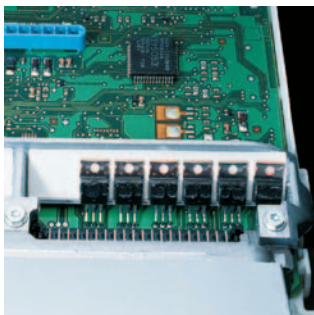

A common Sil-Pad application includes TO-220 transistors mounted in a row on a heat rail.

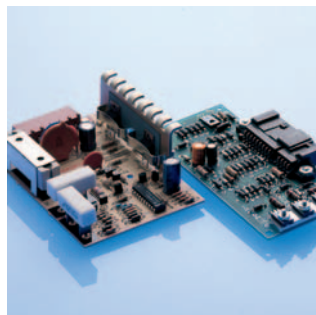

These Sil-Pad applications show clip mounting of transistors on the left and screw mounting to an aluminum bracket on the right.

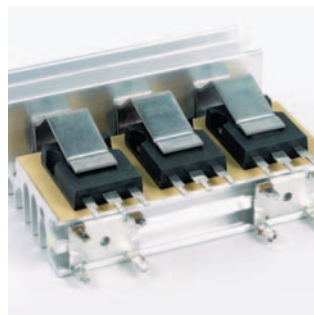

Choose a Sil-Pad that optimizes thermal performance for your mounting method — screw, clip, spring, bar, etc.



Sil-Pad 980 is used extensively in industrial applications having excellent cut-through and abrasion resistance.

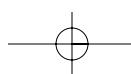

Insulator Selection Table

	Sil-Pad I500ST	Sil-Pad A2000	Sil-Pad K-4	Sil-Pad K-6	Sil-Pad K-10	Poly-Pad I000	Poly-Pad K-4	Poly-Pad K-10	Test Method
	Blue	White	Gray	Bluegreen	Beige	Yellow	Tan	Yellow	Visual
	.008 ± .001 (.20 ± .025)	.015 ± .001 (.38 ± .025)	.006 ± .001 (.15 ± .025)	.006 ± .001 (.15 ± .025)	.006 ± .001 (.15 ± .025)	.009 ± .001 (.23 ± .025)	.006 ± .001 (.15 ± .025)	.006 ± .001 (.15 ± .025)	ASTM D374
	1.51	1.86	3.13	2.76	2.01	3.74	4.34	2.75	ASTM D5470
	0.23	0.32	0.48	0.49	0.41	0.82	0.95	0.60	ASTM D5470
	1.8	3.0	0.9	1.1	1.3	1.2	0.9	1.3	ASTM D5470
	3000	4000	6000	6000	6000	2500	6000	6000	ASTM D149
	-60 to 180	-60 to 200	-60 to 180	-60 to 180	-60 to 180	-20 to 150	-20 to 150	-20 to 150	—
	Silicone/ Fiberglass	Silicone/ Fiberglass	Silicone/ Film	Silicone/ Film	Silicone/ Film	Polyester/ Fiberglass	Polyester/ Film	Polyester/ Film	—

Sil-Pad Comparison Made Simple!

Property	Test Method	Sil-Pad 400 (7 mil) Value	Sil-Pad 980 Value	Sil-Pad A1500 Value
Color	Visual	Gray	Mauve	Green
Reinforcement Carrier	---	Fiberglass	Fiberglass	Fiberglass
Thickness, (inch)	ASTM D374	0.007	0.009	0.010
Inherent Surface Tack, 1 or 2 sided	---	---	---	---
Hardness, bulk rubber, (Shore 00)	ASTM D2240	85	85	80
Continuous Use Temp., (°F)	---	-76 to 356	-40 to 302	-76 to 352
Phase Change Temp., (°F)	DSC	---	---	---
Electrical	Test Method	Value	Value	Value
Dielectric Breakdown Voltage, (Vdc)	ASTM D149	3500	4000	6000
Dielectric Constant, (1000 Hz)	ASTM D100	5.5	3.5	7.0
Volume Resistivity, (Ohm-meter)	ASTM D257	10 ¹¹	>10 ¹⁰	10 ¹¹
Flame Rating	UL	94 V-0	---	94 V-0
Thermal	Test Method	Value	Value	Value
Thermal Conductivity, (W/m-K)	ASTM D5470	0.9	1.2	2.0

Comparing thermally conductive interface materials has never been easier.

Simply go to the "Thermal Materials" section of the Bergquist website (www.bergquistcompany.com) and select "Compare Material Properties." Then select up to three separate products and this handy comparison tool will automatically chart thermal resistance values and display a material properties table of the selected materials.

The materials comparison tool can be used for most Bergquist thermal materials, including Sil-Pad, Hi-Flow, Gap Pad, Q-Pad, Bond-Ply and Liqui-Bond products.

SIL-PAD

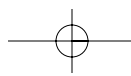

Sil-Pad® 400

The Original Sil-Pad Material

Features and Benefits

- Thermal impedance: 1.13°C-in²/W (@50 psi)
- Original Sil-Pad material
- Excellent mechanical and physical characteristics
- Flame retardant



Sil-Pad 400 is a composite of silicone rubber and fiberglass. The material is flame retardant and is specially formulated for use as a thermally conductive insulator. The primary use for Sil-Pad 400 is to electrically isolate power sources from heat sinks.

Sil-Pad 400 has excellent mechanical and physical characteristics. Surfaces are pliable and allow complete surface contact with excellent heat dissipation. Sil-Pad 400 actually improves its thermal resistance with age. The reinforcing fiberglass provides excellent cut-through resistance. In addition, Sil-Pad 400 is non-toxic and resists damage from cleaning agents.

TYPICAL PROPERTIES OF SIL-PAD 400						
PROPERTY	IMPERIAL VALUE	METRIC VALUE	TEST METHOD			
Color	Gray	Gray	Visual			
Reinforcement Carrier	Fiberglass	Fiberglass	—			
Thickness (inch) / (mm)	0.007, 0.009	0.178, 0.229	ASTM D374			
Hardness (Shore A)	85	85	ASTM D2240			
Breaking Strength (lbs/inch) / (kN/m)	30	5	ASTM D1458			
Elongation (%45° to Warp and Fill)	54	54	ASTM D412			
Tensile Strength (psi) / (MPa)	3000	20	ASTM D412			
Continuous Use Temp (°F) / (°C)	-76 to 356	-60 to 180	—			
ELECTRICAL						
Dielectric Breakdown Voltage (Vac)	3500, 4500	3500, 4500	ASTM D149			
Dielectric Constant (1000 Hz)	5.5	5.5	ASTM D150			
Volume Resistivity (Ohm-meter)	10 ¹¹	10 ¹¹	ASTM D257			
Flame Rating	V-O	V-O	U.L. 94			
THERMAL						
Thermal Conductivity (W/m-K)	0.9	0.9	ASTM D5470			
THERMAL PERFORMANCE vs PRESSURE						
	Pressure (psi)	10	25	50	100	200
TO-220 Thermal Performance (°C/W) 0.007"		6.62	5.93	5.14	4.38	3.61
TO-220 Thermal Performance (°C/W) 0.009"		8.51	7.62	6.61	5.63	4.64
Thermal Impedance (°C-in ² /W) 0.007" (1)		1.82	1.42	1.13	0.82	0.54
Thermal Impedance (°C-in ² /W) 0.009" (1)		2.34	1.83	1.45	1.05	0.69

1) The ASTM D5470 test fixture was used. The recorded value includes interfacial thermal resistance. These values are provided for reference only. Actual application performance is directly related to the surface roughness, flatness and pressure applied.

Typical Applications Include:

- Power supplies
- Automotive electronics
- Motor controls
- Power semiconductors
- U.L. File Number E59150
- CAGE Number 55285

Configurations Available:

- Sheet form, die-cut parts and roll form; with or without pressure sensitive adhesive

Building a Part Number

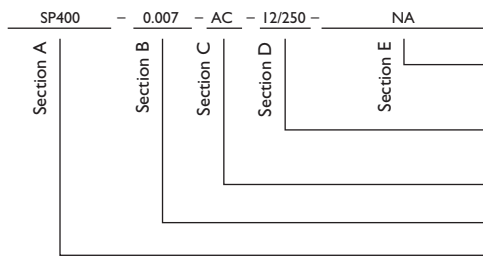

Standard Options

NA = Selected standard option. If not selecting a standard option, insert company name, drawing number, and revision level.

12/250 = Standard configuration dash number, 12/250 = 12" x 250' rolls, or 00 = custom configuration

AC = Adhesive, one side; AC2 = Adhesive, two sides; or 00 = no adhesive

Standard thicknesses available: 0.007", 0.009"

SP400 = Sil-Pad 400 Material

Note: To build a part number, visit our website at www.bergquistcompany.com.

Sil-Pad® U.S. Patents 4,574,879; 4,602,125; 4,602,678; 4,685,987; 4,842,911 and others

SIL-PAD

Sil-Pad® 800

High Performance Insulator for Low-Pressure Applications

Features and Benefits

- Thermal impedance: 0.45°C-in²/W (@50 psi)
- High value material
- Smooth and highly compliant surface
- Electrically isolating

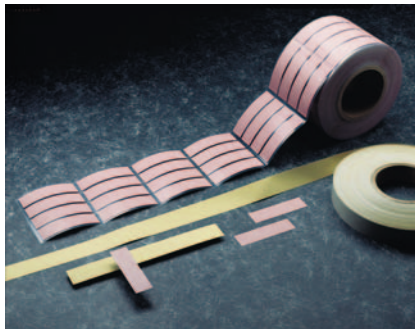

The Sil-Pad 800 family of thermally conductive insulation materials is designed for applications requiring high thermal performance and electrical isolation. These applications also typically have low mounting pressures for component clamping.

Sil-Pad 800 material combines a smooth and highly compliant surface characteristic with high thermal conductivity. These features optimize the thermal resistance properties at low pressure.

Applications requiring low component clamping forces include discrete semiconductors (TO-220, TO-247 and TO-218) mounted with spring clips. Spring clips assist with quick assembly but apply a limited amount of force to the semiconductor. The smooth surface texture of Sil-Pad 800 minimizes interfacial thermal resistance and maximizes thermal performance.

TYPICAL PROPERTIES OF SIL-PAD 800						
PROPERTY	IMPERIAL VALUE	METRIC VALUE	TEST METHOD			
Color	Gold	Gold	Visual			
Reinforcement Carrier	Fiberglass	Fiberglass	—			
Thickness (inch) / (mm)	0.005	0.127	ASTM D374			
Hardness (Shore A)	91	91	ASTM D2240			
Elongation (%45° to Warp and Fill)	20	20	ASTM D412			
Tensile Strength (psi) / (MPa)	1700	12	ASTM D412			
Continuous Use Temp (°F) / (°C)	-76 to 356	-60 to 180	—			
ELECTRICAL						
Dielectric Breakdown Voltage (Vac)	1700	1700	ASTM D149			
Type 3 Electrodes	3000	3000	ASTM D149			
Dielectric Constant (1000 Hz)	6.0	6.0	ASTM D150			
Volume Resistivity (Ohm-meter)	10 ¹⁰	10 ¹⁰	ASTM D257			
Flame Rating	V-O	V-O	U.L. 94			
THERMAL						
Thermal Conductivity (W/m-K)	1.6	1.6	ASTM D5470			
THERMAL PERFORMANCE vs PRESSURE						
	Pressure (psi)	10	25	50	100	200
TO-220 Thermal Performance (°C/W)		3.56	3.01	2.45	2.05	1.74
Thermal Impedance (°C-in ² /W) (1)		0.92	0.60	0.45	0.36	0.29
1) The ASTM D5470 test fixture was used. The recorded value includes interfacial thermal resistance. These values are provided for reference only. Actual application performance is directly related to the surface roughness, flatness and pressure applied.						

Typical Applications Include:

- Power supplies
- Automotive electronics
- Motor controls
- Power semiconductors

Configurations Available:

- Sheet form, die-cut parts and roll form
- With or without pressure sensitive adhesive

Building a Part Number

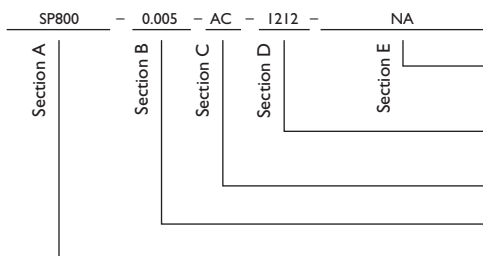

◀ example

NA = Selected standard option. If not selecting a standard option, insert company name, drawing number, and revision level.

— = Standard configuration dash number, 1212 = 12" x 12" sheets, 12/250 = 12" x 250' rolls, or 00 = custom configuration

AC = Adhesive, one side
00 = No adhesive

Standard thicknesses available: 0.005"

SP800 = Sil-Pad 800 Material

Note: To build a part number, visit our website at www.bergquistcompany.com.

Sil-Pad®: U.S. Patents 4,574,879; 4,602,125; 4,602,678; 4,685,987; 4,842,911 and others

SIL-PAD

Sil-Pad® 900S

High Performance Insulator for Low-Pressure Applications

Features and Benefits

- Thermal impedance: 0.61 °C-in²/W (@50 psi)
- Electrically isolating
- Low mounting pressures
- Smooth and highly compliant surface
- General-purpose thermal interface material solution

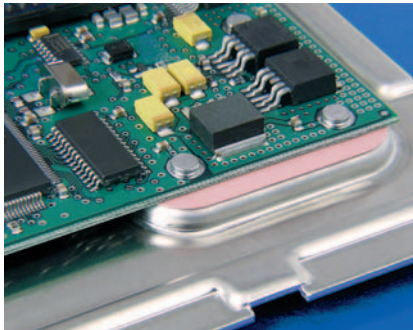

The true workhorse of the Sil-Pad product family, Sil-Pad 900S thermally conductive insulation material, is designed for a wide variety of applications requiring high thermal performance and electrical isolation. These applications also typically have low mounting pressures for component clamping.

Sil-Pad 900S material combines a smooth and highly compliant surface characteristic with high thermal conductivity. These features optimize the thermal resistance properties at low pressures.

Applications requiring low component clamping forces include discrete semiconductors (TO-220, TO-247 and TO-218) mounted with spring clips. Spring clips assist with quick assembly and apply a limited amount of force to the semiconductor. The smooth surface texture of Sil-Pad 900S minimizes interfacial thermal resistance and maximizes thermal performance.

TYPICAL PROPERTIES OF SIL-PAD 900S						
PROPERTY	IMPERIAL VALUE	METRIC VALUE	TEST METHOD			
Color	Pink	Pink	Visual			
Reinforcement Carrier	Fiberglass	Fiberglass	—			
Thickness (inch) / (mm)	0.009	0.229	ASTM D374			
Hardness (Shore A)	92	92	ASTM D2240			
Elongation (%45° to Warp and Fill)	20	20	ASTM D412			
Tensile Strength (psi) / (MPa)	1300	9	ASTM D412			
Continuous Use Temp (°F) / (°C)	-76 to 356	-60 to 180	—			
ELECTRICAL						
Dielectric Breakdown Voltage (Vac)	5500	5500	ASTM D149			
Type 3 Electrodes	8300	8300	ASTM D149			
Dielectric Constant (1000 Hz)	6.0	6.0	ASTM D150			
Volume Resistivity (Ohm-meter)	10 ¹⁰	10 ¹⁰	ASTM D257			
Flame Rating	V-O	V-O	U.L. 94			
THERMAL						
Thermal Conductivity (W/m-K)	1.6	1.6	ASTM D5470			
THERMAL PERFORMANCE vs PRESSURE						
	Pressure (psi)	10	25	50	100	200
TO-220 Thermal Performance (°C/W)		3.96	3.41	2.90	2.53	2.32
Thermal Impedance (°C-in ² /W) (1)		0.95	0.75	0.61	0.47	0.41

1) The ASTM D5470 test fixture was used. The recorded value includes interfacial thermal resistance. These values are provided for reference only. Actual application performance is directly related to the surface roughness, flatness and pressure applied.

Typical Applications Include:

- Power supplies
- Automotive electronics
- Motor controls
- Power semiconductors

Configurations Available:

- Sheet form, die-cut parts and roll form
- With or without pressure sensitive adhesive

Building a Part Number

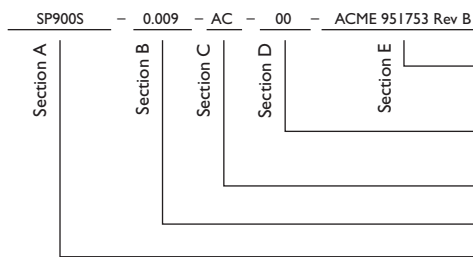

Standard Options

NA = Selected standard option. If not selecting a standard option, insert company name, drawing number, and revision level.

____ = Standard configuration dash number.
 1212 = 12" x 12" sheets, 12/250 = 12" x 250' rolls, or
 00 = custom configuration

AC = Adhesive, one side
 00 = No adhesive

Standard thicknesses available: 0.009"

SP900S = Sil-Pad 900S Material

Note: To build a part number, visit our website at www.bergquistcompany.com.

Sil-Pad®: U.S. Patents 4,574,879; 4,602,125; 4,602,678; 4,685,987; 4,842,911 and others

SIL-PAD

Sil-Pad® 980

High Cut-Through Resistant, Electrically Insulating, Thermally Conductive Material

Features and Benefits

- Thermal impedance: 1.07°C-in²/W (@50 psi)
- Excellent cut-through resistance
- Use in screw-mounted applications with cut-through problems



In addition to excellent heat transfer and dielectric properties, Sil-Pad 980 is specially formulated for high resistance to crushing and cut-through typically found in high-pressure applications where surface imperfections such as burrs and dents are inherently common (e.g. heavily-machined metal surfaces manufactured from extrusions or castings).

With a field-proven history of reliability, Sil-Pad 980 is Bergquist's best material for cut-through resistance in screw-mounted and other applications with cut-through problems.

TYPICAL PROPERTIES OF SIL-PAD 980						
PROPERTY	IMPERIAL VALUE	METRIC VALUE	TEST METHOD			
Color	Mauve	Mauve	Visual			
Reinforcement Carrier	Fiberglass	Fiberglass	—			
Thickness (inch) / (mm)	0.009	0.229	ASTM D374			
Hardness (Shore A)	95	95	ASTM D2240			
Breaking Strength (lbs/inch) / (kN/m)	140	26	ASTM D1458			
Elongation (%45° to Warp and Fill)	10	10	ASTM D412			
Cut-Through (lbs) / (kg)	750	340	ASTM D412			
Continuous Use Temp (°F) / (°C)	-40 to 302	-40 to 150	—			
ELECTRICAL						
Dielectric Breakdown Voltage (Vac)	4000	4000	ASTM D149			
Dielectric Constant (1000 Hz)	6.0	6.0	ASTM D150			
Volume Resistivity (Ohm-meter)	10 ¹⁰	10 ¹⁰	ASTM D257			
THERMAL						
Thermal Conductivity (W/m-K)	1.2	1.2	ASTM D5470			
THERMAL PERFORMANCE vs PRESSURE						
	Pressure (psi)	10	25	50	100	200
	TO-220 Thermal Performance (°C/W)	5.48	5.07	4.52	4.04	3.56
	Thermal Impedance (°C-in²/W) (1)	1.51	1.22	1.07	0.89	0.53
1) The ASTM D5470 test fixture was used. The recorded value includes interfacial thermal resistance. These values are provided for reference only. Actual application performance is directly related to the surface roughness, flatness and pressure applied.						

Typical Applications Include:

- Silicone-sensitive assemblies
- Telecommunications
- Automotive electronics

Configurations Available:

- Sheet form, die-cut parts and roll form
- With or without pressure sensitive adhesive

Building a Part Number

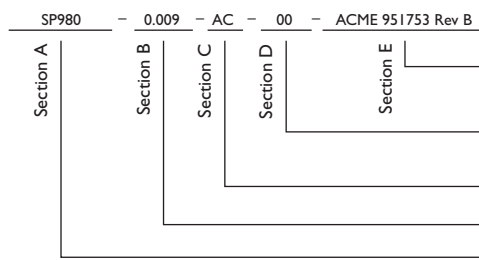

Standard Options

NA = Selected standard option. If not selecting a standard option, insert company name, drawing number, and revision level.

____ = Standard configuration dash number.
 1212 = 12" x 12" sheets, 12/250 = 12" x 250' rolls, or
 00 = custom configuration

AC = Adhesive, one side
 00 = No adhesive

Standard thicknesses available: 0.009"

SP980 = Sil-Pad 980 Material

Note: To build a part number, visit our website at www.bergquistcompany.com.

Sil-Pad®: U.S. Patents 4,574,879; 4,602,125; 4,602,678; 4,685,987; 4,842,911 and others

SIL-PAD

Sil-Pad® I100ST

Affordable, Electrically Insulating, Thermally Conductive, Soft Tack Elastomeric Material

Features and Benefits

- Inherent tack on both sides for exceptional thermal performance and easy placement
- Re-positionable for higher utilization, ease of use and assembly error reduction
- Lined on both sides for ease of handling prior to placement in high volume assemblies
- Exhibits exceptional thermal performance even at a low mounting pressure
- Fiberglass reinforced
- Valve alternative to Sil-Pad I500ST



Sil-Pad I100ST (Soft Tack) is a fiberglass-reinforced thermal interface material featuring inherent tack on both sides. The material exhibits excellent thermal performance at low mounting pressures. The material is supplied on two liners for exceptionally easy handling prior to auto-placement in high-volume assemblies. The material is ideal for placement between an electronic power device and its heat sink.

SIL-PAD

TYPICAL PROPERTIES OF SIL-PAD I100ST						
PROPERTY	IMPERIAL VALUE	METRIC VALUE	TEST METHOD			
Color	Yellow	Yellow	Visual			
Reinforcement Carrier	Fiberglass	Fiberglass	—			
Thickness (inch) / (mm)	0.012	0.305	ASTM D374			
Inherent Surface Tack (1 or 2 sided)	2	2	—			
Hardness (Shore 00) (1)	85	85	ASTM D2240			
Breaking Strength (lb/inch) / (kN/m)	2.6	0.5	ASTM D1458			
Elongation (% - 45° to Warp and Fill)	16	16	ASTM D412			
Tensile Strength (psi) / (MPa)	220	1.5	ASTM D412			
Continuous Use Temp (°F) / (°C)	-76 to 356	-60 to 180	—			
ELECTRICAL						
Dielectric Breakdown Voltage (Vac)	5000	5000	ASTM D149			
Dielectric Constant (1000 Hz)	5.0	5.0	ASTM D150			
Volume Resistivity (Ohm-meter)	10 ¹⁰	10 ¹⁰	ASTM D257			
Flame Rating	V-O	V-O	U.L. 94			
THERMAL						
Thermal Conductivity (W/m-K)	1.1	1.1	ASTM D5470			
THERMAL PERFORMANCE vs. PRESSURE						
	Pressure (psi)	10	25	50	100	200
	TO-220 Thermal Performance (°C/W)	2.72	2.71	2.68	2.62	2.23
	Thermal Impedance (°C-in ² /W) (2)	0.75	0.71	0.66	0.61	0.57

1) Thirty second delay value Shore 00 hardness scale.
 2) The ASTM D5470 test fixture was used. The recorded value includes interfacial thermal resistance. These values are provided for reference only. Actual application performance is directly related to the surface roughness, flatness and pressure applied.

Typical Applications Include:

- Automotive ECMs
- Motor controls
- Power supplies
- Between an electronic power device and its heat sink

Configurations Available:

- Sheet form, die-cut parts and roll form
- Top and bottom liners

Building a Part Number

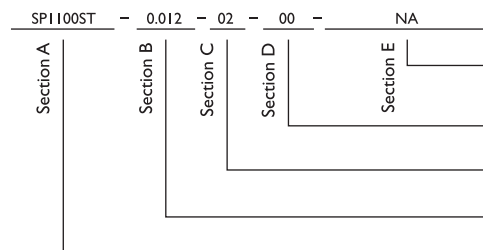

Standard Options

NA = Selected standard option. If not selecting a standard option, insert company name, drawing number, and revision level.

1212 = 12"x12" sheets, 12/250 = 12"x 250" rolls or 00 = custom configuration

02 = Natural tack, both sides

Standard thicknesses available: 0.012"

SPI I100ST = Sil-Pad I100ST Material

Note: To build a part number, visit our website at www.bergquistcompany.com.

Sil-Pad®: U.S. Patents 4,574,879; 4,602,125; 4,602,678; 4,685,987; 4,842,911 and others

Sil-Pad® AI500

Electrically Insulating, Thermally Conductive Elastomeric Material

Features and Benefits

- Thermal impedance: 0.42°C-in²/W (@50 psi)
- Elastomeric compound coated on both sides

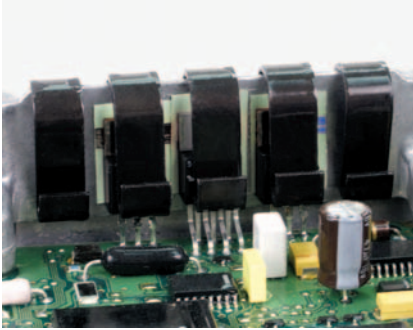

Bergquist Sil-Pad AI500 is a silicone-based, thermally conductive and electrically insulating material. It consists of a cured silicone elastomeric compound coated on both sides of a fiberglass reinforcement layer.

Sil-Pad AI500 performs well under clamping pressure up to 200 psi and is an excellent choice for high performance applications requiring electrical isolation and cut-through resistance.

TYPICAL PROPERTIES OF SIL-PAD AI500						
PROPERTY	IMPERIAL VALUE	METRIC VALUE	TEST METHOD			
Color	Green	Green	Visual			
Reinforcement Carrier	Fiberglass	Fiberglass	—			
Thickness (inch) / (mm)	0.010	0.254	ASTM D374			
Hardness (Shore A)	80	80	ASTM D2240			
Breaking Strength (lbs/inch) / (kN/m)	65	12	ASTM D1458			
Elongation (% - 45° to Warp and Fill)	40	40	ASTM D412			
Continuous Use Temp (°F) / (°C)	-76 to 356	-60 to 180	—			
ELECTRICAL						
Dielectric Breakdown Voltage (Vac)	6000	6000	ASTM D149			
Dielectric Constant (1000 Hz)	7.0	7.0	ASTM D150			
Volume Resistivity (Ohm-meter)	10 ¹¹	10 ¹¹	ASTM D257			
Flame Rating	V-O	V-O	U.L. 94			
THERMAL						
Thermal Conductivity (W/m-K)	2.0	2.0	ASTM D5470			
THERMAL PERFORMANCE vs PRESSURE						
	Pressure (psi)	10	25	50	100	200
TO-220 Thermal Performance (°C/W)		3.03	2.62	2.21	1.92	1.78
Thermal Impedance (°C-in²/W) (I)		0.59	0.50	0.42	0.34	0.31
1) The ASTM D5470 test fixture was used. The recorded value includes interfacial thermal resistance. These values are provided for reference only. Actual application performance is directly related to the surface roughness, flatness and pressure applied.						

Typical Applications Include:

- Power supplies
- Automotive electronics
- Motor controls
- Power semiconductors

Configurations Available:

- Sheet form, die-cut parts, and roll form
- With or without pressure sensitive adhesive

Building a Part Number

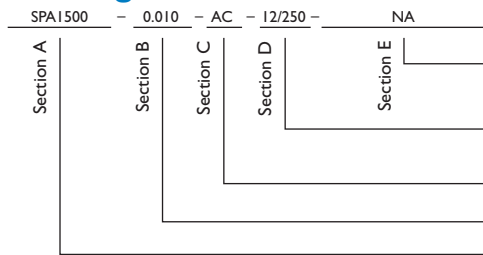

Standard Options

NA = Selected standard option. If not selecting a standard option, insert company name, drawing number, and revision level.

— = Standard configuration dash number, 1212 = 12" x 12" sheets, 12/250 = 12" x 250' rolls, or 00 = custom configuration

AC = Adhesive, one side
00 = No adhesive

Standard thicknesses available: 0.010"

SPA1500 = Sil-Pad AI500 Material

Note: To build a part number, visit our website at www.bergquistcompany.com.

Sil-Pad®: U.S. Patents 4,574,879; 4,602,125; 4,602,678; 4,685,987; 4,842,911 and others

SIL-PAD

Sil-Pad® I500ST

Electrically Insulating, Thermally Conductive, Soft Tack Elastomeric Material

Features and Benefits

- Thermal impedance: 0.23°C-in²/W (@50 psi)
- Naturally tacky on both sides
- Pad is repositionable
- Excellent thermal performance
- Auto-placement and dispensable



Bergquist Sil-Pad I500ST (Soft Tack) is a fiberglass reinforced thermal interface material that is naturally tacky on both sides. Sil-Pad I500ST exhibits superior thermal performance when compared to the competitors' thermal interface materials. Sil-Pad I500ST is supplied in sheet or roll form for exceptional auto-dispensing and auto-placement in high volume assemblies. Sil-Pad I500ST is intended for placement between an electronic power device and its heat sink.

TYPICAL PROPERTIES OF SIL-PAD I500ST						
PROPERTY	IMPERIAL VALUE	METRIC VALUE	TEST METHOD			
Color	Blue	Blue	Visual			
Reinforcement Carrier	Fiberglass	Fiberglass	—			
Thickness (inch) / (mm)	0.008	0.203	ASTM D374			
Hardness (Shore 00)	75	75	ASTM D2240			
Breaking Strength (lbs/inch) / (kN/m)	1.9	0.34	ASTM D1458			
Elongation (% - 45° to Warp and Fill)	22	22	ASTM D412			
Tensile Strength (psi) / (MPa)	238	1.6	ASTM D412			
Continuous Use Temp (°F) / (°C)	-76 to 356	-60 to 180	—			
ELECTRICAL						
Dielectric Breakdown Voltage (Vac)	3000	3000	ASTM D149			
Dielectric Constant (1000 Hz)	6.1	6.1	ASTM D150			
Volume Resistivity (Ohm-meter)	10 ¹¹	10 ¹¹	ASTM D257			
Flame Rating	V-O	V-O	U.L. 94			
THERMAL						
Thermal Conductivity (W/m-K)	1.8	1.8	ASTM D5470			
THERMAL PERFORMANCE vs PRESSURE						
	Pressure (psi)	10	25	50	100	200
	TO-220 Thermal Performance (°C/W)	1.54	1.52	1.51	1.49	1.46
	Thermal Impedance (°C-in ² /W) (1)	0.37	0.28	0.23	0.21	0.20

1) The ASTM D5470 test fixture was used. The recorded value includes interfacial thermal resistance. These values are provided for reference only. Actual application performance is directly related to the surface roughness, flatness and pressure applied.

Typical Applications Include:

- Power supplies
- Automotive electronics
- Motor controls

Configurations Available:

- Sheet form, die-cut parts and slit-to-width roll form
- Also available in 12 mil thickness

Building a Part Number

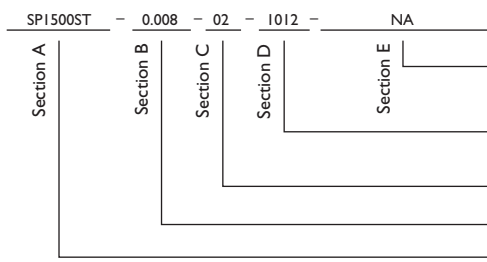

Standard Options

◀ example

NA = Selected standard option. If not selecting a standard option, insert company name, drawing number, and revision level.

— = Standard configuration dash number, I012 = 10" x 12" sheets, I0250 = 10" x 250' rolls (8 mil only), or 00 = custom configuration

02 = Natural tack, both sides

Standard thicknesses available: 0.008", 0.012"

SPI500ST = Sil-Pad I500ST Material

Note: To build a part number, visit our website at www.bergquistcompany.com.

Sil-Pad®: U.S. Patents 4,574,879; 4,602,125; 4,602,678; 4,685,987; 4,842,911 and others

SIL-PAD

Sil-Pad® I750

For High Humidity, High Dielectric (U.L. 94 1950, IEC 950) Requirements

Features and Benefits

- Thermal impedance: 0.53°C-in²/W (@50 psi)
- Excellent dielectric strength retention after humidity exposure
- Elastomeric pad

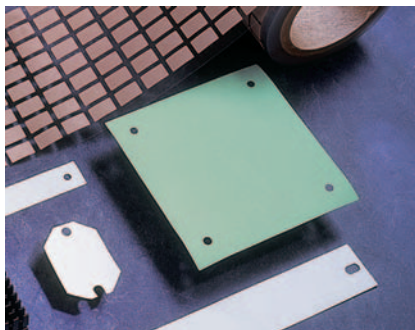

The combination of high thermal conductivity and excellent dielectric strength retention after humidity exposure is formulated into the Sil-Pad I750 elastomeric pad.

Sil-Pad I750 relies on processes that minimize the effect of high humidity on the electrical properties of finished material. Therefore, exposure to humid environments during assembly, or over long-term operating conditions, will not severely affect the ability of the material to perform.

TYPICAL PROPERTIES OF SIL-PAD I750						
PROPERTY	IMPERIAL VALUE	METRIC VALUE	TEST METHOD			
Color	Green	Green	Visual			
Reinforcement Carrier	Fiberglass	Fiberglass	—			
Thickness (inch) / (mm)	0.012	0.305	ASTM D374			
Hardness (Shore A)	85	85	ASTM D2240			
Breaking Strength (lbs/inch) / (kN/m)	65	12	ASTM D1458			
Elongation (% - 45° to Warp and Fill)	23	23	ASTM D412			
Tensile Strength (psi) / (MPa)	1500	10	ASTM D412			
Continuous Use Temp (°F) / (°C)	-76 to 356	-60 to 180	—			
ELECTRICAL						
Dielectric Breakdown Voltage (Vac)	6000	6000	ASTM D149			
Dielectric Constant (1000 Hz)	4.0	4.0	ASTM D150			
Volume Resistivity (Ohm-meter)	10 ¹²	10 ¹²	ASTM D257			
Flame Rating	V-O	V-O	U.L. 94			
THERMAL						
Thermal Conductivity (W/m-K)	2.2	2.2	ASTM D5470			
THERMAL PERFORMANCE vs PRESSURE						
	Pressure (psi)	10	25	50	100	200
TO-220 Thermal Performance (°C/W)		3.11	2.87	2.42	2.08	1.90
Thermal Impedance (°C-in ² /W) (I)		0.86	0.68	0.53	0.39	0.28
<small>I) The ASTM D5470 test fixture was used. The recorded value includes interfacial thermal resistance. These values are provided for reference only. Actual application performance is directly related to the surface roughness, flatness and pressure applied.</small>						

Typical Applications Include:

- High-voltage power supplies
- Motor controls
- High "hi-pot" requirements

Configurations Available:

- Sheet form and die-cut parts
- With or without pressure sensitive adhesive

Building a Part Number

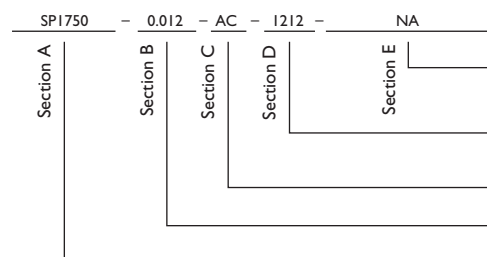

Standard Options

NA = Selected standard option. If not selecting a standard option, insert company name, drawing number, and revision level.

--- = Standard configuration dash number, 1212 = 12" x 12" sheets, or 00 = custom configuration

AC = Adhesive, one side
00 = No adhesive

Standard thicknesses available: 0.012"

SPI750 = Sil-Pad I750 Material

Note: To build a part number, visit our website at www.bergquistcompany.com.

Sil-Pad®: U.S. Patents 4,574,879; 4,602,125; 4,602,678; 4,685,987; 4,842,911 and others

SIL-PAD

Sil-Pad® 2000

Higher Performance, High Reliability Insulator

Features and Benefits

- Thermal impedance: 0.33°C-in²/W (@50 psi)
- Optimal heat transfer
- High thermal conductivity: 3.5 W/m-K



Sil-Pad 2000 is a high performance, thermally conductive insulator designed for demanding military/aerospace and commercial applications. In these applications, Sil-Pad 2000 complies with military standards.

Sil-Pad 2000 is a silicone elastomer formulated to maximize the thermal and dielectric performance of the filler/binder matrix. The result is a grease-free, conformable material capable of meeting or exceeding the thermal and electrical requirements of high-reliability electronic packaging applications.

TYPICAL PROPERTIES OF SIL-PAD 2000						
PROPERTY	IMPERIAL VALUE	METRIC VALUE	TEST METHOD			
Color	White	White	Visual			
Reinforcement Carrier	Fiberglass	Fiberglass	—			
Thickness (inch) / (mm)	0.010 to 0.015	0.254 to 0.381	ASTM D374			
Hardness (Shore A)	90	90	ASTM D2240			
Continuous Use Temp (°F) / (°C)	-76 to 392	-60 to 200	—			
ELECTRICAL						
Dielectric Breakdown Voltage (Vac)	4000	4000	ASTM D149			
Dielectric Constant (1000 Hz)	4.0	4.0	ASTM D150			
Volume Resistivity (Ohm-meter)	10 ¹¹	10 ¹¹	ASTM D257			
Flame Rating	V-O	V-O	UL94			
THERMAL						
Thermal Conductivity (W/m-K)	3.5	3.5	ASTM D5470			
THERMAL PERFORMANCE vs PRESSURE						
	Pressure (psi)	10	25	50	100	200
	TO-220 Thermal Performance (°C/W)	2.61	2.32	2.02	1.65	1.37
	Thermal Impedance (°C-in²/W) (1)	0.57	0.43	0.33	0.25	0.20

1) The ASTM D5470 test fixture was used. The recorded value includes interfacial thermal resistance. These values are provided for reference only. Actual application performance is directly related to the surface roughness, flatness and pressure applied.

Typical Applications Include:

- Power supplies
- Power semiconductors
- CAGE Number 55285
- Aerospace
- Motor controls
- U.L. File Number E59150
- Military Electronics
- Avionics

Configurations Available:

- Sheet form, die-cut parts and roll form
- With or without pressure sensitive adhesive

SIL-PAD

Outgassing Data for Spacecraft Materials		
Post Cure Conditions	%TML (1.0% Max. Acceptable)	%CVCM (0.1% Max. Acceptable)
24 hrs. @ 175°C	0.07	0.03
No Post Cure	0.26	0.10

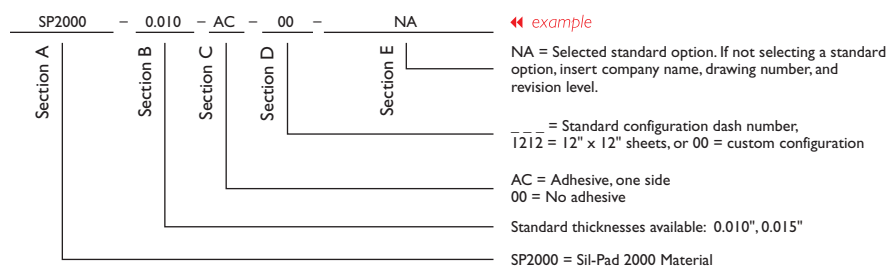

Note: To build a part number, visit our website at www.bergquistcompany.com.

Building a Part Number Standard Options

Sil-Pad®: U.S. Patents 4,574,879; 4,602,125; 4,602,678; 4,685,987; 4,842,911 and others

Sil-Pad® A2000

Higher Performance, High Reliability Insulator

Features and Benefits

- Thermal impedance: 0.32°C-in²/W (@50 psi)
- Optimal heat transfer
- High thermal conductivity: 3.0 W/m-K

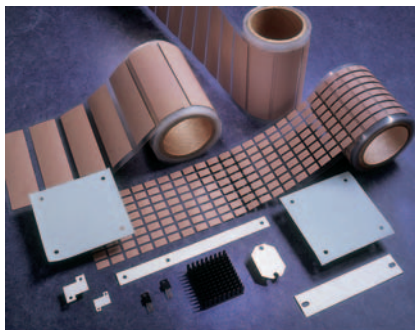

Sil-Pad A2000 is a conformable elastomer with very high thermal conductivity that acts as a thermal interface between electrical components and heat sinks. Sil-Pad A2000 is for applications where optimal heat transfer is a requirement.

This thermally conductive silicone elastomer is formulated to maximize the thermal and dielectric performance of the filler/binder matrix. The result is a grease-free, conformable material capable of meeting or exceeding the thermal and electrical requirements of high reliability electronic packaging applications.

TYPICAL PROPERTIES OF SIL-PAD A2000						
PROPERTY	IMPERIAL VALUE	METRIC VALUE	TEST METHOD			
Color	White	White	Visual			
Reinforcement Carrier	Fiberglass	Fiberglass	—			
Thickness (inch) / (mm)	0.015 to 0.020	0.381 to 0.508	ASTM D374			
Hardness (Shore A)	90	90	ASTM D2240			
Heat Capacity (J/g-K)	1.0	1.0	ASTM E1269			
Continuous Use Temp (°F) / (°C)	-76 to 392	-60 to 200	—			
ELECTRICAL						
Dielectric Breakdown Voltage (Vac)	4000	4000	ASTM D149			
Dielectric Constant (1000 Hz)	7.0	7.0	ASTM D150			
Volume Resistivity (Ohm-meter)	10 ¹¹	10 ¹¹	ASTM D257			
Flame Rating	V-O	V-O	UL94			
THERMAL						
Thermal Conductivity (W/m-K)	3.0	3.0	ASTM D5470			
THERMAL PERFORMANCE vs PRESSURE						
	Pressure (psi)	10	25	50	100	200
TO-220 Thermal Performance (°C/W) 0.015"		2.05	1.94	1.86	1.79	1.72
Thermal Impedance (°C-in²/W) 0.015" (1)		0.53	0.40	0.32	0.28	0.26
1) The ASTM D5470 test fixture was used. The recorded value includes interfacial thermal resistance. These values are provided for reference only. Actual application performance is directly related to the surface roughness, flatness and pressure applied.						

Typical Applications Include:

- Motor drive controls
- Avionics
- High-voltage power supplies
- Power transistor / heat sink interface

Configurations Available:

- Sheet form, die-cut parts and roll form
- With or without pressure sensitive adhesive

Building a Part Number

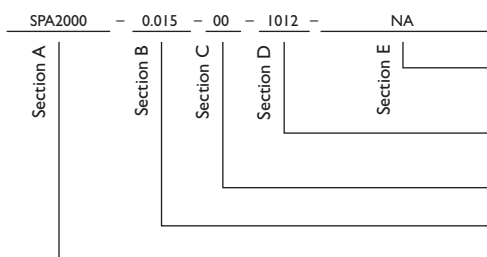

Standard Options

◀ example

NA = Selected standard option. If not selecting a standard option, insert company name, drawing number, and revision level.

— = Standard configuration dash number, 1012 = 10" x 12" sheets, 10/250 = 10" x 250' rolls, or 00 = custom configuration

AC = Adhesive, one side
00 = No adhesive

Standard thicknesses available: 0.015", 0.020"

SPA2000 = Sil-Pad A2000 Material

Note: To build a part number, visit our website at www.bergquistcompany.com.

Sil-Pad®. U.S. Patents 4,574,879; 4,602,125; 4,602,678; 4,685,987; 4,842,911 and others

SIL-PAD

Sil-Pad® K-4

The Original Kapton®-Based Insulator

Features and Benefits

- Thermal impedance: 0.48°C-in²/W (@50 psi)
- Withstands high voltages
- High dielectric strength
- Very durable

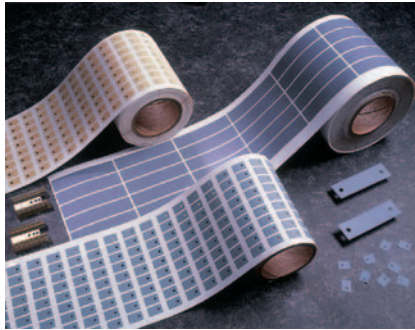

Sil-Pad K-4 uses a specially developed film which has high thermal conductivity, high dielectric strength and is very durable. Sil-Pad K-4 combines the thermal transfer properties of well-known Sil-Pad rubber with the physical properties of a film.

Sil-Pad K-4 is a durable insulator that withstands high voltages and requires no thermal grease to transfer heat. Sil-Pad K-4 is available in customized shapes and sizes.

TYPICAL PROPERTIES OF SIL-PAD K-4						
PROPERTY	IMPERIAL VALUE	METRIC VALUE	TEST METHOD			
Color	Gray	Gray	Visual			
Reinforcement Carrier	Kapton	Kapton	—			
Thickness (inch) / (mm)	0.006	0.152	ASTM D374			
Hardness (Shore A)	90	90	ASTM D2240			
Breaking Strength (lbs/inch) / (kN/m)	30	5	ASTM D1458			
Elongation (%)	40	40	ASTM D412			
Tensile Strength (psi) / (MPa)	5000	34	ASTM D412			
Continuous Use Temp (°F) / (°C)	-76 to 356	-60 to 180	—			
ELECTRICAL						
Dielectric Breakdown Voltage (Vac)	6000	6000	ASTM D149			
Dielectric Constant (1000 Hz)	5.0	5.0	ASTM D150			
Volume Resistivity (Ohm-meter)	10 ¹²	10 ¹²	ASTM D257			
Flame Rating	VTM-O	VTM-O	UL94			
THERMAL						
Thermal Conductivity (W/m-K)	0.9	0.9	ASTM D5470			
THERMAL PERFORMANCE vs PRESSURE						
	Pressure (psi)	10	25	50	100	200
	TO-220 Thermal Performance (°C/W)	3.66	3.43	3.13	2.74	2.42
	Thermal Impedance (°C-in ² /W) (1)	1.07	0.68	0.48	0.42	0.38

1) The ASTM D5470 test fixture was used. The recorded value includes interfacial thermal resistance. These values are provided for reference only. Actual application performance is directly related to the surface roughness, flatness and pressure applied.

Typical Applications Include:

- Power supplies
- Power semiconductors
- Motor controls
- CAGE Number 55285

Configurations Available:

- Sheet form, die-cut parts and roll form
- With or without pressure sensitive adhesive

Building a Part Number

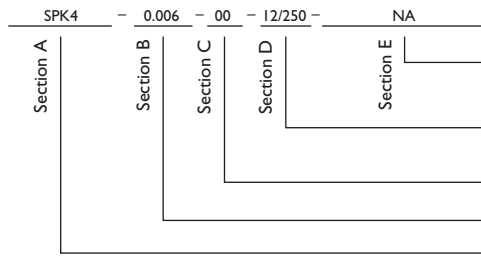

Standard Options

◀ example
 NA = Selected standard option. If not selecting a standard option, insert company name, drawing number, and revision level.
 --- = Standard configuration dash number, 1212 = 12" x 12" sheets, 12/250 = 12" x 250" rolls, or 00 = custom configuration
 AC = Adhesive, one side
 00 = No adhesive
 Standard thicknesses available: 0.006"
 SPK4 = Sil-Pad K4 Material

Note: To build a part number, visit our website at www.bergquistcompany.com.

Sil-Pad®: U.S. Patents 4,574,879; 4,602,125; 4,602,678; 4,685,987; 4,842,911 and others.
 Kapton® is a registered trademark of DuPont.

SIL-PAD

Sil-Pad® K-6

The Medium Performance Kapton®-Based Insulator

Features and Benefits

- Thermal impedance: 0.49°C-in²/W (@50 psi)
- Physically strong dielectric barrier against cut-through
- Medium performance film

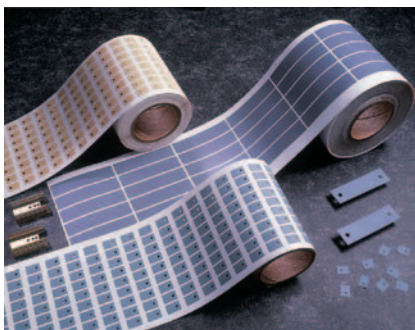

Sil-Pad K-6 is a medium performance, film-based thermally conductive insulator. The film is coated with a silicone elastomer to deliver high performance and provide a continuous, physically strong dielectric barrier against "cut-through" and resultant assembly failures.

TYPICAL PROPERTIES OF SIL-PAD K-6						
PROPERTY	IMPERIAL VALUE	METRIC VALUE	TEST METHOD			
Color	Bluegreen	Bluegreen	Visual			
Reinforcement Carrier	Kapton	Kapton	—			
Thickness (inch) / (mm)	0.006	0.152	ASTM D374			
Hardness (Shore A)	90	90	ASTM D2240			
Breaking Strength (lbs/inch) / (kN/m)	30	5	ASTM D1458			
Elongation (%)	40	40	ASTM D412			
Tensile Strength (psi) / (MPa)	5000	34	ASTM D412			
Continuous Use Temp (°F) / (°C)	-76 to 356	-60 to 180	—			
ELECTRICAL						
Dielectric Breakdown Voltage (Vac)	6000	6000	ASTM D149			
Dielectric Constant (1000 Hz)	4.0	4.0	ASTM D150			
Volume Resistivity (Ohm-meter)	10 ¹²	10 ¹²	ASTM D257			
Flame Rating	VTM-O	VTM-O	UL94			
THERMAL						
Thermal Conductivity (W/m-K)	1.1	1.1	ASTM D5470			
THERMAL PERFORMANCE vs PRESSURE						
	Pressure (psi)	10	25	50	100	200
	TO-220 Thermal Performance (°C/W)	3.24	3.03	2.76	2.45	2.24
	Thermal Impedance (°C-in ² /W) (I)	0.82	0.62	0.49	0.41	0.36

1) The ASTM D5470 test fixture was used. The recorded value includes interfacial thermal resistance. These values are provided for reference only. Actual application performance is directly related to the surface roughness, flatness and pressure applied.

Typical Applications Include:

- Power supplies
- Power semiconductors
- Motor controls
- CAGE Number 55285

Configurations Available:

- Sheet form, die-cut parts and roll form
- With or without pressure sensitive adhesive

Building a Part Number

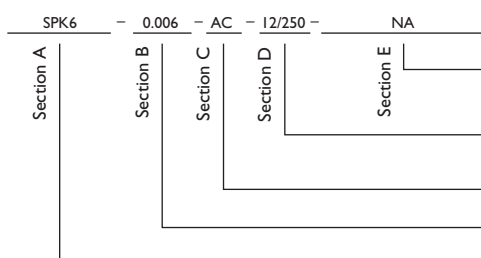

Standard Options

◀ example

NA = Selected standard option. If not selecting a standard option, insert company name, drawing number, and revision level.

--- = Standard configuration dash number, 1212 = 12" x 12" sheets, 12/250 = 12" x 250" rolls, or 00 = custom configuration

AC = Adhesive, one side
00 = No adhesive

Standard thicknesses available: 0.006"

SPK6 = Sil-Pad K6 Material

Note: To build a part number, visit our website at www.bergquistcompany.com.

Sil-Pad®: U.S. Patents 4,574,879; 4,602,125; 4,602,678; 4,685,987; 4,842,911 and others

Kapton® is a registered trademark of DuPont.

SIL-PAD

Sil-Pad® K-10

The High Performance Kapton®-Based Insulator

Features and Benefits

- Thermal impedance: 0.41 °C-in²/W (@50 psi)
- Tough dielectric barrier against cut-through
- High performance film
- Designed to replace ceramic insulators

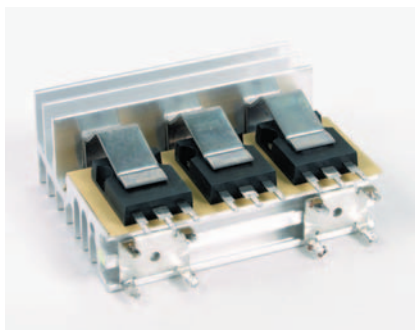

Sil-Pad K-10 is a high performance insulator. It combines special film with a filled silicone rubber. The result is a product with good cut-through properties and excellent thermal performance.

Sil-Pad K-10 is designed to replace ceramic insulators such as Beryllium Oxide, Boron Nitride and Alumina. Ceramic insulators are expensive and they break easily. Sil-Pad K-10 eliminates breakage and costs much less than ceramics.

TYPICAL PROPERTIES OF SIL-PAD K-10						
PROPERTY	IMPERIAL VALUE	METRIC VALUE	TEST METHOD			
Color	Beige	Beige	Visual			
Reinforcement Carrier	Kapton	Kapton	—			
Thickness (inch) / (mm)	0.006	0.152	ASTM D374			
Hardness (Shore A)	90	90	ASTM D2240			
Breaking Strength (lbs/inch) / (kN/m)	30	5	ASTM D1458			
Elongation (%)	40	40	ASTM D412			
Tensile Strength (psi) / (MPa)	5000	34	ASTM D412			
Continuous Use Temp (°F) / (°C)	-76 to 356	-60 to 180	—			
ELECTRICAL						
Dielectric Breakdown Voltage (Vac)	6000	6000	ASTM D149			
Dielectric Constant (1000 Hz)	3.7	3.7	ASTM D150			
Volume Resistivity (Ohm-meter)	10 ¹²	10 ¹²	ASTM D257			
Flame Rating	VTM-O	VTM-O	UL94			
THERMAL						
Thermal Conductivity (W/m-K)	1.3	1.3	ASTM D5470			
THERMAL PERFORMANCE vs PRESSURE						
	Pressure (psi)	10	25	50	100	200
TO-220 Thermal Performance (°C/W)		2.35	2.19	2.01	1.87	1.76
Thermal Impedance (°C-in ² /W) (1)		0.86	0.56	0.41	0.29	0.24

1) The ASTM D5470 test fixture was used. The recorded value includes interfacial thermal resistance. These values are provided for reference only. Actual application performance is directly related to the surface roughness, flatness and pressure applied.

Typical Applications Include:

- Power supplies
- Motor controls
- Power semiconductors
- CAGE Number 55285

Configurations Available:

- Sheet form, die-cut parts and roll form
- With or without pressure sensitive adhesive

Building a Part Number

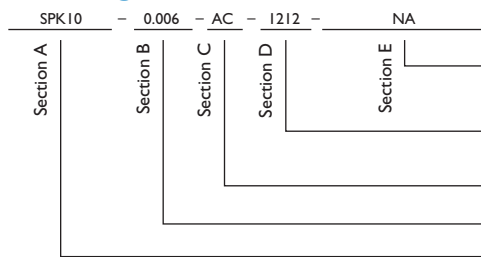

Standard Options

NA = Selected standard option. If not selecting a standard option, insert company name, drawing number, and revision level.

— = Standard configuration dash number, 1212 = 12" x 12" sheets, 12/250 = 12" x 250' rolls, or 00 = custom configuration

AC = Adhesive, one side
00 = No adhesive

Standard thicknesses available: 0.006"

SPK10 = Sil-Pad K10 Material

Note: To build a part number, visit our website at www.bergquistcompany.com.

Sil-Pad®: U.S. Patents 4,574,879; 4,602,125; 4,602,678; 4,685,987; 4,842,911 and others.

Kapton® is a registered trademark of DuPont.

SIL-PAD

Q-Pad® II

Foil-Format Grease Replacement for Maximum Heat Transfer

Features and Benefits

- Thermal impedance: 0.22°C-in²/W (@50 psi)
- Maximum heat transfer
- Aluminum foil coated both sides
- Designed to replace thermal grease



Q-Pad II is a composite of aluminum foil coated on both sides with thermally / electrically conductive Sil-Pad rubber. The material is designed for those applications in which maximum heat transfer is needed and electrical isolation is not required. Q-Pad II is the ideal thermal interface material to replace messy thermal grease compounds.

Q-Pad II eliminates problems associated with grease such as contamination of reflow solder or cleaning operations. Unlike grease, Q-Pad II can be used prior to these operations. Q-Pad II also eliminates dust collection which can cause possible surface shorting or heat buildup.

TYPICAL PROPERTIES OF Q-PAD II						
PROPERTY	IMPERIAL VALUE	METRIC VALUE	TEST METHOD			
Color	Black	Black	Visual			
Reinforcement Carrier	Aluminum	Aluminum	—			
Thickness (inch) / (mm)	0.006	0.152	ASTM D374			
Hardness (Shore A)	93	93	ASTM D2240			
Continuous Use Temp (°F) / (°C)	-76 to 356	-60 to 180	—			
ELECTRICAL						
Dielectric Breakdown Voltage (Vac)	Non-Insulating	Non-Insulating	ASTM D149			
Dielectric Constant (1000 Hz)	NA	NA	ASTM D150			
Volume Resistivity (Ohm-meter)	10 ²	10 ²	ASTM D257			
Flame Rating	V-O	V-O	UL94			
THERMAL						
Thermal Conductivity (W/m-K)	2.5	2.5	ASTM D5470			
THERMAL PERFORMANCE vs PRESSURE						
	Pressure (psi)	10	25	50	100	200
TO-220 Thermal Performance (°C/W)		2.44	1.73	1.23	1.05	0.92
Thermal Impedance (°C-in²/W) (I)		0.52	0.30	0.22	0.15	0.12

1) The ASTM D5470 test fixture was used. The recorded value includes interfacial thermal resistance. These values are provided for reference only. Actual application performance is directly related to the surface roughness, flatness and pressure applied.

Typical Applications Include:

- Between a transistor and a heat sink
- Between two large surfaces such as an L-bracket and the chassis of an assembly
- Between a heat sink and a chassis
- Under electrically isolated power modules or devices such as resistors, transformers and solid state relays

Configurations Available:

- Sheet form, die-cut parts and roll form
- With or without pressure sensitive adhesive

Building a Part Number

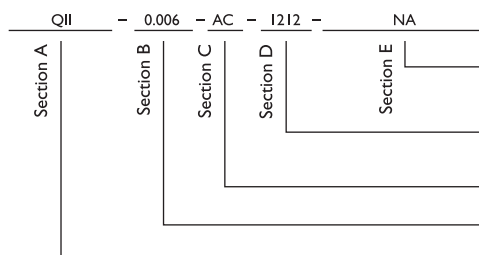

Standard Options

◀ example
 NA = Selected standard option. If not selecting a standard option, insert company name, drawing number, and revision level.
 --- = Standard configuration dash number, I212 = 12" x 12" sheets, I2/250 = 12" x 250' rolls, or 00 = custom configuration
 AC = Adhesive, one side
 00 = No adhesive
 Standard thicknesses available: 0.006"
 QII = Q-Pad II Material

Note: To build a part number, visit our website at www.bergquistcompany.com.

Sil-Pad®: U.S. Patents 4,574,879; 4,602,125; 4,602,678; 4,685,987; 4,842,911 and others

SIL-PAD

Q-Pad® 3

Glass-Reinforced Grease Replacement Thermal Interface

Features and Benefits

- Thermal impedance: 0.35°C-in²/W (@50 psi)
- Eliminates processing constraints typically associated with grease
- Conforms to surface textures
- Easy handling
- May be installed prior to soldering and cleaning without worry

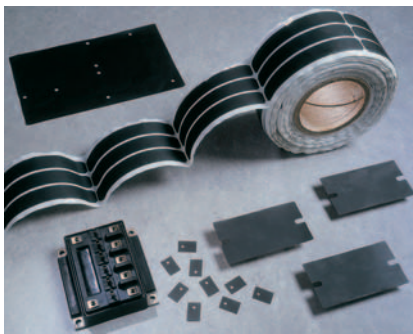

Bergquist Q-Pad 3 eliminates problems associated with thermal grease such as contamination of electronic assemblies and reflow solder baths. Q-Pad 3 may be installed prior to soldering and cleaning without worry. When clamped between two surfaces, the elastomer conforms to surface textures thereby creating an air-free interface between heat-generating components and heat sinks.

Fiberglass reinforcement enables Q-Pad 3 to withstand processing stresses without losing physical integrity. It also provides ease of handling during application.

TYPICAL PROPERTIES OF Q-PAD 3						
PROPERTY	IMPERIAL VALUE	METRIC VALUE	TEST METHOD			
Color	Black	Black	Visual			
Reinforcement Carrier	Fiberglass	Fiberglass	—			
Thickness (inch) / (mm)	0.005	0.127	ASTM D374			
Hardness (Shore A)	86	86	ASTM D2240			
Continuous Use Temp (°F) / (°C)	-76 to 356	-60 to 180	—			
ELECTRICAL						
Dielectric Breakdown Voltage (Vac)	Non-Insulating	Non-Insulating	ASTM D149			
Dielectric Constant (1000 Hz)	NA	NA	ASTM D150			
Volume Resistivity (Ohm-meter)	10 ²	10 ²	ASTM D257			
Flame Rating	V-O	V-O	UL94			
THERMAL						
Thermal Conductivity (W/m-K)	2.0	2.0	ASTM D5470			
THERMAL PERFORMANCE vs PRESSURE						
	Pressure (psi)	10	25	50	100	200
	TO-220 Thermal Performance (°C/W)	2.26	1.99	1.76	1.53	1.30
	Thermal Impedance (°C-in²/W) (1)	0.65	0.48	0.35	0.24	0.16

1) The ASTM D5470 test fixture was used. The recorded value includes interfacial thermal resistance. These values are provided for reference only. Actual application performance is directly related to the surface roughness, flatness and pressure applied.

Typical Applications Include:

- Between a transistor and a heat sink
- Between two large surfaces such as an L-bracket and the chassis of an assembly
- Between a heat sink and a chassis
- Under electrically isolated power modules or devices such as resistors, transformers and solid state relays

Configurations Available:

- Sheet form, die-cut parts and roll form
- With or without pressure sensitive adhesive

Building a Part Number

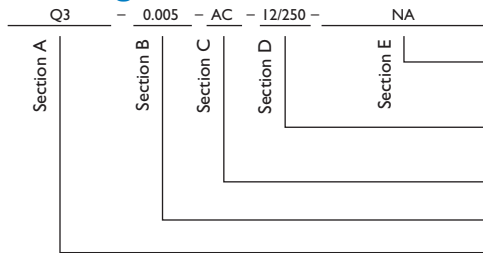

Standard Options

NA = Selected standard option. If not selecting a standard option, insert company name, drawing number, and revision level.

--- = Standard configuration dash number, 1212 = 12" x 12" sheets, 12/250 = 12" x 250' rolls, or 00 = custom configuration

AC = Adhesive, one side
00 = No adhesive

Standard thicknesses available: 0.005"

Q3 = Q-Pad 3 Material

Note: To build a part number, visit our website at www.bergquistcompany.com.

Sil-Pad®: U.S. Patents 4,574,879; 4,602,125; 4,602,678; 4,685,987; 4,842,911 and others

SIL-PAD

Poly-Pad® 400

Polyester-Based, Thermally Conductive Insulation Material

Features and Benefits

- Thermal impedance: 1.13°C-in²/W (@50 psi)
- Polyester based
- For applications requiring conformal coatings
- Designed for silicone-sensitive standard applications



Poly-Pad 400 is a fiberglass-reinforced insulator coated with a filled polyester resin. Poly-Pad 400 is economical and designed for most standard applications.

Polyester-based, thermally conductive insulators from Bergquist provide a complete family of materials for silicone-sensitive applications. Poly-Pads are ideally suited for applications requiring conformal coatings or applications where silicone contamination is a concern (telecomm and certain aerospace applications). Poly-Pads are constructed with ceramic-filled polyester resins coating either side of a fiberglass carrier or a film carrier. The Poly-Pad family offers a complete range of performance characteristics to match individual applications.

TYPICAL PROPERTIES OF POLY-PAD 400						
PROPERTY	IMPERIAL VALUE	METRIC VALUE	TEST METHOD			
Color	Tan	Tan	Visual			
Reinforcement Carrier	Fiberglass	Fiberglass	—			
Thickness (inch) / (mm)	0.009	0.229	ASTM D374			
Hardness (Shore A)	90	90	ASTM D2240			
Breaking Strength (lbs/inch)/(kN/m)	100	18	ASTM D1458			
Elongation(% - 45° to Warp and Fill)	10	10	ASTM D412			
Tensile Strength (psi) / (MPa)	7000	48	ASTM D412			
Continuous Use Temp (°F) / (°C)	-4 to 302	-20 to 150	—			
ELECTRICAL						
Dielectric Breakdown Voltage (Vac)	2500	2500	ASTM D149			
Dielectric Constant (1000 Hz)	5.5	5.5	ASTM D150			
Volume Resistivity (Ohm-meter)	10 ¹¹	10 ¹¹	ASTM D257			
THERMAL						
Thermal Conductivity (W/m-K)	0.9	0.9	ASTM D5470			
Flame Rating	V-O	V-O	U.L. 94			
THERMAL PERFORMANCE vs PRESSURE						
	Pressure (psi)	10	25	50	100	200
TO-220 Thermal Performance (°C/W)		5.85	5.61	5.13	4.59	4.12
Thermal Impedance (°C-in ² /W) (1)		1.62	1.35	1.13	0.86	0.61

1) The ASTM D5470 test fixture was used. The recorded value includes interfacial thermal resistance. These values are provided for reference only. Actual application performance is directly related to the surface roughness, flatness and pressure applied.

Typical Applications Include:

- Power supplies
- Automotive electronics
- Motor controls
- Power semiconductors

Configurations Available:

- Sheet form, die-cut parts and roll form
- With or without pressure sensitive adhesive
- We produce thousands of specials. Tooling charges vary depending on tolerances and the complexity of the part.

Building a Part Number

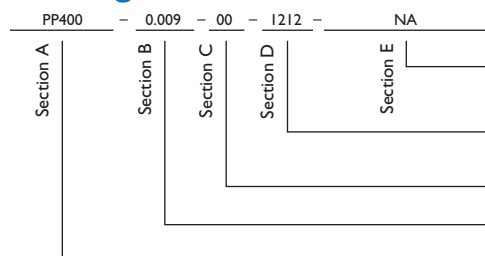

Standard Options

◀ example
 NA = Selected standard option. If not selecting a standard option, insert company name, drawing number, and revision level.
 ___ = Standard configuration dash number, 1212 = 12" x 12" sheets, 12/250 = 12" x 250' rolls, or 00 = custom configuration
 AC = Adhesive, one side
 00 = No adhesive
 Standard thicknesses available: 0.009"
 PP400 = Poly-Pad 400 Material

Note: To build a part number, visit our website at www.bergquistcompany.com.

Sil-Pad®: U.S. Patents 4,574,879; 4,602,125; 4,602,678; 4,685,987; 4,842,911 and others

SIL-PAD

Poly-Pad[®] 1000

Polyester-Based, Thermally Conductive Insulation Material

Features and Benefits

- Thermal impedance: 0.82°C-in²/W (@50 psi)
- Polyester based
- For applications requiring non-silicone conformal coatings
- Designed for silicone-sensitive applications requiring high performance



Poly-Pad 1000 is a fiberglass-reinforced insulator coated with a filled polyester resin. The material offers superior thermal resistance for high performance applications.

Polyester-based, thermally conductive insulators from Bergquist provide a complete family of materials for silicone-sensitive applications. Poly-Pads are ideally suited for applications requiring conformal coatings or applications where silicone contamination is a concern (telecomm and certain aerospace applications). Poly-Pads are constructed with ceramic-filled polyester resins coating either side of a fiberglass carrier or a film carrier. The Poly-Pad family offers a complete range of performance characteristics to match individual applications.

SIL-PAD

TYPICAL PROPERTIES OF POLY-PAD 1000						
PROPERTY	IMPERIAL VALUE	METRIC VALUE	TEST METHOD			
Color	Yellow	Yellow	Visual			
Reinforcement Carrier	Fiberglass	Fiberglass	—			
Thickness (inch) / (mm)	0.009	0.229	ASTM D374			
Hardness (Shore A)	90	90	ASTM D2240			
Breaking Strength (lbs/inch) / (kN/m)	100	18	ASTM D1458			
Elongation (%)	10	10	ASTM D412			
Tensile Strength (psi) / (MPa)	7000	48	ASTM D412			
Continuous Use Temp (°F) / (°C)	-4 to 302	-20 to 150	—			
ELECTRICAL						
Dielectric Breakdown Voltage (Vac)	2500	2500	ASTM D149			
Dielectric Constant (1000 Hz)	4.5	4.5	ASTM D150			
Volume Resistivity (Ohm-meter)	10 ¹¹	10 ¹¹	ASTM D257			
THERMAL						
Thermal Conductivity (W/m-K)	1.2	1.2	ASTM D5470			
THERMAL PERFORMANCE vs PRESSURE						
	Pressure (psi)	10	25	50	100	200
TO-220 Thermal Performance (°C/W)		4.70	4.25	3.74	3.27	2.89
Thermal Impedance (°C-in ² /W) (1)		1.30	1.02	0.82	0.61	0.43

1) The ASTM D5470 test fixture was used. The recorded value includes interfacial thermal resistance. These values are provided for reference only. Actual application performance is directly related to the surface roughness, flatness and pressure applied.

Typical Applications Include:

- Power supplies
- Automotive electronics
- Motor controls
- Power semiconductors

Configurations Available:

- Sheet form, die-cut parts and roll form
- With or without pressure sensitive adhesive

Building a Part Number

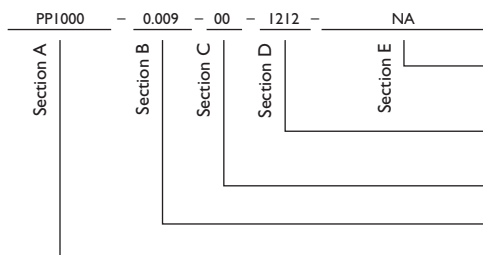

Standard Options

NA = Selected standard option. If not selecting a standard option, insert company name, drawing number, and revision level.

1212 = Standard configuration dash number.
1212 = 12" x 12" sheets, 12/250 = 12" x 250' rolls, or 00 = custom configuration

AC = Adhesive, one side
00 = No adhesive

Standard thicknesses available: 0.009"

PP1000 = Poly-Pad 1000 Material

Note: To build a part number, visit our website at www.bergquistcompany.com.

Sil-Pad[®]: U.S. Patents 4,574,879; 4,602,125; 4,602,678; 4,685,987; 4,842,911 and others

Poly-Pad® K-4

Polyester-Based, Thermally Conductive Insulation Material

Features and Benefits

- Thermal impedance: 0.95°C-in²/W (@50 psi)
- Polyester based
- For applications requiring non-silicone conformal coatings
- Designed for silicone-sensitive applications
- Excellent dielectric and physical strength



Poly-Pad K-4 is a composite of film coated with a polyester resin. The material is an economical insulator and the film carrier provides excellent dielectric and physical strength.

Polyester-based, thermally conductive insulators from Bergquist provide a complete family of materials for silicone-sensitive applications. Poly-Pads are ideally suited for applications requiring conformal coatings or applications where silicone contamination is a concern (telecomm and certain aerospace applications). Poly-Pads are constructed with ceramic-filled polyester resins coating either side of a fiberglass carrier or a film carrier. The Poly-Pad family offers a complete range of performance characteristics to match individual applications.

TYPICAL PROPERTIES OF POLY-PAD K-4						
PROPERTY	IMPERIAL VALUE	METRIC VALUE	TEST METHOD			
Color	Tan	Tan	Visual			
Reinforcement Carrier	Kapton	Kapton	—			
Thickness (inch) / (mm)	0.006	0.152	ASTM D374			
Hardness (Shore A)	90	90	ASTM D2240			
Breaking Strength (lbs/inch) / (kN/m)	30	5	ASTM D1458			
Elongation (%)	40	40	ASTM D412			
Tensile Strength (psi) / (MPa)	5000	34	ASTM D412			
Continuous Use Temp (°F) / (°C)	-4 to 302	-20 to 150	—			
ELECTRICAL						
Dielectric Breakdown Voltage (Vac)	6000	6000	ASTM D149			
Dielectric Constant (1000 Hz)	5.0	5.0	ASTM D150			
Volume Resistivity (Ohm-meter)	10 ¹²	10 ¹²	ASTM D257			
Flame Rating	V-O	V-O	UL94			
THERMAL						
Thermal Conductivity (W/m-K)	0.9	0.9	ASTM D5470			
THERMAL PERFORMANCE vs PRESSURE						
	Pressure (psi)	10	25	50	100	200
	TO-220 Thermal Performance (°C/W)	5.64	5.04	4.34	3.69	3.12
	Thermal Impedance (°C-in ² /W) (I)	1.55	1.21	0.95	0.70	0.46

I) The ASTM D5470 test fixture was used. The recorded value includes interfacial thermal resistance. These values are provided for reference only. Actual application performance is directly related to the surface roughness, flatness and pressure applied.

Typical Applications Include:

- Power supplies
- Motor controls
- Power semiconductors

Configurations Available:

- Sheet form, die-cut parts and roll form
- With or without pressure sensitive adhesive

Building a Part Number

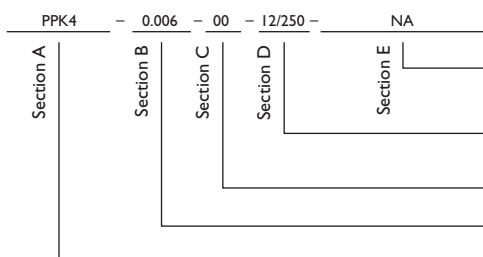

Standard Options

NA = Selected standard option. If not selecting a standard option, insert company name, drawing number, and revision level.
 --- = Standard configuration dash number, 1212 = 12" x 12" sheets, 12/250 = 12" x 250" rolls, or 00 = custom configuration
 AC = Adhesive, one side
 00 = No adhesive
 Standard thicknesses available: 0.006"
 PPK4 = Poly-Pad K-4 Material

Note: To build a part number, visit our website at www.bergquistcompany.com.

Sil-Pad®: U.S. Patents 4,574,879; 4,602,125; 4,602,678; 4,685,987; 4,842,911 and others

Kapton® is a registered trademark of DuPont.

SIL-PAD

Poly-Pad® K-10

Polyester-Based, Thermally Conductive Insulation Material

Features and Benefits

- Thermal impedance: 0.60°C-in²/W (@50 psi)
- Polyester based
- For applications requiring non-silicone conformal coatings
- Designed for silicone-sensitive applications
- Excellent dielectric strength and thermal performance

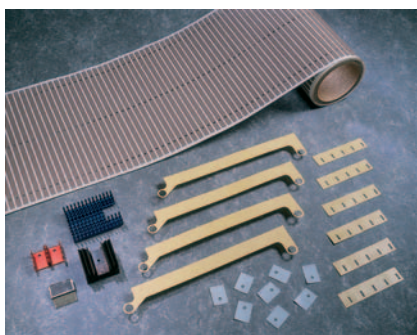

Poly-Pad K-10 is a composite of film coated with a polyester resin. The material offers superior thermal performance for your most critical applications with a thermal resistance of 0.2°C-in²/W as well as excellent dielectric strength.

Polyester-based, thermally conductive insulators from Bergquist provide a complete family of materials for silicone-sensitive applications. Poly-Pads are ideally suited for applications requiring conformal coatings or applications where silicone contamination is a concern (telecomm and certain aerospace applications). Poly-Pads are constructed with ceramic-filled polyester resins coating either side of a fiber-glass carrier or a film carrier. The Poly-Pad family offers a complete range of performance characteristics to match individual applications.

TYPICAL PROPERTIES OF POLY-PAD K-10						
PROPERTY	IMPERIAL VALUE	METRIC VALUE	TEST METHOD			
Color	Yellow	Yellow	Visual			
Reinforcement Carrier	Kapton	Kapton	—			
Thickness (inch) / (mm)	0.006	0.152	ASTM D374			
Hardness (Shore A)	90	90	ASTM D2240			
Breaking Strength (lbs/inch) / (kN/m)	30	5	ASTM D1458			
Elongation (%)	40	40	ASTM D412			
Tensile Strength (psi) / (MPa)	5000	34	ASTM D412			
Continuous Use Temp (°F) / (°C)	-4 to 302	-20 to 150	—			
ELECTRICAL						
Dielectric Breakdown Voltage (Vac)	6000	6000	ASTM D149			
Dielectric Constant (1000 Hz)	3.7	3.7	ASTM D150			
Volume Resistivity (Ohm-meter)	10 ¹²	10 ¹²	ASTM D257			
Flame Rating	V-O	V-O	UL94			
THERMAL						
Thermal Conductivity (W/m-K)	1.3	1.3	ASTM D5470			
THERMAL PERFORMANCE vs PRESSURE						
	Pressure (psi)	10	25	50	100	200
	TO-220 Thermal Performance (°C/W)	3.76	3.35	2.75	2.30	2.03
	Thermal Impedance (°C-in ² /W) (1)	1.04	0.80	0.60	0.43	0.30

1) The ASTM D5470 test fixture was used. The recorded value includes interfacial thermal resistance. These values are provided for reference only. Actual application performance is directly related to the surface roughness, flatness and pressure applied.

Typical Applications Include:

- Power supplies
- Motor controls
- Power semiconductors

Configurations Available:

- Sheet form, die-cut parts and roll form
- With or without pressure sensitive adhesive

Building a Part Number

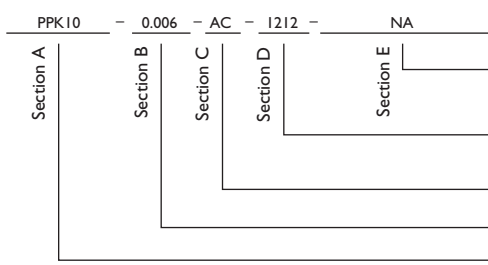

Standard Options

NA = Selected standard option. If not selecting a standard option, insert company name, drawing number, and revision level.

— = Standard configuration dash number, 1212 = 12" x 12" sheets, 12/250 = 12" x 250" rolls, or 00 = custom configuration

AC = Adhesive, one side
00 = No adhesive

Standard thicknesses available: 0.006"

PPK10 = Poly-Pad K-10 Material

Note: To build a part number, visit our website at www.bergquistcompany.com.

Sil-Pad®: U.S. Patents 4,574,879; 4,602,125; 4,602,678; 4,685,987; 4,842,911 and others

Kapton® is a registered trademark of DuPont.

SIL-PAD

Sil-Pad® Tubes

Silicone-Based, Thermally Conductive Tubes

Features and Benefits

- Thermal conductivity:
SPT 400 – 0.9 W/m-K
SPT 1000 – 1.2 W/m-K
- For clip-mounted plastic power packages



SPT 400 and SPT 1000 (Sil-Pad Tubes) provide thermally conductive insulation for clip-mounted plastic power packages. Sil-Pad Tubes are made of silicone rubber with high thermal conductivity.

Sil-Pad Tube 1000 is best suited for higher thermal performance. Sil-Pad Tube 400 is ideal for applications requiring average thermal conductivity and economy.

Sil-Pad Tube 400 and Sil-Pad Tube 1000 are designed to meet VDE, U.L. and TUV agency requirements.

Typical Applications Include:

- Clip-mounted power semiconductors
- TO-220, TO-218, TO-247 and TO-3P

Configurations Available:

- TO-220, TO-218, TO-247 and TO-3P

Special thickness and diameters can also be ordered. Please contact Bergquist Sales.

TYPICAL PROPERTIES OF SIL-PAD TUBE 400			
PROPERTY	IMPERIAL VALUE	METRIC VALUE	TEST METHOD
Color	Gray/Green	Gray/Green	Visual
Thickness / Wall (inch) / (mm)	0.012	0.30	ASTM D374
Hardness (Shore A)	80	80	ASTM D2240
Breaking Strength (lbs/inch) / (kN/m)	6	1	ASTM D1458
Continuous Use Temp (°F) / (°C)	-76 to 356	-60 to 180	—
ELECTRICAL			
Dielectric Breakdown Voltage (Vac)	5000	5000	ASTM D149
Dielectric Constant (1000 Hz)	5.5	5.5	ASTM D150
Volume Resistivity (Ohm-meter)	10 ¹¹	10 ¹¹	ASTM D257
Flame Rating	V-O	V-O	UL94
THERMAL			
Thermal Conductivity (W/m-K)	0.9	0.9	ASTM D5470
Thermal Impedance (°C-in ² /W) (I)	0.6	0.6	ASTM D5470
TYPICAL PROPERTIES OF SIL-PAD TUBE 1000			
PROPERTY	IMPERIAL VALUE	METRIC VALUE	TEST METHOD
Color	Brown	Brown	Visual
Thickness / Wall (inch) / (mm)	0.012	0.30	ASTM D374
Hardness (Shore A)	80	80	ASTM D2240
Breaking Strength (lbs/inch) / (kN/m)	6	1	ASTM D1458
Continuous Use Temp (°F) / (°C)	-76 to 356	-60 to 180	—
ELECTRICAL			
Dielectric Breakdown Voltage (Vac)	5000	5000	ASTM D149
Dielectric Constant (1000 Hz)	4.5	4.5	ASTM D150
Volume Resistivity (Ohm-meter)	10 ¹¹	10 ¹¹	ASTM D257
Flame Rating	V-O	V-O	UL94
THERMAL			
Thermal Conductivity (W/m-K)	1.2	1.2	ASTM D5470
Thermal Impedance (°C-in ² /W) (I)	0.4	0.4	ASTM D5470
1) The ASTM D5470 test fixture was used. The recorded value includes interfacial thermal resistance. These values are provided for reference only. Actual application performance is directly related to the surface roughness, flatness and pressure applied.			

Standard Dimensions

- A = Wall Thickness: .30 mm (.012") + .10 mm / -0.0 mm (+.004" / -0.0")
- B = Inner Diameter: 11 mm (.433") or 13.5 mm (.532") ± 1.0 mm (± .039")
- C = Length: 25 mm (.985") or 30 mm (1.18") +3.18 mm / -0.0 mm (+.125" / -0.0")

Special lengths are available. For more information, contact a Bergquist Sales Representative.

Ordering Procedure:

Sample: SPT 400 ___ - ___ - ___
"A" - "B" - "C"

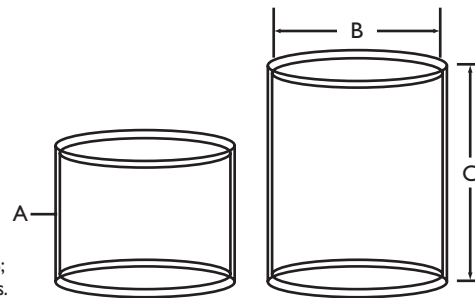

Sil-Pad®: U.S. Patents 4,574,879; 4,602,125; 4,602,678; 4,685,987; 4,842,911 and others.

SIL-PAD

Sil-Pad® Shield

Bonded Laminate of Sil-Pad with a Copper Shield

Features and Benefits

- Bonded laminate
- Electrically isolating
- Copper shield between layers of Sil-Pad
- Pre-tinned 60/40 solder point for easy grounding

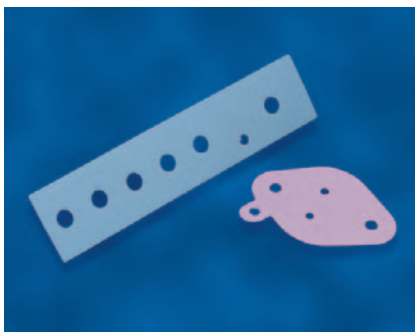

PROBLEM:

Radio Frequency Interference (RFI) is produced by heat sink current. The capacitance between a TO-3 encapsulated transistor and its heat sink is typically 100pf when a mica or other insulating washer is used. A power supply constructed with a standard insulator and a grounded heat sink can be expected to produce about 10 times more interference than is permitted.

SOLUTION:

1. The use of chokes, filters and LC networks which have to be designed into the circuitry.

OR

2. Constructing a shield between the transistor and its heat sink by replacing the mica insulator with a Sil-Pad Shield (see illustration).

TYPICAL PROPERTIES OF SIL-PAD SHIELD		
PROPERTY	VALUE	TEST METHOD
Thickness / Total (inches)	0.019	***
Shield / Copper Thickness (inches)	0.0015	***
Approx. Thermal Resistance (TO-3) (°C/W)	0.85 - 1.0	***
Min. Breakdown Voltage Between Device and Copper (Volts)	4500	ASTM D149
Capacitance @ 1000 Hz and 5 Volts (pF)	50	***
Dissipation Factor @ 1000 Hz and 5 Volts (Power Factor)	0.0155	ASTM D150
Dielectric Constant @ 1000 Hz and 5 Volts	5.5	ASTM D150
Continuous Use Temp. (°C)	-60 to 180	***
Recommended Torque (TO-3) (inch-pounds)	6-8	***

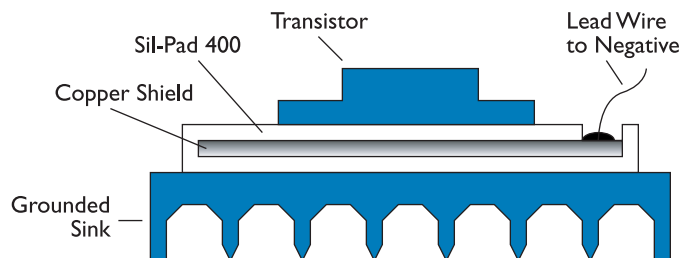

Typical Applications Include:

- Switch mode power supplies
- EMI / RFI shield between PCB's

Configurations Available:

Sil-Pad Shield is available in many custom configurations to meet special requirements. Tooling charges vary depending on tolerances and complexity of the part.

Sil-Pad Shield is a laminate of copper with Sil-Pad thermally conductive insulators. Sil-Pad Shield provides:

- Shielding effectiveness of 50dB or higher
- Good thermal transfer
- Reduced labor costs due to the elimination of having to apply thermal grease

Sil-Pad®: U.S. Patents 4,574,879; 4,602,125; 4,602,678; 4,685,987; 4,842,911 and others

SIL-PAD

Bond-Ply® and Liqui-Bond® Adhesives

Bond-Ply Adhesive Tapes

Available in a pressure sensitive adhesive or laminating format, the Bond-Ply family of materials are thermally conductive and electrically isolating. Bond-Ply facilitates the decoupling of bonded materials with mismatched thermal coefficients of expansion.

Typical Bond-Ply Applications

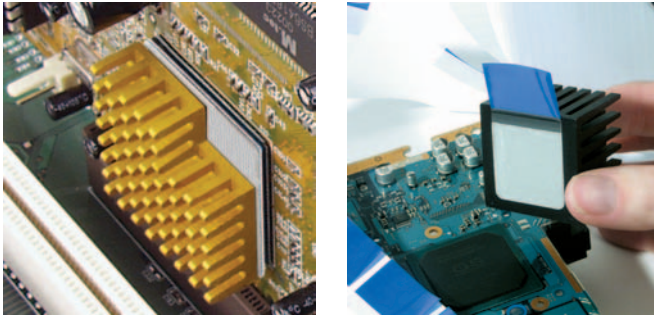

Features

- High performance, thermally conductive, pressure sensitive adhesive
- Material immediately bonds to the target surface
- Bond strength increases over time when repeatedly exposed to high continuous-use temperatures

Benefits

- Provide an excellent dielectric barrier
- Excellent wet-out to most types of component surfaces including plastic
- Bond-Ply 400 is unreinforced to increase conformance and wet-out on low surface energy materials
- Eliminates need for screws, clip mounts or fasteners

Options

- Supplied in sheet, die-cut, roll and tabulated forms
- Available in thickness range of 3 to 11 mil
- Custom coated thickness

Applications

- Attach a heat sink to a graphics processing unit
- Attach a heat spreader to a motor control PCB
- Attach a heat sink to a power converter PCB
- Attach a heat sink to a drive processor

Liqui-Bond Liquid Adhesives

Bergquist Liqui-Bond liquid adhesives are high performance, thermally conductive, liquid gap filling materials. These soft, form-in-place elastomers are ideal for coupling "hot" electronic components mounted on PC boards with an adjacent metal case or heat sink.

Typical Liqui-Bond Applications

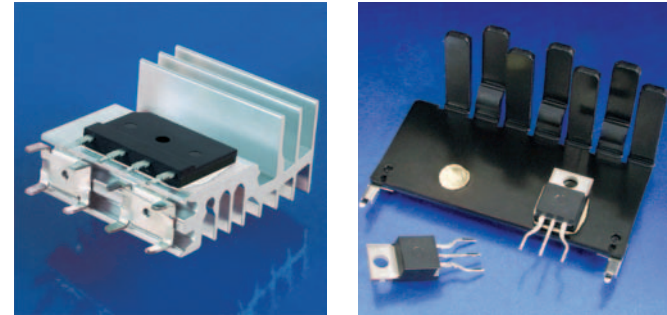

Features

- Excellent low and high temperature mechanical and chemical stability

Benefits

Before cure, Liqui-Bond flows under pressure like a grease. After cure, it bonds the components, eliminating the need for mechanical fasteners. Additional benefits include:

- Low modulus provides stress-absorbing flexibility
- Supplied as a one-part material with an elevated temperature curing system
- Offers infinite thickness with little or no stress during displacement
- Eliminates need for specific pad thickness and die-cut shapes for individual applications

Options

The growing Liqui-Bond family offers a variety of choices to meet the customer's performance, handling and process needs.

Applications

Liqui-Bond products are intended for use in thermal interface applications where a structural bond is a requirement. This material is formulated for high cohesive and adhesive strength and cures to a low modulus. Typical applications include:

- Automotive electronics
- Telecommunications
- Computer and peripherals
- Between any heat-generating semiconductor and a heat sink

Frequently Asked Questions

Q: What is the primary difference between the Bond-Ply 660B and Bond-Ply 100 products?

A: Bond-Ply 660B utilizes a dielectric film, replacing the fiberglass inherent in our Bond-Ply 100 series products. The addition of the film allows for high dielectric performance without additional product thickness.

Q: How should I size my interface dimensions for Bond-Ply?

A: Bond-Ply product testing has been completed on various interface materials. These tests have demonstrated that improper surface wet-out is the single largest variable associated with maximizing bond strength and heat transfer. Bergquist has found that reducing the size of the interface pad to roughly 80% of the total interface area actually improves the overall bonding performance while offering significant improvements in total package cooling. Bergquist offers three standard thicknesses for Bond-Ply 100 allowing each application to be optimized in three dimensions.

Q: What application pressure is required to optimize bond strength with Bond-Ply?

A: The answer to this varies from application to application, depending upon surface roughness and flatness. In general, pressure, temperature, and time are the primary variables associated with increasing surface contact or wet-out. Increasing the application time and/or pressure will significantly increase surface contact. Natural wet-out will continue to occur with Bond-Ply materials. This inherent action often increases bond strength by more than 2x within the first 24 hours.

Q: Will Bond-Ply adhere to plastic packages?

A: Adhesive performance on plastic packages is primarily a function of surface contact or wet-out. If surface contaminants such as plastic mold release oils are present, this will prevent contact and/or bonding to the surface. Make sure all surfaces are clean and dry prior to applying Bond-Ply materials.

Q: How are one-part Liqui-Bond adhesives cured?

A: Liqui-Bond SA 2000 and Liqui-Bond SA 1000 require heat to cure and bond in the application. Altering the bond line temperature and time can control the cure schedule. The components should not be moved during the curing process.

Bond-Ply® Comparison Data

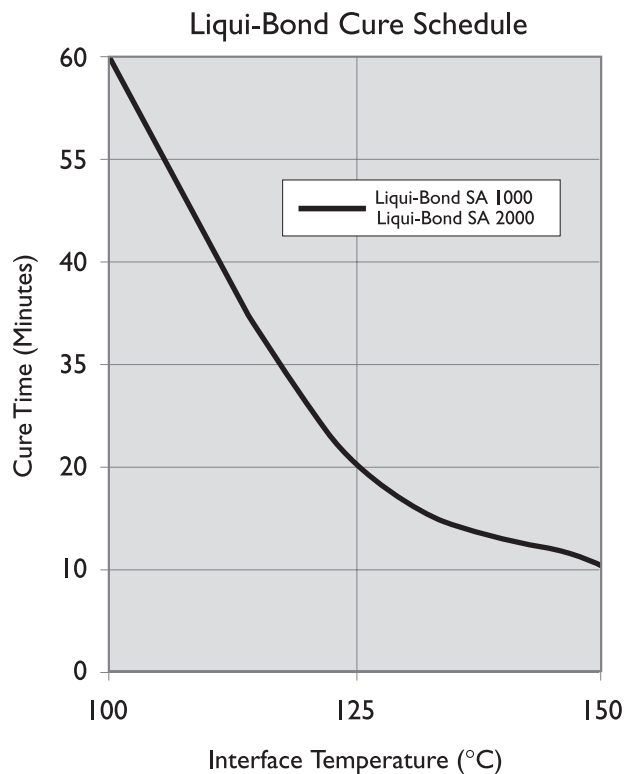
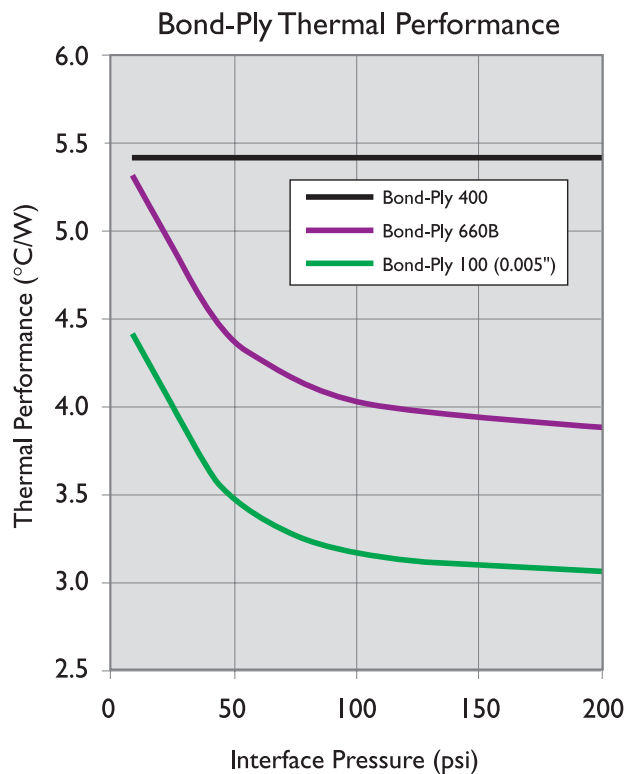

BOND-PLY

Bond-Ply® 100

Thermally Conductive, Fiberglass Reinforced Pressure Sensitive Adhesive Tape

Features and Benefits

- Thermal impedance: 0.86°C-in²/W (@100 psi)
- High bond strength to a variety of surfaces
- Double-sided, pressure sensitive adhesive tape
- High performance, thermally conductive acrylic adhesive
- Can be used instead of heat-cure adhesive, screw mounting or clip mounting

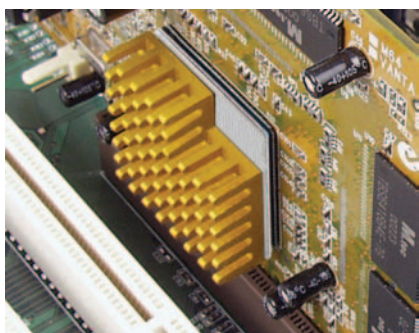

Typical Applications Include:

- Mount heat sink onto BGA graphic processor or drive processor
- Mount heat spreader onto power converter PCB or onto motor control PCB

Configurations Available:

- Sheet form, roll form and die-cut parts

Shelf Life: The double-sided, pressure sensitive adhesive used in Bond-Ply products requires the use of dual liners to protect the surfaces from contaminants. Bergquist recommends a 6-month shelf life at a maximum continuous storage temperature of 35°C or 3-month shelf life at a maximum continuous storage temperature of 45°C, for maintenance of controlled adhesion to the liner. The shelf life of the Bond-Ply material, without consideration of liner adhesion (which is often not critical for manual assembly processing), is recommended at 12 months from date of manufacture at a maximum continuous storage temperature of 60°C.

TYPICAL PROPERTIES OF BOND-PLY 100						
PROPERTY	IMPERIAL VALUE	METRIC VALUE	TEST METHOD			
Color	White	White	Visual			
Reinforcement Carrier	Fiberglass	Fiberglass	—			
Thickness (inch) / (mm)	0.005, 0.008, 0.011	0.127, 0.203, 0.279	ASTM D374			
Temp. Resistance, 30 sec. (°F) / (°C)	392	200	—			
Elongation (%45° to Warp & Fill)	70	70	ASTM D412			
Tensile Strength (psi) / (MPa)	900	6	ASTM D412			
CTE (ppm)	325	325	ASTM D3386			
Glass Transition (°F) / (°C)	-22	-30	ASTM I356			
Continuous Use Temp (°F) / (°C)	-22 to 248	-30 to 120	—			
ADHESION						
Lap Shear @ RT (psi) / (MPa)	100	0.7	ASTM D1002			
Lap Shear after 5 hr @ 100°C	200	1.4	ASTM D1002			
Lap Shear after 2 min @ 200°C	200	1.4	ASTM D1002			
Static Dead Weight Shear (°F) / (°C)	302	150	PSTC#7			
ELECTRICAL		VALUE	TEST METHOD			
Dielectric Breakdown Voltage - 0.005" (Vac)		3000	ASTM D149			
Dielectric Breakdown Voltage - 0.008" (Vac)		6000	ASTM D149			
Dielectric Breakdown Voltage - 0.011" (Vac)		8500	ASTM D149			
Flame Rating		V-O	UL94			
THERMAL						
Thermal Conductivity (W/m-K)		0.8	ASTM D5470			
THERMAL PERFORMANCE vs PRESSURE						
	Pressure (psi)	10	25	50	100	200
TO-220 Thermal Performance (°C/W) 0.005"		4.39	4.02	3.48	3.15	3.05
TO-220 Thermal Performance (°C/W) 0.008"		5.11	4.69	4.53	4.45	4.38
TO-220 Thermal Performance (°C/W) 0.011"		6.26	5.92	5.73	5.63	5.53
Thermal Impedance (°C-in ² /W) 0.005" (1)		0.78	0.61	0.58	0.55	0.54
Thermal Impedance (°C-in ² /W) 0.008" (1)		1.28	0.94	0.90	0.86	0.84
Thermal Impedance (°C-in ² /W) 0.011" (1)		2.47	1.22	1.19	1.14	1.11
1) The ASTM D5470 test fixture was used. The recorded value includes interfacial thermal resistance. These values are provided for reference only. Actual application performance is directly related to the surface roughness, flatness and pressure applied.						

Building a Part Number

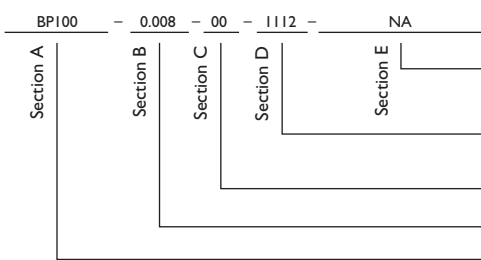

Standard Options

- **NA** = Selected standard option. If not selecting a standard option, insert company name, drawing number, and revision level.
- 1112 = 11" x 12" sheets, 11250 = 11" x 250' rolls or 00 = custom configuration
- 00 = No adhesive
- Standard thicknesses available: 0.005", 0.008", 0.011"
- BP100 = Bond-Ply 100 Material

Note: To build a part number, visit our website at www.bergquistcompany.com.

Bond-Ply®: U.S. Patent 5,090,484 and others.

BOND-PLY

Bond-Ply[®] 400

Thermally Conductive, Unreinforced, Pressure Sensitive Adhesive Tape

Features and Benefits

- Thermal impedance: 0.87°C-in²/W (@50 psi)
- Easy application
- Eliminates need for external hardware (screws, clips, etc.)
- Available with easy release tabs

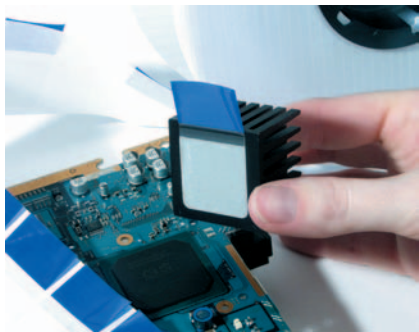

Bergquist Bond-Ply 400 is an un-reinforced, thermally conductive, pressure sensitive adhesive tape. The tape is supplied with protective topside tabs and a carrier liner. Bond-Ply 400 is designed to attain high bond strength to a variety of "low energy" surfaces, including many plastics, while maintaining high bond strength with long term exposure to heat and high humidity.

Typical Applications Include:

- Secure:
- Heat sink onto BGA graphic processor
 - Heat sink to computer processor
 - Heat sink onto drive processor
 - Heat spreader onto power converter PCB
 - Heat spreader onto motor control PCB

Configurations Available:

- Die-cut parts (supplied on rolls with easy release, protective tabs)

TYPICAL PROPERTIES OF BOND-PLY 400					
PROPERTY	IMPERIAL VALUE	METRIC VALUE	TEST METHOD		
Color	White	White	Visual		
Thickness (inch) / (mm)	0.005	0.127	ASTM D374		
Glass Transition (°F) / (°C)	-22	-30	ASTM E1356		
Continuous Use Temp (°F) / (°C)	-22 to 248	-30 to 120	—		
ADHESION					
Lap Shear @ RT (psi) / (MPa)	100	0.7	ASTM D1002		
Lap Shear after 5 hr @ 100°C	200	1.4	ASTM D1002		
Lap Shear after 2 min @ 200°C	200	1.4	ASTM D1002		
ELECTRICAL		VALUE	TEST METHOD		
Dielectric Breakdown Voltage (Vac)		3000	ASTM D149		
Flame Rating		V-O	UL94		
THERMAL					
Thermal Conductivity (W/m-K)		0.4	ASTM D5470		
THERMAL PERFORMANCE vs PRESSURE					
Initial Assembly Pressure (psi for 5 seconds)	10	25	50	100	200
TO-220 Thermal Performance (°C/W) 0.005"	5.4	5.4	5.4	5.4	5.4
Thermal Impedance (°C-in ² /W) (1)			0.87		

1) The ASTM D5470 test fixture was used. The recorded value includes interfacial thermal resistance. These values are provided for reference only. Actual application performance is directly related to the surface roughness, flatness and pressure applied.

Shelf Life: The double-sided pressure sensitive adhesive used in Bond-Ply products requires the use of dual liners to protect the surfaces from contaminants. Bergquist recommends a 6-month shelf life at a maximum continuous storage temperature of 35°C, or 3-month shelf life at a maximum continuous storage temperature of 45°C, for maintenance of controlled adhesion to the liner. The shelf life of the Bond-Ply material, without consideration of liner adhesion (which is often not critical for manual assembly processing), is recommended at 12 months from date of manufacture at a maximum continuous storage temperature of 60°C.

Building a Part Number

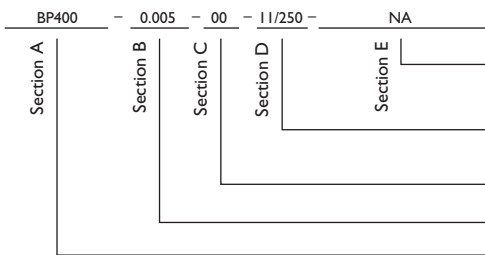

Standard Options

- ◀ example
- NA = Selected standard option. If not selecting a standard option, insert company name, drawing number, and revision level.
 - 11/250 = 11" x 250' rolls or 00 = custom configuration
 - 00 = No adhesive
 - Standard thicknesses available: 0.005"
 - BP400 = Bond-Ply 400 Material

Note: To build a part number, visit our website at www.bergquistcompany.com.

Bond-Ply[®]: U.S. Patent 5,090,484 and others.

BOND-PLY

Bond-Ply® 660B

Thermally Conductive, Film Reinforced, Pressure Sensitive Adhesive Tape

Features and Benefits

- Designed to replace mechanical fasteners or screws
- For applications that require electrical isolation
- Double-sided pressure sensitive adhesive tape

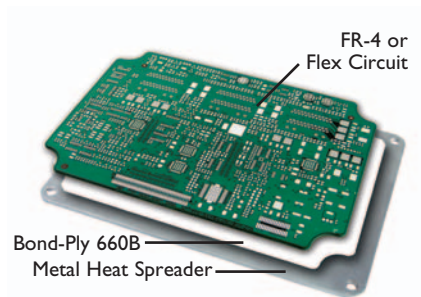

Bond-Ply 660B is a thermally conductive, electrically insulating, double-sided pressure sensitive adhesive tape. The tape consists of a high performance, thermally conductive acrylic adhesive coated on both sides of a PEN film. Use Bond-Ply 660B in applications to replace mechanical fasteners or screws.

Typical Applications Include:

- Mount heat sink onto BGA graphic processor
- Mount heat sink onto drive processor
- Mount heat spreader onto power converter PCB
- Mount heat spreader onto motor control PCB

Configurations Available:

• Roll form and die-cut parts
 The material as delivered will include a continuous base liner with differential release properties to allow simplicity in roll packaging and application assembly.

TYPICAL PROPERTIES OF BOND-PLY 660B						
PROPERTY	IMPERIAL VALUE	METRIC VALUE	TEST METHOD			
Color	White	White	Visual			
Reinforcement Carrier	PEN Film	PEN Film	—			
Thickness (inch) / (mm)	0.0055	0.14	ASTM D374			
Temp. Resistance, 30 sec. (°F) / (°C)	392	200	—			
Elongation (%)	40	40	ASTM D412			
Tensile Strength (psi) / (MPa)	30000	210	ASTM D412			
CTE (ppm)	250	250	ASTM D3386			
Glass Transition (°F) / (°C)	-22	-30	ASTM E1356			
Continuous Use Temp (°F) / (°C)	-22 to 248	-30 to 120	—			
ADHESION						
Lap Shear @ RT (psi) / (MPa)	100	0.7	ASTM D1002			
Lap Shear after 5 hr @ 100°C	200	1.4	ASTM D1002			
Lap Shear after 2 min @ 200°C	200	1.4	ASTM D1002			
Static Dead Weight Shear (°F) / (°C)	302	150	PSTC#7			
ELECTRICAL						
Dielectric Breakdown Voltage (Vac)	7000	7000	ASTM D149			
Flame Rating	V-O	V-O	UL94			
THERMAL						
Thermal Conductivity (W/m-K)	0.4	0.4	ASTM D5470			
THERMAL PERFORMANCE vs PRESSURE						
	Pressure (psi)	10	25	50	100	200
TO-220 Thermal Performance (°C/W)		5.30	4.94	4.38	4.02	3.88
Thermal Impedance (°C-in ² /W) (1)		1.15	0.79	0.74	0.72	0.70

1) The ASTM D5470 (Bergquist modified) test fixture was used. The recorded value includes interfacial thermal resistance. These values are provided for reference only. Actual application performance is directly related to the surface roughness, flatness and pressure applied.

Shelf Life: The double-sided pressure sensitive adhesive used in Bond-Ply products requires the use of dual liners to protect the surfaces from contaminants. Bergquist recommends a 6-month shelf life at a maximum continuous storage temperature of 35°C, or 3-month shelf life at a maximum continuous storage temperature of 45°C, for maintenance of controlled adhesion to the liner. The shelf life of the Bond-Ply material, without consideration of liner adhesion (which is often not critical for manual assembly processing), is recommended at 12 months from date of manufacture at a maximum continuous storage temperature of 60°C.

Building a Part Number

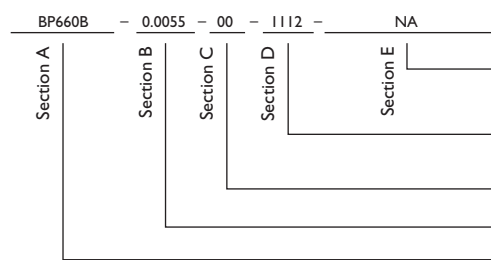

Standard Options Bond-Ply®:

◀ *example*
 NA = Selected standard option. If not selecting a standard option, insert company name, drawing number, and revision level.
 1112 = 11" x 12" sheets, 11/250 = 11" x 250' rolls, or 00 = custom configuration
 00 = No adhesive
 Standard thicknesses available: 0.0055"
 BP660B = Bond-Ply 660B Material

Note: To build a part number, visit our website at www.bergquistcompany.com.

U.S. Patent 5,090,484 and others.

BOND-PLY

Liqui-Bond™ SA 1000 (One-Part)

Thermally Conductive, One-Part, Liquid Silicone Adhesive

Features and Benefits

- High thermal performance
- Eliminates need for mechanical fasteners
- Low viscosity for ease of screening or stenciling
- Can achieve a very thin bond line
- Mechanical and chemical stability
- Maintains structural bond in severe-environment applications
- Heat cure

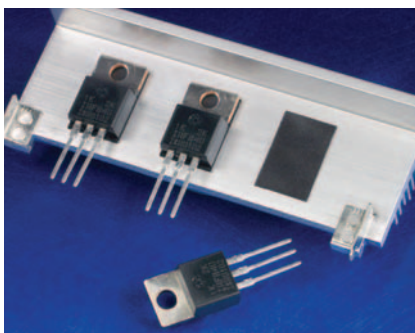

Liqui-Bond SA 1000 is a thermally conductive, one-part liquid silicone adhesive with a low viscosity for easy screenability. Liqui-Bond SA 1000 features a high thermal performance and maintains its structure even in severe-environment applications.

Liqui-Bond SA 1000 features excellent low and high-temperature mechanical and chemical stability. The material's mild elastic properties assist in relieving CTE stresses during thermal cycling. Liqui-Bond SA 1000 contains no cure by-products, cures at elevated temperatures and requires refrigeration storage at 10°C. The material is available in both tube and mid-sized container forms.

TYPICAL PROPERTIES OF LIQUI-BOND SA 1000			
PROPERTY AS SUPPLIED	IMPERIAL VALUE	METRIC VALUE	TEST METHOD
Color	Black	Black	Visual
Viscosity (cps) (1)	125,000	125,000	ASTM B2196
Density (g/cc)	2.4	2.4	ASTM D792
Shelf Life @ 10°C (months)	6	6	—
PROPERTY AS CURED - PHYSICAL			
Hardness (Shore A)	75	75	ASTM D2240
Continuous Use Temp (°F) / (°C)	-76 to 392	-60 to 200	—
Shear Strength (psi) / (MPa)	200	1.4	ASTM D1002
PROPERTY AS CURED - ELECTRICAL			
Dielectric Strength (V/mil) / (V/mm)	250	10,000	ASTM D149
Dielectric Constant (1000 Hz)	5.5	5.5	ASTM D150
Volume Resistivity (Ohm-meter)	10 ¹⁰	10 ¹⁰	ASTM D257
Flame Rating	V-O	V-O	U.L.94
PROPERTY AS CURED - THERMAL			
Thermal Conductivity (W/m-K)	1.0	1.0	ASTM D5470
CURE SCHEDULE			
Pot Life @ 25°C (hours) (2)	10	10	—
Cure @ 125°C (minutes) (3)	20	20	—
Cure @ 150°C (minutes) (3)	10	10	—

1) Brookfield RV, Heli-path, Spindle TF @ 20 rpm, 25°C.
 2) Based on 1/8" diameter bead.
 3) Cure Schedule - time after cure temperature is achieved at the interface. Ramp time is application dependent.

Typical Applications Include:

- PCBA to housing
- Discrete component to heat spreader

Configurations Available:

- With or without glass beads

Building a Part Number

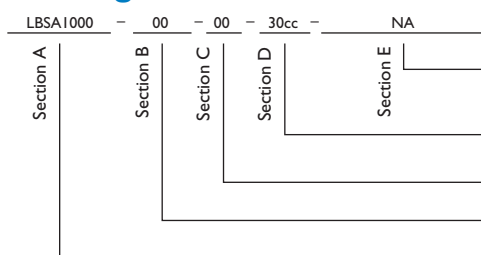

Standard Options

◀ example
 NA = Selected standard option. If not selecting a standard option, insert company name, drawing number, and revision level.
 Cartridges: 30cc = 30.0cc, 600cc = 600.0cc (ml)
 Pail: 1G = 1-gallon, 5G = 5-gallon
 00 = No adhesive
 00 = No spacer beads
 07 = 0.007" spacer beads
 LBSA1000 = Liqui-Bond SA 1000 Liquid Adhesive Material

Note: To build a part number, visit our website at www.bergquistcompany.com.

BOND-PLY

Liqui-Bond™ SA 2000

Thermally Conductive, One-Part, Liquid Silicone Adhesive

Features and Benefits

- High thermal conductivity: 2.0 W/m-K
- Eliminates need for mechanical fasteners
- One-part formulation for easy dispensing
- Mechanical and chemical stability
- Maintains structural bond in severe-environment applications
- Heat cure

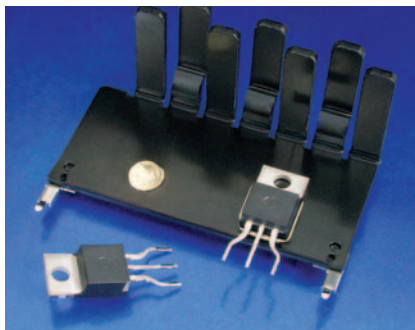

Liqui-Bond SA 2000 is a high performance, thermally conductive silicone adhesive that cures to a solid bonding elastomer. Liqui-Bond SA 2000 is supplied as a one-part liquid component, in either tube or mid-sized container form.

Liqui-Bond SA 2000 features excellent low and high-temperature mechanical and chemical stability. The material's mild elastic properties assist in relieving CTE stresses during thermal cycling. Liqui-Bond SA 2000 cures at elevated temperatures and requires refrigeration storage at 10°C.

TYPICAL PROPERTIES OF LIQUI-BOND SA 2000			
PROPERTY AS SUPPLIED	IMPERIAL VALUE	METRIC VALUE	TEST METHOD
Color	Yellow	Yellow	Visual
Viscosity (cps) (1)	200,000	200,000	ASTM B2196
Density (g/cc)	2.4	2.4	ASTM D792
Shelf Life @ 10°C (months)	6	6	—
PROPERTY AS CURED - PHYSICAL			
Hardness (Shore A)	80	80	ASTM D2240
Continuous Use Temp (°F) / (°C)	-76 to 392	-60 to 200	—
Shear Strength (psi) / (MPa)	200	1.4	ASTM D1002
PROPERTY AS CURED - ELECTRICAL			
Dielectric Strength (V/mil) / (V/mm)	250	10,000	ASTM D149
Dielectric Constant (1000 Hz)	6.0	6.0	ASTM D150
Volume Resistivity (Ohm-meter)	10 ¹¹	10 ¹¹	ASTM D257
Flame Rating	V-O	V-O	UL94
PROPERTY AS CURED - THERMAL			
Thermal Conductivity (W/m-K)	2.0	2.0	ASTM D5470
CURE SCHEDULE			
Pot Life @ 25°C (hours) (2)	24	24	—
Cure @ 125°C (minutes) (3)	20	20	—
Cure @ 150°C (minutes) (3)	10	10	—

1) Brookfield RV, Heli-path, Spindle TF @ 20 rpm, 25°C.
 2) Based on 1/8" diameter bead.
 3) Cure Schedule - time after cure temperature is achieved at the interface. Ramp time is application dependent.

Typical Applications Include:

- PCBA to housing
- Discrete component to heat spreader

Configurations Available:

- With or without glass beads

Building a Part Number

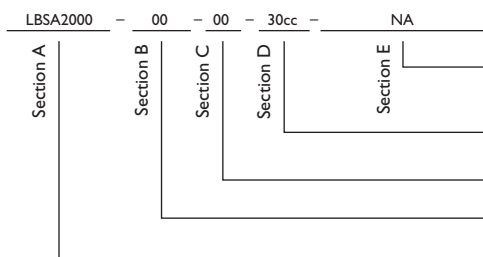

Standard Options

◀ example
 NA = Selected standard option. If not selecting a standard option, insert company name, drawing number, and revision level.
 Cartridges: 30cc = 30.0cc, 600cc = 600.0cc (ml)
 Pail: 1G = 1-gallon, 5G = 5-gallon
 00 = No adhesive
 00 = No spacer beads
 07 = 0.007" spacer beads
 LBSA2000 = Liqui-Bond SA 2000 Liquid Adhesive Material

Note: To build a part number, visit our website at www.bergquistcompany.com.

BOND-PLY

Assistance is Just a Click Away

“TechChat” Online Technical Support

Real-Time Response to Important Issues Facing Design Engineers, Engineering Managers and Product Specifiers.

Need help selecting the right Bergquist thermal management product for your specific application needs?

The Bergquist Company website features a service for designers, engineers and specifiers — “TechChat,” an online technical support service for anyone who desires immediate support via the web. “TechChat” can be found at: www.bergquistcompany.com

“TechChat” provides real-time answers to technical issues faced when designing and specifying thermal management materials, touch screens, membrane switches or electronic components. TechChat is available Monday - Friday, 8am-5pm, CST.



From the simplest of questions to the most complex, Bergquist’s seasoned professionals draw on the company’s extensive experience with thermal management as well as membrane switch, touch screen and electronic component applications.

ORDERING

Solutions for Surface Mount Applications

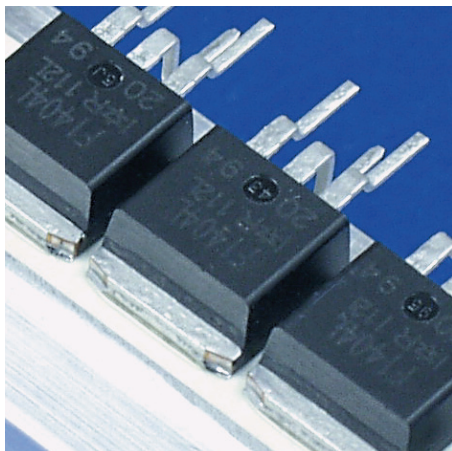

Hi-Flow

The Hi-Flow family of phase change materials offers an easy-to-apply thermal interface for many surface mount packages. At the phase change temperature, Hi-Flow materials change from a solid and flow with minimal applied pressure. This characteristic optimizes heat transfer by maximizing wet-out of the interface. Hi-Flow is commonly used to replace messy thermal grease.

Bergquist phase change materials are specially compounded to prevent pump-out of the interface area, which is often associated with thermal grease. Typical applications for Hi-Flow materials include:

- Pentium®, Athlon®, Core 2 Duo and other high performance CPUs
- DC/DC converters
- Power modules

Hi-Flow materials are manufactured with or without film or foil carriers. Custom shapes and sizes for non-standard applications are also available.

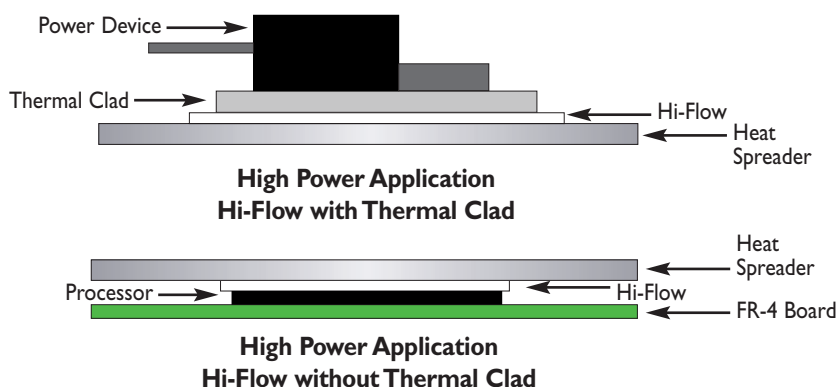
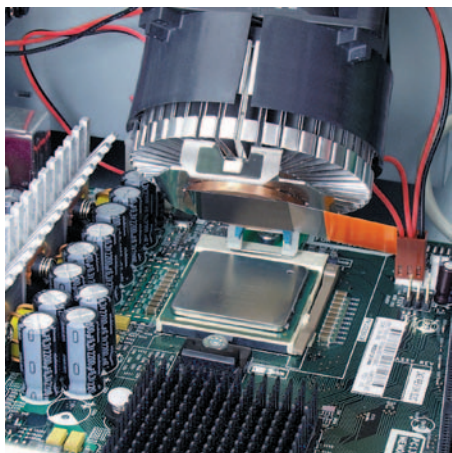

Sil-Pad

Sil-Pad is the benchmark in thermal interface materials. The Sil-Pad family of materials are thermally conductive and electrically insulating. Available in custom shapes, sheets, and rolls, Sil-Pad materials come in a variety of thicknesses and are frequently used in SMT applications such as:

- Interface between thermal vias in a PCB, and a heat sink or casting
- Heat sink interface to many surface mount packages

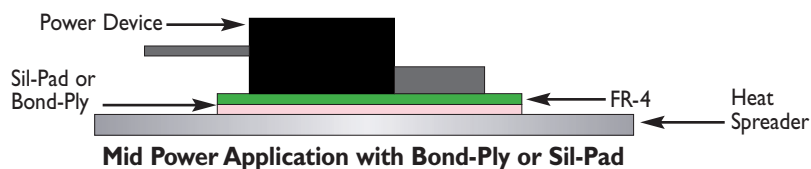
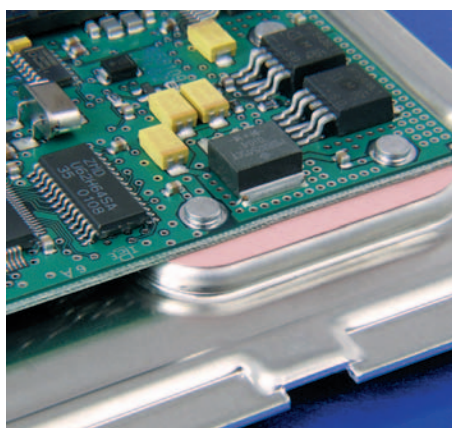

Pentium® is a registered trademark of Intel Corporation.
Athlon® is a registered trademark of Advanced Micro Devices, Inc.

Where Thermal Solutions Come Together

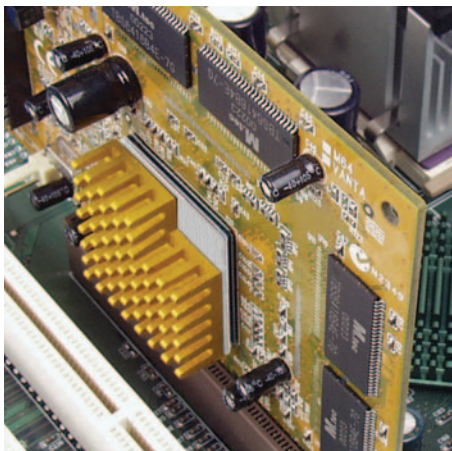

Bond-Ply and Liqui-Bond

The Bond-Ply family of materials are thermally conductive and electrically isolating. Bond-Ply is available in a pressure sensitive adhesive or laminating format. Liqui-Bond is a high thermal performance liquid silicone adhesive that cures to a solid bonding elastomer. Bond-Ply provides for the mechanical decoupling of bonded materials with mismatched thermal coefficients of expansion. Typical applications include:

- Bonding bus bars in a variety of electronic modules and sub assemblies
- Attaching a metal-based component to a heat sink
- Bonding a heat sink to a variety of ASIC, graphic chip, and CPU packages
- Bonding flexible circuits to a rigid heat spreader or thermal plane
- Assembly tapes for BGA heat spreader
- Attaching PCB assemblies to housings

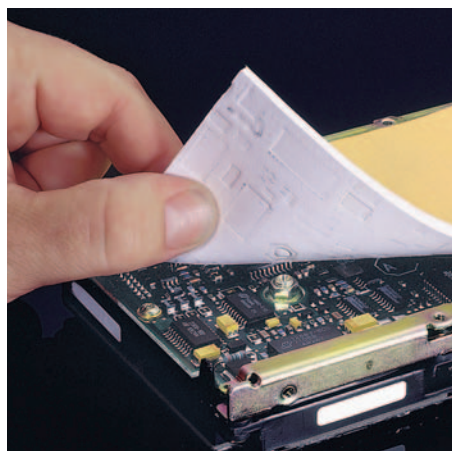

Gap Pad and Gap Filler

The Gap Pad product family offers a line of thermally conductive materials which are highly conformable. Varying degrees of thermal conductivity and compression deflection characteristics are available. Typical applications include:

- On top of a semiconductor package such as a QFP or BGA. Often times, several packages with varying heights can use a common heat sink when utilizing Gap Pad
- Between a PCB or substrate and a chassis, frame, or other heat spreader
- Areas where heat needs to be transferred to any type of heat spreader
- For interfacing pressure sensitive devices
- Filling various gaps between heat-generating devices and heat sinks or housings

Gap Pads are available in thickness of 0.010" to 0.250", and in custom shapes, with or without adhesive. Gap Fillers are available in cartridge or kit form.

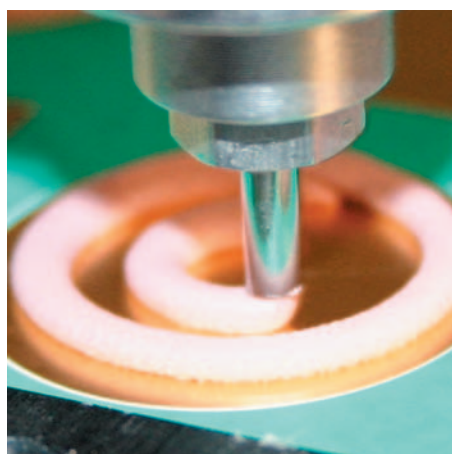
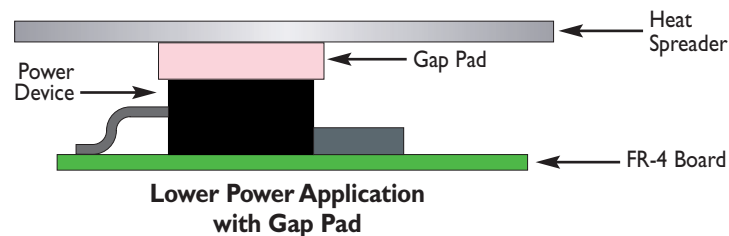

Top Efficiency In Thermal Materials For Today's Changing Technology.

Contact Bergquist for additional information regarding our Thermal Solutions. We are constantly innovating to offer you the greatest selection of options and flexibility to meet today's changing technology.



ORDERING

Ordering Information

Ordering Procedure:

The last 2 or 3 digits define the part number selected. The "foot print" and dimensions are shown on pages 87-95.

Special Shapes:

For applications requiring non-standard or custom Sil-Pad configurations, contact your Bergquist Sales Representative. We produce thousands of custom die shapes and designs.

Tolerances:

Typical converting tolerances are held on length (L), width (W), hole diameter and hole location for most materials as noted below:

TYPICAL SIL-PAD / HI-FLOW TOLERANCES		
Part Dimension	Length and Width Tolerance	Hole Location and Diameter
<6"	± 0.010"	± 0.005"
6" - 12"	± 0.015"	± 0.010"
>12"	± 0.020"	TBD
TYPICAL GAP PAD TOLERANCES		
Material Thickness	Length and Width Tolerance	Hole Location and Diameter
10 mil	± 0.015"	± 0.015"
15 mil	± 0.015"	± 0.015"
20 mil	± 0.020"	± 0.020"
40 mil	± 0.035"	± 0.035"
60 mil	± 0.050"	± 0.050"
80 mil	± 0.050"	± 0.050"
100 mil	± 0.060"	± 0.060"
125 mil	± 0.075"	± 0.075"
160 mil	± 0.100"	± 0.100"
200 mil	± 0.125"	± 0.125"
250 mil	± 0.160"	± 0.160"

Note: Dependent upon material and application requirements, tighter tolerances may be feasible and available. Please contact Bergquist Sales for these requests and additional information regarding tolerances.

Sheets:

Standard sheet size for most materials is 12" x 12", with or without adhesive as specified on the individual data sheet. When ordering sheets, please specify material type, thickness and include all dimensions. Contact Bergquist Sales if other sizes are required.

Note: Sil-Pad A2000 maximum sheet size is 10" x 12". Gap Pad standard sheet size is 8" x 16".

Rolls:

Sil-Pad materials are available in roll form, with or without adhesive, with the exception of Sil-Pad 1750 and Sil-Pad 2000. Hi-Flow materials are available in roll form. Certain Gap Pad materials are available in roll form. Please contact Bergquist Sales for more information.

Adhesives:

Bergquist adhesives include:

- SILICONE:** (AC) - Unloaded
(ACA) - Unloaded, Low Tack
(TAC) - Loaded (Thermally Enhanced)
- ACRYLIC:** (AAC) - Unloaded
(TAAC) - Thermally Loaded
(EAAC) - Thermally Enhanced

THICKNESS: 0.0005" - 0.001", (12-25µm) (adhesive only)

Note: For non-symmetrical parts, please indicate on print which side the adhesive is on.

Peel Strength: See data below.

POL = Peel-Off Liner (force per unit width of the liner to the adhesive).

QS = Quick Stick (simulated force per unit width of the adhesive to the heat sink).

g/in = Grams per inch.

TYPICAL ADHESIVE PROPERTIES		
ADHESIVE	POL	QS
Silicone AC	50-150 g/in	50-150 g/in
Silicone ACA	5-70 g/in	5-150 g/in
Silicone TAC	50-150 g/in	50-150 g/in
Acrylic AAC	5-70 g/in	100-800 g/in
Acrylic TAAC	5-70 g/in	100-400 g/in
Acrylic EAAC	5-60 g/in	100-200 g/in

Note: These values are typical after the material has aged for 2-3 weeks and are significantly different immediately after coating. Upon completion of coating, QS is 250-500 g/in and POL is 3-20 g/in for all silicone adhesives.

Shelf Life:

Silicone Adhesives: Six (6) months from date of manufacture when stored in original packaging at 70°F (21°C) and 50% relative humidity.

Acrylic Adhesives: One (1) year from date of manufacture when stored in original packaging at 70°F (21°C) and 50% relative humidity.

Peel adhesion data is available upon request. Please contact Bergquist Sales for more information.

ORDERING

Ordering Information

Ordering Procedure:

The last 2 or 3 digits define the part number selected. The "foot print" and dimensions are shown on pages 87-95.

Special Shapes:

For applications requiring non-standard or custom Sil-Pad configurations, contact your Bergquist Sales Representative. We produce thousands of custom die shapes and designs.

Tolerances:

Typical converting tolerances are held on length (L), width (W), hole diameter and hole location for most materials as noted below:

Sheets:

Standard sheet size for most materials is 12" x 12", with or without adhesive as specified on the individual data sheet. When ordering sheets, please specify material type, thickness and include all dimensions. Contact Bergquist Sales if other sizes are required.

Note: Sil-Pad A2000 maximum sheet size is 10" x 12". Gap Pad standard sheet size is 8" x 16".

Rolls:

Sil-Pad materials are available in roll form, with or without adhesive, with the exception of Sil-Pad 1750 and Sil-Pad 2000. Hi-Flow materials are available in roll form. Certain Gap Pad materials are available in roll form. Please contact Bergquist Sales for more information.

Adhesives:

Bergquist adhesives include:

- | | |
|------------------|-------------------------------------|
| SILICONE: | (AC) - Unloaded |
| | (ACA) - Unloaded, Low Tack |
| | (TAC) - Loaded (Thermally Enhanced) |
| ACRYLIC: | (AAC) - Unloaded |
| | (TAAC) - Thermally Loaded |
| | (EAAC) - Thermally Enhanced |

THICKNESS: 0.0005" - 0.001", (12-25 μ m) (adhesive only)

Note: For non-symmetrical parts, please indicate on print which side the adhesive is on.

Peel Strength: See data below.

POL = Peel-Off Liner (force per unit width of the liner to the adhesive).

QS = Quick Stick (simulated force per unit width of the adhesive to the heat sink).

g/in = Grams per inch.

Note: These values are typical after the material has aged for 2-3 weeks and are significantly different immediately after coating. Upon completion of coating, QS is 250-500 g/in and POL is 3-20 g/in for all silicone adhesives.

Shelf Life:

Silicone Adhesives: Six (6) months from date of manufacture when stored in original packaging at 70°F (21°C) and 50% relative humidity.

Acrylic Adhesives: One (1) year from date of manufacture when stored in original packaging at 70°F (21°C) and 50% relative humidity.

Peel adhesion data is available upon request. Please contact Bergquist Sales for more information.

PSA Characteristics:

Standard pressure sensitive adhesive (AC) coated on one side of a Sil-Pad will increase the thermal resistance (per ASTM D5470) by 0.2°C-in²/W. Standard pressure sensitive adhesive on 2 sides increases the thermal impedance by 0.4°C-in²/W.

Thermally conductive pressure sensitive adhesive (TAC) on one side increases the thermal resistance by 0.05°C-in²/W and on two sides by 0.1°C-in²/W.

The effect of AC and TAC on the thermal impedance in an application will vary. In low-pressure applications, the pressure sensitive adhesive will wet-out the interface easier and eliminate the interfacial thermal resistance.

Note: Bergquist adhesives are designed for ease of application during assembly. If an automated dispensing method is preferred, Bergquist will recommend manufacturers of automated dispensing equipment upon request. Please contact Bergquist Sales for more information on this subject.

Note: Bergquist cannot be responsible for dispensing equipment selection and/or performance of specific materials on said equipment. It is the customer's responsibility to determine the suitability and compatibility of the specific Bergquist material with the selected equipment.

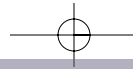

Sil-Pad® Configurations

Imperial Measurements

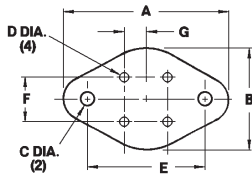

4 Lead TO-66	Part Number Suffix	"A"	"B"	"C"	"D"	"E"	"F"	"G"
	-84	1.312	.762	.140	.062	.960	.200	.100

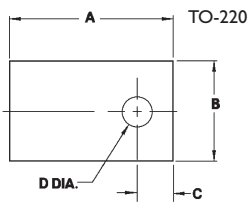

Plastic Power	Part Number Suffix	"A"	Dimensions "B"	"C"	"D"	Part Number Suffix	"A"	Dimensions "B"	"C"	"D"	
Various	-35	.710	.500	.160	.141	Various	-104	1.000	.750	.300	.140
(Clip Mount)	-43	.750	.500			Various	-107	.810	.910	.170	.147
TO-126	-50	.437	.312	.140	.093	Various	-110	.984	.787		
Various	-51	.687	.562	.218	.125	Various	-114	.827	.945	.197	.150
Various	-52	.855	.630	.230	.093	Various	-116	.855	.630	.228	.122
TO-220	-54	.750	.500	.187	.147	Various	-117	.827	.709	.256	.126
TO-202	-55	.610	.560	.245	.125	Various	-118	.748	.551	.217	.126
Various	-56	.855	.562	.218	.125	Various	-119	.437	.311	.142	.110
TO-220	-58	.750	.500	.187	.125	Various	-120	.728	.472	.157	.098
TO-126	-60	.437	.312	.140	.122	TO-3P	-122	1.140	.810	.355	.147
Various	-61	.750	.410	.225	.156	Various	-126	.945	.748	.256	.162
TO-220	-62	.750	.600	.240	.150	Various	-128	.984	1.654	.315	.157
Various	-63	.750	.600	.240	.115	Various	-131	.709	.512	.177	.122
Various	-64	.500	.385	.170	.120	Various	-132	.472	.315	.157	.126
TO-218	-68	1.125	.625	.200	.145	Various	-133	.866	.709	.256	.126
Various	-70	1.410	.810	.355	.147	Various	-134	.945	.709	.228	.126
Various	-90	.860	.740	.200	.160	Various	-136	1.250	1.000		
Various	-102	.866	.650	.217	.142	Various	-137	1.250	1.000	.258	.127
Various	-103	.750	.800	.150	.160	Various	-138	1.250	1.000	.258	.148

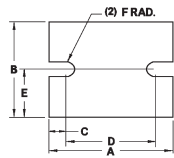

Power Module	Part Number Suffix	"A"	"B"	Dimensions "C"	"D"	"E"	"F"
	-67	1.500	.900	.150	1.200	.450	.075
	-101	2.500	2.000	.344	1.812	1.000	.156

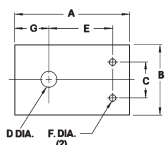

Plastic Power	Part Number Suffix	"A"	"B"	Dimensions "C"	"D"	"E"	"F"	"G"
	-57	.910	.500	.200	.125	.580	.046	.265
	-89	.983	.750	.432	.156	.665	.101	.217

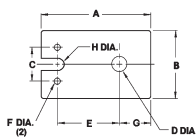

Plastic Power	Part Number Suffix	"A"	"B"	Dimensions "C"	"D"	"E"	"F"	"G"	"H"
	-66	1.000	.500	.200	.141	.626	.046	.219	.032

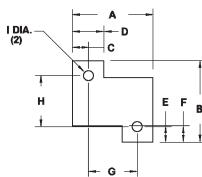

Power Resistors	Part Number Suffix	"A"	"B"	Dimensions "C"	"D"	"E"	"F"	"G"	"H"	"I"
RH-25	-94	1.187	1.205	.234	.469	.212	.156	.719	.781	.140
RH-50	-95	2.093	1.265	.265	.530	.210	.255	1.563	.845	.140
RH-5	-96	.725	.771	.140	.280	.140	.156	.445	.491	.093
RH-10	-97	.805	.890	.127	.250	.130	.190	.551	.630	.121
RH-25	-98	1.150	1.180	.231	.425	.190	.270	.688	.800	.147
RH-50	-99	1.965	1.236	.198	.404	.132	.263	1.569	.972	.130

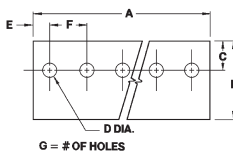

TO-220 Multiples	Part Number Suffix	"A"	"B"	Dimensions "C"	"D"	"E"	"F"	# of Holes
2 Parts	-34	1.000	.750	.187	.125	.250	.500	2
3 Parts	-36	1.500	.750	.187	.125	.250	.500	3
	-37	2.000	.750	.187	.125	.250	.500	4
	-38	2.500	.750	.187	.125	.250	.500	5
	-39	3.000	.750	.187	.125	.250	.500	6
	-40	3.500	.750	.187	.125	.250	.500	7
	-41	4.000	.750	.187	.125	.250	.500	8

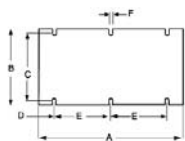

Power Module	Part Number Suffix	"A"	"B"	Dimensions "C"	"D"	"E"	"F"
	-108	4.600	2.400	2.125	.500	1.800	.125
	-140	4.598	2.402	2.098	0.500	1.799	0.150
	-141	2.279	2.402	2.102	0.488	0.650	0.150
	-142	2.280	1.450	1.270	0.490	0.650	0.130

ORDERING

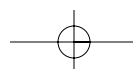

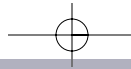

Sil-Pad® Configurations

Imperial Measurements

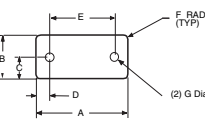
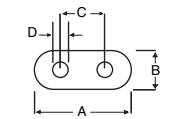
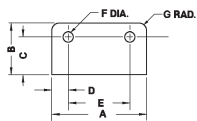
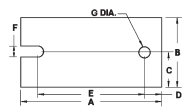
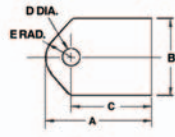
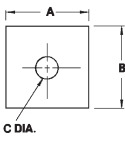
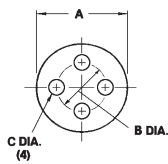
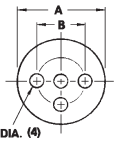
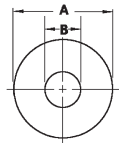
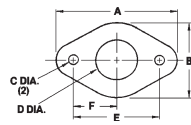
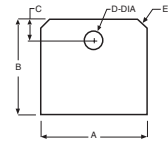

Multiwatt	Part Number Suffix	"A"	"B"	Dimensions "C"	"D"	"E"
	-124	.872	.790	.160	.148	.118 x 45°
	-125	.866	.787	.157	.154	.079 x 45°

Multi-Lead TO-66	Part Number Suffix	"A"	"B"	"C"	"D"	"E"	"F"
	-93	1.350	.800	.140	.400	.960	.480

Diode Washer	Part Number Suffix	Dimensions "A"	"B"	Part Number Suffix	Dimensions "A"	"B"
Various	-19	.510	.140	Various	-.75	.360
DO-4	-20	.510	.200	Various	-.76	.750
DO-5	-21	.800	.260	Various	-.77	.800
DO-4 (oversized)	-22	.625	.200	DO-8	-.78	.875
DO-5 (oversized)	-25	1.000	.260	Various	-.79	1.180
Various	-26	.812	.145	Various	-.80	1.250
Various	-27	.812	.115	Various	-.81	1.500
Various	-28	1.000	.140	Various	-.82	.512
Various	-32	1.500	.500	Various	-1.11	.591

Part Number TO-36	Suffix	"A"	Dimensions "B"	"C"
	-08	1.063	.690	.190

Small Power Devices	Part Number Suffix	"A"	Dimensions "B"	"C"
TO-5, 3 Holes	-09	.360	.200	.040
TO-18, 3 Holes	-12	.250	.100	.036
TO-18, 4 Holes	-13	.250	.100	.036
TO-5, 4 Holes	-33	.360	.200	.040
TO-5, 3 Holes	-44	.390	.200	.040
TO-5, 4 Holes	-45	.390	.200	.040

Rectifier	Part Number Suffix	"A"	Dimensions "B"	"C"
	-46	1.250	1.250	.200
	-47	1.125	1.125	.140
	-48	1.000	1.000	.187

TIP Packages	Part Number Suffix	"A"	"B"	Dimensions "C"	"D"	"E"
Clip Mount	-42	.984	.787			.205
TIP-36						
Plastic Tip	-53	.865	.650	.650	.140	.205
TO-3P	-65	1.260	.787	.984	.142	.205
Plastic Clip	-73	.984	.787	.708	.142	.205

Power Module	Part Number Suffix	"A"	"B"	Dimensions "C"	"D"	"E"	"F"	"G"
	-100	2.510	1.260	.630	.305	1.900	.205	.205
	-123	1.614	1.102	.551	.157	1.220	.118	.118

SIP Package	Part Number Suffix	"A"	"B"	Dimensions "C"	"D"	"E"	"F"	"G"
	-105	1.450	.838	.612	.245	.960	.170	.120

Quartz	Part Number Suffix	"A"	Dimensions "B"	"C"	"D"
	-115	.472	.197	.193	.031

Power Module	Part Number Suffix	"A"	"B"	Dimensions "C"	"D"	"E"	"F"	"G"
	-109	1.350	.642	.321	.195	.960	.060	.125

ORDERING

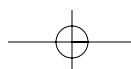

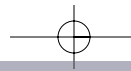

Sil-Pad® Configurations

Imperial Measurements

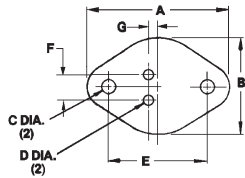

TO-3 & TO-66		Dimensions						
Style	Part Number Suffix	"A"	"B"	"C"	"D"	"E"	"F"	"G"
	-02	1.780	1.250	.140	.093	1.187	.430	.072
	-03	1.563	1.050	.140	.080	1.187	.430	.072
	-04	1.650	1.140	.122	.062	1.187	.430	.072
	-05	1.650	1.140	.140	.093	1.187	.430	.072
	-06	1.650	1.140	.165	.062	1.187	.430	.072
	-07	1.780	1.250	.165	.094	1.187	.430	.072
	-10	1.440	1.000	.140	.075	.960	.200	.100
	-11	1.312	.762	.140	.062	.960	.200	.100
	-15	1.780	1.250	.140	.046	1.187	.430	.072
	-16	2.070	1.560	.122	.062	1.187	.430	.072
	-17	1.650	1.140	.140	.046	1.187	.430	.072
	-18	1.563	1.050	.140	.140	1.187	.430	.072
	-23	1.593	1.100	.156	.062	1.187	.430	.072
	-24	1.700	1.187	.156	.062	1.187	.430	.072
	-29	1.650	1.065	.140	.046	1.187	.430	.072
	-30	1.250	.700	.140	.062	.960	.200	.100
	-31	1.375	.825	.140	.062	.960	.200	.100
	-59 Leadless	1.650	1.140	.165		1.187		
	-112	1.780	1.248	.165	.063	1.185	.429	.073
	-113	1.563	1.051	.165	.079	1.185	.429	.073
	-127	1.307	.819	.165	.063	.909	.236	.061
	-129	1.654	1.063	.138	.059	1.181	.433	.071
	-135	1.650	1.142	.165	.142	1.187	.429	.072

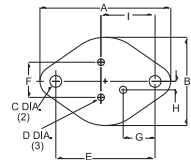

3 Lead TO-3		Dimensions								
Part Number Suffix	"A"	"B"	"C"	"D"	"E"	"F"	"G"	"H"	"I"	
-92	1.650	1.140	.140	.093	1.187	.430	.400	.155	.718	

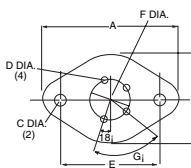

4 Lead TO-3		Dimensions						
Part Number Suffix	"A"	"B"	"C"	"D"	"E"	"F"	"G"	
-86	1.560	1.050	.156	.080	1.170	.470	72°	
-87	1.563	1.050	.156	.063	1.187	.470	72°	

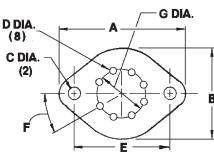

8 Lead TO-3		Dimensions						
Part Number Suffix	"A"	"B"	"C"	"D"	"E"	"F"	"G"	
-88	1.655	1.187	.156	.060	1.187	40°	.500	

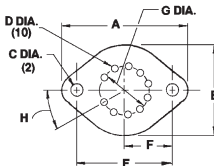

10 Lead TO-3		Dimensions							
Part Number Suffix	"A"	"B"	"C"	"D"	"E"	"F"	"G"	"H"	
-91	1.650	1.140	.165	.040	1.187	.593	.500	32.7°	

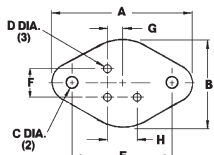

3 Lead TO-66		Dimensions							
Part Number Suffix	"A"	"B"	"C"	"D"	"E"	"F"	"G"	"H"	
-85	1.275	.750	.156	.100	.960	.200	.100	.200	

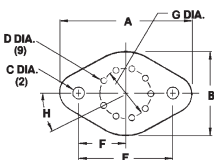

9 Lead TO-66		Dimensions						
Part Number Suffix	"A"	"B"	"C"	"D"	"E"	"F"	"G"	"H"
-83	1.440	1.000	.140	.055	.960	.480	.325	36°

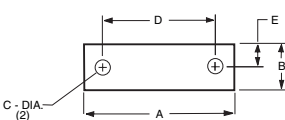

Power Module		Dimensions				
Part Number Suffix	"A"	"B"	"C"	"D"	"E"	
-130	1.600	.480	.165	1.197	.240	

ORDERING

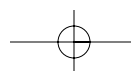

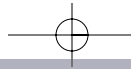

Hi-Flow[®] 225 Configurations

Imperial Measurements

Hi-Flow 225U Tab Configurations

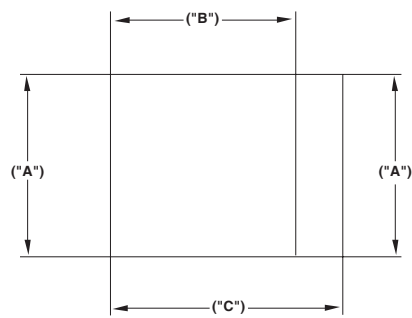
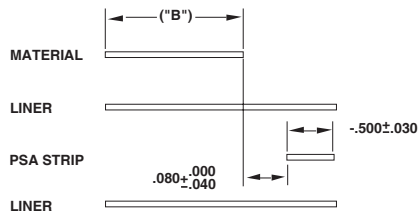

Part Number Suffix	Dimensions (± .015)			Min. Pcs/Roll
	"A"	"B"	"C"	
-143	1.500	1.500	2.500	5000
-144	1.378	1.378	2.378	5000
-145	1.250	1.250	2.250	5000
-146	1.000	1.000	2.000	7500
-147	.700	.700	1.700	10000
-148	.500	.500	1.500	15000
-149	.300	1.000	2.000	22500

Hi-Flow 225UT/225FT Tab Configurations

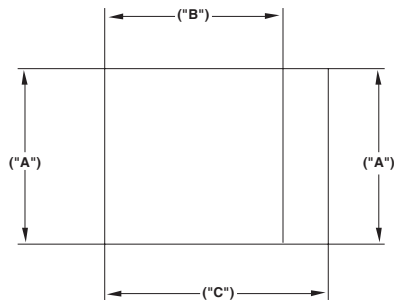
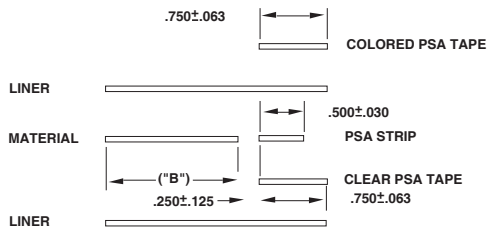

Part Number Suffix	Dimensions (± .015)			Min. Pcs/Roll
	"A"	"B"	"C"	
-150	1.650	1.650	2.650	3000
-151	1.500	1.500	2.500	5000
-152	1.375	1.375	2.375	5000
-153	1.250	1.250	2.250	5000
-154	1.000	1.000	2.000	7500
-155	.700	.700	1.700	10000
-156	.500	.500	1.500	15000

ORDERING

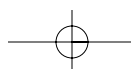

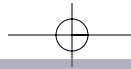

Sil-Pad® Configurations

Metric Measurements

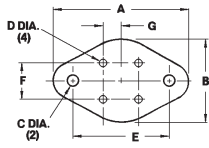

4 Lead TO-66	Part Number Suffix	"A"	"B"	"C"	Dimensions "D"	"E"	"F"	"G"
	-84	33.32	19.35	3.56	1.57	24.38	5.08	2.54

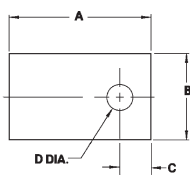

TO-220

Plastic Power	Part Number Suffix	"A"	"B"	Dimensions "C"	"D"	Part Number Suffix	"A"	Dimensions "B"	"C"	"D"	
Various	-35	18.03	12.70	4.06	3.58	Various	-104	25.40	19.05	7.62	3.56
(Clip Mount)	-43	19.05	12.70			Various	-107	20.57	23.11	4.32	3.73
TO-126	-50	11.10	7.92	3.56	2.36	Various	-110	24.99	19.99		
Various	-51	17.45	14.27	5.54	3.18	Various	-114	21.01	24.00	5.00	3.81
Various	-52	21.72	16.00	5.84	2.36	Various	-116	21.72	16.00	5.79	3.10
TO-220	-54	19.05	12.70	4.75	3.73	Various	-117	21.01	18.01	6.50	3.20
TO-202	-55	15.49	14.22	6.22	3.18	Various	-118	19.00	14.00	5.51	3.20
Various	-56	21.72	14.27	5.54	3.18	Various	-119	11.10	7.90	3.61	2.79
TO-220	-58	19.05	12.70	4.75	3.18	Various	-120	18.49	11.99	3.99	2.49
TO-126	-60	11.10	7.92	3.56	3.10	TO-3P	-122	28.96	20.57	9.02	3.73
Various	-61	19.05	10.41	5.72	3.96	Various	-126	24.00	19.00	6.50	4.11
TO-220	-62	19.05	15.24	6.10	3.81	Various	-128	24.99	42.01	8.00	3.99
Various	-63	19.05	15.24	6.10	2.92	Various	-131	18.01	13.00	4.50	3.10
Various	-64	12.70	9.78	4.32	3.05	Various	-132	11.99	8.00	3.99	3.20
TO-218	-68	28.58	15.88	5.08	3.68	Various	-133	22.00	18.01	6.50	3.20
Various	-70	35.81	20.57	9.02	3.73	Various	-134	24.00	18.01	5.79	3.20
Various	-90	21.84	18.80	5.08	4.06	Various	-136	31.75	25.40		
Various	-102	22.00	16.51	5.51	3.61	Various	-137	31.75	25.40	6.55	3.23
Various	-103	19.05	20.32	3.81	4.06	Various	-138	31.75	25.40	6.55	3.76

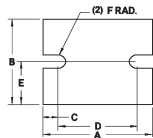

Power Module	Number Suffix	"A"	"B"	Dimensions "C"	"D"	"E"	"F"
	-67	38.10	22.86	3.81	30.48	11.43	1.90
	-101	63.50	50.80	8.74	46.02	25.40	3.96

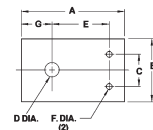

Plastic Power	Part Number Suffix	"A"	"B"	"C"	Dimensions "D"	"E"	"F"	"G"
	-57	23.11	12.70	5.08	3.18	14.73	1.17	6.73
	-89	24.97	19.05	10.97	3.96	16.89	2.57	5.51

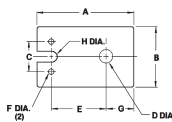

Plastic Power	Part Number Suffix	"A"	"B"	"C"	Dimensions "D"	"E"	"F"	"G"	"H"
	-66	25.40	12.70	5.08	3.58	15.90	1.17	5.56	0.81

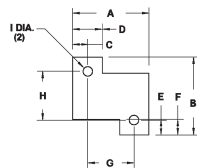

Power Resistor	Part Number Suffix	"A"	"B"	"C"	"D"	Dimensions "E"	"F"	"G"	"H"	"I"
RH-25	-94	30.15	30.61	5.94	11.91	5.38	3.96	18.26	19.84	3.56
RH-50	-95	53.16	32.13	6.73	13.46	5.33	6.48	39.70	21.46	3.56
RH-5	-96	18.42	19.58	3.56	7.11	3.56	3.96	11.30	12.47	2.36
RH-10	-97	20.45	22.61	3.23	6.35	3.30	4.83	14.00	16.00	3.07
RH-25	-98	29.21	29.97	5.87	10.80	4.83	6.86	17.48	20.32	3.73
RH-50	-99	49.91	31.39	5.03	10.26	3.35	6.68	39.85	24.69	3.30

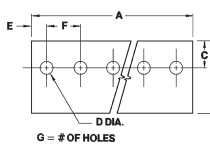

TO-220 Multiples	Part Number Suffix	"A"	"B"	Dimensions "C"	"D"	"E"	"F"	# of Holes
2 Parts	-34	25.40	19.05	4.75	3.18	6.35	12.70	2
3 Parts	-36	38.10	19.05	4.75	3.18	6.35	12.70	3
	-37	50.80	19.05	4.75	3.18	6.35	12.70	4
	-38	63.50	19.05	4.75	3.18	6.35	12.70	5
	-39	76.20	19.05	4.75	3.18	6.35	12.70	6
	-40	88.90	19.05	4.75	3.18	6.35	12.70	7
	-41	101.60	19.05	4.75	3.18	6.35	12.70	8

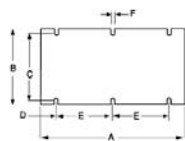

Power Module	Part Number Suffix	"A"	"B"	Dimensions "C"	"D"	"E"	"F"
	-108	116.84	60.96	53.97	12.70	45.72	3.18
	-140	116.8	61.00	53.30	12.70	45.70	3.80
	-141	57.90	61.00	53.40	12.40	16.50	3.80
	-142	57.91	36.83	32.26	12.45	16.50	3.30

ORDERING

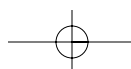

Sil-Pad® Configurations

Metric Measurements

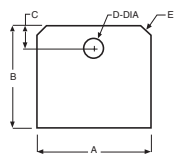

Multiwatt	Part Number Suffix	"A"	"B"	Dimensions "C"	"D"	"E"
	-124	22.15	20.07	4.06	3.76	3.0 x 45°
	-125	22.00	19.99	3.99	3.91	2.0 x 45°

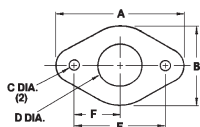

Multi-Lead TO-66	Part Number Suffix	"A"	"B"	Dimensions "C"	"D"	"E"	"F"
	-93	34.29	20.32	3.56	10.16	24.38	12.19

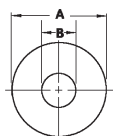

Diode Washer	Part Number Suffix	Dimensions "A"	"B"	Part Number Suffix	Dimensions "A"	"B"
Various	-19	12.95	3.56	Various	-75	9.14
DO-4	-20	12.95	5.08	Various	-76	19.05
DO-5	-21	20.32	6.60	Various	-77	20.32
DO-4 (oversized)	-22	15.88	5.08	DO-8	-78	22.23
DO-5 (oversized)	-25	25.40	6.60	Various	-79	29.97
Various	-26	20.62	3.68	Various	-80	31.75
Various	-27	20.62	2.92	Various	-81	38.10
Various	-28	25.40	3.56	Various	-82	13.00
Various	-32	38.10	12.70	Various	-111	15.01

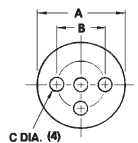

TO-36	Part Number Suffix	Dimensions "A"	"B"	"C"
	-08	27.00	17.53	4.83

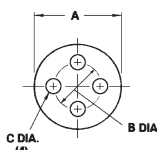

Small Power Devices	Part Number Suffix	Dimensions "A"	"B"	"C"
TO-5, 3 Holes	-09	9.14	5.08	1.02
TO-18, 3 Holes	-12	6.35	2.54	0.91
TO-18, 4 Holes	-13	6.35	2.54	0.91
TO-5, 4 Holes	-33	9.14	5.08	1.02
TO-5, 3 Holes	-44	9.91	5.08	1.02
TO-5, 4 Holes	-45	9.91	5.08	1.02

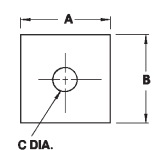

Rectifier	Part Number Suffix	Dimensions "A"	"B"	"C"
	-46	31.75	31.75	5.08
	-47	28.58	28.58	3.56
	-48	25.40	25.40	4.75

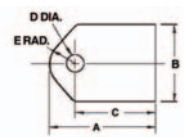

TIP Packages	Part Number Suffix	"A"	"B"	Dimensions "C"	"D"	"E"
Clip Mount	-42	24.99	19.99			5.21
TIP-36 Plastic Tip	-53	21.97	16.51	16.51	3.56	5.21
TO-3P	-65	32.00	19.99	24.99	3.61	5.21
Plastic Clip	-73	24.99	19.99	17.98	3.61	5.21

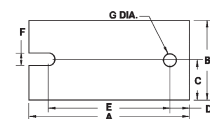

Power Module	Part Number Suffix	"A"	"B"	Dimensions "C"	"D"	"E"	"F"	"G"
	-100	63.75	32.00	16.00	7.75	48.26	5.21	5.21
	-123	41.00	27.99	14.00	3.99	30.99	3.00	3.00

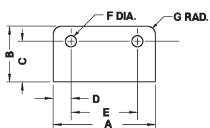

SIP Package	Part Number Suffix	"A"	"B"	Dimensions "C"	"D"	"E"	"F"	"G"
	-105	36.83	21.29	15.54	6.22	24.38	4.32	3.05

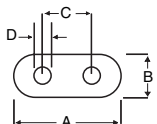

Power Module	Part Number Suffix	"A"	"B"	Dimensions "C"	"D"
	-115	11.99	5.00	4.90	0.79

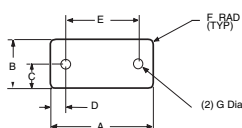

Power Module	Part Number Suffix	"A"	"B"	Dimensions "C"	"D"	"E"	"F"	"G"
	-109	34.29	16.31	8.15	4.95	24.38	1.52	3.18

ORDERING

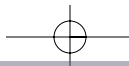

Sil-Pad® Configurations

TO-3 Style	Part Number Suffix	Dimensions							Metric Measurements		
		"A"	"B"	"C"	"D"	"E"	"F"	"G"			
	-02	45.21	31.75	3.56	2.36	30.15	10.92	1.83			
	-03	39.70	26.67	3.56	2.03	30.15	10.92	1.83			
	-04	41.91	28.96	3.10	1.57	30.15	10.92	1.83			
	-05	41.91	28.96	3.56	2.36	30.15	10.92	1.83			
	-06	41.91	28.96	4.19	1.57	30.15	10.92	1.83			
	-07	45.21	31.75	4.19	2.39	30.15	10.92	1.83			
	-10	36.58	25.40	3.56	1.90	24.38	5.08	2.54			
	-11	33.32	19.35	3.56	1.57	24.38	5.08	2.54			
	-15	45.21	31.75	3.56	1.17	30.15	10.92	1.83			
	-16	52.58	39.62	3.10	1.57	30.15	10.92	1.83			
	-17	41.91	28.96	3.56	1.17	30.15	10.92	1.83			
	-18	39.70	26.67	3.56	3.56	30.15	10.92	1.83			
	-23	40.46	27.94	3.96	1.57	30.15	10.92	1.83			
	-24	43.18	30.15	3.96	1.57	30.15	10.92	1.83			
	-29	41.91	27.05	3.56	1.17	30.15	10.92	1.83			
	-30	31.75	17.78	3.56	1.57	24.38	5.08	2.54			
	-31	34.92	20.96	3.56	1.57	24.38	5.08	2.54			
	-59 Leadless	41.91	28.96	4.19		30.15					
	-112	45.21	31.70	4.19	1.60	30.10	10.90	1.85			
-113	39.70	26.70	4.19	2.01	30.10	10.90	1.85				
-127	33.20	20.80	4.19	1.60	23.09	5.99	1.55				
-129	42.01	27.00	3.51	1.50	30.00	11.00	1.80				
-135	41.91	29.01	4.19	3.61	30.15	10.90	1.83				
3 Lead TO-3	Part Number Suffix	"A"	"B"	"C"	Dimensions "D"		"E"	"F"	"G"	"H"	"I"
	-92	41.91	28.96	3.56	2.36	30.15	10.92	10.16	3.94	18.24	
4 Lead TO-3	Part Number Suffix	"A"	"B"	"C"	Dimensions "D"		"E"	"F"	"G"		
	-86	39.62	26.67	3.96	2.03	29.72	11.94	72°			
	-87	39.70	26.67	3.96	1.60	30.15	11.94	72°			
8 Lead TO-3	Part Number Suffix	"A"	"B"	"C"	Dimensions "D"		"E"	"F"	"G"		
	-88	42.04	30.15	3.96	1.52	30.15	40°	12.70			
10 Lead TO-3	Part Number Suffix	"A"	"B"	"C"	Dimensions "D"		"E"	"F"	"G"	"H"	
	-91	41.91	28.96	4.19	1.02	30.15	15.06	12.70	32.7°		
3 Lead TO-66	Part Number Suffix	"A"	"B"	"C"	Dimensions "D"		"E"	"F"	"G"	"H"	
	-85	32.38	19.05	3.96	2.54	24.38	5.08	2.54	5.08		
9 Lead TO-66	Part Number Suffix	"A"	"B"	"C"	Dimensions "D"		"E"	"F"	"G"	"H"	
	-83	36.58	25.40	3.56	1.40	24.38	12.19	8.26	36°		
Power Module	Part Number Suffix	"A"	"B"	"C"	Dimensions "D"		"E"				
	-130	40.64	12.19	4.19	30.40	6.10					

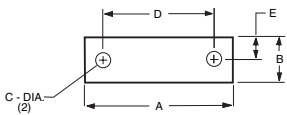
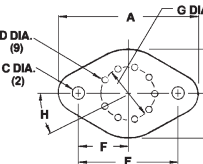
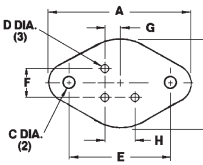
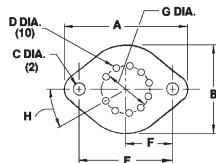
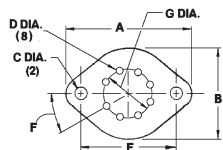
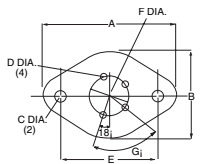
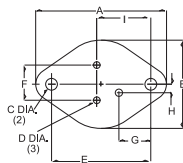
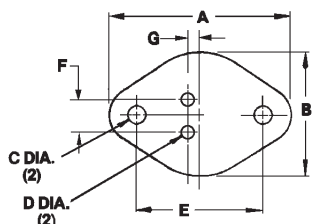

ORDERING

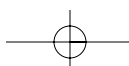

Hi-Flow[®] 225 Configurations

Metric Measurements

Hi-Flow 225U Tab Configurations

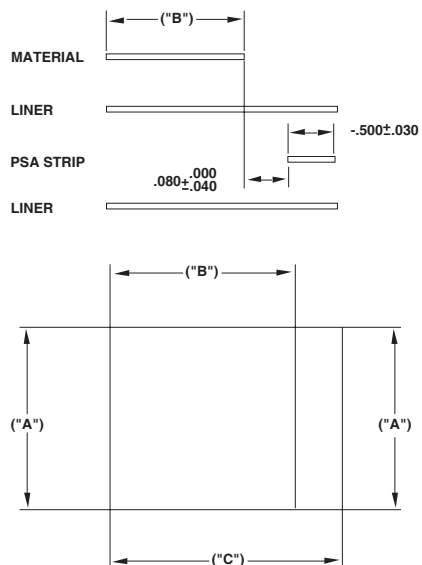

Part Number Suffix	Dimensions ($\pm .015$)			Min. Pcs/Roll
	"A"	"B"	"C"	
-143	38.10	38.10	63.50	5000
-144	35.00	35.00	60.40	5000
-145	31.75	31.75	57.15	5000
-146	25.40	25.40	50.80	7500
-147	17.78	17.78	43.18	10000
-148	12.70	12.70	38.10	15000
-149	7.62	7.62	50.80	22500

Hi-Flow 225UT/225FT Tab Configurations

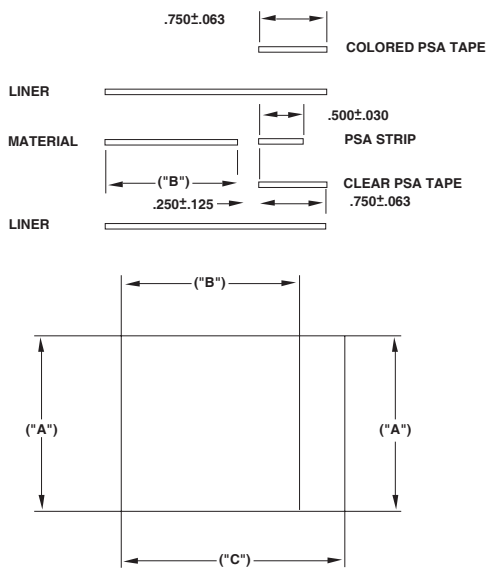

Part Number Suffix	Dimensions ($\pm .015$)			Min. Pcs/Roll
	"A"	"B"	"C"	
-150	41.91	41.91	67.31	3000
-151	38.10	38.10	63.50	5000
-152	34.93	34.93	60.33	5000
-153	31.75	31.75	57.15	5000
-154	25.40	25.40	50.80	7500
-155	17.78	17.78	43.18	10000
-156	12.70	12.70	38.10	15000

ORDERING

Sil-Pad® Shield

Standard Configurations

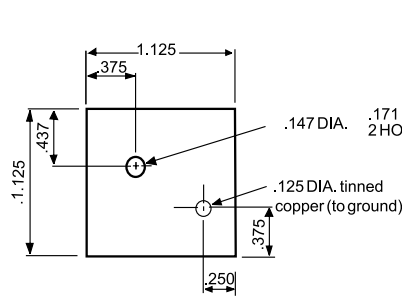

P/N 09SPS01-002 (TO-220)

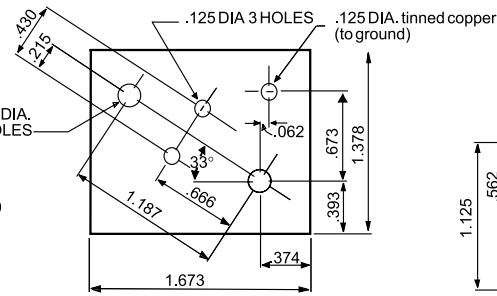

P/N 09SPS01-001 (TO-3)

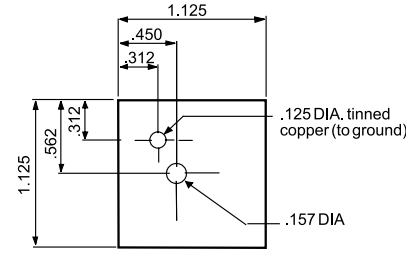

P/N 09SPS01-009

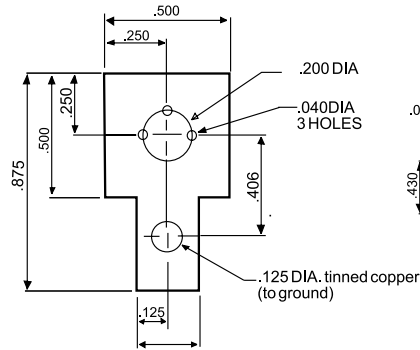

P/N 09SPS01-011 (TO-5)

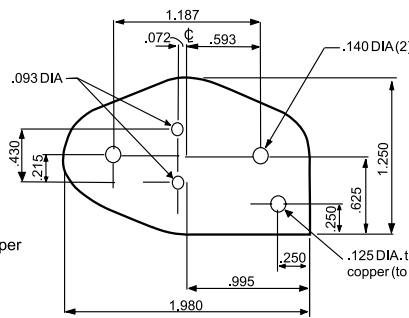

P/N 09SPS01-016 (TO-3)

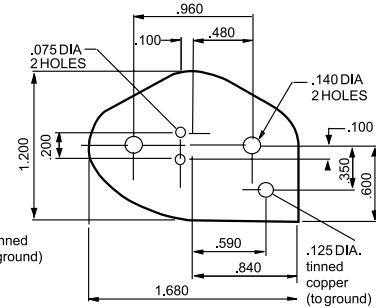

P/N 09SPS01-017 (TO-66)

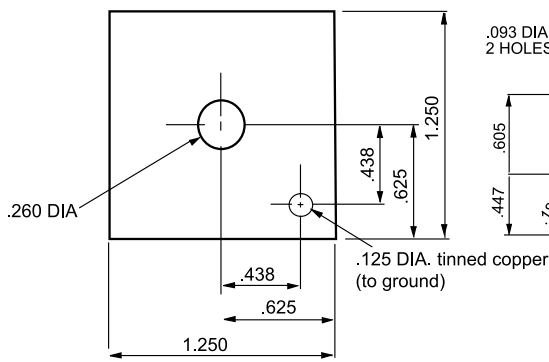

P/N 09SPS01-020 (DO-5)

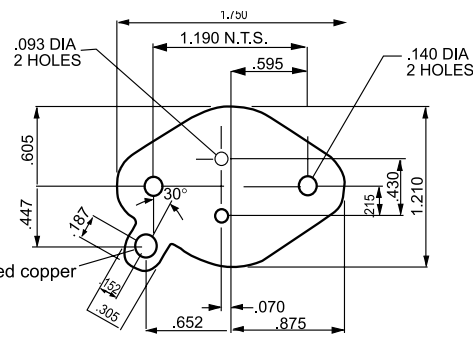

P/N 09SPS01-023 (TO-3)

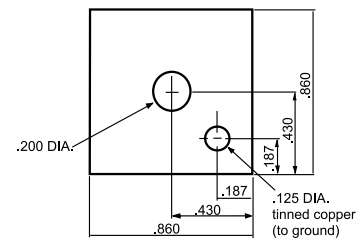

P/N 09SPS01-019 (DO-4)

Contact the factory for other configurations.

ORDERING

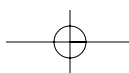
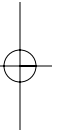
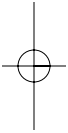
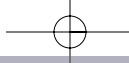

X-ON Electronics

Largest Supplier of Electrical and Electronic Components

Click to view similar products for [bergquist company manufacturer](#):

Other Similar products are found below :

[SIL-PAD 2000 150MMX150MM SHEET](#) [GP2000S40-0.040-02-4/4](#) [GPEMI1.0-0.060-01-0816](#) [SPA2000-0.020-00-1012](#) [TGP6000ULM-0.125-12-0816](#) [803265](#) [GPEMI1.0-0.040-01-0816](#) [GP3500ULM-G-0.100-12-0816](#) [TGP12000ULM-0.080-00-0808](#) [GP1500-0.160-02-0816](#) [TGP3000ULM-0.080-02-0816](#) [SIL-PAD K6 300MMX300MM SHEET](#) [GP1500-0.200-02-0816](#) [SP980-0.009-00-1212](#) [GPEMI1.0-0.100-01-0816](#) [GPA3000-0.125-01-0816](#) [TGP12000ULM-0.100-00-0808](#) [TGP12000ULM-0.060-00-0808](#) [TGP3000ULM-0.120-02-0816](#) [803263](#) [GP1000SF-0.100-02-0816](#) [GPHC1000-0.010-02-0816](#) [GP1500S30-0.100-02-0816](#) [LF2000-00-00-30CC](#) [TGP3000ULM-0.100-02-0816](#) [TGP12000ULM-0.125-00-0808](#) [803269](#) [2015-54](#) [GPVOUS-0.080-00-4/4](#) [SP1200-0.016-AC-1212](#) [HF625-0.005-AC-1212](#) [SPA1500-0.010-00-4/4](#) [GP1500S30-0.250-02-0816](#) [SPA2000-0.015-AC-1012](#) [GP3500ULM-G-0.080-12-0816](#) [GPVO-0.160-01-0816](#) [GP1500S30-0.125-02-0816](#) [BP660P-0.008-00-1112](#) [LF3800LVO-00-150CC](#) [803790](#) [803266](#) [BP100-0.005-00-1/1](#) [SP1200-0.012-AC-1212](#) [SP1500ST-0.012-02-1012](#) [GP3500ULM-0.100-02-0816](#) [GF2000-00-600-50CC](#) [803262](#) [GPVOUS-0.160-AC-0816](#) [GPVOUS-B-0.040-01-0816](#) [803268](#)