



BERNSTEIN
TOOLS FOR ELECTRONICS



PLIERS, STRIPPING AND CRIMPING TOOLS

They perform well

GET IN CONTACT WITH US

BERNSTEIN
Werkzeugfabrik
Steinrücke GmbH
Industriehof Trecknase 1
42897 Remscheid

Tel. + 49 (0) 2191 - 9650 - 0
Fax + 49 (0) 2191 - 9650 - 30

sales@bernstein-tools.de

VISIT US ON THE WEB

We update our product information on a regular basis and automatically using our Product Information System. This enables the quick and up-to-date compilation of customer-specific data feeds for your own digital sale activities. Take advantage of this service and always keep Bernstein product information up to date!

Product videos and blog posts round off our online offering. Furthermore, we also respect the traditional sales channel via specialist retailers and offer the option to present your webshop as an online sales platform for products by BERNSTEIN.

www.bernstein-tools.de

SYMBOL LEGEND**NEW**

New product



Number of tools in sets



Weight



Dimensions



ESD protection (EPA suitable)



VDE tested

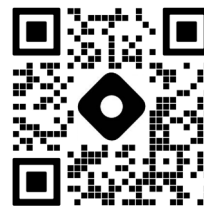



PLIERS – THEY PERFORM WELL

BERNSTEIN mainly offers electronics pliers for professional demands which are characterised by their consistent quality and a long service life. Our series of pliers differ from each other due to their different production methods and properties.

The EUROLINE, CLASSICline und BLACKline series of pliers are made from high-quality blanks which are hot forged in a die and inserted through the die. The pliers are oil hardened and the tips receive additional inductive hardening.

The TECHNICLINE series of pliers are cut by laser from ball bearing steel and further processed and refined in CNC machining centres, allowing us to achieve a particularly stable microstructure with enormous cutting performance.

This is why our pliers are suitable for cutting all types of wire.

The tensile strength (soft, semi-hard, hard wire) is crucial for common resistance wire, solder wire, winding wire or heating wire (thermocouple wire). Particularly for copper wire, brass wire, steel wire, iron wire, aluminium wire, bond wire, tin wire, nickel wire, gold wire, silver wire, platinum wire, tungsten-copper wire, tungsten wire, glass fibre and even Kevlar.

Please note the cutting value given in the packaging of the pliers as well as the care instructions for a long service life.

DIFFERENCES OF THE PLIERS

MATERIALS

Depending on the model and the requirements, we use high-alloyed tool steels or high-grade ball bearing steel (chrome steel) from selected suppliers.

CONSTRUCTION

We manufacture pliers with four different joint constructions (joint) depending on the application and design of the pliers.

Lay-on joint

The simplest form for joining the two halves of a pair of pliers is the lap joint. Here, the levers are put on top of each other and connected by a hinge pin. This construction is only used for very crude pliers.

Lap joint

For a single joint, the joint surfaces are also milled out so that the halves fit into one another and can be connected using a hinge pin.

Box joint

The most complex construction is the box joint. In a very special process, one lever is passed through the joint of the other lever which is opened using heat. The joint is then pressed together and connected with a pin. This construction ensures the best parallel motion of the tips and an extremely long service life.

Screw joint

The screw joint is manufactured with highly precise joint surfaces, ensuring smooth motion of the pliers and a uniform, low-friction open-close movement. In combination with the basic hardness of the high-quality chrome-vanadium ball bearing steel, the screw design provides a very high cutting performance with a long service life.



LAY-ON JOINT



LAP JOINT



BOX JOINT



SCREWED JOINT

GRAPHIC REPRESENTATION
OF THE JOINTS

SURFACES

Over the decades we have developed surface properties that meet the wide ranging applications and requirements arising in daily use.

This involves properties such as corrosion protection, hardness, abrasion, spalling, smoothness and surface roughness in order to ensure the optimal work results.

CUTTING SHAPE AND CUTTING PERFORMANCE

The service life of the cutting tips depends on their sharpness. The sharper the edge (full flush) the quicker the wear. That's why semi-flush pliers are preferable as long as flush or shock-reducing cutting is not required.

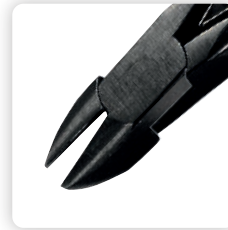

BURNISHED
(free of glare and reflections)



HIGH-GLOSS STEEL POLISHED

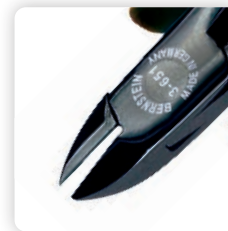

FINE POLISHED AND GLOSSY BURNISHED
(free of glare and reflections)

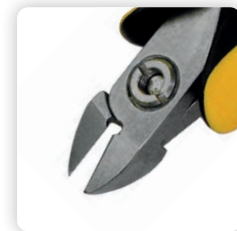

MATT FINISH
(free of glare and reflections)

Semi flush

This can be used for hard and soft steel wires and soft materials, such as copper wire. The cut leaves a pyramid-like tip at the end of the wire.



SEMI FLUSH

Flush

This provides an almost flush cut. It can be used for soft steel wires and copper wire. The cut is slightly shock reduced. It only leaves a very small tip at the end of the wire.



FLUSH

Full flush

This cuts completely flush and provides an extremely sharp cut. It is used exclusively for soft steel wires and copper wire and has a largely shock-reducing cut. It cuts absolutely plane-parallel.



FULL FLUSH

Special flush

This is used to cut glass fibre, Kevlar, etc. Fitted with carbide insert. Inserted with hard metal tips, designed for constant stress. These are also for tough nickel, electrode and tungsten wires.



SPECIAL FLUSH

WIRE QUALITIES AND SYMBOLS

(N/mm² = tensile strength)

- soft wire: 220 - 250 N/mm²
- ◌ medium hard wire: 750 - 800 N/mm²
- hard wire: 1600 - 1800 N/mm²
- Ⓟ Piano wire: 2200 - 2300 N/mm²

ESD ELECTRONIC PLIERS BLACKLINE

The pliers in the BLACKline series are characterised by their dip-insulated slender grips. They benefit from a comfortable feel and the pliers do not slip when held. They give the feeling that you are working very close to the workpiece and allow you to control cutting in an optimal manner.

The slim heads are ideal for working on delicate components and feature a highly polished, corrosion-resistant surface. The smooth, box-jointed or single-jointed construction (depending on the model) guarantees a long service life if cared for properly.

The pliers have been tested with great results in accordance with DIN EN 61340-5-1, 61340-2-1 and 61340-2-3 as well as for work in ESD protected areas.



The following types are available, specifications in mm:

Art.-No.	Short description	Type	Flush	Cutting values				Head width	Cutting length	Total length	Weight in g
				○	◐	●	⊕				
▶ CUTTING PLIERS											
3-901-7	ESD side cutters	–	Semi flush	1.5	1.0	0.4	–	12	10	115	65
3-902-7	ESD side cutters	–	Flush	1.5	1.0	–	–	12	10	120	65
3-905-7	ESD top cutters	–	Flush	0.8	0.6	–	–	13	3 x 20*	135	75
3-906-7	ESD end cutters	–	Flush	0.8	0.6	–	–	13	7 x 25*	125	75
▶ HOLDING PLIERS											
									*jaw length		
3-932-7	ESD flat nose pliers	not serrated jaws	–	–	–	–	–	11.5	21.5	120	60
3-933-7	ESD snipe nose pliers	not serrated jaws	–	–	–	–	–	11.5	23	125	60
3-945-7	ESD snipe nose pliers	serrated jaws	–	–	–	–	–	12.5	12.5	145	85



► **3-960**
ESD pliers set BLACKline 4 pcs

320 x 150 x 20 mm
Weight: 345 g

Art.-No.	Content
3-960-0	ESD dissipative bag 4 empty compartments
3-901-7	ESD side cutters BLACKline semi flush 115 mm
3-906-7	ESD end cutters BLACKline flush 125 mm
3-932-7	ESD flat nose pliers BLACKline not serrated jaws 120 mm
3-933-7	ESD snipe nose pliers BLACKline not serrated jaws 125 mm



► **3-960-VB**
ESD tool kit BLACKline VARIO 6 pcs

150 x 190 x 80 mm
Weight: 750 g

Art.-No.	Content
5-090-0	ESD tool holder VARIO 8 slots
3-901-7	ESD side cutters BLACKline semi flush 115 mm
3-906-7	ESD end cutters BLACKline flush 125 mm
3-932-7	ESD flat nose pliers BLACKline not serrated jaws 120 mm
3-933-7	ESD snipe nose pliers BLACKline not serrated jaws 125 mm
5-078-13	ESD SMD universal tweezers 130 mm form PSF stainless steel, dissipative
5-055-13	ESD SMD tweezers 120 mm form 7a stainless steel angle 40°, dissipative



ESD ELECTRONIC PLIERS CLASSICLINE

The pliers in the CLASSICline series are characterised by their high-gloss electropolished surface, which is very resistant to corrosion, without friction and microcracks, extremely smooth and free of particles.

The heads are ideal for working on small components. The pliers sit perfectly in the hand thanks to their two-component protective covering, which is ergonomically shaped, dissipative and features an individually adjustable double leaf spring. The smooth box joint guarantees a long service if cared for properly.

The pliers have been tested with great results in accordance with DIN EN 61340-5-1, 61340-2-1 and 61340-2-3, as well as for work in ESD protected areas.

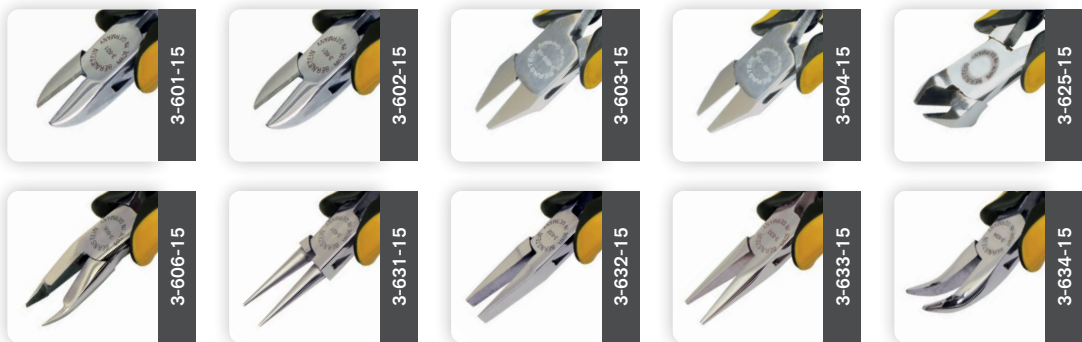

The following types are available, specifications in mm:

Art.-No.	Short description	Type	Flush	○	◐	●	⊕	Head width	Cutting length	Total length	Weight in g
▶ CUTTING PLIERS											
3-601-15	ESD side cutters	-	Semi flush	1.5	1.1	0.5	-	11	13	115	65
3-602-15	ESD side cutters	-	Flush	1.5	1.1	-	-	11	13	115	65
3-603-15	ESD side cutters	-	Semi flush	1.3	1.0	0.4	-	11	13	115	65
3-604-15	ESD side cutters	-	Flush	1.3	0.8	-	-	11	13	115	65
3-606-15	ESD side cutters	-	Flush	0.6	0.8	-	-	10.5	6	120	55
3-625-15	ESD oblique top cutters	-	Flush	1.5	0.8	0.8	-	11	11	120	90
3-627-15	ESD top cutters	-	Flush	1.5	0.8	0.5	-	11	11	120	90
▶ HOLDING PLIERS											
									jaw length		
3-631-15	ESD round nose pliers	not serrated jaws	-	-	-	-	-	10	20	120	55
3-632-15	ESD flat nose pliers	not serrated jaws	-	-	-	-	-	9	18.5	120	55
3-633-15	ESD snipe nose pliers	not serrated jaws	-	-	-	-	-	9.5	17.5	120	55
3-634-15	ESD snipe nose pliers	not serrated jaws	-	-	-	-	-	9.5	22.5	120	55

▶ **3-650-V**
ESD pliers set CLASSICline VARIO 5 pcs

150 x 190 x 80 mm
 Weight: 750 g

Art.-No.	Content
5-090-0	ESD tool holder VARIO 8 slots
3-601-15	ESD side cutters CLASSICline semi flush 115 mm
3-631-15	ESD round nose pliers CLASSICline not serrated jaws 120 mm
3-632-15	ESD flat nose pliers CLASSICline not serrated jaws 120 mm
3-633-15	ESD snipe nose pliers CLASSICline not serrated jaws 120 mm
3-634-15	ESD snipe nose pliers CLASSICline not serrated jaws 120 mm



▶ **3-960-VC**
ESD tool kit CLASSICline VARIO 6 pcs

150 x 180 x 80 mm
 Weight: 700 g

Art.-No.	Content
5-090-0	ESD tool holder VARIO 8 slots
3-601-15	ESD side cutters CLASSICline semi flush 115 mm
3-606-15	ESD side cutters CLASSICline flush 120 mm
3-632-15	ESD flat nose pliers CLASSICline not serrated jaws 120 mm
3-633-15	ESD snipe nose pliers CLASSICline not serrated jaws 120 mm
5-078-13	ESD SMD universal tweezers 130 mm form PSF stainless steel dissipative
5-055-13	ESD SMD tweezers 120 mm form 7a stainless steel angle 40° dissipative



▶ **3-960-C**
ESD pliers set CLASSICline 4 pcs

320 x 150 x 20 mm
 Weight: 380 g

Art.-No.	Content
3-960-0	ESD dissipative bag 4 empty compartments
3-601-15	ESD side cutters CLASSICline semi flush 115 mm
3-606-15	ESD side cutters CLASSICline flush 120 mm
3-632-15	ESD flat nose pliers CLASSICline not serrated jaws 120 mm
3-633-15	ESD snipe nose pliers CLASSICline not serrated jaws 120 mm





ESD ELECTRONIC PLIERS EUROLINE

The pliers in the EUROLINE series are characterised by the precision in manufacturing. The delicate, highly precise heads are produced by hand in a series of work steps. They are highly suitable for working on the smallest components or for cutting fine, strong wires. The high-gloss burnished surface guarantees resistance to corrosion and glare-free, fatigue-free work under the magnifier or microscope.

The pliers sit perfectly in the hand thanks to their two-component protective covering, which is ergonomically shaped, dissipative and features an individually adjustable double leaf spring. The smooth box joint guarantees a long service if cared for properly.

The pliers have been tested with great results in accordance with DIN EN 61340-5-1, 61340-2-1 and 61340-2-3, as well as for work in ESD protected areas.

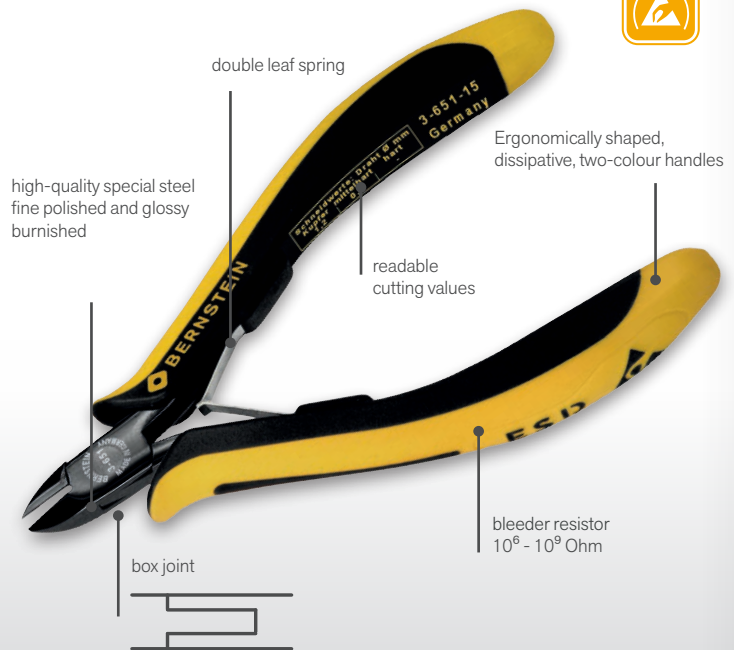

► 3-960-E ESD pliers set EUROLINE 4 pcs

320 x 150 x 20 mm

Weight: 375 g

Also available as ESD dissipative zipper pocket Art.-No. 3-680.

Art.-No.	Content
3-960-0	ESD dissipative bag 4 empty compartments
3-651-15	ESD mini side cutters EUROLINE flush 120 mm
3-672-15	ESD end cutters EUROLINE flush 130 mm
3-682-15	ESD flat nose pliers EUROLINE not serrated jaws 130 mm
3-683-15	ESD snipe nose pliers EUROLINE not serrated jaws 130 mm



► 3-960-VE ESD tool kit EUROLINE VARIO 6 pcs

150 x 190 x 80 mm

Weight: 750 g

Art.-No.	Content
5-090-0	ESD tool holder VARIO 8 slots
3-651-15	ESD mini side cutters EUROLINE flush 120 mm
3-672-15	ESD end cutters EUROLINE flush 130 mm
3-682-15	ESD flat nose pliers EUROLINE not serrated jaws 130 mm
3-683-15	ESD snipe nose pliers EUROLINE not serrated jaws 130 mm
5-078-13	ESD SMD universal tweezers 130 mm form PSF stainless steel dissipative
5-055-13	ESD SMD tweezers 120 mm form 7a stainless steel angle 40° dissipative



► 3-960-ES ESD pliers set EUROLINE 3 pcs

without container, loosely packed

Weight: 200 g

Art.-No.	Content
3-651-15	ESD mini side cutters EUROLINE flush 120 mm
3-672-15	ESD end cutters EUROLINE flush 130 mm
3-683-15	ESD snipe nose pliers EUROLINE not serrated jaws 130 mm

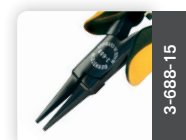
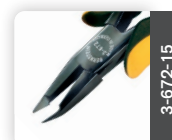

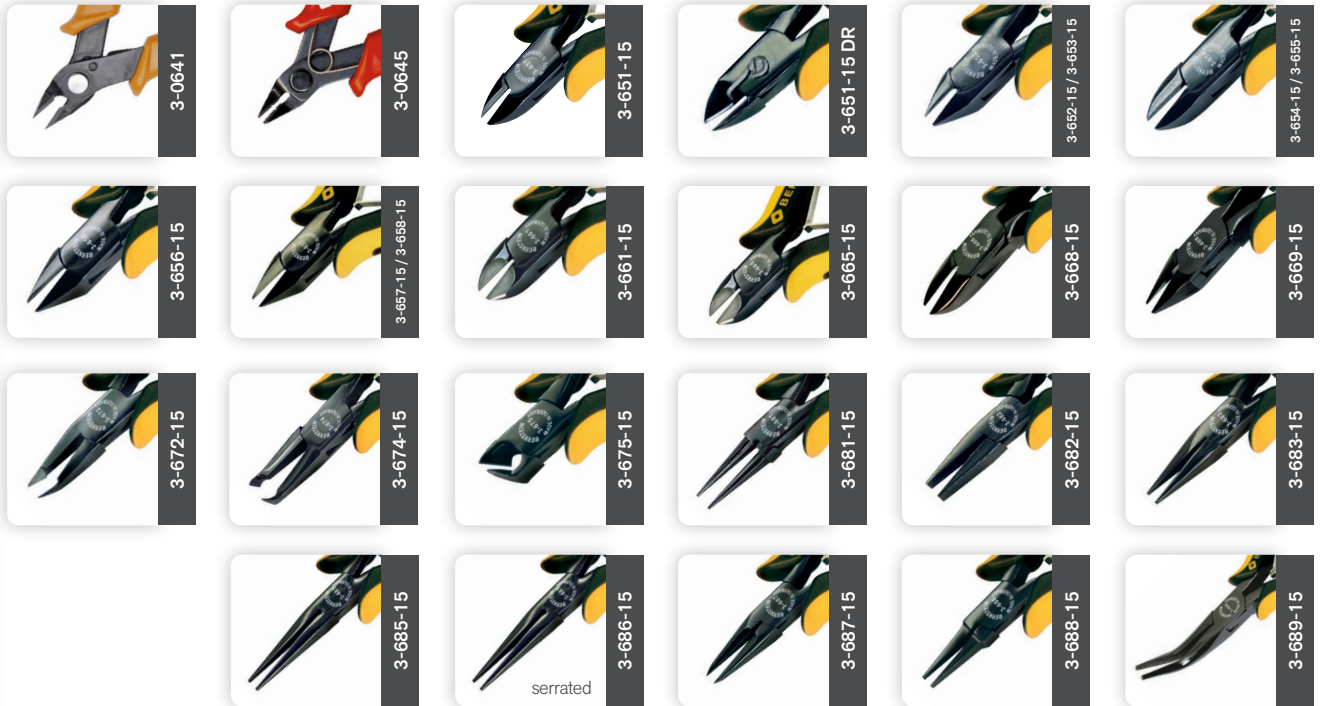

The following types are available, specifications in mm:

Art.-No.	Short description	Type	Flush	Cutting values				Head width	Cutting length	Total length	Weight in g
				○	◐	●	Ⓟ				
▶ CUTTING PLIERS											
3-0641	ESD mini side cutters		Full flush	1	0	0	0	10	10	130	0
3-0645	Stripping mini side cutters		Full flush	0,8	0	0	0	10	8	130	80
3-651-15	ESD mini side cutters	-	Flush	1.5	0.8	-	-	10	9.5	120	65
3-651-15 DR	ESD mini side cutters	with wire holder	Flush	1.5	0.8	-	-	10	9.5	120	65
3-652-15	ESD mini side cutters	-	Flush	1.5	0.8	-	-	10	10	120	60
3-653-15	ESD mini side cutters	concave	Flush	1.5	0.8	-	-	10	10	120	60
3-654-15	ESD side cutters	-	Semi flush	1.5	1.0	0.4	-	11	13	125	70
3-655-15	ESD side cutters	-	Flush	1.5	1.0	-	-	11	13	125	70
3-656-15	ESD side cutters	-	Semi flush	1.5	1.0	0.3	-	11	13	125	70
3-657-15	ESD side cutters	-	Flush	1.5	1.0	-	-	11	13	125	70
3-658-15	ESD side cutters	-	Full flush	1.5	0.6	-	-	11	13	125	70
3-661-15	ESD mini side cutters	with carbide insert	Semi flush	2.0	1.5	1.0	0.6	11	10	120	70
3-665-15	ESD mini side cutters	with carbide insert	Special flush	only for glass fibre 2.0				11	10	120	65
3-668-15	ESD side cutters	-	Semi flush	2.0	1.5	0.7	-	14	17	135	110
3-669-15	ESD side cutters	-	Flush	2.0	1.5	-	-	14	17	135	110
3-672-15	ESD end cutters	-	Flush	0.8	0.6	-	-	10	5	130	70
3-674-15	ESD top cutters	-	Semi flush	0.8	0.6	-	-	10	5	130	60
3-675-15	ESD oblique top cutters	-	Flush	1.2	1.0	0.4	-	10	10	115	65
▶ HOLDING PLIERS											
									jaw length		
3-681-15	ESD round nose pliers	not serrated jaws	-	-	-	-	-	10	20	130	65
3-682-15	ESD flat nose pliers	not serrated jaws	-	-	-	-	-	10	20	130	70
3-683-15	ESD snipe nose pliers	not serrated jaws	-	-	-	-	-	10	23	130	70
3-685-15	ESD snipe nose pliers	not serrated jaws	-	-	-	-	-	10	32	140	70
3-686-15	ESD snipe nose pliers	serrated jaws	-	-	-	-	-	10	32	140	70
3-687-15	ESD snipe nose pliers	not serrated jaws	-	-	-	-	-	10	19	130	70
3-688-15	ESD flat nose pliers	not serrated jaws	-	-	-	-	-	8.5	18	130	60
3-689-15	ESD snipe nose pliers	not serrated jaws	-	-	-	-	-	12	39	145	70

ESD ELECTRONIC PLIERS TECHNICLENE



The pliers in the TECHNICLENE series are characterised by their exceptional cutting performance. The precisely symmetrical, induction-hardened cutting edges have a hardness of 63-65 HRC and thus achieve particularly high cutting values, making them suitable for hard and special wires (HRC 81 made of tungsten carbide steel is also available on request). The matt-polished surface is scratch proof, glare free and non reflective.

The pliers sit perfectly in the hand thanks to their two-component protective covering, which is ergonomically shaped, dissipative and features an individually adjustable double leaf spring. The smooth screw joint can be readjusted, guaranteeing a long service life if cared for properly. OBSERVE THE CARE INSTRUCTIONS

The pliers have been tested with great results in accordance with DIN EN 61340-5-1, 61340-2-1 and 61340-2-3, as well as for work in ESD protected areas.

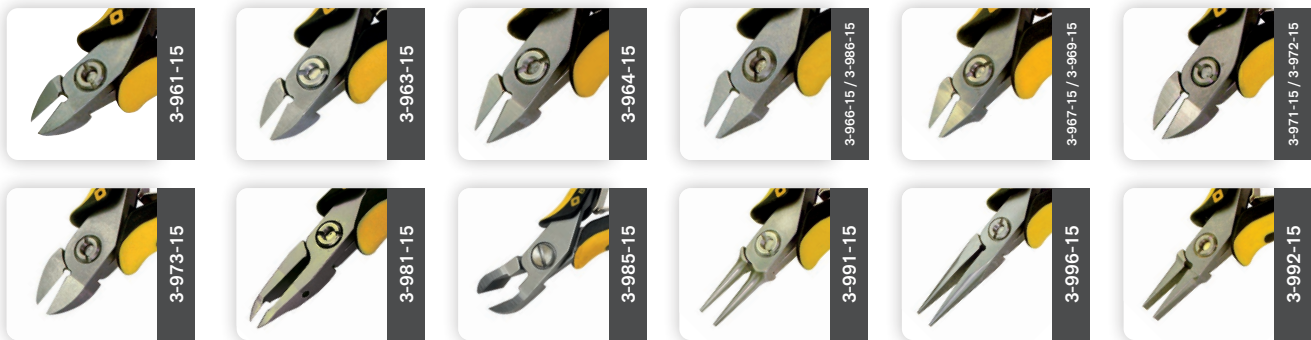
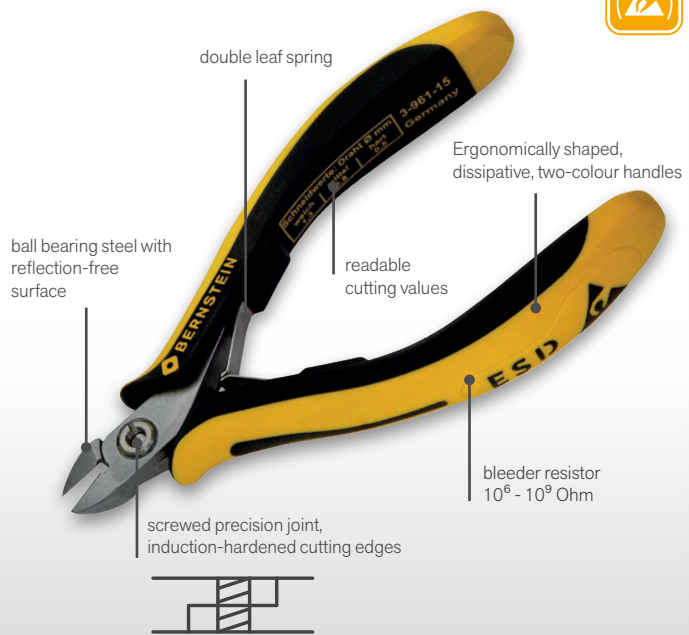

The following types are available, specifications in mm:



Art.-No.	Short description	Type	Flush	Cutting values				Head width	Cutting length	Total length	Weight in g
▶ CUTTING PLIERS											
3-961-15	ESD side cutters	-	Semi flush	1.2	1.0	0.6	-	10	8	120	75
3-963-15	ESD side cutters	-	Full flush	1.0	0.8	-	-	10	8	120	75
3-964-15	ESD side cutters	-	Semi flush	1.2	1.0	0.6	-	10	8	120	75
3-966-15	ESD side cutters	-	Full flush	1.0	0.9	-	-	10	8	120	75
3-967-15	ESD side cutters	-	Semi flush	1.2	1.0	-	-	10	8	120	75
3-969-15	ESD side cutters	-	Full flush	0.8	0.4	-	-	10	8	120	75
3-971-15	ESD side cutters	-	Semi flush	1.6	1.3	0.7	-	12.5	10	125	80
3-973-15	ESD side cutters	-	Full flush	1.6	1.0	-	-	12.5	10	125	80
3-981-15	ESD end cutters	-	Full flush	0.8	0.6	-	-	10	20	135	80
3-985-15	ESD oblique top cutters	-	Flush	1.2	1.0	-	-	10	6.4	130	80
▶ HOLDING PLIERS											
								jaw length			
3-991-15	ESD round nose pliers	not serrated jaws	-	-	-	-	-	10	20	130	75
3-992-15	ESD flat nose pliers	not serrated jaws	-	-	-	-	-	10	20	130	75
3-996-15	ESD snipe nose pliers	not serrated jaws	-	-	-	-	-	10	30	140	80

* All side cutters as tungsten carbide cutters (HRC 81 for hart wires) available on request.

► Wire holder

Wire catchers prevents the wire from falling between assemblies and components on circuit boards or into circuits. These cut wire pieces can cause serious damage. Suitable for side cutters for easy manual retrofitting.

Art.-No.	Side cutters for Art.-No.	For head width in mm	Weight in g
3-999-1	Art.-No. 3-961-15 to 3-696-15	10.0	9
3-999-2	Art.-No. 3-971-15 to 3-973-15	12.5	9



► 3-960-VT

ESD tool kit TECHNICLEINE VARIO 6 pcs

150 x 190 x 80 mm

Weight: 750 g

Art.-No.	Content
5-090-0	ESD tool holder VARIO 8 slots
3-963-15	ESD side cutters TECHNICLEINE full flush 120 mm
3-981-15	ESD end cutters TECHNICLEINE full flush 135 mm
3-992-15	ESD flat nose pliers TECHNICLEINE not serrated jaws 130 mm
3-996-15	ESD snipe nose pliers TECHNICLEINE not serrated jaws 140 mm
5-078-13	ESD SMD universal tweezers 130 mm form PSF stainless steel dissipative
5-055-13	ESD SMD tweezers 120 mm form 7a stainless steel angle 40° dissipative



► 3-970

ESD pliers set TECHNICLEINE 4 pcs

190 x 135 x 35 mm

Weight: 545 g

Art.-No.	Content
3-680-0	ESD dissipative bag 4 empty compartments
3-963-15	ESD side cutters TECHNICLEINE full flush 120 mm
3-971-15	ESD side cutters TECHNICLEINE semi flush 125 mm
3-992-15	ESD flat nose pliers TECHNICLEINE not serrated jaws 130 mm
3-996-15	ESD snipe nose pliers TECHNICLEINE not serrated jaws 140 mm



► 3-970-T

ESD pliers set TECHNICLEINE 4 pcs

320 x 150 x 20 mm

Weight: 410 g

Also available as ESD dissipative zipper pocket (Art.-No. 3-970)

Art.-No.	Content
3-960-0	ESD dissipative bag 4 empty compartments
3-963-15	ESD side cutters TECHNICLEINE full flush 120 mm
3-971-15	ESD side cutters TECHNICLEINE semi flush 125 mm
3-992-15	ESD flat nose pliers TECHNICLEINE not serrated jaws 130 mm
3-996-15	ESD snipe nose pliers TECHNICLEINE not serrated jaws 140 mm



ROBUST PLIERS



Material Q & T steel according to DIN
Cutting edges inductively hardened
The following types are available, specifications in mm:

Art.-No.	Short description	Type	Flush	Cutting values				Head width	Cutting/ jaw length	Total length mm	Weight in g
				○	◊	●	Ⓟ				
3-235-16	Telephone pliers	serrated jaws	-	-	-	-	-	15	55	160	145
3-245-16	Telephone pliers	serrated jaws	-	-	-	-	-	18	75	205	210
3-255-16	Telephone pliers	serrated jaws	-	-	-	-	-	18	70	205	210
3-531-16	Flat nose pliers	serrated jaws	-	-	-	-	-	15	40	150	105
3-132-16	Side cutters	-	Full flush	4.0	2.3	1.5	-	15	16	130	125
3-133-16	Side cutters	-	-	4.0	2.5	1.8	-	18	18	150	155
3-732-16	Combination pliers	serrated jaws	-	4.0	2.5	2.0	-	23	35	170	205



The pliers of this program have been successfully tested by several testing laboratories according to DIN EN 61340-5-1, 61340-2-1, as well as 61340-2-3 for work in ESD-protected areas.

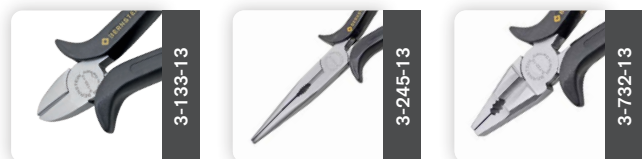

The following types are available, specifications in mm:

Art.-No.	Short description	Type	Flush	Cutting values				Head width	Cutting/ jaw length	Total length mm	Weight in g
				○	◊	●	Ⓟ				
3-133-13	ESD side cutters	-	Semi flush	4.0	2.5	1.8	-	18	18	145	165
3-245-13	ESD telephone pliers	serrated jaws	Semi flush	-	-	-	-	18	75	200	180
3-732-13	ESD combination pliers	serrated jaws	Semi flush	4.0	2.5	1.8	-	23	35	165	185

PLIERS WITH SPECIAL REQUIREMENTS

▶ 3-573

Water pump pliers 180mm with push-button

Size adjustable at the push of a button - thanks to the push button.
With extra slim head for hard-to-reach places and protective, non-slip handles.

Total length: 180 mm, weight: 170 g



▶ 3-575-6

Water pump pliers 240 mm

Water pump pliers 240 mm, very stable, dip insulated, non-slip handles.

Total length: 240 mm, weight: 380 g



▶ 3-0648

Cable cutter up to Ø 10.5 mm with lock function

especially for coaxial cables, robust design, spring and locking device, not for steel wire

Total length: 170 mm, weight: 155 g



▶ 3-0641

Mini side cutters full flush for CU-wire up to Ø 1.0 mm

Elektronik Seitenschneider mit Feder, ohne Schneidwate, für CU-Drähte bis Ø 1,0 mm / 18 AWG.

Gesamtlänge: 135 mm, Gewicht: 70 g



3-0641

▶ 3-0641-ESD

Mini side cutters full flush for CU-wire up to Ø 1.0 mm

Elektronik Seitenschneider mit Feder, ohne Schneidwate, für CU-Drähte bis Ø 1,0 mm / 18 AWG.

Gesamtlänge: 135 mm, Gewicht: 70 g



3-0641-ESD

▶ 3-0645

Stripping side cutters full flush for CU-Wire up to Ø 0.8 mm

Stripping side cutter standard version, with spring, without cutting edge, for CU wires up to Ø 0.8 mm / 22-26 AWG.

Total length: 130 mm, weight: 80 g



3-0645

▶ 3-0645-ESD

Stripping side cutters full flush for CU-Wire up to Ø 0.8 mm

Stripping side cutter standard version, with spring, without cutting edge, for CU wires up to Ø 0.8 mm / 22-26 AWG.

Total length: 135 mm, weight: 70 g



3-0645-ESD



STRIPPING AND CRIMPING TOOLS - ALL ABOUT CABLES

Our multifunctional wire strippers are designed with factors of efficiency in mind, as time is money. Cable stripping, round cuts, long cuts, skinning, everything is possible with just one tool and often including an adjustable length stop.

We also offer wire strippers in different models for all common flexible and solid conductors. In addition, we sell all types of cable stripping knives and clippers (see the chapter „Cutting and measuring“) for the reliable, precise and fast stripping of wires.

The pinch-free cut is necessary for effortless crimping in order to assemble conductors with sleeves and connectors. Here, BERNSTEIN offers a comprehensive range of crimping tools to meet various requirements.

ESD STRIPPING TOOLS

► 5-542 ESD precision stripper Ø 0,25 - 0,80 mm (AWG 20 - 30)

Precision Stripper ESD Plus for applications for applications in fields where electrostatic discharge could damage components. Particularly suitable for conductors with external insulation made of PVC, Teflon, KYNAR, TEFLON, MYLAR. With dissipative plastic body.

Total length: 102 mm, Weight: 28 g



5-542

stripping tools

► 5-532

Stripping and crimping tools 0,5 - 6 mm² with stop

Stripping and crimping tool for professional stripping, crimping and cutting with only one tool, automatic adjustment to the conductor cross-section, stranded conductors can be twisted afterwards, simple stripping of 0.5 - 6.0 mm². Blades made of special stainless steel, plastic body stripping length 5 mm, crimping ranges for terminals: 0.5 - 2.5 und 4.0 - 6.0 mm², cutting capacity of the side cutters max. 6.0 mm², conductors max. 4.0 mm².

Total length: 160 mm, Weight: 114 g

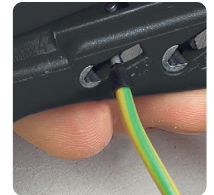

5-532

► 5-533

Stripping tools for data lines

Data-Strip stripping tool for stripping data cables, telephone lines, control cables and special cables. data cord: Ø 4 - 10 mm control lines: Ø 0,2 - 0,8 mm, adjustable inner knife 0,2 - 1,4 mm, side cutters, plastic body

Total length: 125 mm, Weight: 62 g



5-533

► 5-0605

Stripping tool with adjustable knives

Universal stripping tools Handy synthetic design with adjustable knives, easy handling. Blades made of special stainless steel, non-slip

Total length: 100 mm, Weight: 38 g

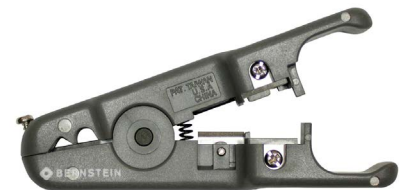

5-0605

► 5-535

Coax cable stripperr Ø 4,8 - 7,5 mm

Coaxial strippers for gradual stripping of all common coaxial cables (for example antennas and transmission cables) and flexible cables Coaxial cables of Ø 4.8 - 7.5 mm. NYM 3 x 0.75 mm², for flexible cables 10 mm² and 16 mm². blades made of special stainless steel, plastic body

Total length: 110 mm, Weight: 27 g



5-535

► 5-534

Data cable stripper Ø 4,5 - 10 mm

Date cable stripper with ergonomically shaped handles, no adjustment of the cutting depth required, also for hard-to-reach places, e.g. in ceiling and wall areas, in junction and distribution boxes, switch cabinets, etc. Suitable for u.a. Cat5, Cat6, Cat7, twisted pair cable, Ø 4.5 - 10 mm.

Total length: 125 mm, Weight: 41 g



5-534

► **5-536**
Round cable stripper Ø 8 - 13 mm

Round cable stripper with ergonomically shaped handles, no adjustment of the cutting depth required, also for hard-to-reach places, e.g. in ceiling and wall areas, in junction and distribution boxes, switch cabinets, etc. Blades made of special stainless steel

For all common round and wet room cables 45 from Ø 8 - 13 mm, eg. NYM 3 x 1.5 mm² to 5 x 2.5 mm². Plastic body

Total length: 125 mm, Weight: 41 g



5-536

► **5-531**
Automatic wire stripper 0.2 - 6 mm² mit Anschlag

Automatic stripping pliers for all common flexible and solid conductors from 0.2 - 6.0 mm², adjustable length stop from 5 - 12 mm, if required with removable integrated side cutters up to max. Ø 2 mm. Blades made of special stainless steel, plastic body, non-slip

Total length: 190 mm, Weight: 106 g

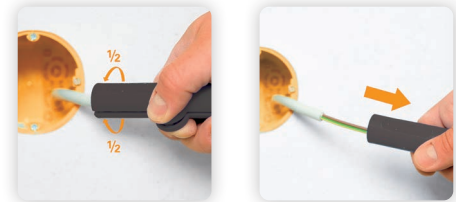

Application example 5-535, 5-534, 5-536

► **5-531-10**
Replacement knives for Art.-No. 5-531 (pair)

Blades made of special stainless steel
 Weight: 20 g



5-531

5-531-10

► **3-0856**
Crimping pliers/wire stripper

Cable lug pliers for insulated and non-insulated cable lugs. Tool steel (HRC 54 - 56), surface burnished, insulated handle, non-slip.

Total length: 230 mm, Weight: 300 g

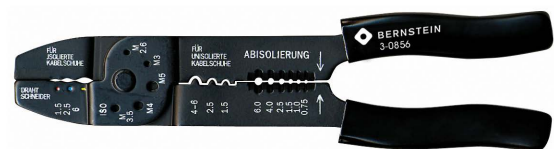

3-0856

► **3-815-16**
Wire stripper with adjusting screw and opening spring

Inserted joint stripping pliers with adjusting screw for all wire thicknesses, with compression spring, high-quality steel (HRC 54 - 56), 2-component plastic ergonomically formed, non-slip

Total length: 160 mm, Weight: 120 g



5-815-16

► **5-181**
Wire scraper tweezers 125mm

For removal of varnish insulation on copper wires.
 Weight: 33 g

► **5-182**
Replacement knives for Art.-No. 5-181 (pair)

Blades made of high-quality steel
 length 20 mm, Weight 2 g



5-182

5-181

STRIPPING KNIVES

► 5-501 Cable knife (open 200 mm)

Cable knife with steel blade, wooden shells and wire scraper.
Total length: 200 mm, Weight: 78 g



5-501

► 5-503 Cable knife Ø 8 - 22 mm

For precise, fast and safe stripping of all common round cables from Ø 8 - 28 mm, cutting depth adjustment by adjusting screw at the handle end, the rotating inner blade automatically switches from round to longitudinal cutting.

Total length: 140 mm, Weight: 68 g



5-503

► 5-504 Cable knife Ø 4 - 16 mm

For precise, fast and safe stripping of all common round cables from Ø 4 - 16 mm, cutting depth adjustment by adjusting screw at the handle end, the rotating inner blade automatically switches from round to longitudinal cutting.

Total length: 140 mm, Weight: 66 g



5-504

► 5-505 Stripping knife Ø 4 - 28 mm with hookblade

For precise, fast and safe stripping of all common round cables from Ø 4 - 28 mm, cutting depth adjustment by adjusting screw at the handle end, the rotating inner blade automatically switches from round to longitudinal cutting.

Total length: 185 mm, Weight: 78 g



5-505

► 5-506 Stripping knife Ø 4 - 28 mm with straight blade

For precise, fast and safe stripping of all common round cables from Ø 4 - 28 mm, cutting depth adjustment by adjusting screw at the handle end, the rotating inner blade automatically switches from round to longitudinal cutting.

Total length: 180 mm, Weight: 82 g



5-506

Application pictures:
apply to
5-503, 5-504, 5-505, 5-506



turning out the knife



longitudinal section

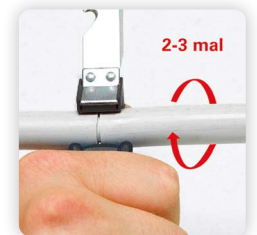

cross section

INSERTION TOOL

▶ 2-701 LSA-Plus insertion tool

KRONE LSA-Plus termination tool for non-soldering, non-screwing and non-stripping connection of the wires and at the same time cutting off the remaining lengths, on strips or boxes. For laying data cables on data outlets or patch panels. Application tool for all data, information and telecommunication cabling, applicable for all LSA-PLUS® series as well as RJ45 sockets and high-band, for connecting conductor diameters (0.35-0.9mm) and core diameters (0.7-2.6mm).

Total length: 185 mm, Weight: 62 g



2-701

CRIMPING TOOLS

▶ 3-0601 Crimping pliers for connector types HT-2094C

Pliers made of solid metal, with interchangeable blades, spring and closed lock, for cutting, cable stripping and crimping of the most common connector types. Tool steel (HRC 54 - 56), blades made of special stainless steel, plastic handle

Total length: 200 mm, Weight: 320 g



3-0601

▶ 3-0601-00 Replacement knives 3-0601 (PU 6)

Blades made of special stainless steel
Weight: 260 g



3-0601-00

▶ 3-0605 Combination modular crimping pliers

Solid metal pliers with interchangeable blades, spring and closed locking mechanism, for cutting, stripping and crimping the most common connector types. 6P/6C - 6P/4C - 6P/2C - 8P/8C tool steel (HRC 54 - 56), special stainless steel blades, plastic handle

Total length: 200 mm, Weight: 320 g

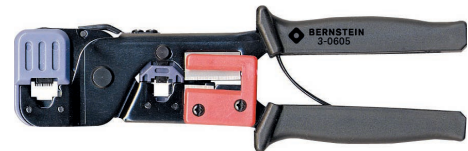

3-0605

▶ 3-0605-00 Replacement knives 3-0605 (pair)

Blades made of special stainless steel
Weight: 260 g



3-0605-00

▶ 3-0609 Universal crimping pliers

Universal crimping pliers, patented design robust metal pliers, for cutting, stripping and crimping, exchangeable knives, spring and locking device, ratchet mechanism. For 4P4C - 4P2C - 6P6C/RJ - 12 - 6P4C/RJ - 11 - 8P8C/RJ45 - DEC 6P6C, Tool steel (HRC 54 - 56), Klingen aus rostfreiem Spezialstahl

Total length: 200 mm, Weight: 520 g



3-0609

▶ 3-0609-00 Replacement knives 3-0609 (pair)

Blades made of special stainless steel
Weight: 260 g



3-0609-00

▶ **3-0611****Crimping pliers for BNC and TNC coaxial connectors**

For BNC and TNC coaxial connectors, with ratchet lock and automatic release, suitable for internal contacts and external receptacles. Tool steel (HRC 54 - 56), surface burnished, Pressing range: hexagon socket for all inner contacts. Crimp length 2.3 mm inner-Ø (0.068 inch) 1.73 mm. Small hex for RG 58 crimp length 10.0 mm inner-Ø (0.213 inch) 5.41 mm. Middle hex for RG 59/62 crimp length 10.0 mm inner-Ø (0.256 inch) 6.50 mm. Large hex for RG 6 crimp length 10.0 mm inner-Ø (0.319 inch) 8.10 mm.

Total length: 200 mm, Weight: 520 g



3-0611

▶ **3-0611-00****Ersatzmesser für 3-0611 (Paar)**

Blades made of special stainless steel
Weight: 260 g



3-06011-00

▶ **3-0612****Automatic crimping pliers**

Automatic crimping pliers ratchet mechanism for crimping insulated terminals. version: 0.5 - 1.0 / 1.5 - 2.5 / 4 - 6 mm² (AWG 22 - 18 / 16 - 14 / 12 - 10) tool steel (HRC 54 - 56), surface burnished

Total length: 200 mm, Weight: 520 g



3-0612

▶ **3-871-6****Pressing pliers 155 mm for wire 0.25 - 2.5 mm²**

Crimping pliers, for wire end ferrules combined with wire cutters and stripping frames, for various wire thicknesses, for wire end ferrules from 0.25 - 2.5 mm² carbon steel. surface matt chrome plated, high-quality steel (HRC 54 - 56), handle dipped insulation, non-slip

Total length: 155 mm, Weight: 165 g



3-871-6

▶ **3-875-6****Pressing pliers 255 mm for wire 0.5 - 16.0 mm²**

Crimping pliers, for wire end ferrules combined with wire cutters and stripping frames, for various wire thicknesses, for wire end ferrules from 0.50 - 16.0 mm² carbon steel. surface matt chrome plated, high-quality steel (HRC 54 - 56), handle dipped insulation, non-slip

Total length: 226 mm, Weight: 285 g



3-875-6

TERMS OF SALE AND DELIVERY

GENERAL

The nature and scope of delivery are specified in the order confirmation. The following delivery terms shall apply to all deliveries to be carried out by us. Purchasing conditions of the customer do not oblige us, even if we do not expressly contradict this. Verbal or by intercom agreements made require our written confirmation. Obvious mistakes in offers, order confirmations, etc. are expressly reserved and can be considered at any time. We are entitled to process any data relating to the business relationship or in connection with the same concerning buyers, whether the buyer itself or third parties, within the framework of the Federal Data Protection Act.

OFFER

Our offers are permissive, an order is deemed to be granted if confirmed by us in writing. PRICES, DELIVERY BASIS AND PACKAGING Unless otherwise agreed, the prices in Euros, ex works, are exclusive packaging. In the case of special packaging regulations of the customer, the additional costs involved are invoiced. Packaging is not accepted.

DELIVERY

The delivery takes place at the expense and risk of the buyer without regard to who bears the freight costs. We reserve the right to place orders in partial deliveries. For custom-made products, excess or short deliveries of up to 10% are permitted.

DELIVERY TIME

The delivery time begins upon receipt of all information required for the execution of the order. We endeavor to comply with the delivery time specified in the order confirmation. No claims of any kind can be asserted from a delayed delivery.

COMPLAINTS

Complaints can only be accepted within 8 days after receiving of the goods.

The shape and colour of the tool may differ from the item shown in the catalogue.

GUARANTEE

For all BERNSTEIN tools, which are unusable due to proven material or manufacturing defects, we deliver within one year after deliver a replacement. This free replacement service is excluded if the tools have become unusable due to natural wear or improper handling.

DISCLAIMER

We do not assume any guarantee for the suitability of our products for the intended purpose of the customer. For damages caused by unsuitable or improper use, commissioning by the customer or third parties, and for the natural wear and tear we assume no guarantee. Any claims for damages, irrespective of the legal basis, as well as, in particular, the liability by tort (product liability) are excluded to the extent permitted by law.

PAYMENT

Our invoices are payable within 10 days of the invoice date with 2% discount or in 30 days net, unless otherwise agreed in the order confirmation.

RESERVATION OF TITLE

We reserve the title to all goods delivered by us until the buyer has paid all claims arising from the business relationship. The buyer is entitled to resell the reserved goods in ordinary business transactions. In the case of resale, the buyer has to reserve the ownership of the sold goods on the same terms as his customer. The purchaser hereby assigns to us the purchase price claim against the buyer from the resale.

FULFILLMENT AND JURISDICTION

Place of performance and jurisdiction for delivery and payment is Remscheid. In any case, only German law shall apply, with the exclusion of any foreign law.

ONLINE DISPUTE RESOLUTION

The European Commission provides a platform for online dispute resolutions (ODR) which can be accessed at

<https://ec.europa.eu/consumers/odr/>.

In order to settle dispute arising from a contractual relationship with a consumer or from whether such a contractual relationship exists at all, we will participate in dispute settlement proceedings before a consumer dispute resolution body. Consumers can contact their national European Consumer Centre in this regard. The respective contact details of the individual ECCs can be found at

<https://www.evz.de/en/alternative-dispute-resolution/adr-in-europe/>.

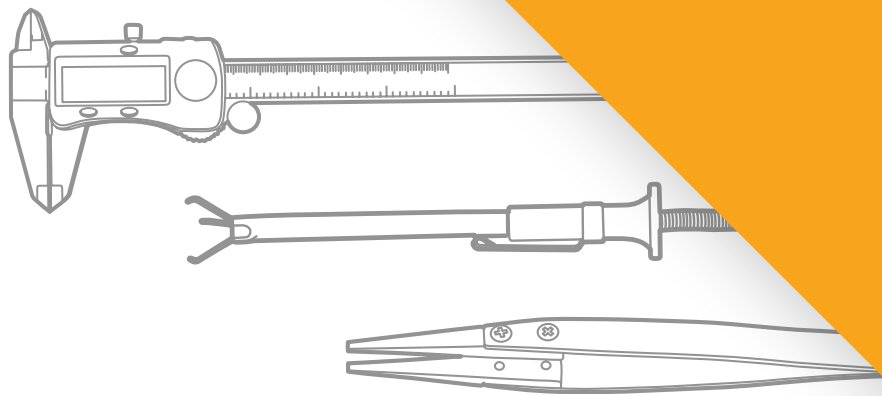



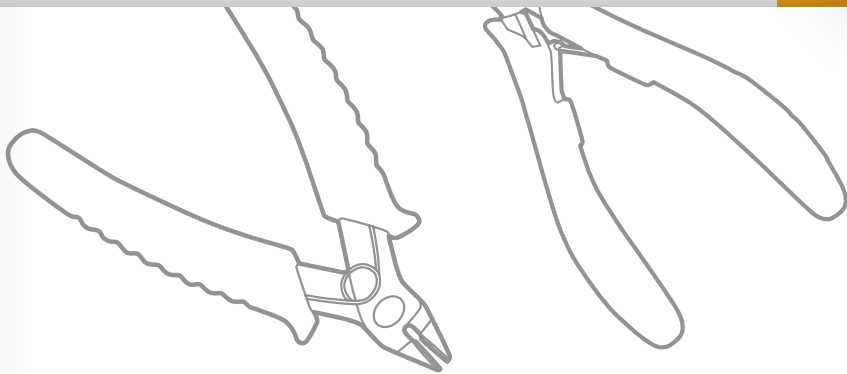

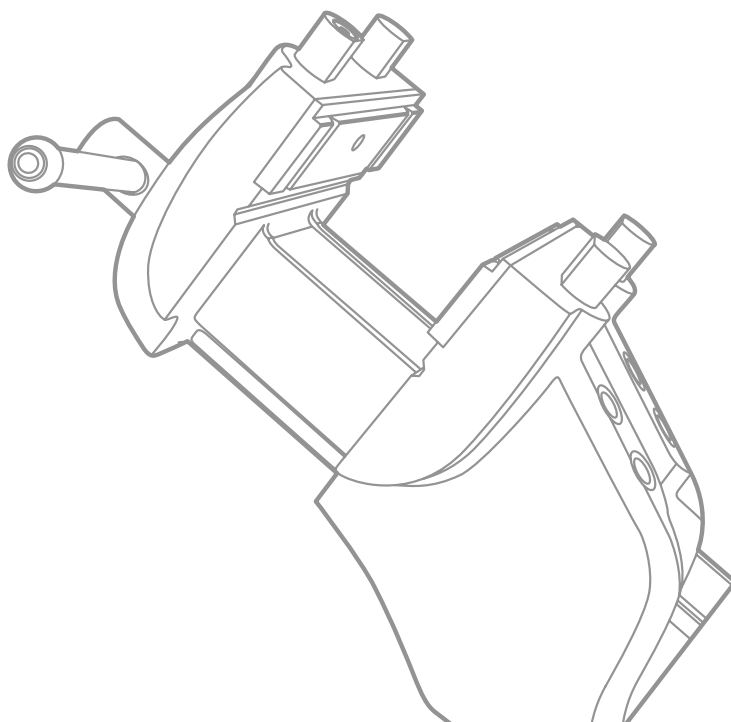



A little story about the word amber (BERNSTEIN)

The greek word for amber is „elektron“: the root of today's term electronics. Even the greeks discovered the special feature of amber: by rubbing the natural amber can be electrostatically charged. The charged stone can attract dust particles. Today you can use this property to check the authenticity of an amber. If it is real, it can be tested through charge rubbing on a cotton cloth.

You can also wear it as jewellery: it should protect from evil magic and give joy of life.

Just like our high-quality BERNSTEIN ESD Tools - them protect against electrostatics and give joy with the daily work.

– Max Walter Hartmut Blombach, 2020

BERNSTEIN

Werkzeugfabrik Steinrücke GmbH

Industriehof Trecknase 1
42897 Remscheid

Tel. + 49 (0) 2191 - 9650 - 0
Fax + 49 (0) 2191 - 9650 - 30

sales@bernstein-tools.de
www.bernstein-tools.de

X-ON Electronics

Largest Supplier of Electrical and Electronic Components

Click to view similar products for [Pliers & Tweezers](#) category:

Click to view products by [Bernstein](#) manufacturer:

Other Similar products are found below :

[0026](#) [T0058765801](#) [80](#) [76C](#) [378MN](#) [L4VN](#) [LN54VN](#) [NN7776VN](#) [54CGVN](#) [SN55VN](#) [DRP10N](#) [0036](#) [PN 5050/21D](#) [505BGC](#) [622TX](#)
[43450](#) [8150 CO](#) [8165 CO](#) [32BSA25](#) [5BSAF](#) [017610101](#) [PN 5025](#) [65516300](#) [YT-2469](#) [011640100](#) [010480315](#) [503 618 3](#) [PGT435](#) [T3653](#)
[250](#) [5000522](#) [011770113](#) [011770101](#) [CPE.A4](#) [T3781](#) [189A.17VE](#) [PPR 5003 D](#) [131 010 2](#) [40603GP](#) [011780102](#) [45705](#) [CPES](#) [6151](#)
[181A.18CPE](#) [391A.16VE](#) [181EF.25CPEPB](#) [011640096](#) [CPE.A1PB](#) [SS406-160](#) [192A.18VE](#) [8000 0001 0 0](#)