



BERNSTEIN
TOOLS FOR ELECTRONICS



SCREWING TOOLS TORQUE + BITS

Vers.01

GET IN CONTACT WITH US**BERNSTEIN****Werkzeugfabrik
Steinrücke GmbH**

Industriehof Trecknase 1
42897 Remscheid

Tel. + 49 (0) 2191 - 9650 - 0
Fax + 49 (0) 2191 - 9650 - 30

sales@bernstein-tools.de

VISIT US ON THE WEB

We update our product information on a regular basis and automatically using our Product Information System. This enables the quick and up-to-date compilation of customer-specific data feeds for your own digital sale activities. Take advantage of this service and always keep Bernstein product information up to date!

www.bernstein-tools.de

Product videos and blog posts round off our online offering. Furthermore, we also respect the traditional sales channel via specialist retailers and offer the option to present your webshop as an online sales platform for products by BERNSTEIN.

SYMBOL LEGEND**NEU**

New product



Number of tools in sets



Weight



Dimensions



ESD protection (EPA suitable)



VDE tested



FOR EVERY SCREW THE RIGHT BLADE



Demands on bolted connections are increasing, and this also applies increasingly to connections with low pretensioning forces, because bolts always tend to be tightened too tightly. This can lead to major damage. That is why it makes sense to tighten screws with a firmly defined torque.

For quality assurance in production assembly and in the repair of electronic components, tools must be used where the tightening torques can be limited. That is why we have developed a torque screwdriver and a series of **preset torque adapters** for easy handling in the electronics sector.

With the right tool and the correct torque specifications, you will produce a screw connection that will serve its purpose permanently and save you a costly thread repair.

In addition to conventional screwdriving tools, we also offer **ESD screwdriver solutions** for all common screw heads. Especially for electrotechnical applications, such as working on protected devices, sensitive circuits and connections.

All **ESD screwdrivers are EPA suitable** and are used as a safe method of dissipating electrostatic charge when working in protected areas (ESD workplace/ESD protection zone).

PRESET TORQUE-ADAPTER ONE SYSTEM MANY POSSIBILITIES

TORQUEline from BERNSTEIN impressed with its flexibility. We developed a tool system that allows to combine the single components in various ways. Thus, you always have the right torque for every application.

Adapters turn any bit holder into a professional torque screwdriver

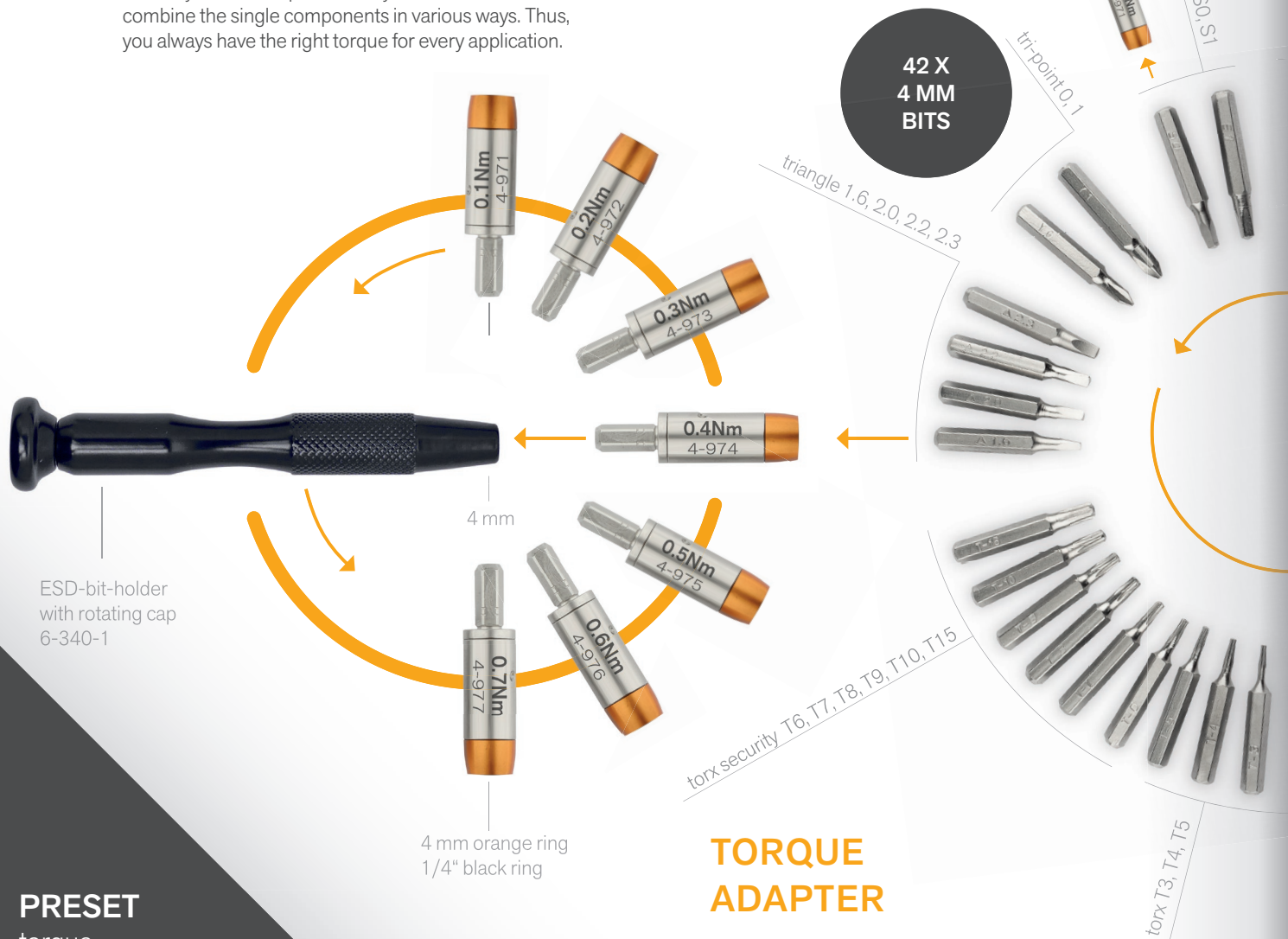

ESD-bit-holder with rotating cap 6-340-1

4 mm

4 mm orange ring
1/4" black ring

PRESET

torque
0.1 Nm - 0.7 Nm (4 mm)
0.6 Nm - 5.5 Nm (1/4")



TORQUE ADAPTER

Turn your bits and a holder into your perfect torque tool. Can be conveniently combined with a preset torque for tightening or loosening. These precise fine tools are available from 0.1 to 5.5 Nm. Often as a complete solution for working on electronic devices, in quick-change systems, robot stations, aerospace, medical technology or simply on every workbench, wherever the exact torque is required.

The click sound indicates when torque is reached, so the adapter cannot be overtorqued. No torque is released when loosening screws (due to the locked core shaft), so no additional loosening tool is required.

- ▶ 20.000 CLICKS
- ▶ ±10 % NM-TOLERANCE
- ▶ MAX 100 RPM

TORQUE SCREWDRIVER

The torque-screwdriver was developed to carry out the screwdriving process precisely and reproducibly with the right tightening torque. With the screwdriver you can choose and adjust the torque (0.05 to 0.6 Nm).

It has a hexagon 1/4 inch bit holder with a clamping ball. The torque can be adjusted and locked via a knurled screw to the desired size.

Useful accessories for the bit adapter from hex 1/4" to hex 4 mm bits or an extension (115 mm)

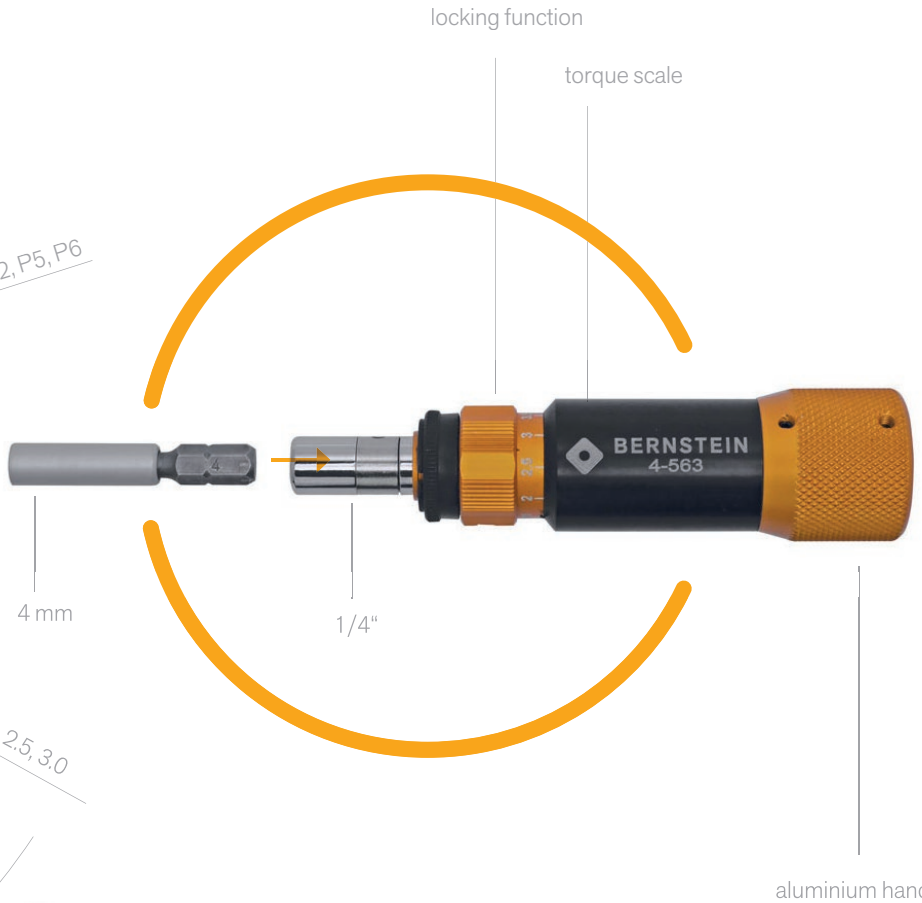

ADJUSTABLE
torque
0.05 Nm - 0.6 Nm
(5 - 60 cNm)



TORQUE-SETS

► 4-970-G (with handle)

Adapter set 0.1 - 0.6 Nm

6 torque adapters 0.1 - 0.2 - 0.3 - 0.4 - 0.5 - 0.6 Nm for 4 mm bits (outer Ø 8 mm)
 + 1 bit adapter 1/4 inch to 4 mm, steel-aluminium, length 42.5 mm
 + 1 bit adapter 1/4 inch to 4 mm, chrome-plated steel, length 25 mm
 packed in a Quadro box (91 x 43 x 15 mm)
 + Screwdriver handle 4 mm with magnetic holder for 4 mm bits (blade outer Ø 7.5 mm)

Art.-Nr. Set	4-970-G	4-970-KSB
handle 4-106	✓	-
weight	108 g	70 g



4-970-G

► 4-980-G (with handle)

Adapter set 0.6 - 3.0 Nm

6 torque adapters 0.6 - 0.9 - 1.2 - 1.4 - 2.0 - 3.0 Nm for 1/4" bits (outer Ø 12 mm)
 packed in a Quadro-Box (91 x 43 x 15 mm)
 + screwdriver handle 1/4" with magnetic holder for 1/4" bits (blade outer-Ø 10 mm)

Art.-Nr. Set	4-980-G	4-980-KSB
handle 4-107	✓	-
weight	198 g	141 g



4-980-G

► 4-989-G (with handle)

Adapter set 3.0 - 5.5 Nm

6 torque adapters 3.0 - 3.5 - 4.0 - 4.5 - 5.0 - 5.5 Nm for 1/4" bits (outer Ø 12 mm)
 packed in a Quadro-Box (91 x 43 x 15 mm)
 + screwdriver handle 1/4" with magnetic holder for 1/4" bits (blade outer-Ø 10 mm)

Art.-Nr. Set	4-989-G	4-989-KSB
handle 4-107	✓	-
weight	198 g	141 g



4-989-G

► 4-116

ESD Screwdriver-handle dissipative 10^5 bis 10^7 Ohm
 5/32 inch (4 mm) bit magnetic holder
 holder outer-Ø 7.5 mm
 Length 95 mm, weight 31 g



► 4-117

ESD Screwdriver-handle dissipative 10^5 bis 10^7 Ohm
 1/4 inch (6.35 mm) bit magnetic holder
 holder outer-Ø 8.0 mm
 Length 105 mm, weight 58 g



TORQUE SCREWDRIVER

► 4-563

torque screwdriver
0.05 - 0.6 Nm with adapter

Aluminum handle with knurling, socket hex 1/4 inch (6,35 mm)
Tolerance: ± 6 %, total length 100 mm, weight 111 g

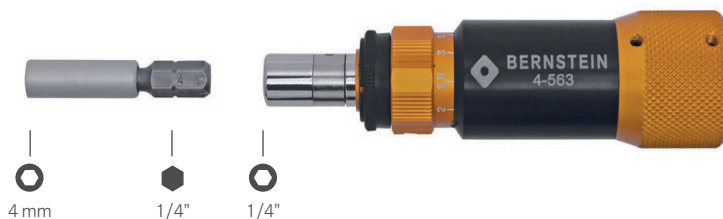

The torque from 0.05 to 0.6 Nm can be set to the required size using a knurled screw, the set value can then be locked. When the set torque is reached there should be an audible click and a click should be felt. If this is not the case, please readjust the small screw so that the screwdriver clicks audibly. When not in use, return the torque-screwdriver back in starting position (0 Nm). This relieves the preload and prevents premature wear.

The torque screwdriver is a precision instrument. To ensure warranty, calibration must be performed regularly and is the responsibility of the owner. The recommended calibration interval is every 12 months and may be shorter depending on the application. The product is lubricated by the manufacturer for lifelong use and should not be additionally oiled. Ideally, always put it back in the box after using to keep dirt and moisture away. Never disassemble the torque screwdriver yourself. If you need to repair the torque screwdriver, please contact a qualified service station. An improper repair attempt can lead to damage to this instrument and then it no longer meets the requirements of DIN ISO 6789 and ASME 8107.300-2010.

PRESET TORQUE ADAPTER

► Torque Adapter for 4 mm bits (5/32")

hex socket, hex drive, tolerance ±10 %
adapter Ø 8 mm, material stainless steel
total length 32 mm, weight 7,5 g

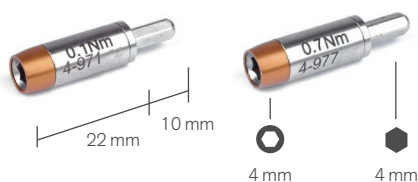

Art.-No.	NM	KgfcM	in-lb	hex
4-971	0.1	1.0	0.9	4 mm
4-972	0.2	2.0	1.8	4 mm
4-973	0.3	3.1	2.7	4 mm
4-974	0.4	4.1	3.5	4 mm
4-975	0.5	5.1	4.4	4 mm
4-976	0.6	6.1	5.3	4 mm
4-977	0.7	7.1	6.2	4 mm

The clicking sound indicates when the torque has been reached so that the adapter cannot be over-tightened. When loosening screws there is no turning moment unlocking takes place, so no additional release tool is required.

Adapters are primarily suitable for manual operation. In connection with a power tool, we recommend a maximum speed of 100 rpm, with a minimum click Repetition. Higher speed possible as a custom-made product, please contact us!

► Torque Adapter for 1/4 inch bits (6.35 mm)

hex socket, hex drive, tolerance ±10 %
adapter Ø 12 mm, material stainless steel
total length 38,3 mm, weight 21 g

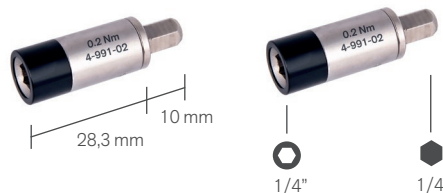

Art.-No.	NM	KgfcM	in-lb	hex	
4-991-02	0.2	2.0	1.8	1/4"	NEW
4-991-03	0.3	3.1	2.7	1/4"	NEW
4-991-04	0.4	4.1	3.5	1/4"	NEW
4-991-05	0.5	5.1	4.4	1/4"	NEW
4-981	0.6	6.1	5.3	1/4"	
4-982	0.9	9.2	8.0	1/4"	
4-983	1.2	12.0	10.6	1/4"	
4-984	1.4	14.0	12.4	1/4"	
4-985	2.0	20.0	17.7	1/4"	
4-985-5	2.5	25.5	22.1	1/4"	
4-986	3.0	30.6	26.6	1/4"	
4-986-5	3.5	35.7	31.0	1/4"	
4-987	4.0	40.8	35.4	1/4"	NEW
4-987-5	4.5	45.9	39.8	1/4"	NEW
4-988	5.0	51.0	44.3	1/4"	NEW
4-988-5	5.5	56.1	48.7	1/4"	NEW

TORQUE SCREWDRIVERS AND SETS

► 4-930

Bit set with Torque Screwdriver 0.05-0.6 NM 46 PCS

- Torque Screwdriver 5-60cNm (0.05-0.6Nm) hex Drive 1/4 inch
 - + Bit set 42 pcs, 4mm hex bits (5/32 inch)
 - + ESD bit holder dissipative for 4mm hex bits (5/32 inch)
 - + Bit extension for 4mm hex bits (5/32 inch)
 - + Bit Adapter 1/4 inch to 4mm bits, length 42.5mm
- weight: 420 g



► Bit-set with Adapter 51 or 47 pcs

weight: 427 g / 410 g

Art.-Nr.	Content
4-970	6 torque 0.1 - 0.2 - 0.3 - 0.4 - 0.5 - 0.6 Nm for 4 mm bits + Bit-adapter 1/4 inch (6.35 mm) > 4 mm (5/32") + Bit-set 44 pcs
4-970-A	2 torque 0.1 + 0.2 Nm for 4 mm bits + Bit-adapter 1/4 inch (6.35 mm) > 4 mm (5/32") + Bit-set 44 pcs
4-970-B	2 torque 0.3 + 0.4 Nm for 4 mm bits + Bit-adapter 1/4 inch (6.35 mm) > 4 mm (5/32") + Bit-set 44 pcs
4-970-C	2 torque 0.5 + 0.6 Nm for 4 mm bits + Bit-adapter 1/4 inch (6.35 mm) > 4 mm (5/32") + Bit-set 44 pcs

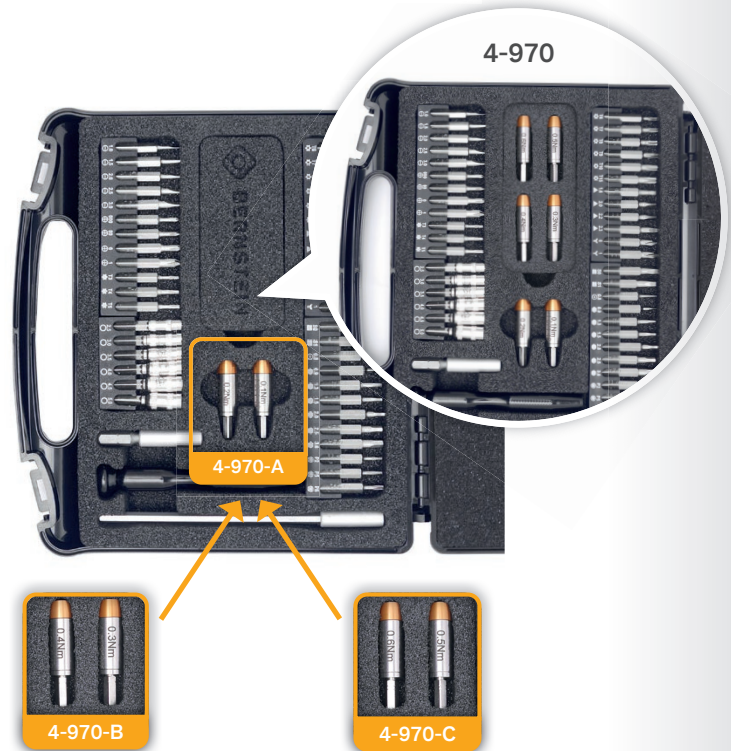

Bit adapter 1/4 inch (6.35 mm) > 4 mm (5.32 inch)

► 4-564 plug-in shank

Material steel/aluminium, blade length 28 mm, blades-Ø 8 mm
Total length 42.5 mm, weight 11 g

► 4-566 plug-in shank

Material steel chrome plated, blade length 13 mm, blades-Ø 8mm
Total length 25 mm, weight 6 g

Extensions for C4 (4mm) bits

► 4-567 Bit extension 60 mm

Blade length 35 mm, shank length 25 mm (shank outer-Ø 8mm)
Socket and drive hex 4 mm
Material steel/aluminium eloxed, weight 7.5 g

► 6-340-2 Bit extensions 115 mm

Blade length 90 mm, shank length 25 mm (shank outer-Ø 8mm)
Socket and drive hex 4 mm
Material steel/aluminium sandblasted, weight 13 g

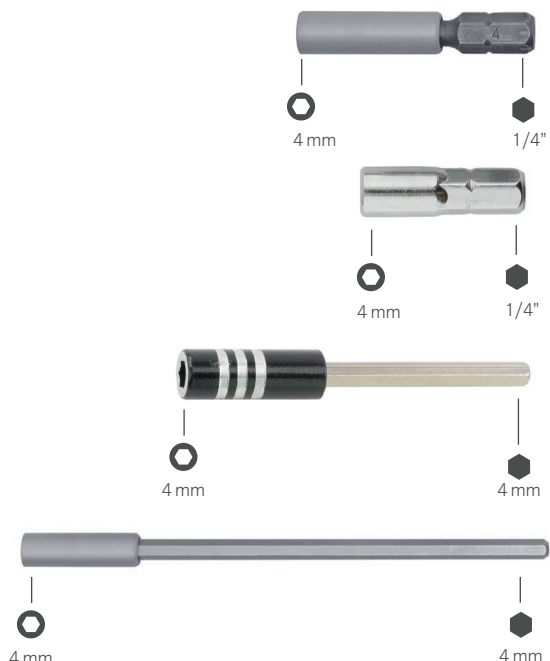











BITS AND BIT SETS

► 6-340-3

4 mm Bit Set 42 pcs (without box)

3 bit bars with 36 special bits
 1 bit bar with 6 nut setters
 Quality steel sandblasted nickel-plated 52-54 HRC
 C4 Bits fillgree tool for fine work
 hex, blade length 22 mm, blades Ø 8 mm
 Dimensions bit bars. 65 x 8 x 28 mm, weight: 117 g

Bits	Bits
 slot 1.0 - 1.5 - 2.0 - 2.5 - 3.0	 square S0 - S1
 cross-recess PH000-PH00-PH0-PH1	 hex 0.9 - 1.3 - 1.5 - 2.0 - 2.5 - 3.0
 torx T3-T4-T5-T6-T7-T8-T9-T10-T15	 pentalobe P2 - P5 -P6
 triangle 1.6 - 2.0 - 2.2 - 2.3	 nut setter 2.5 - 3.0 - 3.5 - 4.0 - 4.5 - 5.0
 tri-point 0 -1	 SIM-eject

► 6-340

4 mm Bit Set 44 pcs (without box)

3 bit bars with 36 special bits (sizes see 6-340-3)
 1 bit bar with 6 nut setters
 Quality steel sandblasted nickel-plated 52-54 HRC
 + ESD handle (dissipative 10⁶ to 10⁹ Ohm)
 + Bit extension 115 mm
 Dimensions bit bars. 65 x 8 x 28 mm, weight 157 g



► 6-350

4 mm Bit Set 45 pcs with ESD-Box

3 bit bars with 36 special bits (sizes see 6-340-3)
 1 bit bar with 6 nut setters
 Quality steel sandblasted nickel-plated 52-54 HRC
 + ESD handle (dissipative 10⁶ to 10⁹ Ohm)
 + Bit extension 115 mm
 + Bit adapter 1/4 inch to 4 mm
 Dimensions box 135 x 85 x 20 mm, weight 215 g



► 4-910

4 mm Bit Case 47 pcs

3 bit bars with 36 special bits (sizes see 6-340-3)
 1 bit bar with 6 nut setters
 Quality steel sandblasted nickel-plated 52-54 HRC
 + ESD handle (dissipative 10⁶ to 10⁹ Ohm)
 + Bit extension 115 mm
 + LCD opener suction cup with ring
 + Opening tool, metal opener flat
 + ESD SMD tweezers 120mm form 2a stainless steel (dissipative 10⁶ to 10⁹ Ohm)
 Dimensions case 175 x 160 x 45 mm, weight 420 g





ESD ELECTRONICS SCREWDRIVER TOOL

























For all work on electrostatically sensitive components. The blades are made of quality steel to ensure torsion resistance - at maximum stress. The tips are burnished for dimensional stability and to prevent chrome chipping (except sockets). The rotating cap is smooth-running and allows the screwdriver to be held in position despite starting pressure. Thanks to the ergonomically shaped handle, the screwdriver fits perfectly in the hand. 100% Made in Germany.



The following types are available, specifications in mm:



Art.-No.	Symbol	Size / drive	Blade length	Blade width	Blade thickness	Blade diameter	Handle length	Total length	Weight in g
4-603		slot	60	1.5	0.25	2.5	100	160	16
4-605		slot	60	2.0	0.40	2.5	100	160	16
4-606		slot	60	2.5	0.40	2.5	100	160	16
4-607		slot	60	3.0	0.50	3.0	100	160	18
4-608		slot	60	3.5	0.60	3.5	100	160	18
4-609		slot	60	4.0	0.80	4.0	100	160	18
4-621		PH000	60	—	—	2.5	100	160	16
4-622		PH00	60	—	—	2.5	100	160	16
4-623		PH0	60	—	—	3.0	100	160	16
4-624		PH1	80	—	—	4.5	100	180	20

Art.-No.	Symbol	Size / drive	Blade length	Blade width	Blade thickness	Blade diameter	Handle length	Total length	Weight in g
6-611		socket wrench	60	1.5	–	2.5	100	160	18
6-612		socket wrench	60	2.0	–	3	100	160	20
6-613		socket wrench	60	2.5	–	4	100	160	22
6-614		socket wrench	60	3.0	–	5	100	160	24
6-616		socket wrench	60	3.5	–	5.3	100	160	26
6-617		socket wrench	60	4.0	–	5.5	100	160	28
6-618		socket wrench	60	4.5	–	6.2	100	160	30
6-619		socket wrench	60	5.0	–	6.8	100	160	32
6-621		socket wrench	60	5.5	–	7.6	100	160	34
6-631		allen key	50	0.7	–	2.5	100	150	14
6-632		allen key	50	0.9	–	2.5	100	150	14
6-633		allen key	50	1.3	–	2.5	100	150	14
6-634		allen key	50	1.5	–	2.5	100	150	14
6-635		allen key	50	2.0	–	2.5	100	150	14
6-636		allen key	60	2.5	–	3.0	100	160	16
6-656		T1	50	–	–	2.5	100	150	14
6-657		T2	50	–	–	2.5	100	150	14
6-658		T3	50	–	–	2.5	100	150	14
6-659		T4	50	–	–	2.5	100	150	14
6-661		T5	50	–	–	2.5	100	150	14
6-662		T6	50	–	–	3.5	100	150	15
6-663-L		T7 with hole	50	–	–	3.5	100	150	15
6-664-L		T8 with hole	60	–	–	3.5	100	160	16
6-665-L		T9 with hole	60	–	–	4.0	100	160	18
6-666-L		T10 with hole	80	–	–	4.0	100	180	20

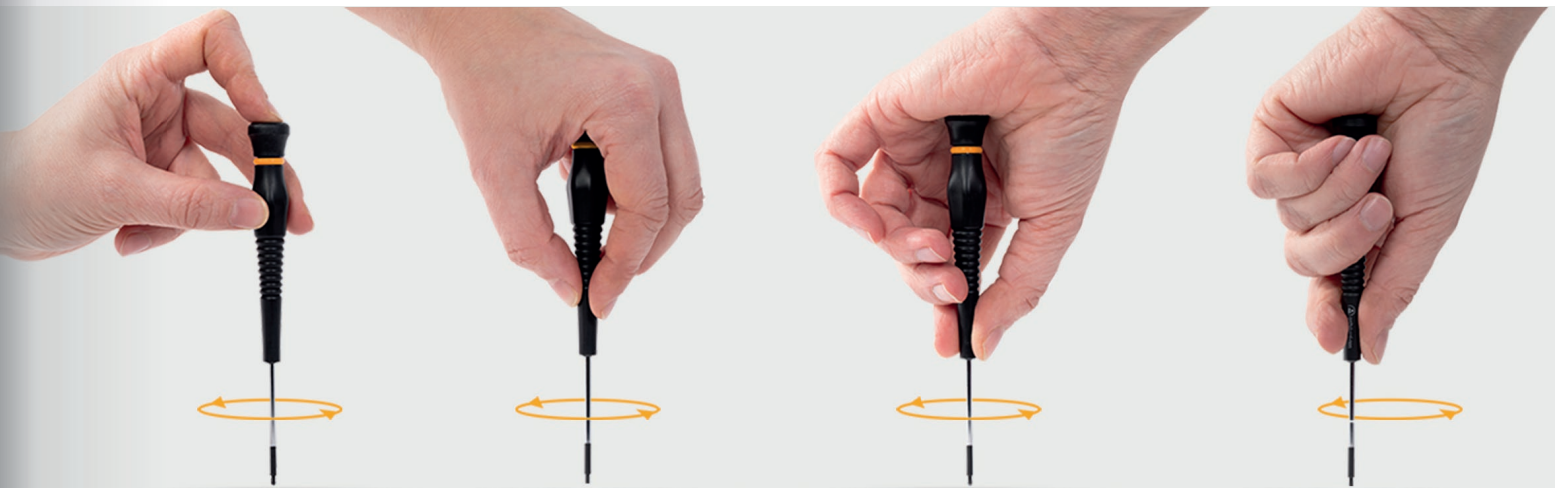



TOOL HOLDER

STOREY

For more organisation at your workstation

The STOREY tool holder was developed as practical storage for hand tools so that your tools are always within reach. Whether as a table stand or wall holder.

Holder made of 1.5 mm sheet steel
ESD powder coated RAL9005
dissipative 10^5 - 10^9 Ohm
100% Made in Germany



ESD ELECTRONIC SCREWDRIVERS

The ergonomic handle of the screwdriver is made of ESD plastic (PP black) and has a surface resistance of 10^5 to 10^7 Ohm. The matt chrome-plated blade is made of high-quality chrome-molybdenum steel (hardness greater than 55 HRC) according to DIN ISO and is hardened over its entire length. 100% Made in Germany.

► 4-610

ESD slotted screwdriver set 6 pcs

for hanging or standing
weight: 277 g

Art.-No.	Content
4-603	⊖ slot blade 1.5 x 0.25 x 60 mm
4-605	⊖ slot blade 2.0 x 0.4 x 60 mm
4-606	⊖ slot blade 2.5 x 0.4 x 60 mm

Art.-No.	Content
4-607	⊖ slot blade 3.0 x 0.5 x 60 mm
4-608	⊖ slot blade 3.5 x 0.6 x 60 mm
4-609	⊖ slot blade 4.0 x 0.8 x 60 mm



► 4-620

ESD cross-recess screwdriver set 6 pcs

for hanging or standing
weight: 270 g



Art.-No.	Content
4-603	⊖ slot blade 1.5 x 0.25 x 40 mm
4-605	⊖ slot blade 2.0 x 0.4 x 40 mm
4-607	⊖ slot blade 3.0 x 0.5 x 50 mm



Art.-No.	Content
4-621	⊕ cross-recess PH000
4-622	⊕ cross-recess PH00
4-623	⊕ cross-recess PH0



6-610**ESD socket wrench-screwdriver set 6 pcs**



for hanging or standing
weight: 317 g

Art.-No.	Content
6-612	 ESD hex socket wrench 2.0 mm
6-614	 ESD hex socket wrench 3.0 mm
6-617	 ESD hex socket wrench 4.0 mm

Art.-No.	Content
6-618	 ESD hex socket wrench 4.5 mm
6-619	 ESD hex socket wrench 5.0 mm
6-621	 ESD hex socket wrench 5.5 mm

**▶ 6-630****ESD allen key screwdriver set 6 pcs**



for hanging or standing
weight: 262 g



Art.-No.	Content
6-631	 ESD allen key hex 0.7 mm
6-632	 ESD allen key hex 0.9 mm
6-633	 ESD allen key hex 1.3 mm

Art.-No.	Content
6-634	 ESD allen key hex 1.5 mm
6-635	 ESD allen key hex 2.0 mm
6-636	 ESD allen key hex 2.5 mm

**▶ 6-660****ESD torx screwdriver set 6 pcs**

for hanging or standing
weight: 286 g

Art.-No.	Content
6-661	 TORX T5
6-662	 TORX T6
6-663 L	 TORX T7 with hole



Art.-No.	Content
6-664 L	 TORX T8 with hole
6-665 L	 TORX T9 with hole
6-666 L	 TORX T10 with hole



ESD ELECTRONICS SCREWDRIVER SETS

▶ 2100**ESD tool set VARIO 6 pcs**

for hanging or standing
weight: 445 g

Art.-No.	Content
5-090-0	ESD tool holder VARIO 8 slots
3-604-15	ESD side cutters CLASSICline flush 115 mm
3-633-15	ESD snipe nose pliers CLASSICline 120 mm
4-603	 ESD screwdriver slot blade 1.5 x 0.25 x 60 mm
4-621	 ESD screwdriver cross-recess PH000
5-055-13	ESD SMD tweezers 120mm form 7a stainless steel angle 40° dissipative
5-068-13	ESD SMD tweezers 120mm form 13 stainless steel angle 45° dissipative





► 4-610-VC

ESD screwdriver set VARIO 8 pcs

Tool holder made of steel with dissipative coating RAL9005

Surface resistance $10^5 - 10^9$ Ohm, for hanging or standing, weight: 520 g

Art.-No.	Content
5-090-0	ESD tool holder VARIO 8 slots
4-603	⊖ ESD screwdriver slot blade 1.5 x 0.25 x 60 mm
4-605	⊖ ESD screwdriver slot blade 2.0 x 0.4 x 60 mm
4-606	⊖ ESD screwdriver slot blade 2.5 x 0.4 x 60 mm
4-607	⊖ ESD screwdriver slot blade 3.0 x 0.5 x 60 mm
4-608	⊖ ESD screwdriver slot blade 3.5 x 0.6 x 60 mm
4-609	⊖ ESD screwdriver slot blade 4.0 x 0.8 x 60 mm
3-604-15	ESD side cutters CLASSICline flush 115mm
5-055-13	ESD SMD tweezers 120mm form 7a stainless steel angle 40° dissipative



► 4-620-VC

ESD screwdriver set VARIO 8 pcs

Tool holder made of steel with dissipative coating RAL9005

Surface resistance $10^5 - 10^9$ Ohm, for hanging or standing, weight: 545 g

Art.-No.	Content
5-090-0	ESD tool holder VARIO 8 slots
4-603	⊖ ESD screwdriver slot blade 1.5 x 0.25 x 60 mm
4-605	⊖ ESD screwdriver slot blade 2.0 x 0.4 x 60 mm
4-607	⊖ ESD screwdriver slot blade 3.0 x 0.5 x 60 mm
4-621	⊕ ESD screwdriver cross-recess PH000
4-622	⊕ ESD screwdriver cross-recess PH00
4-623	⊕ ESD screwdriver cross-recess PH0
3-604-15	ESD side cutters CLASSICline flush 115mm
5-055-13	ESD SMD tweezers 120mm form 7a stainless steel angle 40° dissipative





▶ 6-630-VC

ESD allen key tool set VARIO 8 pcs

Tool holder made of steel with dissipative coating RAL9005

Surface resistance $10^5 - 10^9$ Ohm, for hanging or standing, weight: 520 g

Art.-No.	Content
5-090-0	ESD tool holder VARIO 8 slots
6-631	 ESD allen key hex 0.7 mm
6-632	 ESD allen key hex 0.9 mm
6-633	 ESD allen key hex 1.3 mm
6-634	 ESD allen key hex 1.5 mm
6-635	 ESD allen key hex 2.0 mm
6-636	 ESD allen key hex 2.5 mm
3-604-15	ESD side cutters CLASSICline flush 115mm
5-055-13	ESD SMD tweezers 120mm form 7a stainless steel angle 40° dissipative



▶ 6-610-VC

ESD socket wrench tool set VARIO 8 pcs

Tool holder made of steel with dissipative coating RAL9005

Surface resistance $10^5 - 10^9$ Ohm, for hanging or standing, weight: 575 g

Art.-No.	Content
5-090-0	ESD tool holder VARIO 8 slots
6-612	 ESD hex socket wrench 2.0 mm
6-614	 ESD hex socket wrench 3.0 mm
6-617	 ESD hex socket wrench 4.0 mm
6-618	 ESD hex socket wrench 4.5 mm
6-619	 ESD hex socket wrench 5.0 mm
6-621	 ESD hex socket wrench 5.5 mm
3-604-15	ESD side cutters CLASSICline flush 115mm
5-055-13	ESD SMD tweezers 120mm form 7a stainless steel angle 40° dissipative









▶ 6-660-VC

ESD Torx tool set VARIO 8 pcs

Tool holder made of steel with dissipative coating RAL9005

Surface resistance $10^5 - 10^9$ Ohm, for hanging or standing, weight: 555 g

Art.-No.	Content
5-090-0	ESD tool holder VARIO 8 slots
6-661	 ESD screwdriver TORX T5
6-662	 ESD screwdriver TORX T6
6-663 L	 ESD screwdriver TORX T7 with hole
6-664 L	 ESD screwdriver TORX T8 with hole
6-665 L	 ESD screwdriver TORX T9 with hole
6-666 L	 ESD screwdriver TORX T10 with hole
3-604-15	ESD side cutters CLASSICline flush 115mm
5-055-13	ESD SMD tweezers 120mm form 7a stainless steel angle 40° dissipative



ESD INTERCHANGEABLE SCREWDRIVER SETS

ESD interchangeable screwdrivers, single or in a set, in a practical roll-up case made of dissipative material (10^6 - 10^9 Ohm), equipped with double-sided screwdriver blades and an interchangeable ESD plastic handle. The holder is a brass clamping sleeve, suitable for all hexagon interchangeable blades with 4 mm wrench width. The blades are made of high-quality chrome vanadium steel, hardened over their entire length (HRC 56-58), matt chrome-plated, tip black burnished.

The following types are available, specifications in mm:



Art.-No.	Symbol	Size / drive	Blade length	Blade width	Blade thickness	Blade diameter	Handle length	Total length	Weight in g
4-901	Handle	—	—	—	—	—	85	105	16
4-905	⊖	Slot	120	1.5/3.0	0.4/0.6	4.5	—	120	12
4-906	⊖	Slot	120	2.0/3.5	0.4/0.6	4.5	—	120	12
4-907	⊖	Slot	120	2.5/4.0	0.6/0.9	4.5	—	120	12
4-911	⊕	PH00/PH000	120	2.0/1.5	0.8/0.76	4.5	—	120	12
4-912	⊕	PH0/PH1	120	3.0/4.5	0.84/1.3	4.5	—	120	12
4-919	★	T3/T4	120	1.12/1.30	—	4.5	—	120	12
4-921	★	T5/T6	120	1.37/1.65	—	4.5	—	120	12
4-922 L	★	T7/T8	120	1.97/2.30	—	4.5	—	120	12
4-923 L	★	T9/T10	120	2.48/2.72	—	4.5	—	120	12
4-932	⊗	TW0/FW0	120	—	0.45	4.5	—	120	12
4-933	⊗	TW1/FW1	120	—	0.57	4.5	—	120	12
4-934	⊗	TW2/FW2	120	—	0.75	4.5	—	120	12

▶ 4-920 ESD screwdriver set 9 pcs

Art.-No.	Content
4-960-0	ESD dissipative roll-up case 11 empty compartments
4-901	ESD interchangeable handle
4-905	⊖ Interchangeable blade slot 1.5/3.0mm
4-906	⊖ Interchangeable blade slot 2.0/3.5 mm
4-907	⊖ Interchangeable blade slot 2.5/4.0 mm
4-911	⊕ Interchangeable blade PH00/PH000
4-912	⊕ Interchangeable blade PH0/PH1
4-921	★ Interchangeable blade TORX T5/T6
4-922 L	★ Interchangeable blade TORX T7/T8
4-923 L	★ Interchangeable blade TORX T9/T10

▶ 4-960 ESD screwdriver set 12 pcs

Art.-No.	Content
4-960-0	ESD dissipative roll-up case 11 empty compartments
4-901	ESD interchangeable handle
4-905	⊖ Interchangeable blade slot 1.5/3.0mm
4-907	⊖ Interchangeable blade slot 2.5/4.0 mm
4-911	⊕ Interchangeable blade PH00/PH000
4-912	⊕ Interchangeable blade PH0/PH1
4-919	★ Interchangeable blade TORX T3/T4
4-921	★ Interchangeable blade TORX T5/T6
4-922 L	★ Interchangeable blade TORX T7/T8
4-923 L	★ Interchangeable blade TORX T9/T10
4-932	⊗ Interchangeable blade TW0/FW0
4-933	⊗ Interchangeable blade TW1/FW1
4-934	⊗ Interchangeable blade TW2/FW2



BITS AND BIT SETS

► 4-950

Screwdriver set 13 pcs

Contents 1 handle and 6 bit blades Ø 4 mm (5/32 inch)

Space for 5 blades, blades nickel-plated, tips burnished, 58-62 HRC

Working length, extendable from 18 to 72 mm

Length 115 mm, weight 112 g

Bits	Description
	Slot 1.5 - 2.5
	Cross-recess PH0 - PH00
	Torx T6 - T8 - T9 - T10
	Hex 1.5 - 2.0 - 2.5 - 3.0



Practical aluminum handle with integrated, smooth-running magazine (with lock-function) for up to 5 high-quality bit blades or bits with a diameter of 4 mm.



► 4-951

Schraubendreher Satz 33-tlg. (12 Bits im Griff)

Contents 1 handle and 32 bits sizes, Ø 4 mm (5/32 inch)

Space for 15 blades, blades nickel-plated, tips burnished, 58-62 HRC

length 165 mm, weight 105 g

Bits	Beschreibung
	Schlitz 1.0 - 1.5 - 2.0 - 2.5 - 3.0 - 3.5 - 4.0 mm
	Kreuz-Schlitz PH000 - PH00 - PH0 - PH1 - PZ0 - PZ1
	Torx T4 - T5 - T6 - T7 - T8 - T9 - T10 - T15 - T20
	Sechskant 0.5-0.7-0.9-1.5-2.0-2.5-3.0-4.0 mm 1/16 - 3/32



These handy precision screwdrivers are perfect for technical instruments or devices, both in professional use and for the do-it-yourselfer or hobbyist.



▶ 6-350

NEW

ESD Bit-Box 45 pcs

3 bit bars equipped with 36 special bits and 1 bit bar with 6 nut setter
 4mm (5/32 inch) hex bits, blade length 22 mm, blades Ø 8 mm
 quality steel sandblasted and nickel-plated 52-54 HRC
 Dimensions box inside 130x80x14, outside 135x85x20 mm, weight 215 g

Art.-No.	Content
6-340-3	C4-Bit-Satz 42 tlg, bestehend aus: Slot 1.0 - 1.5 - 2.0 - 2.5 - 3.0 Cross-recess PH000 - PH00 - PH0 - PH1 Torx T3 - T4 - T5 - T6 - T7 - T8 - T9 - T10 - T15 Hex 0.9 - 1.3 - 1.5 - 2.0 - 2.5 - 3.0 Wrench 2.5 - 3.0 - 3.5 - 4.0 - 4.5 - 5.0 Triangle 1.6 - 2.0 - 2.2 - 2.3 / Square S0 - S1 Pentalobe P2 - P5 - P6 / SIM-Eject / Tri-Point 0 - 1
6-340-2	Bit extension 115 mm
6-340-1	ESD Bit holder dissipative 10 ⁶ to 10 ⁹ Ohm
4-564	Bit adapter 1/4 inch to 4mm, length 42.5 mm



▶ 6-355

NEW

1/4 Zoll Bit-Box 30 pcs

Screwdriver handle with bit magnetic holder 1/4 inch (SW6.35)
 C6.3 Bits length 25 mm, according to DIN standard, Bits made of tool steel 58-60 HRC
 in a practical folding out box with a hanger on the back, Dimensions box outside 160x100x45 mm
 weight 384 g

Art.-No.	Content
6-340-3	1/4 inch bit set consisting of: Slot 3.0 - 3.5 - 4.0 - 5.0 Cross-recess PH0 - PH1 - PH2 (2x) Pozi drive PZ1 - PZ2 (2x each) Torx T5 - T6 - T7 - T8 - T9 - T10 - T15 - T20 - T25 Hex 1.5 - 2.0 - 2.5 - 3.0 - 4.0 (2x) - 5.0 - 6.0
4-107	screwdriver handle with bit magnetic holder



▶ 6-355-ESD

NEW

1/4 Inch Bit-Box 30 pcs with ESD Handle

ESD Screwdriver handle with bit magnetic holder 1/4 inch (SW6.35)
 C6.3 Bits length 25 mm, according to DIN standard, Bits made of tool steel 58-60 HRC
 in a practical folding out box with a hanger on the back, Dimensions box outside 160x100x45 mm
 weight 384 g

Art.-No.	Content
6-340-3	1/4 inch bit set consisting of: Slot 3.0 - 3.5 - 4.0 - 5.0 Cross-recess PH0 - PH1 - PH2 (2x) Pozi drive PZ1 - PZ2 (2x each) Torx T5 - T6 - T7 - T8 - T9 - T10 - T15 - T20 - T25 Hex 1.5 - 2.0 - 2.5 - 3.0 - 4.0 (2x) - 5.0 - 6.0
4-107	ESD Screwdriver handle with bit magnetic holder

ITEM LIKE 6-355,
 ONLY WITH
 ESD HANDLE 4-117

ESD SCREWDRIVERS



The ergonomic handle of the screwdriver is made of ESD plastic (PP black) and has a surface resistance of 10^5 to 10^7 Ohm. The matt chrome-plated blade is made of high-quality chrome-molybdenum steel (hardness over 55 HRC) according to DIN ISO and is hardened over its entire length.

For all work on electrostatically sensitive components. The blades are specially hardened to ensure torsion resistance even under maximum stress. The tips are burnished for dimensional stability and to prevent chrome chipping. Thanks to the ergonomically shaped handle, the screwdriver fits perfectly in the hand.



The following types are available, specifications in mm:

Art.-No.	Symbol	Size / drive	Blade length	Blade width	Blade thickness	Blade diameter	Handle length	Total length	Weight in g
4-632		Slot	100	4.0	0.8	4.0	90	190	40
4-633		Slot	125	5.5	1.0	6.0	100	225	65
4-652		PH1	80	–	–	4.5	90	170	40
4-653		PH2	100	–	–	6.0	100	200	75

SCREWDRIVERS POWERLINE

For the professional user as well as for the hobby craftsman a durable hand tool. The chrome-plated blade is made of a high quality chrome vanadium steel and hardened over its entire length. The tip is burnished for perfect dimensional stability and to avoid chrome chips. The ergonomically shaped multi-component handle is slip-proof, impact-resistant and has a practical hanging hole for your workbench. 100% Made in Germany.

The quality is particularly evident in the manufacturing process of the blade. During quality testing, the blade is clamped in a torque test rig and twisted until it breaks smoothly. According to DIN, this has to be done in a very specific Newton metre range. Only a smooth fracture is safe! Low quality products can splinter or tear, which can be extremely dangerous.

SLOT



CROSS-RECESS



TORX



SOCKET WRENCH



The following types are available, specifications in mm:







Art.-No.	Symbol	Size / drive	Blade length	Blade width	Blade thickness	Blade diameter	Handle length	Handle size	Total length	Weight in g
4-331		Slot	50	6	1	3,0	100	1	150	34
4-521		Slot	75	2.5	0.4	2.5	100	1	175	26
4-522		Slot	75	3	0.5	3	100	1	175	27
4-523		Slot	100	4	0.8	4	100	1	200	36
4-524		Slot	153	5	1	5.5	107	2	260	74
4-504		Slot	100	5.5	1	6	107	2	207	62
4-506		Slot	126	6.5	1.2	6	114	3	240	93
4-508		Slot	150	8	1.2	8	121	4	271	141
4-532		PH0	60	–	–	3	100	1	160	28
4-533		PH1	80	–	–	4.5	107	2	187	55
4-534		PH2	101	–	–	6	114	3	215	84
4-542		PZ0	60	–	–	3	100	1	160	28
4-543		PZ1	80	–	–	4.5	107	2	187	55
4-544		PZ2	101	–	–	6	114	3	215	90
6-979		T5	56	1.37	–	3.5	100	1	156	25
6-981		T6	66	1.65	–	3.5	100	1	166	29
6-983 L		T8	75	2.30	–	3.5	100	1	175	29
6-984 L		T9	75	2.48	–	4	100	1	175	29
6-985 L		T10	85	2.72	–	4	100	1	185	32
6-986 L		T15	85	3.26	–	4	100	1	185	34
6-987 L		T20	100	3.84	–	4	100	1	200	35
6-104		5	128	–	–	2	107	2	235	50
6-105		5.5	128	–	–	2	107	2	235	50
6-107		7	128	–	–	2	107	2	235	78

*Griffgröße: 1: 100 x 21 mm, 2: 107 x 27 mm, 3: 114 x 32 mm, 4: 121 x 35 mm

► 4-530

Screwdriver set POWERline 7pcs

Blade matt chrome-plated, tip burnished, material chrome-vanadium-molybdenum steel
HRC 56-58, Blade matt chrome plated, tip burnished, plastic handle non-slip impact resistant
100% Made in Germany, weight 520 g

Art.-No.	Content
4-343 VDE	 VDE voltage tester slot blade 3.0 x 0.7 x 60 mm
4-504	 Screwdriver POWERline slot blade 5.5 x 1.0 x 100 mm
4-506	 Screwdriver POWERline slot blade 6.5 x 1.2 x 125 mm
4-523	 Screwdriver POWERline slot blade 4.0 x 0.8 x 100 mm
4-524	 Screwdriver POWERline slot blade 5.0 x 1.0 x 150 mm
4-533	 Screwdriver POWERline cross-recess PH1
4-534	 Screwdriver POWERline cross-recess PH2





SCREWDRIVER FOR SPECIAL REQUIREMENTS

► **MINI Screwdriver short**

Material chrome-vanadium-molybdenum steel HRC 56-58
Plastic handle ergonomically shaped impact resistant





Art.-No.	Symbol	Size / drive	Blade length	Blade width	Blade thickness	Blade diameter	Handle length	Total length	Weight in g
4-321		Slot	25	4.0	0.8	4.0	55	80	30
4-261		PH1	25	—	—	4.5	55	80	30

► **Grub-Screwdriver**

for loosening the grub screws or worm screws
Material tool steel blade, plastic handle hard stable





Art.-No.	Symbol	Size / drive	Stück	Blade length	Blade width	Blade thickness	Blade diameter	Handle length	Total length	Weight in g
4-311		Slot	1	80	2.8	0.6	3.0	60	140	10
4-302-VE10		Slot	10	80	2.8	0.6	3.0	60	140	50

► **Liliput screwdriver**

Material tool steel, blade width 2.0 with a tolerance of +/-0.2 mm



Art.-No.	Symbol	Size / drive	Stück	Blade length	Blade width	Blade thickness	Blade diameter	Handle length	Total length	Weight in g
4-301		Slot	1	40	2,0	0.5 - 0.65	2.0	45	85	3
4-301-VE10		Slot	10	40	2,0	0.5 - 0.65	2.0	45	85	40

► 4-820

Liliput screwdriver set 60 pcs in holder

Set of Art-No. 4-301 (blue plastic stand) total weight 235 g



► 4-351

Offset screwdriver

plastic handle hard stable, blade Ø 4.0 mm, blade width 4 mm, blade thickness 0.8 mm
material chrome vanadium molybdenum steel HRC 56-58, length 100 mm, weight 12 g



MINI-ALU-SCREWDRIVERS

High-precision screwdrivers according to factory standard
 Aluminium handle with smooth-running rotating cap
 Radial concentricity with optimal adhesion
 Blades molybdenum-vanadium steel burnished
 Glare-free even in high light
 Precision blade hardened HRC 58-61
 100% Made in Germany



The rotating cap enables optimum handling for particularly tricky cases.



The knurling ensures a particularly good grip.

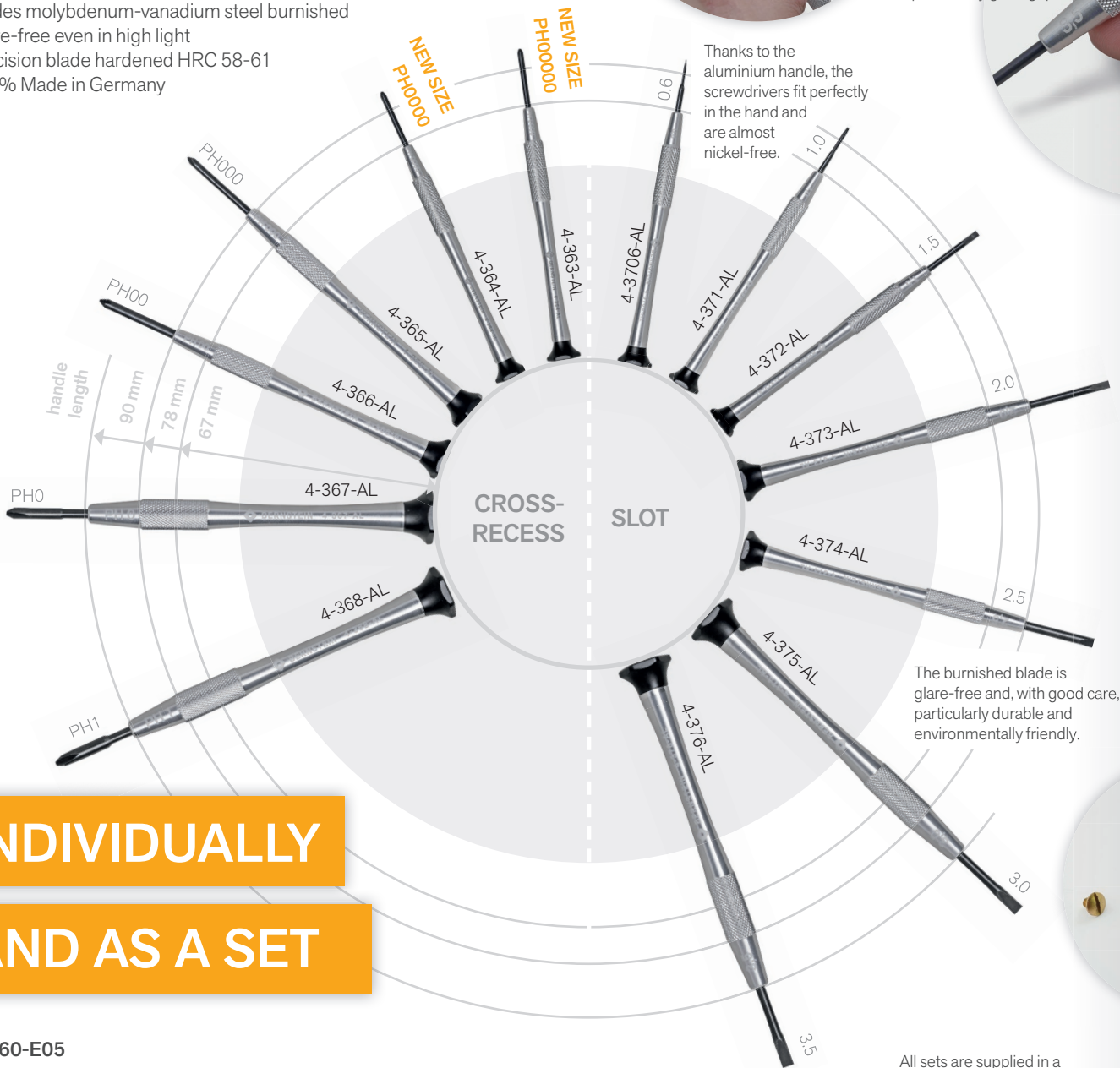

Thanks to the aluminium handle, the screwdrivers fit perfectly in the hand and are almost nickel-free.

The burnished blade is glare-free and, with good care, particularly durable and environmentally friendly.

INDIVIDUALLY

AND AS A SET

► 4-360-E05

Watchmakers screwdriver set 7 pcs

In plastic case

Weight: 111 g

Art.-No.	Content
4-372-AL	⊖ Watchmaker screwdriver slot blade 1.5 x 0.23 x 16 mm
4-373-AL	⊖ Watchmaker screwdriver slot blade 2.0 x 0.4 x 22 mm
4-374-AL	⊖ Watchmaker screwdriver slot blade 2.5 x 0.4 x 22 mm
4-375-AL	⊖ Watchmaker screwdriver slot blade 3.0 x 0.5 x 22 mm
4-376-AL	⊖ Watchmaker screwdriver slot blade 3.5 x 0.6 x 22 mm
4-367-AL	⊕ Watchmaker screwdriver cross-recess PH0
4-368-AL	⊕ Watchmaker screwdriver cross-recess PH1

All sets are supplied in a handy plastic case.



WATCHMAKER SCREWDRIVERS

CROSS-RECESS



SLOT



The following types are available, specifications in mm:

Art.-No.	Symbol	Size / drive	Blade length	Blade width	Blade thickness	Blade diameter	Handle length	Total length	Weight in g
4-363-AL		PH00000	16	1.0	—	1.0	66	82	3
4-364-AL		PH0000	16	1.5	—	1.5	66	82	3
4-365-AL		PH000	22	2.0	—	2.0	78	100	5
4-366-AL		PH00	22	2.5	—	2.5	78	100	5
4-367-AL		PH0	22	3.0	—	3.0	90	112	9.5
4-368-AL		PH1	22	3.5	—	3.5	90	112	9.5
4-3706-AL		Slot	14	0.6	0.15	1.0	67	81	3
4-371-AL		Slot	14	1.0	0.20	1.0	67	81	3
4-372-AL		Slot	16	1.5	0.23	1.5	67	83	3
4-373-AL		Slot	22	2.0	0.40	2.0	78	100	5
4-374-AL		Slot	22	2.5	0.40	2.5	78	100	5.5
4-375-AL		Slot	22	3.0	0.50	2.5	90	112	9.5
4-376-AL		Slot	22	3.5	0.60	2.5	90	112	9.5

▶ 4-360-E01

Watchmakers screwdriver set 3pcs (slot)

In plastic case

Weight: 17 g

Art.-No.	Content
4-3706-AL	Watchmaker screwdriver slot blade 0.6 x 0.15 x 14 mm
4-371-AL	Watchmaker screwdriver slot blade 1.0 x 0.2 x 14 mm
4-372-AL	Watchmaker screwdriver slot blade 1.5 x 0.23 x 16 mm

▶ 4-360-E02

Watchmakers screwdriver set 3pcs (PH)

In plastic case

Weight: 22 g

Art.-No.	Content
4-364-AL	Watchmaker screwdriver cross-recess PH0000
4-365-AL	Watchmaker screwdriver cross-recess PH000
4-366-AL	Watchmaker screwdriver cross-recess PH00

▶ 4-360-E03

Watchmakers screwdriver set 6pcs (slot)

In plastic case

Weight: 37 g

Art.-No.	Content
4-3706-AL	Watchmaker screwdriver slot blade 0.6 x 0.15 x 14 mm
4-371-AL	Watchmaker screwdriver slot blade 1.0 x 0.2 x 14 mm
4-372-AL	Watchmaker screwdriver slot blade 1.5 x 0.23 x 16 mm
4-373-AL	Watchmaker screwdriver slot blade 2.0 x 0.4 x 22 mm
4-374-AL	Watchmaker screwdriver slot blade 2.5 x 0.4 x 22 mm
4-375-AL	Watchmaker screwdriver slot blade 3.0 x 0.5 x 22 mm

▶ 4-360-E04

Watchmakers screwdriver set 6pcs

In plastic case

Weight: 30 g







Art.-No.	Content
4-3706-AL	Watchmaker screwdriver slot blade 0.6 x 0.15 x 14 mm
4-371-AL	Watchmaker screwdriver slot blade 1.0 x 0.2 x 14 mm
4-372-AL	Watchmaker screwdriver slot blade 1.5 x 0.23 x 16 mm
4-364-AL	Watchmaker screwdriver cross-recess PH0000
4-365-AL	Watchmaker screwdriver cross-recess PH000
4-366-AL	Watchmaker screwdriver cross-recess PH00

► Watchmaker screwdriver magazine 6 pcs.

Material tool steel HRC 58-61

Metal handle with rotating cap (nickel-plated), for opening with blades inside

Weight: 33 g

Art. No.	4-392	4-393
 Slot 1,5 mm	✓	✓
 Slot 2,0 mm	✓	✓
 Slot 2,5 mm	✓	✓
 Slot 3,0 mm	✓	✓
 Cross recess PH0	✓	
 Cross recess PH00		✓
 Cross recess PH000		✓



4-392, 4-393

MICRO SCREWDRIVER

Fine screwdrivers are also called micro screwdrivers and are used in precision mechanics for small screw sizes or miniature screws. The hard precision blade made of quality tool steel enables direct gripping of the miniature screw and provides optimum force closure. The sturdy plastic handle with rotation cap fits comfortably in the hand, the coloured ring facilitates work by quickly recognising the required size.

Blade (HRC 58-61) material molybdenum-vanadium steel, burnished black, handle plastic. 100% Made in Germany.















Instructions: High humidity or touching burnished blades with your fingers (sweat) causes flash rust. Therefore, the blades should always be kept dry or rubbed with a drop of oil for storage. If such rust forms on the blade, it can be easily removed, with a slight ground.

Blades are burnished to prevent the chrome from flaking off and to achieve absolute top dimensional stability.



4-380-14

The following types are available, specifications in mm:

Art.-No.	Symbol	Size / drive	Blade length	Blade width	Blade thickness	Blade diameter	Handle length	Total length	Weight in g
NEW 4-380-06		Slot	17	0.6	0.15	2.0	87	104	4
NEW 4-380-08		Slot	17	0.8	0.19	2.0	87	104	4
4-380-10		Slot	17	1.0	0.20	2.0	87	104	4
NEW 4-380-12		Slot	17	1.2	0.25	2.0	87	104	4
4-380-14		Slot	17	1.4	0.25	2.0	87	104	4
4-380-18		Slot	17	1.8	0.30	2.0	87	104	4
NEW 4-380-20		Slot	17	2.0	0.40	2.0	87	104	4
4-380-23		Slot	17	2.3	0.40	2.5	87	104	4
NEW 4-380-25		Slot	17	2.5	0.40	2.5	87	104	4
4-380-30		Slot	17	3.0	0.50	2.5	87	104	4
NEW 4-380-90		PH1	17	-	-	2.5	87	104	4
NEW 4-380-91		PH0	17	-	-	2.5	87	104	4
NEW 4-380-92		PH00	17	-	-	2.5	87	104	4
NEW 4-380-93		PH000	17	-	-	2.0	87	104	4
NEW 4-380-94		PH0000	17	-	-	2.0	87	104	4

▶ 4-380

Micro screwdriver slot set 5 pcs

Box measures 105 x 65 x 20 mm, weight 64 g

Art.-No.	Content	Color
4-380-0	Plastic box blue	
4-380-10	Slot blade 1.0 x 0.20 x 17 mm	●
4-380-14	Slot blade 1.4 x 0.25 x 17 mm	●
4-380-18	Slot blade 1.8 x 0.30 x 17 mm	●
4-380-23	Slot blade 2.3 x 0.40 x 17 mm	●
4-380-30	Slot blade 3.0 x 0.50 x 17 mm	●



4-380

▶ 4-380-A

Micro screwdriver slot + PH set 5 pcs

Box measures 105 x 65 x 20 mm, weight 64 g

NEW

Art.-No.	Content	Color
4-380-0	Plastic box blue	
4-380-06	Slot blade 1.0 x 0.20 x 17 mm	●
4-380-08	Slot blade 2.0 x 0.40 x 17 mm	○
4-380-10	Slot blade 3.0 x 0.50 x 17 mm	●
4-380-12	Phillips Recess Blade PH00	●
4-380-14	Phillips Recess Blade PH000	○



4-380-A

▶ 4-380-F

Micro screwdriver slot 0.6 - 1.4 set 5 pcs

Box measures 105 x 65 x 20 mm, weight 64 g

NEW

Art.-No.	Content	Color
4-380-0	Plastic box blue	
4-380-06	Slot blade 0.6 x 0.15 x 17 mm	●
4-380-08	Slot blade 0.8 x 0.19 x 17 mm	●
4-380-10	Slot blade 1.0 x 0.20 x 17 mm	●
4-380-12	Slot blade 1.2 x 0.25 x 17 mm	●
4-380-14	Slot blade 1.4 x 0.25 x 17 mm	●



4-380-F

▶ 4-380-G

Micro screwdriver slot 1.8 - 3.0 set 5 pcs

Box measures 105 x 65 x 20 mm, weight 64 g

NEW

Art.-No.	Content	Color
4-380-0	Plastic box blue	
4-380-06	Slot blade 1.8 x 0.23 x 17 mm	●
4-380-08	Slot blade 2.0 x 0.40 x 17 mm	○
4-380-10	Slot blade 2.3 x 0.40 x 17 mm	●
4-380-12	Slot blade 2.5 x 0.40 x 17 mm	●
4-380-14	Slot blade 3.0 x 0.50 x 17 mm	●



4-380-G

▶ 4-380-PH

Micro screwdriver PH set 5 pcs

Box measures 105 x 65 x 20 mm, weight 64 g

NEW

Art.-No.	Content	Color
4-380-0	Plastic box blue	
4-380-90	Phillips Recess Blade PH1	●
4-380-91	Phillips Recess Blade PH0	●
4-380-92	Phillips-Recess Blade PH00	●
4-380-93	Phillips-Recess Blade PH000	○
4-380-94	Phillips-Recess blade PH0000	●



4-380-PH



BERNSTEIN
TOOLS FOR ELECTRONICS

WINNER

SPANNFIX 4.0 – THE ALLROUNDER

You can find all information about our clamping tools
in the BALL JOINT - VICES BALL JOINT -
HOLDER AND EQUIPMENT brochure



WRENCH KEYS

▶ Allen wrench keys hex (VE10)

Material tool steel, surface nickel-plated
manufactured according to DIN ISO 2936 (DIN 911)

Art.-No.	Symbol	WAF inch	WAF	Leg length A	Leg length B	Weight g/pcs
6-812	⬢	—	1,0	32	10	0,2
6-813	⬢	—	1,5	45	14	1,0
6-814	⬢	5/64	2,0	50	16	2,0
6-815	⬢	—	2,5	56	18	3,0
6-816	⬢	—	3,0	63	20	5,0
6-817	⬢	9/64	3,5	66	22	7,0
6-818	⬢	5/32	4,0	70	25	10
6-819	⬢	—	4,5	75	26	13
6-821	⬢	—	5,0	80	28	18
6-822	⬢	7/32	5,5	85	30	24
6-823	⬢	—	6,0	90	32	30
6-825	⬢	9/32	7,0	95	34	43
6-826	⬢	5/16	8,0	100	36	60
6-827	⬢	11/32	9,0	105	38	76
6-828	⬢	—	10,0	112	40	103
6-851	⬢	3/64	1,2	40	12	0,4
6-852	⬢	1/16	1,59	45	14	1,0
6-854	⬢	3/32	2,38	56	18	3,0
6-855	⬢	1/8	3,18	63	20	5,0
6-858	⬢	3/16	4,76	80	28	16
6-861	⬢	1/4	6,35	90	32	30
6-865	⬢	3/8	9,53	112	40	103

▶ 6-820 ⬢

Wrench key set 8 pcs

Contents: 1.5 - 2.0 - 2.5 - 3.0 - 4.0 - 5.0 - 5.5 - 6.0 mm
manufactured according to DIN ISO 2936 (DIN 911)
Material tool steel nickel-plated, in plastic bag
Weight: 90 g

▶ 6-950 ⬢

Ballpoint wrench key set 9 pcs

Contents: 1.5 - 2.0 - 2.5 - 3.0 - 4.0 - 5.0 - 6.0 - 8.0 - 10.0 mm
manufactured according to DIN ISO 2936 (DIN 911)
Material tool steel nickel-plated, in plastic holder
Weight: 380 g

▶ 6-995 ⚙

TORX wrench key set with hole 8 pcs

Content: TORX T9 - T10 - T15 - T20 - T25 - T27 - T30 - T40 with hole
manufactured according to DIN ISO 2936 (DIN 911)
Material tool steel burnished, in plastic bag
Weight: 120 g



6-820



6-950



6-995

SOCKET WRENCHES

▶ 4-775

Plastic spring handle for socket wrenches 6-200

Material orange transparent plastic, weight 30 g



▶ 6-200







Socket wrench 8 pcs

Inhalt siehe Artikelaufistung Tabelle

Industrienorm, Klingenlänge 140 mm, lingen Ø 6 mm

Material Chrom-Vanadium-Molybdän Stahl HRC 56-58, vernickelt

inklusive 4-775 Kunststoff-Griff in praktischer Rolltasche, Gewicht 310 g

Art.-No	Symbol	Size / drive	Blade length	Blade diameter	Total length	Weight in g
6-201		4.0	140	6	140	30
6-202		5.5	140	6	140	35
6-203		6.0	140	6	140	35
6-204		7.0	140	6	140	40
6-205		8.0	140	6	140	40
6-206		9.0	140	6	140	43
6-207		10	140	6	140	45



▶ Adjustable spanners / adjustable wrenches

Material chrome vanadium molybdenum steel HRC 56-58, surface nickel-plated

Art.-No.	Span width	Jaw length	Total length	Weight in g
6-771	0 - 13	12	100	55
6-772	0 - 19	22	150	135



▶ 6-320

Socket wrench set 36 pcs with ratchet + extension

Sheet steel case with foam inlay, content:

1/4 inch hex sockets 4.0 - 4.5 - 5.0 - 5.5 - 6.0 - 6.5 - 7.0 - 8.0 - 9.0 - 10 - 11 - 12 - 13

1/4 inch PH screwdriver PH1-PH2

1/4 inch screwdriver 4.0 - 4.5

1/4 inch Allen key 3.0 - 4.0 - 5.0 - 6.0

1/4 inch TX screwdriver TX20 - TX25 - TX27 - TX30

1/4 inch cardan joint

1/4 inch extension 50 and 100 mm

1/4 inch handle with slide

1/4 inch plug-in handle with square drive

1/4 inch lever ratchet 72 teeth 140 mm

Allen wrench 1.25 - 1.5 - 2.0 - 2.5 - 3.0

weight 1320 g



OPEN-END WRENCHES AND RING SPANNERS

► 6-750

Special double open-end wrench set 6 pcs

small sizes for filigree work, very narrow for hard to reach places

Open-end spanner size: 3.0 - 6.5 mm length 120 mm and material thickness 1.5 mm

Open-end spanner size: 7.0 - 10 mm length 125 mm and material thickness 2.0 mm

Material tool steel, surface nickel-plated

in plastic roll bag, weight 100 g

Set consisting of:

6-750-3 open-end spanner 3 x 3.5 mm

6-750-4 Open-end spanner 4 x 4.5 mm

6-750-5 Open-end spanner 5 x 5.5 mm

6-750-6 Open-end spanner 6 x 6.5 mm

6-750-7 Open-end spanner 7 x 8 mm

6-750-9 Open-end spanner 9 x 10 mm



► 6-750-13

NEW

ESD Special double open-end wrench set 6 pcs

same set as above with ESD coating

dissipative between 10^6 and 10^9 Ohm

weight 104 g

IMPORTANT: During use, put an ESD protective cap (included) on the free back side. That no leakage current can flow under the ESD coating.



► 6-500

Double open-end wrench set 8 pcs

content: 6x7 - 8x9 - 10x11 - 12x13 - 14x15 - 16x17 - 18x19 - 20x22 mm

Industrial quality according to DIN 3110

heads polished, material chrome-vanadium steel, surface chrome plated

transparent packaging with a practical storage holder, weight 700 g



► 6-600

Combination wrench set 12 pcs

content: 6-7-8-9-10-11-12-13-14-17-19-22 mm

Industrial quality according to DIN 3113

heads polished, material chrome-vanadium steel, surface chrome plated,

transparent packaging, with a practical storage holder, weight 850 g

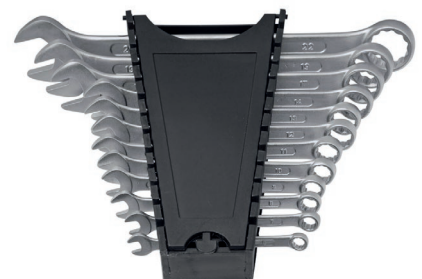

TERMS OF SALE AND DELIVERY

GENERAL

The nature and scope of delivery are specified in the order confirmation. The following delivery terms shall apply to all deliveries to be carried out by us. Purchasing conditions of the customer do not oblige us, even if we do not expressly contradict this. Verbal or by intercom agreements made require our written confirmation. Obvious mistakes in offers, order confirmations, etc. are expressly reserved and can be considered at any time. We are entitled to process any data relating to the business relationship or in connection with the same concerning buyers, whether the buyer itself or third parties, within the framework of the Federal Data Protection Act.

OFFER

Our offers are permissive, an order is deemed to be granted if confirmed by us in writing. PRICES, DELIVERY BASIS AND PACKAGING Unless otherwise agreed, the prices in Euros, ex works, are exclusive packaging. In the case of special packaging regulations of the customer, the additional costs involved are invoiced. Packaging is not accepted.

DELIVERY

The delivery takes place at the expense and risk of the buyer without regard to who bears the freight costs. We reserve the right to place orders in partial deliveries. For custom-made products, excess or short deliveries of up to 10% are permitted.

DELIVERY TIME

The delivery time begins upon receipt of all information required for the execution of the order. We endeavor to comply with the delivery time specified in the order confirmation. No claims of any kind can be asserted from a delayed delivery.

COMPLAINTS

Complaints can only be accepted within 8 days after receiving of the goods.

The shape and colour of the tool may differ from the item shown in the catalogue.

GUARANTEE

For all BERNSTEIN tools, which are unusable due to proven material or manufacturing defects, we deliver within one year after deliver a replacement. This free replacement service is excluded if the tools have become unusable due to natural wear or improper handling.

DISCLAIMER

We do not assume any guarantee for the suitability of our products for the intended purpose of the customer. For damages caused by unsuitable or improper use, commissioning by the customer or third parties, and for the natural wear and tear we assume no guarantee. Any claims for damages, irrespective of the legal basis, as well as, in particular, the liability by tort (product liability) are excluded to the extent permitted by law.

PAYMENT

Our invoices are payable within 10 days of the invoice date with 2% discount or in 30 days net, unless otherwise agreed in the order confirmation.

RESERVATION OF TITLE

We reserve the title to all goods delivered by us until the buyer has paid all claims arising from the business relationship. The buyer is entitled to resell the reserved goods in ordinary business transactions. In the case of resale, the buyer has to reserve the ownership of the sold goods on the same terms as his customer. The purchaser hereby assigns to us the purchase price claim against the buyer from the resale.

FULFILLMENT AND JURISDICTION

Place of performance and jurisdiction for delivery and payment is Remscheid. In any case, only German law shall apply, with the exclusion of any foreign law.

ONLINE DISPUTE RESOLUTION

The European Commission provides a platform for online dispute resolutions (ODR) which can be accessed at

<https://ec.europa.eu/consumers/odr/> .

In order to settle dispute arising from a contractual relationship with a consumer or from whether such a contractual relationship exists at all, we will participate in dispute settlement proceedings before a consumer dispute resolution body. Consumers can contact their national European Consumer Centre in this regard. The respective contact details of the individual ECCs can be found at

<https://www.evz.de/en/alternative-dispute-resolution/adr-in-europe/>.



A little story about
the word amber (BERNSTEIN)

The greek word for amber is „elektron“: the root of today's term electronics. Even the greeks discovered the special feature of amber: by rubbing the natural amber can be electrostatically charged. The charged stone can attract dust particles.

Today you can use this property to check the authenticity of an amber. If it is real, it can be tested through charge rubbing on a cotton cloth.

You can also wear it as jewellery:
it should protect from evil magic and give joy of life.

Just like our high-quality BERNSTEIN
ESD Tools - them protect against
electrostatics and give joy with
the daily work.

(Autor Max Walter Hartmut Blombach)

BERNSTEIN

**Werkzeugfabrik
Steinrücke GmbH**

Industriehof Trecknase 1
42897 Remscheid

Tel. + 49 (0) 2191 - 9650 - 0
Fax + 49 (0) 2191 - 9650 - 30

sales@bernstein-tools.de
www.bernstein-tools.de

X-ON Electronics

Largest Supplier of Electrical and Electronic Components

Click to view similar products for [Screwdrivers, Nut Drivers & Socket Drivers](#) category:

Click to view products by [Bernstein](#) manufacturer:

Other Similar products are found below :

[1406504-2](#) [272012M](#) [271001M](#) [30246](#) [HMM-HH](#) [32024](#) [TL10416](#) [612020B](#) [35-045](#) [6951](#) [83](#) [9977](#) [EMF](#) [99833](#) [RB1](#) [S3166V](#) [X103V](#)
[XTD10TP](#) [X108N](#) [HS7N](#) [HS618N](#) [LN25MMN](#) [HS18N](#) [XST1010N](#) [P4N](#) [R146N](#) [P12SN](#) [R5324N](#) [99764N](#) [P8N](#) [99312N](#) [R3163N](#)
[SX101N](#) [LN22N](#) [XTD10N](#) [9955MMN](#) [995MMN](#) [996MMN](#) [LN25N](#) [THS9N](#) [R3166N](#) [R144N](#) [RB2N](#) [HS10N](#) [99964BPN](#) [HS11N](#) [HS12N](#)
[THS8N](#) [TL12N](#) [LN23BPN](#)