

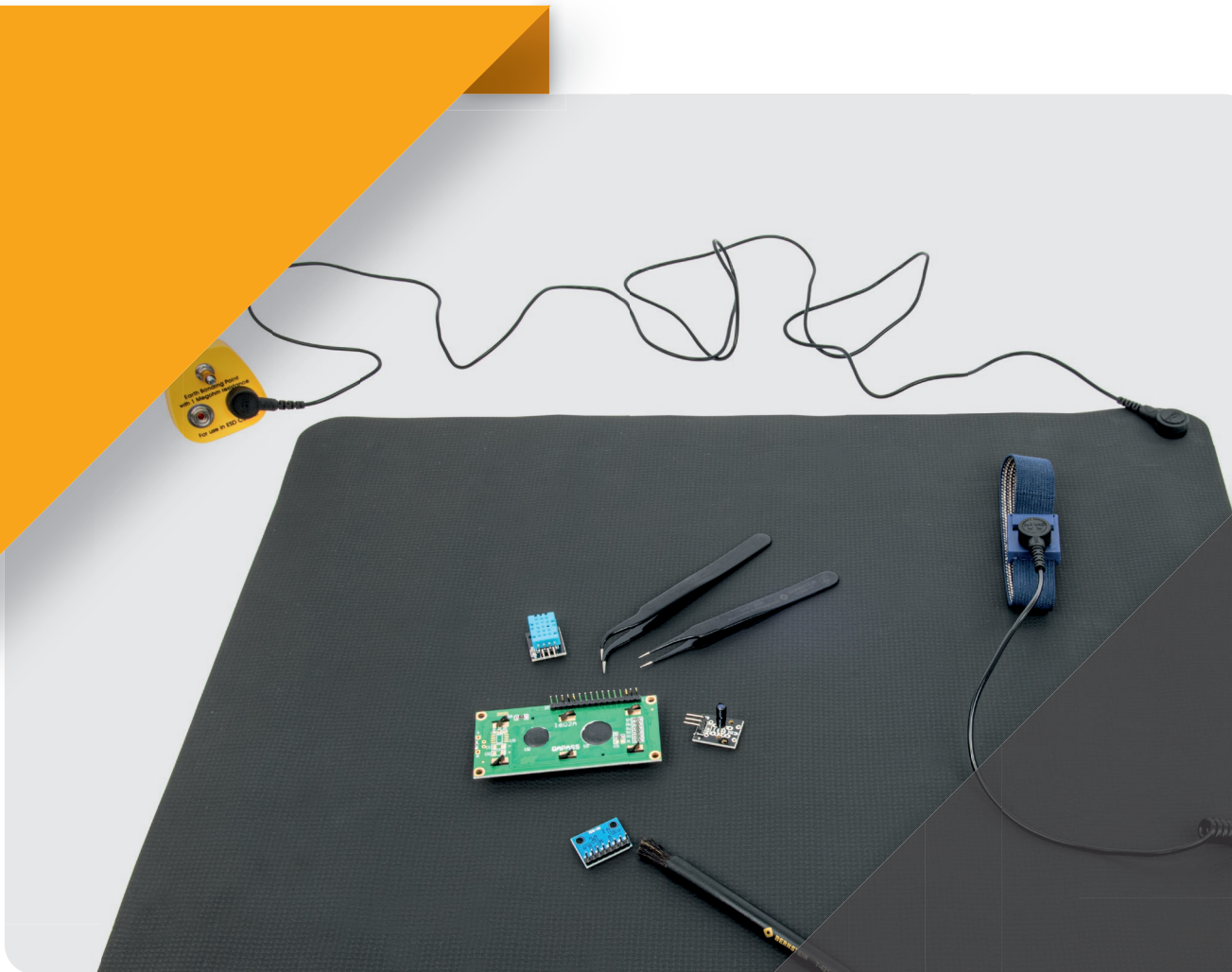

BERNSTEIN
TOOLS FOR ELECTRONICS



**ESD WORKSTATION
ESD HAND TOOLS
+ USEFUL HELPERS**

Vers.01

GET IN CONTACT WITH US**BERNSTEIN****Werkzeugfabrik
Steinrücke GmbH**

Industriehof Trecknase 1
42897 Remscheid

Tel. + 49 (0) 2191 - 9650 - 0
Fax + 49 (0) 2191 - 9650 - 30

sales@bernstein-tools.de

VISIT US ON THE WEB

We update our product information on a regular basis and automatically using our Product Information System. This enables the quick and up-to-date compilation of customer-specific data feeds for your own digital sale activities. Take advantage of this service and always keep Bernstein product information up to date!

www.bernstein-tools.de

Product videos and blog posts round off our online offering. Furthermore, we also respect the traditional sales channel via specialist retailers and offer the option to present your webshop as an online sales platform for products by BERNSTEIN.

SYMBOL LEGEND**NEU**

New product



Number of tools in sets



Weight



Dimensions



ESD protection (EPA suitable)



VDE tested

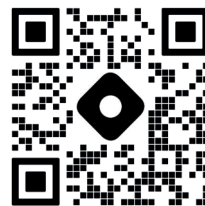



ESD WORKSTATION ESD HAND TOOLS + USEFUL HELPERS

On the following pages we start with the specialized topic „ESD - the invisible danger“ a clear manual on the subject of ESD and safety at the workplace. Here you will find information on discharge resistances, symbol explanations, notes and tips on setting up an ESD workplace. Available on our website as PDF download: **ESD - GUIDE 2020 - WHAT IS ESD?**

Pay attention to the **HANDLING SETS** with grounding mats, these are completely assembled sets to make your choice easier. Then we would like to draw your attention to our **new ESD tool holders**, which create order at every workplace. A clean and tidy work area is efficient and your tools will thank you with a long service life.

Furthermore, we offer various products and endowment of a well-prepared and safe workplace.

Here you will find ESD and NOT ESD hand tools, please pay attention to the ESD symbol if necessary.



ESD – THE INVISIBLE DANGER

WHAT DOES ESD MEAN?

ESD stands for electrostatic discharge. It is caused by the sudden equalisation of charge between objects with a different charge potential. This discharge can generate a large amount of electrical current.

HOW IS ELECTROSTATIC CHARGE GENERATED?

Every object has positive and negative elementary particles. Positive and negative charges normally neutralise each other. Objects are electrically neutral. However, if an object loses electrons, an imbalance arises.

This imbalance is called the charge potential. Charged objects have a tendency to equalise by discharging. In the event of a sudden discharge, high currents flow in a small electronic component.

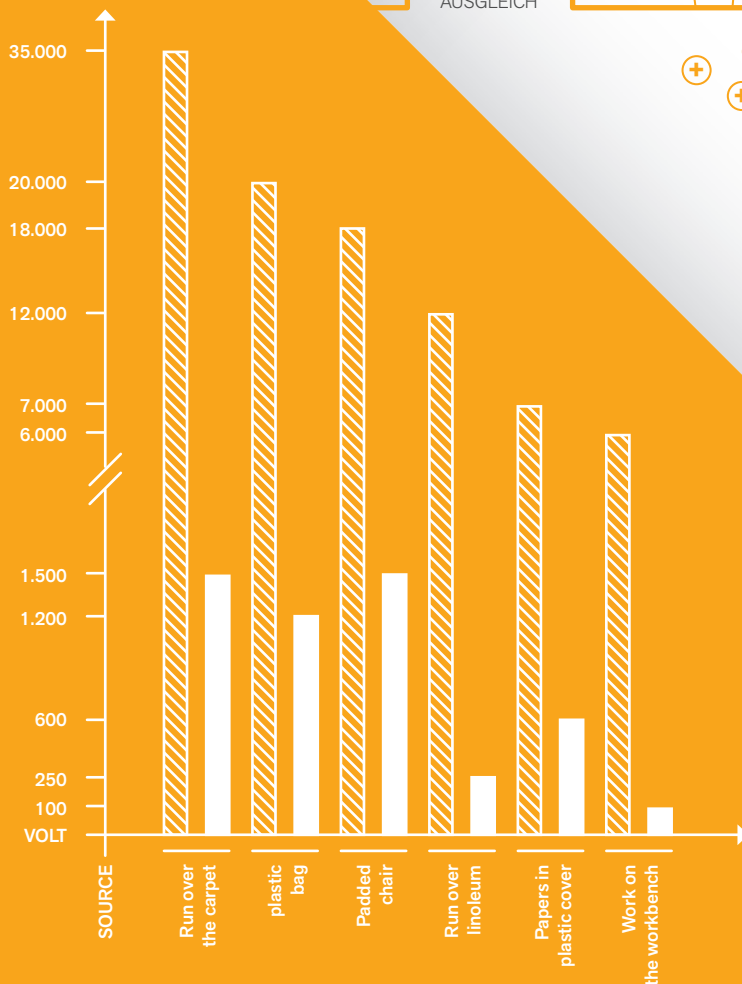

ELECTROSTATIC CHARGE AND THEIR POSSIBLE CAUSE

air humidity 10-20%
 air humidity 65-90%

ELECTROSTATIC DISCHARGE IN EVERYDAY LIFE

The most visible form of electrostatic discharge is lightning during a storm, when clouds with different potentials abruptly discharge. All of us have at one point experienced a sudden discharge, such as after walking across a carpeted floor and then touching the handle of a door.



FOLLOWS ELECTROSTATIC UNLOADING OF COMPONENTS

Date of damage detection	value	efforts
component level	1x	part costs production stop
assembled circuit board	10x	part costs production stop error search repair costs
finished, tested product	100x	part costs production stop error search repair costs inspection costs delivery delays
delivered product	1000x	Replacement/repair costs Field service / delivery costs compensation loss of reputation

COMPONENT SENSITIVITY

The ESD sensitivity of electronic components is rising as component parts are increasingly miniaturised. Moreover, ever smaller components offer less and less space for protective circuits on microchips. In order to save energy, components need to get by on less power. A discharge of just 50 volts is enough to cause damage to a blue LED, for example. SMDs are already at risk of damage at voltages higher than 100 V. In contrast to this, the human ability to perceive ESD is very limited. Discharges are first noticeable from 3500 volts, audible from 4500 volts and visible from 10000 volts.

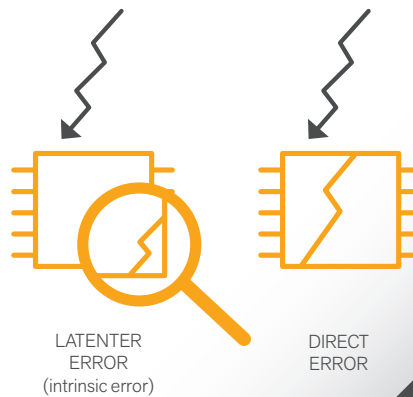

DETECTING AND ELIMINATING FAULTS

Components damaged by ESD cannot normally be seen with the naked eye. Even tiny discharges can lead to complete failure. These direct failures can usually be identified during quality control. So-called latent failures are especially critical, as they only become apparent when products are in operation. The time and effort needed to eliminate these intrinsic failures cause the greatest costs. ESD damage generally concerns latent damage. It is therefore absolutely essential that the appropriate precautions are taken.

FAILURE CAUSE ELECTRONICAL COMPONENTS

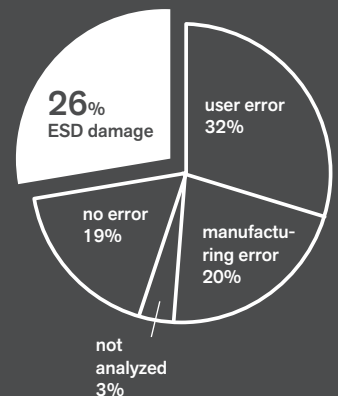



ESD – HOW TO PROTECT YOURSELF AND YOUR COMPONENTS

HOW CAN YOU PROTECT COMPONENTS?

You can protect ESD-sensitive components by storing, handling and packing them in a completely ESD protected environment. Precautionary measures are taken in these areas to eliminate electrostatic build-up. The difference in potential is neutralised by slowly dissipating the charge, thereby preventing a sudden discharge. This abrupt release constitutes the real danger. A very short and rapid discharge generates a very high discharge current.

MARKINGS AND SYMBOLS

It is important to identify ESD-sensitive components, ESD-safe working areas and ESD-safe objects. Safe objects are identified by a black triangle on a yellow background with a stylised hand surrounded by a circular arc. In addition, the acronym EPA (ESD protected area) is added for ESD protected areas. For ESD-sensitive components, there is no black circular arc and there is a line running through the hand to indicate ESD-sensitive products. It also makes sense to use ESD inspection tags which display the date when the object was last inspected for protective effectiveness.



ESD GROUNDING POINT

marked
grounding point for
all ESD
components

SYMBOLS AND YOUR MEANING



ESD SAFED

marked
ESD safe
tools and objects



ESD DANGERED

marked
endangered
components and
domains



ESD protected area

marked
ESD protected
area

WHAT DOES THE NORM SAY?

DIN - EN 61340-5-1/VDE 0300, Part 5-1 „Protection of electronic devices from electrostatic phenomena“ General requirements; DIN - EN 61340-5-2 / VDE 0300, Part 5-2 „Protection of electronic devices from electrostatic phenomena“, User guide; DIN - EN 61340-2-1 / VDE 0300, Part 2-1 „Measurement methods – Ability of materials and products to dissipate static electric charge“; DIN - EN 61340-4-1 / VDE 0300, Part 4-1 „Standard test methods for specific applications – Electrical resistance of floor coverings and installed floors“; DIN - EN 61340-4-3/VDE 0300, Part 4-3 „Standard test methods for specific applications – Footwear“; DIN - EN 61340-4-5/VDE 0300, Part 4-5 „Standard test methods for specific applications – Methods for characterizing the electrostatic protection of footwear and flooring in combination with a person“.

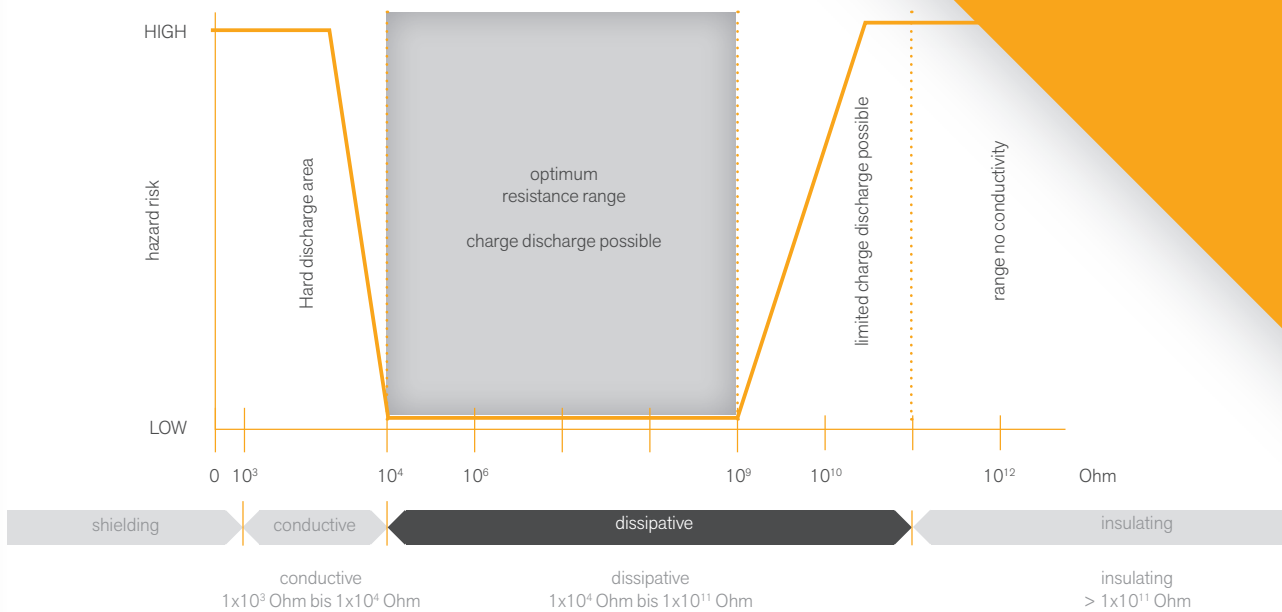

SURFACE RESISTANCES

The effectiveness of materials is classified according to their resistance properties. Here, surface resistance plays a particularly important role: it is the electrical resistance of a conductive layer on the surface. Depending on the resistance properties, a distinction is made between shielding materials, electrically conductive materials, electrically dissipative materials and insulating materials.

MEASUREMENT OF RESISTANCES IN THE ESD AREA

In addition to surface resistance, the following resistances are also important: the bleeder resistance (resistance against earth/protective conductor), volume resistance (resistance measured at opposite points of a material) and point-to-point resistance (resistance between two electrodes).

PERSONS AND WORKPLACES EQUIPMENT

If ESD-sensitive components are being handled, people and workplace equipment need to be ESD compliant. The primary focus for people is ESD-compliant clothing (shoes, coats, antistatic wrist straps), for workplace equipment, conductive flooring is just as important as ESD-compliant workbenches and chairs. The most important measure is the proper grounding of personnel.

ESD COMPLIANT TOOL

ESD-compliant tools are also just as important. In the Bernstein catalogue, you will find a comprehensive range of ESD-compliant tools for use in ESD protected areas. Often work needs to be performed outside of these protected areas, in which ESD-sensitive components need to be installed. We offer solutions here too, which are suitable for mobile use, such as table covers, grounding plugs for power sockets, clamping equipment and hand tools.

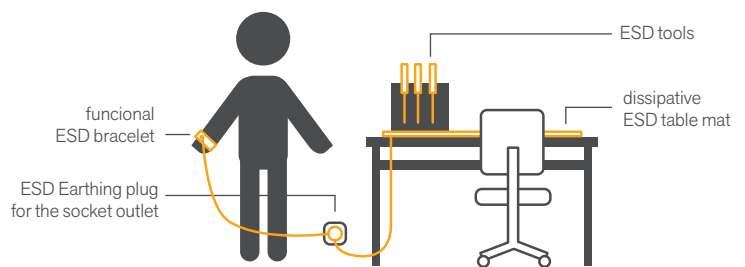

Simple design of an ESD-safe workstation for mobile use

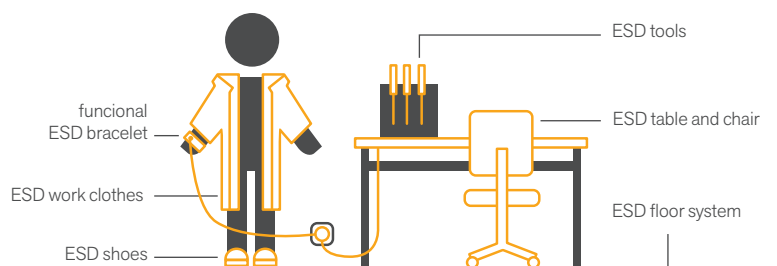

ESD-safe execution of a work schedule in the EPA area



HOW YOU SET UP YOUR WORKPLACE IN A ESD-SECURE WAY

STATIONARY WORKPLACE - WORK IN THE EPA AREA

An ESD-safe workplace is indispensable in order to safely and properly carry out work and measurements on electrostatically sensitive components.

In fixed installations, such as in EPAs (electrostatic discharge protected areas), all elements that come into contact with people and components should be electrostatically conductive.

Foot mats, workplace pads, large assemblies and personnel grounding are earthed by so-called earth bonding plugs, while it is important to pay attention to ESD logos for clothing and tools.

MOBILE WORKPLACE - WORK ON THE ROAD

It doesn't happen often that fully assembled components or assemblies can be handled, repaired or serviced in ESD protected areas. This is where so-called ESD workplaces are needed.

The traditional mobile workplace (also called a handling set) consists of a workplace pad, a wrist band for grounding of personnel and an earthing cable with a earthing plug.

If there are no plug sockets available, the earthing cable can also be attached to grounded metal surfaces using a crocodile clip.

When properly set up, static electricity is discharged via the mat. But when using this method, it is important to make sure that the hand-to-earth resistance is less than 3.5×10^7 ohms.

MAINTENANCE AND CLEANING

Grounding connections, mats and earthing plugs should be inspected on a weekly basis and wrist bands every day.

Special cleaning agent must be used when cleaning them as conventional household products may leave behind an insulating coating.



CORRECT STRUCTURE OF THE COMPONENTS ON MOBILE WORKPLACE

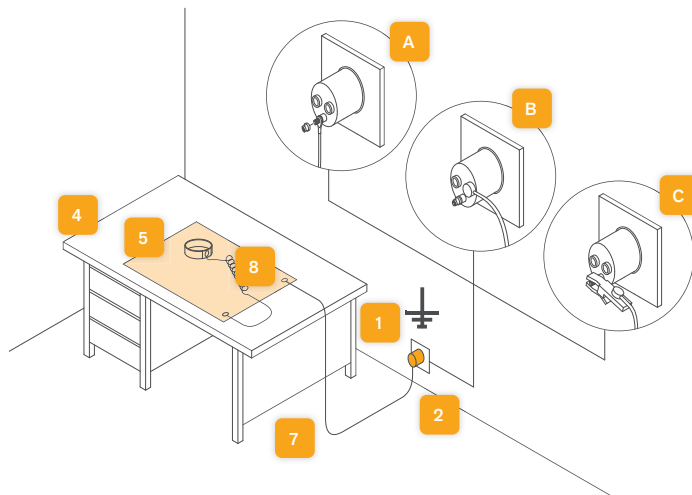

CORRECT STRUCTURE OF THE COMPONENTS ON STATIONARY WORKPLACE

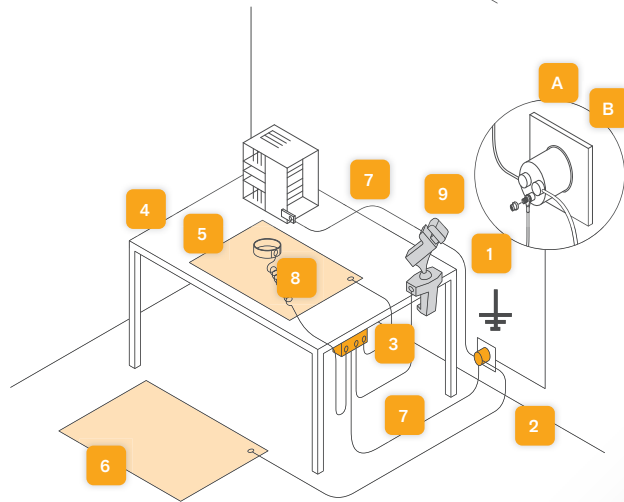

Explanations to the graphics:

BESTANDTEILE PASSENDE PRODUKTE VON BERNSTEIN

BESTANDTEILE	PASSENDE PRODUKTE VON BERNSTEIN
1	grounding point —
2	earthing 9-359-2 (for EU sockets) 9-353 (for clamping on metal)
3	earthing module 9-359-1 (for clamping on table)
4	workplace —
5	working mat 9-354-100, 9-360-0, 9-361-0, 9-367-0, 2291, 2301, 9-334
6	floor mat 9-361-0, 9-367-0
7	earthing cables 9-343-1, 9-344-1
8	personal ground- ing/bracelet 9-341, 9-342
9	Components and devices 9-205 ESD more page 36

Our workplace requirements can also be used as shelf supports

EARTH VARIANTS AT THE EARTH PLUG

- A by thread
- B by button
- C by clip

On the following pages you will find an overview and more detailed information on suitable products.



ESD GROUNDING MATS



In order to be able to carry out work and measurements on electrostatically sensitive components safely and correctly, an ESD safe workplace is essential.

All mats are EPA suitable, for working in electrostatically protected areas (ESD workplace/ ESD protection zone).

▶ 9-354-100 ESD table mat 500 x 400 x 0.5 mm with 2 press buttons

Weight: 130 g

Dissipative 10^8 Ohm, surface resistance according to DIN IEC 61340-4-1

with 2 x 10 mm press buttons, for connection to an earthing plug, ideal for service work and mobile use



▶ 9-366-0 ESD table mat black 610 x 450 x 1.5 mm

Weight: 640 g

▶ 9-360-0 ESD table mat black 900 x 610 x 1.5 mm

Weight: 1000 g

Technical data: Abrasion (load: 5N) 130 mm³, hardness 80 Shore A, impression test 0.1 mm, temperature range of application - up to + 60 °C, ESD mat suitable for table, shelf or floor resistance 10^6 to 10^7 ohm (back side 10^3 to 10^4 ohm), top and back side black electrostatically synthetic rubber, with 2 press buttons 10 mm for ground connection, solder resistant, extremely wear-resistant, permanently elastic, halogen free



▶ 9-367-0 ESD table mat grey 610 x 450 x 2 mm

Weight: 700 g

▶ 9-361-0 ESD table mat grey 900 x 610 x 2 mm

Weight: 1400 g

Technical data: Abrasion (load: 5N) 130 mm³, hardness 78 Shore A, impression test 0.1 mm, light reflectance 19% - 29%, temperature range of application - up to + 60 °C, resistance 10^6 to 10^7 ohm (back side 10^3 to 10^4 ohm), Platinum gray on top, black back of electrostatically dissipative synthetic rubber, with 2 press buttons 10 mm for ground connection, solder-resistant workplace support, heat resistant, abrasion resistant, scratch proof, extremely wear-resistant, permanently elastic, halogen free



HANDLING SETS WITH ESD GROUNDING MATS

Grounding mat Size	9-354-0 500 x 400 mm		9-366-0 610 x 450 mm		9-360-0 900 x 610 mm		9-361-0 900 x 610 mm		9-367-0 610 x 450 mm	
Thickness	0.5 mm		1.5 mm		1.5 mm		2.0 mm		2.0 mm	
+ SET bracet + spiral cord	9-342 (blue)	9-341 (yellow)	9-342 (blue)	9-341 (yellow)	9-342 (blue)	9-341 (yellow)	9-342 (blue)	9-341 (yellow)	-	
+ Grounding cable	9-343-1	9-344-1	9-343-1	9-344-1	9-343-1	9-344-1	9-343-1	9-344-1	-	
+ Crocodile clip	9-353	-	9-353	-	9-353	-	9-353	-	-	
+ Grounding plug / Earth bonding point	-	9-359-2	-	9-359-2	-	9-359-2	-	9-359-1 9-359-2	9-359-2 9-343-1	
= SET Item No.	9-354	9-354-A	9-366	9-366-A	9-360	9-360-A	9-361	9-361-A	9-367	

ESD MOBILE WORKING MAPS



► 2301

ESD dissipative workplace pad with 20 tool loops

Dissipative workplace pad with 20 tool loops for various uses.

The foldable tool folder made from ESD material also serves as an electrically dissipative workplace pad and, when unfolded, is 680 x 660 x 35 mm. The bleeder resistance is approx. 10^8 ohms in accordance with DIN 53482. **The workplace pad is equipped with three press studs for connecting a contact wrist band and an earthing cable.** The tool folder can be closed with two additional press studs and used as a tool wallet. The large support surface (660 x 435 mm) offers enough space to handle sensitive electronic components safely. For transport, the bag can be quickly folded to a handy size.

Locating surface: 660 x 435 mm

Weight: 525 g



► 2291

ESD dissipative workplace pad with 22 tool loops

A foldable tool bag with integrated work surface for various ESD applications. Handy tool flap pocket made of dissipative synthetic leather. The bag has a total of 22 rubber loops for holding tools and other parts. Thanks to the new design, the tool area can be set up with a Velcro loop, which significantly improves access to the tools. **The bag has two press studs that can be connected to a wrist strap and an earthing cable (included), which allows each workstation to be converted to an ESD workstation.** The large support surface (480 x 340 mm) offers enough space to safely handle sensitive electronic components. For transport, the bag can be quickly folded to a handy size and closed with a rubber band.

Locating surface: 480 x 340 mm

Weight: 480 g



► 9-334

ESD assembly grid mat

material natural rubber, electrically conductive 10^3 bis 10^4 Ohm
tough mat as a stress-relieving tray, for SMD repairs
printed circuit boards (PCBs) or devices

Dimension 610 x 370 x 20 (cell size 50 x 45 mm)

Weight: 3200 g

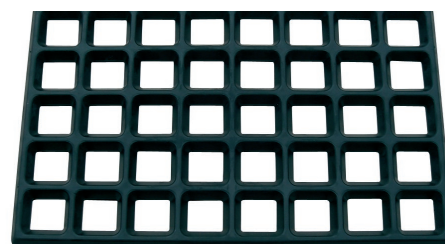

GROUNDING-, EARTH BONDING POINT



EPA suitable. For working in electrostatically protected areas (ESD workplace / ESD protection zone).

▶ 9-359-1

ESD earth bonding plug 3 x 10 mm with cable and eyelet

- EPB earth bonding point
 - for table screw connection, angled (incl. 2 screws)
 - as a ground connection point for personal grounding
 - cable length 2 m with 4 mm loop
 - 3 x 1 megaohm safety resistance, 10 mm press buttons
- Weight: 45 g



▶ 9-359-2

ESD earth bonding plug 2 x 1 MOhm and M5 connection

- EPB earth bonding point
 - Earthing plug with cable for EU sockets
 - as a ground connection point for personal grounding
 - ESD earth bonding plug 2 x 1 megaohm and M5 connection, 10 mm press buttons
 - 1x screw connection M5 for 4 mm eyelet
 - suitable cable: 9-343-1, 9-344-1
- Weight: 33 g



▶ 9-353

ESD crocodile clip 1 x 10 mm

- with banana plug socket, 10mm press button
 - press buttons 10 mm
- Weight: 18 g



▶ 9-343-1

ESD grounding cable 2 x 10 mm connection

- for connection between table and floor coverings and for connection to an earth potential.
 - with 1 megaohm safety resistance
 - 2 press buttons 10 mm for mats or floor connection
 - cable length 1.8 m
- Weight: 40 g



▶ 9-344-1

ESD grounding cable 1 x 10 mm with eyelet 4 mm

- for connection between table and floor coverings and for connection to an earth potential
 - with 1 megaohm safety resistance
 - 1 flat press button 10 mm for mats or floor connection
 - 1 eyelet for M5 thread at the socket ground
 - cable length 1.8 m
- Weight: 40 g



▶ SETS



9-205-ESD-SET1

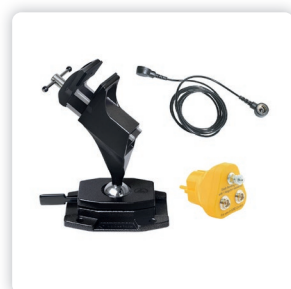

9-215-ESD-SET1



9-251-ESD-SET1



9-261-ESD-SET1

CONTACT BRACELET, CABLE AND SETS



Wrist grounding, as a safe method to derive electrostatic charge from people, consists of an adjustable wrist strap with woven silver-plated synthetic fibers (close skin contact necessary) and a spiral cable which connects the wristband with the earthing point via press buttons, electrically dissipative.

The coiled cable has a safety resistance of 1 MOhm on each connection side and is approved for workplaces with a rated voltage up to 250 VAC. To ensure adequate insulation, the bracelet may only be stored in a dry place.

► 9-341-1 (yellow)

9-342-1 (blue)

ESD contact bracelet

- EPA suitable. For working in electrostatically protected areas (ESD workplace / ESD protection zone)
- meets the safety requirements for wrist grounding standard
- fit for 3-4 mm press button
- adjustable, anti-allergic, washable
- belt length 220 mm
- Weight: 9 g



► 9-341-2 (yellow)

9-342-2 (blue)

ESD highly elastic spiral cord for bracelet 2.4 m

- EPA suitable. For working in electrostatically protected areas
- 2 x 1 megaohm safety resistance
- 3 mm press button for wrist strap
- 10 mm press button for ground connection
- length 2.4 m
- Weight: 25 g



► 9-342 / 9-341

ESD contact bracelet with spiral cord and crocodile clip

- EPA suitable. For working in electrostatically protected areas (ESD workplace / ESD protection zone)
- bracelet adjustable, anti-allergic, washable
- belt length 220 mm
- press buttons 3-4 mm for wrist strap and 10 mm for ground contact connection
- highly elastic 2.4 m long spiral cable
- 2 x 1 megohm safety resistor
- insulated crocodile clip for grounding with clamp connection
- Weight: 60 g



Further sets:

Art.-No. set	9-341	9-342	9-343	9-343-A	9-350
bracelet	9-341-1 (yellow)	9-342-1 (blue)	—		9-342-1 (blue)
cable	9-341-2	9-342-2	9-343-1		9-342-2
crocodile clip	—	9-353	9-353	9-343-1	9-343-1
grounding plug				9-359-2	
crocodile clip	—	9-353	9-353		9-353



TOOL HOLDER STOREY

NEW



For more organisation at your workstation

The STOREY tool holder was developed as practical storage for hand tools so that your tools are always within reach. Whether as a table stand or wall holder.

Holder made of 1.5 mm sheet steel
ESD powder coated RAL9005
dissipative 10^5 - 10^9 Ohm
100% Made in Germany



Approx. 125 x 55 x 70 mm
(dimensions for guidance)

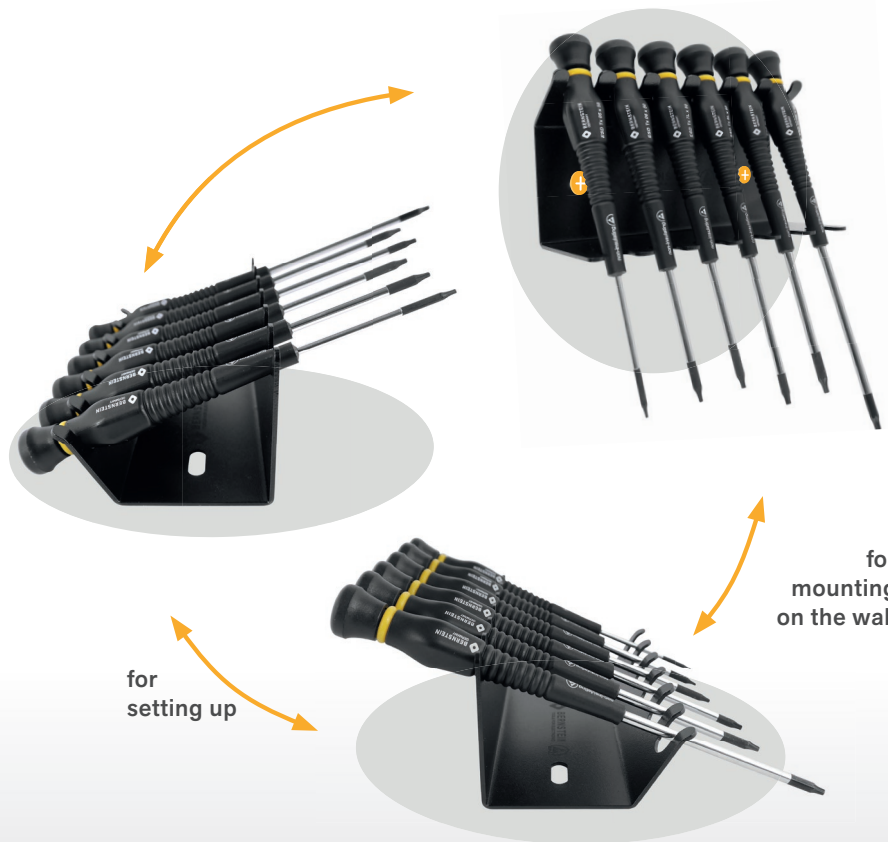

for
setting up

for
mounting
on the wall

► 4-600-0

ESD Werkzeughalter STOREY (ohne Werkzeuge)

Our BERNSTEIN STOREY as a conductive steel tool holder is often used in the EPA area, where uncontrolled discharge of tools or objects must be avoided. (EPA suitable for work in electrostatically protected areas: ESD workstation / ESD protection zone / EPA electrostatically protected area).

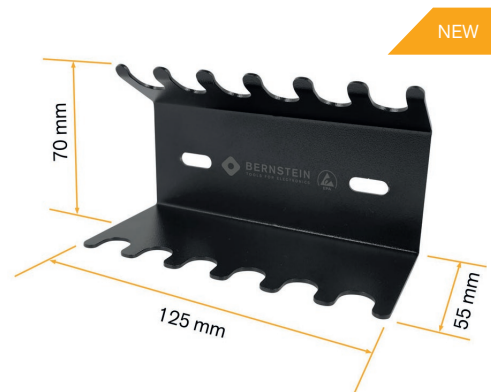

NEW

► 5-090-0

ESD tool holder VARIO tronics (without tools)

For more tidiness in the workplace!

The practical VARIO tronics tool holder is made of sturdy 1.5 mm sheet steel and has a high-quality, dissipative black powder coating. In addition to pliers and tweezers, it can also store our handy screwdrivers or round objects with a maximum diameter of 9 mm. The recess in the lower area allows the blades or tips of the tools to be quickly identified and selected. The locking aid at the rear edge additionally helps to hold each tool in position. Small noses on the upper edge of the suspension rail prevent pliers or tweezers from slipping down. The tool holder can be placed on a surface as well as hung. Two holes on the rear side allow easy mounting to the wall.

Weight: 400 g

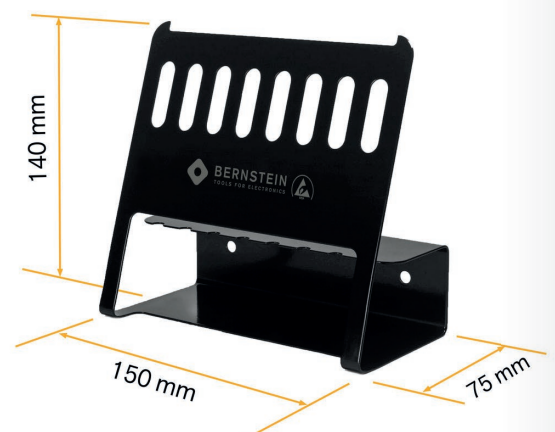

TOOL HOLDER VARIO



140 mm wide rail for hanging pliers and tweezers



8 slotted holes for inserting tools up to a diameter of 9 mm



Approx. 150 x 140 x 75 mm (dimensions for guidance)



5-090-0
VARIOtronic

Locking aids for a secure hold of the tools

Screw holes (Ø 6mm) for mounting on the wall

PRIVATE LABEL
on request with logo print

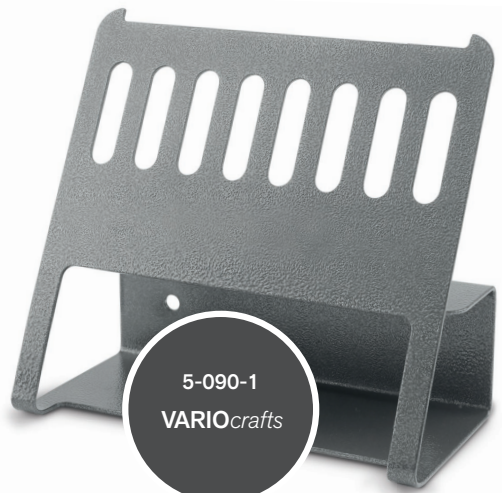

5-090-1
VARIOcrafts

Art.-No.	Content
5-090-0	VARIOtronic, dissipative (10 ⁶ - 10 ⁹ Ohm)
5-090-1	VARIOcrafts, dark grey metallic

Under the search term **VARIO** you will find all information about the tool holder and other sets on our website.

TOOL HOLDER SQUARE

NEW

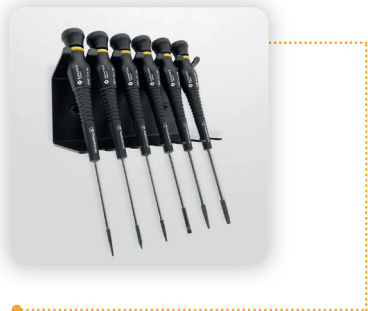

The versatile tool stand SQUARE is made of 2.0 mm extremely sturdy sheet steel and has a high-quality ESD dissipative black powder coating. Besides pliers, tweezers and screwdrivers, many other hand tools can be stored. Based on the square recess, blades or the tips of tools can be quickly identified and selected anywhere. As a locking aid, long tools can be pushed through to the bottom and held in place. The well thought-out bends of the holder prevent pliers or tweezers from slipping down.

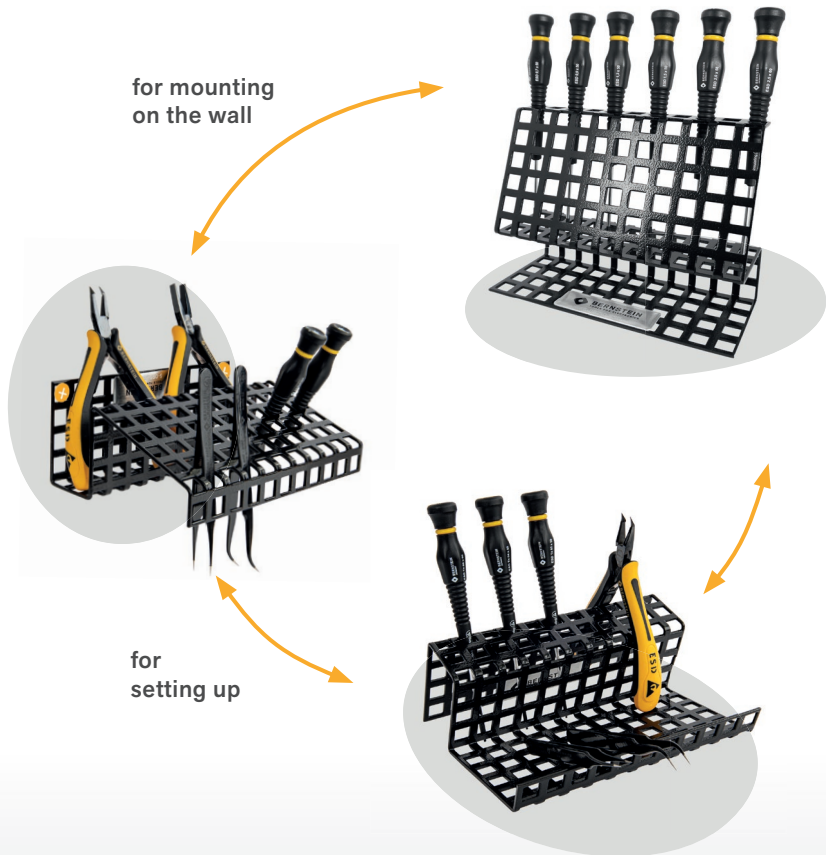

Approx. 165 x 120 x 65 mm
(dimensions for guidance)

► ESD tool holder SQUARE (without tools)

The tool holder can be set up as well as attached. Due to the many holes it is possible to choose his personally useful wall mounting. Try it out! With this - different holder - is certainly a lot of things possible.

Art.-No.	Content
NEW 5-092-0	VARIOTronics, conductive (10 ⁶ - 10 ⁹ Ohm)
NEW 5-092-1	VARIOcrafts, grey

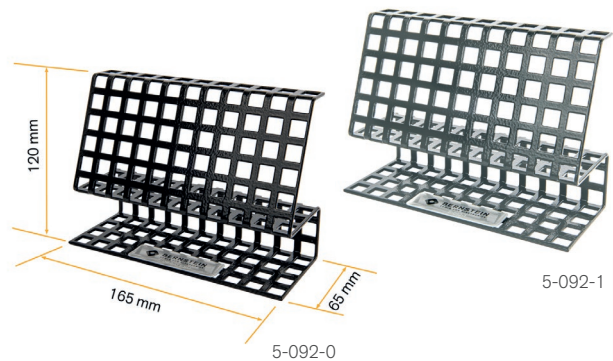

► 5-170-0



ESD tweezers holder TWEEZ

made of steel, ESD powder coated RAL7035, conductive 10⁴ - 10⁵ Ohm
storage of up to 11 tweezers or other suitable tools clearly arranged and ready to hand at any time for standing or hanging, weight: 170 g



approx. 125 x 40 x 50 mm
(dimensions for guidance)

NEW

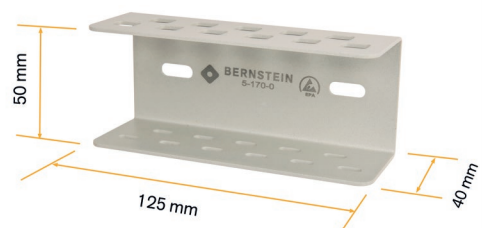

NEW

► 5-180-0-ST



ESD tool holder ZEE

made of steel, ESD powder coated RAL7035, conductive $10^4 - 10^5$ Ohm
tools clearly arranged and ready to hand at any time
for standing or hanging, weight: 216 g



approx. 125 x 40 x 50 mm
(dimensions for orientation)

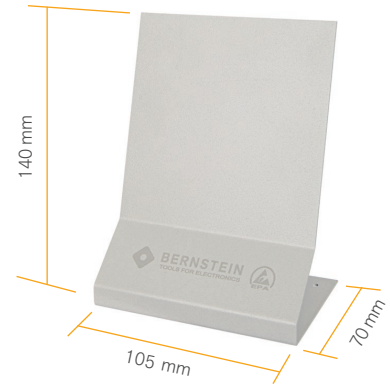

ESD HELPING TOOLS AND ORGANIZER



EPA suitable. For working in electrostatically protected areas (ESD workplace / ESD protection zone).

► **ESD boxes for SMD components (PU10)**

storage box for microprocessors, boards, chips, etc.
conductive 10^2 to 10^5 ohm, to stick together
lid with spring mechanism, known as „mouse toilet“

Art.-No. set	9-321-VE10	9-322-VE10	9323-VE10
Inner dimension	16 x 12 x 15 mm	37 x 12 x 15 mm	41 x 37 x 15 mm
Weight	5 g	10 g	15 g



► **9-324**

ESD boxes for SMD components (10 pcs)

Storage box for microprocessors, circuit boards, chips, etc.
conductive 10^2 to 10^5 ohm, to stick together
5 pieces inside measures 16 x 12 x 15 mm
5 pieces inside measures 37 x 12 x 15 mm

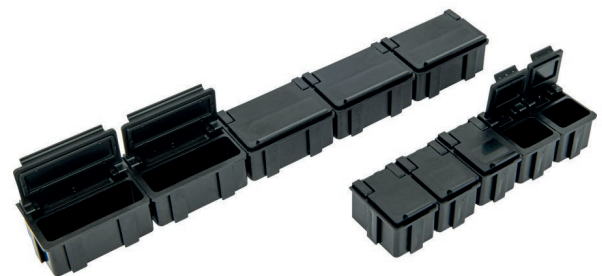

► **9-314**

ESD chip container

Storage box for microprocessors, circuit boards, chips, etc.
conductive 10^2 to 10^5 ohm, with conductive foam inlay
Innenmaße 130 x 18 x 14 mm, Gewicht: 15 g



BALL JOINT HOLDER SINGLE PARTS VARIO



All these accessories can be connected to the holders (base parts) via the M12 screw connection.

Vice Head

Jaw width 50 mm, clamping pressure 1470 N
clamping width 70 mm, clamping depth 38 mm
Glued-in ESD conductive plastic jaws corrugated (waffle iron pattern)
Dimensions for orientation 180 x 70 x 50 mm, weight 560 g

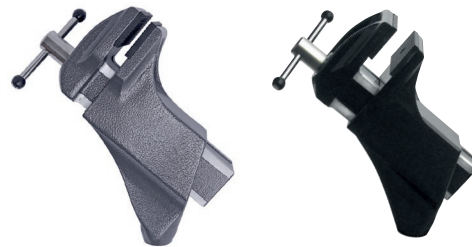

9-252

9-252 ESD

- ▶ **9-252** Colour dark gray metallic, surface structure
- ▶ **9-252 ESD** Colour black ESD dissipative $10^7 - 10^8$ Ohm, EPA suitable

▶ 9-253-ESD PCB / Circuit Board Holder

two black ESD holders with suspension for sensitive circuit boards
adjustable span up to 270 mm, with internal groove for a tight fit of the PCB
Height of the support rods 70 mm, steel parts nickel-plated
Dimensions for orientation 310 x 120 x 30 mm, weight 280 g

**stable assembly frame rotatable, PCB holder for SMD / THT
fits on quick turn device 9-257 or angle adapter 9-255
mostly used with 9-256 cover plate**



▶ 9-256 Cover plate ESD soft foam for THT equipment

is pushed from the right or left onto 9-253, so that the components to be soldered
are held in the right place by the foam, so that after the circuit board holder has been
turned all parts and components remain in their place
Soft foam size 240 x 130 mm, thickness 20 mm
ESD plastic, ESD foam, chrome-plated steel parts
Overall dimensions for orientation 280 x 130 x 20 mm, weight 260 g



▶ 9-257-ESD Quick turn device for 9-253

enables the circuit board holder with the circuit board to be rotated by 180 ° at
lightning speed without loosening an adjusting screw, stops automatically due to
the rotation limiter, Color black ESD dissipative 107 - 108 Ohm, EPA suitable
Orientation dimensions approx. 280 x 130 x 20 mm, weight 270 g



▶ 9-255-ESD Angle adapter turning circle extension

to expand the turning circle of the joint ball in the ball joint holder
with easy-to-use adjusting screw for quick tightening and loosening
Color black ESD dissipative 107 - 108 Ohm, EPA suitable
Orientation dimensions approx. 100 x 55 mm, weight 95 g



Universal machining plate to screw on

3 elongated holes 62 x 6 mm for fastening individual devices
Slots for common standard screws up to M12
for setting up stops, tuners, line transformers, prototypes and much more
is also often used in woodworking
Orientation dimensions Ø100 x 14 mm, weight 95 g

- ▶ **9-254** Colour dark gray metallic, surface structure
- ▶ **9-254-ESD** Colour black ESD dissipative $10^7 - 10^8$ Ohm, EPA suitable



9-254

9-254-ESD

ESD BALL JOINT HOLDER

Included in delivery: schnorr washer, lock nut and lock nut for the thread.



These ball joint holders have a dissipative surface with a leakage resistance between $10^7 - 10^8$ Ohm Ohm. EPA suitable (for electrostatically protected areas, ESD workplace, ESD protection zone) for working on and with sensitive parts and components. The base sections can be connected to the grounding point on the back with a 10 mm push button.



Art-No.	9-251-ESD-SET1	9-261-ESD-SET1
Ball Joint Holder	9-251-ESD	9-261-ESD
9-343-1 ESD grounding cable 1 MOhm, 1.8 m	✓	✓
9-359-2 ESD Earthing plug 2 x 1 MOhm, screw connection M5 for 4 mm eyelet	✓	✓

ESD BALL JOINT HOLDER VARIO

With the SPANNFIX VARIO, PCBs / circuit boards up to a length of 270 mm can be clamped. Thanks to the infinitely adjustable ball, the PCB can be positioned and held securely in all directions. Quick turning of the PCBs is possible thanks to the adapter. Very useful as a third hand when soldering or assembling, sensible clamping and holding device with quick release mechanism.

Thanks to the practical cover plate* all inserted components are held in place when turning the PCB and can be soldered conveniently from the other side.



Art-No.	9-240-ESD	9-270-ESD	9-250-ESD
Ball Joint Holder	9-251-ESD	9-251-ESD	9-251-ESD
9-343-1 ESD grounding cable 1 MOhm, 1.8 m	✓	✓	✓
9-359-2 ESD Earthing plug 2 x 1 MOhm	-	-	-
9-253-ESD PCB Holder	✓	✓	✓
9-255-ESD Angular Adapter	✓	-	-
9-257-ESD Rapid turning device	-	✓	✓
9-256-ESD Cover Plate*	-	✓	-
9-252-ESD Vice head - jaws 50 mm	-	-	✓
9-254-ESD Universal screw-on plate	-	-	✓

INDUSTRIELLE LED-MAGNIFYING LAMPS

Optimum illumination according to the most modern, economical standard. The closed construction makes it a ideal instrument for mechanical, electronic, or other precision applications as well as for the printed circuit board, dental and jewellery industries.

Therefore, the highest value is placed on the light quality of the magnifier luminaires. They have powerful light sources with excellent luminous efficacy.

The quality and precise positioning of the light sources in relation to the lens allows almost shadow-free magnification and excellent colour rendering. The crown-glass-lens has a lower refractive index than magnifier luminaires with plastic lenses. It reduces the loss of light transmission through the lens, resulting in less image distortion.

The three-dimensional function is particularly useful for inspections and rework on printed circuit boards and similar delicate objects.

The loupes are specially designed to maximize horizontal and vertical movements. They are characterized by a considerable horizontal action radius and always maintain the correct position without drifting off. Exact positioning is possible thanks to the flexibility of the self-balancing arm and the joint between the lamp head and the arm.

The following types are available:

CHARACTERISTICS	9-161 	9-101	9-104 NEW	9-115 NEW	9-116 NEW
glass lens	5 dioptries (2.25x magnification)	3 dioptries (1.75x magnification)	3,55 dioptries (1,9 x magnification)	6,0 dioptries (2,5x magnification)	6,0 dioptries (2,5x magnification)
LED module	2 x 6 W	1 x 10 W	12 W	approx. 5 W	approx. 5 W
3 step dimmer	0-50-100%	0-50-100%	0-40- 60-100 %	-	-
focal length	297 mm, 4600 lux	330 mm, 1500 lux	200mm, 6000 lux	150 mm , 6000 lux	150 mm , 6000 lux
colour temperature (CCT)	4000 K	4000 K	6500 K	6200 K	6200 K
colour rendering index (CRI)	Ra 80	Ra 80	Ra >85	Ra >85	Ra >85
crown glass	rectangular 171 x 114 mm	round Ø 127 mm	round Ø 132 mm	round Ø 76 mm	round Ø 76 mm
power	13 W	11 W	15 W	4,6 W	4,6 W
voltage	230 V / 50 Hz	230 V / 50 Hz	230 V	24 V	24 V
shutoff	automatically after 4 or 9 hours	automatically after 4 or 9 hours	-	-	-
arm length	1050 mm	1000 mm	900 mm	350 mm	565 mm
colour	black	white	white	black-grey	black-grey
weight	4600 g	2000 g	1300 g	680 g	780g
expandable	Secondary attachment lenses (STAYS) with 4, 6 or 10 dioptries can be attached to the crown glass lens. (STAYS: Self-Traction Accessory Yield System)		Extendable with add-on lenses by 4, 6 and 10 dioptries respectively	-	-

▶ 9-161

ESD LED magnifier light WAVE 5 dioptres

Flexible, self-balancing steel light arm, with aluminium head and table clamp (AH clamp). Efficient, dimmable, shadow-free 3D illumination, selectable LED left/right illumination. High-quality crown glass lens for maximum clarity, precision and visual comfort.

Industrial magnifier luminaires with powerful light sources and optimum illumination according to the latest economic standards. The quality and precise positioning of the light sources in relation to the lens enable almost shadow-free magnification. The crown glass lens has a lower refractive index than magnifier luminaires with plastic lenses, and reduces light transmission loss, resulting in less image distortion. Exact positioning is possible thanks to the flexibility of the self-balancing arm and the joint between the luminaire head and the arm. 5 year warranty, supplied with dust cover and EU plug

Magnification: 5.0 dpt

Lens dimensions: 171 x 114 mm



▶ 9-101

LED magnifying lamp LFM 3.0 dioptres

Round magnifying lamp in modern lightweight construction with small dimensions, as metal construction with LED (light emitting diode) light sources and a flexible spring arm. The glass lens with a diameter of 127 mm is located in the middle of an LED light ring. This enables perfect illumination of objects for shadow-free viewing.

Applications: Excellent for precision work, including electronic rework, deburring, sample preparation, preparation, assembly and manipulation, and wherever the smallest possible magnifying lamp is required.

Magnification: 3.0 dpt

Lens diameter: 127 mm



▶ 9-104

LED magnifying lamp LFM 3.0 dioptres

The magnifying lamp is equipped with the aspherical PXM® light lens with era-tec® hard coating. The fold-down lens cover serves as dust protection. 6 joints ensure optimal alignment of the magnifier head. It features an easy-to-use panel with separate buttons. The ring light, made of 84 long-life, high-power LEDs, ensures cast-shadow-free, uniformly bright illumination of the work surface.

Magnification: 3.55 dpt

Lens diameter: 132 mm



Flexible LED magnifier light 6.0 diopter



The low weight and compact dimensions as well as a high flexibility of the magnifier lamp makes it multifunctional applicable. The flexible LED magnifier lamp features segment switching and offers the choice between shadow-free LED ring illumination and segment illumination for better inspection of different surface structures. The magnifying lamp is equipped with the aspherical PXM® light lens with era-tec® hard coating. It has an optimal swivel range of the magnifier head due to the gooseneck stand in combination with the biaxial lens suspension. Lens Ø 76 mm



NEW

Art.-No.	Content	Tripod length
9-115	Flexible LED magnifier Light 6.0 diopter	350 mm
9-116	Flexible LED magnifier Light 6.0 diopter	565 mm

▶ 9-140



Weight: 230 g

PCB Inspection hand magnifier

The inspection hand magnifier is equipped with a 4.3" display, a touch screen function for intuitive operation and an HD camera for highest sharpness and best contrast even at a magnification of 4 to 15 times. The PCB hand magnifier has the ability to save images directly to the inserted SD card. Data transfer can be done via USB Type-C connection.

Battery life: 2.5- 3 hours, charging time about 2 hours.
Mains voltage of the charger: 110V - 240V, 50 - 60Hz



NEW

PCB inspection device



Weight: 6,3 kg

The PCB inspection device has a high-resolution camera with optical digital zoom (high magnification range from 1.3x to 45x). The reflection-free LCD-TFT screen in 15.6" format with the razor-sharp, true-color image in full HD aufslution offers the best working comfort. The integrated autofocus can be activated and deactivated at any time. The powerful LED illumination enables optimal work in a field of view of 265 mm. The inspection device is equipped with a user-friendly menu with customizable setting options and a swiveling camera. Data transfer can be performed via USB Type-C connection.

Art.-No.	Content
9-145	PCB inspection device
9-146	PCB inspection device with XY table



NEW

STEREO MICROSCOPES

Our microscopes are particularly suitable for the reliable inspection of material and assembly details as well as for the finest work in SMD technology.

► 9-155

stereo microscope with a stable

Stereo microscope with a stable metal tripod for incident light illumination. The field of view at a magnification of 10 x is 19 mm in diameter. The LED ring illumination has a bright, shadow-free incident light with a luminous colour of 5,800 K. The brightness can be steplessly adjusted between 0 and 15,000 lux.

CHARACTERISTICS

table stand	200 x 150 mm
magnification	10 x / 20 x expandable by attachable lenses up to 40 x
eyepieces wide field	10 x ocular tube left with diopter adjustment of + - 5 dpt, eyepiece cup
stereo head 45°	oblique view, 360° rotatable adjustable eye distance of 54 - 74 mm
Weight	5300 g



► 9-158

stereo microscope with stable hinge arm 850 mm length

Stereo microscope with stable metal tripod for incident light illumination. The field of view at a magnification of 10 x is 19 mm in diameter. The LED ring illumination has a bright, shadow-free incident light with a light colour of 5800 K. The light is illuminated by a LED ring. The brightness is continuously adjustable between 0 and 15000 lux.

CHARACTERISTICS

equipment	with stable table clamp and screw-on table base, Joint arm with 3 locking screws
magnification	10 x / 20 x expandable by attachable lenses up to 40 x
eyepieces wide field	10 x ocular tube left with diopter adjustment of + - 5 dpt, eyepiece cup
stereo head 45°	oblique view, 360° rotatable adjustable eye distance of 54 - 74 mm
Weight	5300 g

► 9-158-1

Stereo microscope conversion lens 0,5

Lens with a factor of 0.5 increases the working distance from 83 mm to 100 mm.

► 9-158-2

Magnifying optics for stereo microscopes

By screwing on the lens, the magnification changes from 10x / 20x to 20x / 40x. This reduces the working distance to 36 mm (working distance originally approx. 83 mm)



CLEANING TOOLS

Glass-fibre contact cleaner is a practical helper for users in many areas. They are perfect for cleaning, polishing or sanding the smallest surfaces. These are used in fine work for model building, for example, but the glass-fibre contact cleaner is also ideal for cleaning soldering joints and welds.

Brass wire brushes are practical helpers for cleaning, grinding, scratching and deburring. In particular, dirty threads in inaccessible places can be cleaned and derusted with the help of brass wire erasers.

We recommend to try the glass fiber eraser in an invisible area. The eraser consists of a writing sleeve which is, depending on the size, a 2 or 4 mm thick glass fiber mine. The integrated turning or printing mechanism allows infinitely variable length variation of the glass fiber lead. If a mine is used up, it is simply exchanged for a replacement mine.

▶ 2-162

Glass fibre contact cleaner brush Ø 4 mm (plastic body)

in pen form with twist mechanism, for cleaning soldering or welding spots
body completely made of synthetic, bristles made of glass fiber, brush Ø 4 mm
length 120 mm, weight 10 g, (Replacement bristles Art-No. 2-167-VE10)



▶ 2-163

Brass contact cleaner brush Ø 4mm (plastic body with metal tip)

with twist mechanism, for cleaning, polishing, grinding, for rust removal, scratching and deburring
synthetic body, with steel tip, bristles made of brass, brush Ø 4 mm
length 120 mm, weight 10 g, (Replacement bristles Art-No. 2-164-VE24)



▶ 2-166

Glass fibre contact cleaner brush Ø 4 mm (plastic body with metal tip)

in pen form with twist mechanism, for cleaning soldering or welding spots
for rust removal, polishing and grinding of smallest parts, for corrections or etchings
synthetic body with metal tip, bristles made of glass fiber, brush Ø 4 mm
length 120 mm, weight 10 g, (Replacement bristles Art-No. 2-167-VE10)



▶ 2-168

Glass fibre contact cleaner brush Ø 2 mm (plastic body with metal tip)

with clip, in pen form with press mechanism, for cleaning soldering or welding spots
for rust removal, polishing and grinding of smallest parts, for corrections or etchings
body plastic with metal tip, bristles made of glass fiber, brush Ø 4 mm
length 140 mm, weight 12 g, (Replacement bristles Art-No. 2-169-VE12)



Fiber Optic **ONE-CLICK CLEANER** designed to specially work well with the LC, MU connectors. This instrument cleans the ferrule end faces removing dust, oil, and other debris without nicking or scratching the end face. Cleaning micro fibers are densely stranded and debris free extendable tip reaches recessed connectors. When pressed, the tip placed on the connector rotates 180 degrees and performs a cleaning movement with an acoustic click. Made from anti static resin, Disposable with 800+ cleanings per unit, detailed application description enclosed. Applications for Fiber network panels and assemblies, Outdoor FTTX applications, Cable assembly production facility, Testing laboratories, Server, switches, routers and OADMS with LC/MU or SC/FC/ST interface.
Length 180 mm, Weight 21 g

▶ 2-171

Fiber optic pen type cleaner for SC/FC/ST adapter connector

Cleans SC, FC and ST connectors Ø 2.5 mm connections (APC and UPC) mounted on the adapter.
Dust cap is included.



▶ 2-172

Fiber optic pen type cleaner for MU/LC adapter connector

Cleans adapter mounted MU, LC connector Ø 1.25 mm. Dust cap is included.



▶ 7-421

ESD Brush bristles Ø 6 mm , length 150 mm

EPA suitable. For working in electrostatically protected areas (ESD workplace / ESD protection zone).



▶ 7-422

ESD Brush bristles width 20 mm, length 147 mm

EPA suitable. For working in electrostatically protected areas (ESD workplace / ESD protection zone).



▶ 2302

ESD Tool set OPERATOR KIT 5 pcs.

EPA suitable for electrostatically protected areas (ESD workplace / ESD protection zone). Dissipative tool set in lockable imitation leather cases for handling automatic placement machines during operation. The compact and robust bag made of dissipative imitation leather fits well into any work coat bag. Injuries caused by pointed and loosely inserted tools can thus be prevented. Measures 135 x 150 x 25 mm, weight 190 g

**Content**

1-150-0-ESD	ESD dissipative bag
4-607	ESD screwdriver slot blade 3.0 x 0.5 x 60 mm
4-623	ESD screwdriver cross-recess PH0
5-078-13	ESD SMD universal tweezers 130 mm form PSF stainless steel dissipative
7-421-1	ESD/EGB brush shortened to 140 mm, rounded corners
5-310-13	ESD scissors rounded dissipative handle

2302

▶ 2-126

ESD Desoldering lever with slot 0.7 x 2.0 mm

to replace or lifting stuck components for desoldering, blade-Ø 3.5 mm, blade width 3.58 mm blade depth 2.0 mm, slot width 0.7 mm, blade quality steel, mat chrome-plated ESD handle with rotating cap (dissipative 10^5 to 10^7 Ohm) length 147 mm, weight 17 g



▶ 2-127

ESD Tin knife blade pointed sharp steel-blade

7 mm wide blade with, bevelled very sharp edge, Blade protrudes 41 mm from the handle largely insulated, dissipative ESD handle with rotating cap (dissipative 10^5 to 10^7 Ohm) for interrupting conductive tracks, length 140 mm, weight 16 g



▶ 2-101

ESD Tin knife blade pointed sharp ceramic-blade

3 mm wide blade with, bevelled very sharp edge, Blade protrudes 20 mm from the handle ESD handle with rotating cap (dissipative 10^5 to 10^7 Ohm), length 104 mm, weight 9 g



▶ 2-128

ESD Pewter scraper mini chisel sharp chisel form

5.25 mm wide blade with a very sharp edge, blade protrudes 40 mm from the handle largely insulated, dissipative ESD handle with rotating cap (dissipative 10^5 to 10^7 Ohm) for scraping off solder residues, excess solder, solder bridges, length 140 mm, weight 16 g



TESTING TOOLS

The test probes manufactured by BERNSTEIN are particularly thin, pointed and flexible. The fully insulated and flexible design of the test prods prevents short circuits and damage during testing and measuring, even when contacts are arranged one after another. **Measurement category CAT I, rated voltage 30 V / AC and 60 V / DC**

Art.-No.	Description	Packaging unit	Total length mm	Weight g
2-265-1	Test prod red, blade 1 mm Connection for 4 mm socket	single	155	9
2-265-2	Test prod black, blade 1 mm Connection for 4 mm socket	single	155	9
2-265-VE	Test probe red + black (pair)	pair	155	18



MAGNIFICATION TOOLS

► 1-909

Engineer mirror

magnifying Ø 23 mm with extension, plastic handle
length 145 to 260 mm, weight 9 g



► 2-275

Magnifying mirror

concave Ø 21 mm 180 mm long, plastic handle
Total length 180 mm, weight 8 g



► 2-296

Hand 3x magnifier with LED light

Magnifier can be turned out, plastic housing, bluish light, supplied with battery,
Length closed 112 mm, total length opened 172 mm, weight 18 g



► 2-656

LED Flashlight high power light

illumination range up to 50 meters, 100% waterproof and unbreakable
black synthetic, with clip for belt attachment, delivery with battery
length 140 mm, weight 40 g



► 2-298

ESD Hand magnifier 5x magnification LED light

ESD safe, suitable for the EPA area, material (plastic part) conductive PP black
surface resistance 10^5 to 10^8 Ohm, magnifying glass diameter 62 mm
LED illumination: 5x LED white, 1x LED UV
battery operation 2x AAA (delivery without battery), length 200 mm, weight 25 g

Risk factor loupes and lighting! At the ESD workstation, sensitive components must not be exposed to an electrostatic field of more than 100 V / cm. There is a high risk due to the use of highly rechargeable materials such as glass or plastic. Above all, loupes and lights are dangerous because they are often used very close to the product. An electrostatic discharge can also occur via the air, it is not always a direct contact necessary. For this reason, only use ESD-safe lighting like this item, in accordance with DIN EN 61340-5-1.



OPENING AND LIFTING TOOLS

Opening tools for opening hard-to-reach electronic devices such as smartphones, tablets, notebooks, and many more.

▶ 2-113

ESD Lifting tool, Opening tool

Very stable, break-proof glass fiber reinforced polyamide, typical leakage resistance approx. 10^9 Ohm for opening sensitive housings, 3 different material thicknesses allow lever attachment of different gap dimensions, including flat metal insert for scratch-resistant areas
length 180 mm, weight 22 g



▶ 2-123

ESD crowbar SPUDGER metal opener flat

For levering off micro plug connections in electronic devices. EPA suitable. For working in electrostatically protected areas (ESD workplace / ESD protection zone).
length 180 mm, weight 19 g



▶ 2-124

Opening tool BERNSTEIN metal opener flat

0.2 mm spring plate deburred, very narrow filigree opening tool for small slots
different radii offer different lever approaches, flexible through the spring plate without breaking off, often used for the first opening, then to prise open further with a larger opening tool
length 120 mm, weight 12 g



▶ 2-129

Opening tools plastic 10 pcs

Insulating plastic consumables, set consisting of:
2-129-1 opening tool triangle orange (6 pcs)
2-129-2 opening tool darts orange (3 pcs)
2-129-3 opening tool pen pointed orange



▶ 2-111-VE3

LCD Opener suction cup with ring (PU3)

Ø 40 mm suction cup holder transparent, strong holding suction cup
screwed suction cup and handle ring, suction cup with M4 thread
ideal for holding / opening LCD displays
6 mm thread length, stainless steel (V2A) rustproof
suction cup material soft PVC, hard plastic holder / nickel-plated ring
Dimensions 40 x 45 mm, weight 50 g



MAKESHIFT TOOLS

▶ 2-119

Magnetic mat + waterproof pen + eraser sponge

rewritable pad for the repair of small electronic devices, such as smartphones, hearing aids, etc.
Dimensions 250 x 200 mm, weight 200 g, Set consisting of:
2-119-10 Work mat magnetic 250 x 200 mm
2-119-11 Wiping sponge for magnetic mat
2-119 ST STAEDTLER black foil pen 0.6 mm



MAKESHIFT TOOLS

Claw grippers are used when it is not necessary to recover magnetic small parts from hard-to-reach areas. As well as the magnetic lifter, the claw grab has a flexible, well-aligned steel shaft and a robust and smooth claw mechanism with hardened claws, which will withstand long-term professional demands and fine adjustment. It is available in different sizes, whether individually or in an individual set.

▶ 2-155

Claw-type gripper with 3 hardened wire claws

opening up to max. 12 mm, comfortable use and precise gripping
handle ergonomically shaped, length 165 mm, weight 50 g



▶ 2-155-13

ESD claw-type gripper with 3 hardened wire claws

same as 2-155 with dissipative ESD coating 10^6 and 10^9 ohm



▶ 2-157

Flexible claw-type gripper with 4 spring claws

nickel plated, long version
length 600 mm, weight 75 g



▶ 7-521

Scriber 200 mm

for marking, scribing, scoring, engraving, needle \varnothing 2.5 mm
one side bent 90° , point angle is 15°
aluminum handle \varnothing 6 mm, finely milled for optimum grip
material aluminum/tool steel, needles hardened and burnished
length 200 mm, weight 26 g



▶ 2-131

Spring puller, spring hook 205 mm

for hooking in and out of tension springs
material high-quality steel, nickel plated and insulated
length 205 mm, weight 10 g



▶ 2-132

Spring puller, spring hook 175 mm

material high-quality steel, nickel plated and insulated
length 175 mm, weight 8 g



▶ 2-133

Spring puller, spring hook with ring 195 mm

material high-quality steel, nickel plated and insulated
length 195 mm, weight 12 g



▶ 2-130

Set of spring pullers 6 pcs

2-131, 2-132, 2-133 in a plastic pocket
Material quality steel, nickel-plated, not insulated in the middle
length 195, 175, 205 mm weight: 39 g



▶ 2-620

PLCC-extractor

For work on circuit boards (PCB) for easy excavation of parts and components enables removal of integrated circuits, safe removal without the risk of damaging the pins material: plastic and metal compound, length 100 mm, weight 21 g



▶ 2-161

Scriber, magnetic lifter with telescopic slide-out

Slim, elegant design, max. lifting force 0.025 kg, needle Ø 7 mm, extra hardened for small, light metallic objects in hard-to-reach places pen shape with clip for carrying in the breast pocket, telescopic rod max. 655 mm Total length 145 mm, weight 34 g



▶ 2-800

Miniature tap and die set 30 pcs (M1.0 - M2.5 mm)

18 taps, each with a pre-cutter and a finish cutter
each 2 x hand taps (HGB) each M 1.0 - M 1.1 - M 1.2 - M 1.4 - M 1.6 - M 1.8 - M 2.0 - M 2.2 - 2.5
each 1 x dies M 1.0 - M 1.1 - M 1.2 - M 1.4 - M 1.6 - M 1.8 - M 2.0 - M 2.2 - M 2.5
1 x die holder
2 x tap wrenches
2 matching reducing rings
high speed quality steel (HSS) polished
in a practical storage box, measures 150 x 85 x 15 mm, weight 199 g



DESOLDERING SUCTION PUMPS

▶ 8-390

desoldering suction pump PRAKTIK Ø 20 mm RD-7376

handy device in all-metal housing
high suction power due to 2-fold sealing of the piston
length 200 mm, weight 71 g



▶ 8-238

SMD vacuum pipette Vampir

for simple, safe and precise handling of SMD components,
angled suction nozzle and 3 suction cups 4, 6 and 9 mm (conductive)
length 150 mm, weight 60 g



GAS SOLDERING IRON

▶ 8-376

Gas soldering iron, works with butane lighter gas

operating time 45 minutes, Ignition with piezo-electronic system
soldering tip width 2 mm, tip temperature up to soldering: 580°C/1075°F
blow torch: 1300°C/2372°F, hot air tip 625°C/1157°F, hot knife 580°C/1075°F
75 wattage, TUV approval, length 170 mm, weight 94 g



Perfect for all mobile applications. The soldering iron is ignited by a piezo-electronic system. The on/off switch is marked with 1-0, the ignition switch is marked with a lightning. Soldering, hot air or hot knife by the placement of different soldering tips possible. Please note the enclosed instructions for use.

SCISSORS

► 5-161

Clamping scissors with teething jaws

for holding and clamping, no cutting function, serrated on both sides
jaws length 25 mm, material high-quality steel, Surface chrome plated stainless
length 130 mm, weight 80 g



► 5-301

Scissors with teething

micro serrated one blade, for round, flat and shrouded wires, cutting length 15 mm
material high-quality steel, Surface chrome plated stainless
length 110 mm, weight 27 g



► 5-301-13

ESD scissors with teething, dissipative

like 5-301 with dissipative ESD coating 10⁹ to 10⁹



► 5-302

Electrician scissors with teeth and stripping function

for cutting and stripping for wire, one blade fine serrated, both outer sides toothed
for round, flat and shrouded wires, cutting length 45 mm
very stable and robust scissor, material high-quality steel, Surface chrome plated
length 130 mm, weight 67 g



► 5-305

Combination scissors, slicer

with compression spring and lock in closed position, smooth precision cutting
external edge toothed, one-side, cutting length 30 mm
very stable scissor, material stainless steel, polished surface
ergonomic plastic handles, length 145 mm, weight 58 g



► 5-306

Scissors, black lacquered, polished head

No ESD coating, cutting length 30 mm, very robust scissor
material high-quality steel, length 180 mm, weight 85 g



► 5-308

Scissors with fine teething

one-sided very fine serrated, precision cutting, sharp scissors very robust
cutting length 45 mm, material high-quality steel, Surface chrome plated
length 125 mm, weight 59 g



► 5-308-13

ESD scissors with fine teething, dissipative

like 5-301 with dissipative ESD coating 10⁹ to 10⁹



► 5-311

Kitchen scissors

smooth precision cutting, cutting length 70 mm
very stable and robust scissor, material high-quality steel
length 180 mm, weight 80 g



SCISSORS AND KNIFES

▶ 5-310

Scissors with round tips

smooth precision cutting, cutting length 45 mm
material high-quality steel, surface chrome plated
length 130 mm, weight 55 g



▶ 5-310-13

ESD scissors rounded, dissipative

like 5-301 with dissipative ESD coating 10^6 to 10^9



▶ 5-352

ESD scissors with dissipative handle

smooth precision cutting, cutting length 80 mm, cutters stainless and acid resistant
material stainless steel, handle dissipative between 10^6 to 10^8 ohm EPA suitable
for working in electrostatically protected areas (ESD workplace / ESD protection zone)
complies with DIN EN 61340-5-1, length 180 mm, weight 55 g



▶ 5-353

Ceramic scissors with plastic handle

smooth precision cutting, for cutting kevlar and aramid fibers
cutting length 75 mm, cutters stainless and acid resistant
length 190 mm, weight 80 g



▶ 5-515

Cutter knife

9 mm blade strips adjustable and breakable, backwards with a clip
very stable and durable, material metal body, powder coated
blades made of special stainless steel, length 140 mm, weight 10 g
(spare parts blades Art-No. 5-516)



5-515

▶ 5-517

Cutter knife

18 mm blade strips adjustable and breakable, very stable and durable
body made from plastic ergonomically shaped, blades made of special stainless steel
length 160 mm, weight 55 g (spare parts blades Art-No. 5-518)



▶ 5-519

ESD cutter knife dissipative

18 mm blade strips adjustable and breakable, very stable and durable
blades made of special stainless steel, body dissipative between 10^6 to 10^8 ohm
EPA suitable for working in electrostatically protected areas
(ESD workplace / ESD protection zone) complies with DIN EN 61340-5-1
length 140 mm, weight 39 g (spare parts blades Art-No. 5-518)



▶ 2-102

Scalpel handle with 5 blades

Material quality steel, stainless steel blades, exchangeable handle 125 mm, exchangeable blades

Art.-No.	Content	Art.-No.	Content
2-102-1	Scalpel handle	2-102-4	Blade no. 11 (5 x 42 mm)
2-102-2	Blade no. 10 (7 x 42 mm)	2-102-5	Blade no. 12 (6 x 40 mm)
2-102-3	Blade no. 10 A (8 x 42 mm)	2-102-6	Blade no. 13 (7 x 42 mm)



2-102-2

2-102-1



2-102-3



2-102-4



2-102-5



2-102-6

FILES AND HAMMER

► 5-210

Needle files set 6 pcs

content: article listing see below, precision mechanic files in high-quality
24 strokes on 1 cm, File length 80 mm, Handle length 60 mm
length 140 mm, weight 50 g, 100% Made in Germany

Art.-No.	Type	Handle length	Total length	Weight in g
5-201	flat-blunt	100	140	7
5-202	flat-pointed	100	140	6
5-203	round	100	140	6
5-204	half round	100	140	6
5-205	triangular	100	140	6
5-206	square	100	140	6



► 5-240

Warding files set 6 pcs

content: article listing see below, precision mechanic files in high-quality
22 strokes on 1 cm, File length 103 mm, Handle length 67 mm
length 170 mm, weight 120 g, 100% Made in Germany

Art.-No.	Type	Handle length	Total length	Weight in g
5-231	flat-blunt	67	170	17
5-232	flat-pointed	67	170	14
5-233	round	67	170	13
5-234	half round	67	170	27
5-235	triangular	67	170	18
5-236	square	67	170	15



► 5-261

Contact file

22 strokes on 1 cm, precision mechanic files in high-quality
for cleaning contacts and connections, with fine strokes, flat-blunt
length 150 mm, weight 9 g, 100% Made in Germany



► 7-616

PUK saw 150 mm

Saw blade for wood and metal, span 150 mm
with adjustable wooden handle can be aligned with the frame
length 245 mm, weight 140 g

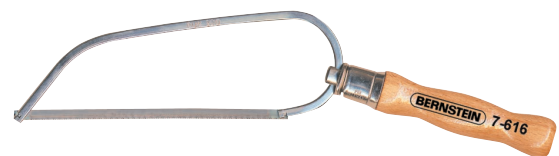

► 7-617 Saw blade for PUK (PU12)

content: 12 pcs, spare part / replacement, metal saw blade
length 150 mm, weight 3 g



► Engineer hammer according to DIN 1041

Drop forged, precision ground, tiller and track precision ground, varnished and
rust-protected, with double curved ash handle

Art.-No.	Total length	Head weight in g	Total weight in g
7-114	280	200	260
7-116	300	300	435



HAND AND MEASURING TOOLS

▶ 7-405

Trowel 50 mm wide

with conical forged leaf and wooden handle
blade width 50 mm, length 215 mm, weight 70 g



▶ 7-410

Slicker trowel 16 mm wide

polished with round stalk, length 220 mm, weight 25 g



▶ Folding rule

with angle measurement function, accuracy class 3 (III)
red/black scale color on a white background, CE mark



Art.-Nr.	total length	material	Packing size	Weight in g
7-502	2 meter	beech wood	240 x 15 mm	120
7-503	1 meter	plastic	130 x 13 mm	60



▶ 7-506

Roller tape measure 2 Meter

shockproof synthetic body, length 55 mm, weight 70 g



▶ 7-508

Steel tape measure 30 cm

Cross section 13 x 0.5 x 300 mm stainless steel, Lines and numbers etched
and dyed black, length 320 mm, weight 20 g



▶ 7-515

Feeler gauge 21 blades (0.05 - 2.0 mm)

with conical blades, material: INOX stainless quality steel
T2 tolerances depending on size +/- 0.004 mm to +/- 0.008 mm (see web)
nickel-plated cover sheet with locking screw, length 100 mm, weight 190 g



▶ 7-535

Spirit level 225 mm

with horizontal, vertical and 45° level, material synthetic
length 225 mm, weight 58 g



▶ 7-511

Digital caliper with data output 150 mm (6 inch)

according to DIN862, bottom beak 40 mm, top 10 mm, Tolerance 0.02 mm
3-digit LCD display, large display, switchable metric / inch
with depth gauge and locking screw, display body plastic, ruler made of steel
delivery in protective plastic box and with battery, length 250 mm, weight 200 g

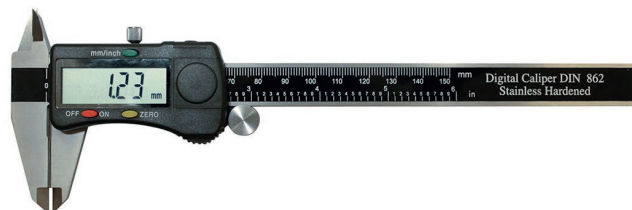

▶ 7-516

Analogue caliper 150 mm

bottom beak 40 mm, top 10 mm, tolerance 0.05 mm, with fine roller
and locking screw, with NONIUS scale, measure outside dimensions
inside dimensions, depth dimensions, waterproof, oil resistant
INOX stainless quality steel, in stable plastic box
length 230 mm, weight 150 g



TERMS OF SALE AND DELIVERY

GENERAL

The nature and scope of delivery are specified in the order confirmation. The following delivery terms shall apply to all deliveries to be carried out by us. Purchasing conditions of the customer do not oblige us, even if we do not expressly contradict this. Verbal or by intercom agreements made require our written confirmation. Obvious mistakes in offers, order confirmations, etc. are expressly reserved and can be considered at any time. We are entitled to process any data relating to the business relationship or in connection with the same concerning buyers, whether the buyer itself or third parties, within the framework of the Federal Data Protection Act.

OFFER

Our offers are permissive, an order is deemed to be granted if confirmed by us in writing. PRICES, DELIVERY BASIS AND PACKAGING Unless otherwise agreed, the prices in Euros, ex works, are exclusive packaging. In the case of special packaging regulations of the customer, the additional costs involved are invoiced. Packaging is not accepted.

DELIVERY

The delivery takes place at the expense and risk of the buyer without regard to who bears the freight costs. We reserve the right to place orders in partial deliveries. For custom-made products, excess or short deliveries of up to 10% are permitted.

DELIVERY TIME

The delivery time begins upon receipt of all information required for the execution of the order. We endeavor to comply with the delivery time specified in the order confirmation. No claims of any kind can be asserted from a delayed delivery.

COMPLAINTS

Complaints can only be accepted within 8 days after receiving of the goods.

The shape and colour of the tool may differ from the item shown in the catalogue.

GUARANTEE

For all BERNSTEIN tools, which are unusable due to proven material or manufacturing defects, we deliver within one year after deliver a replacement. This free replacement service is excluded if the tools have become unusable due to natural wear or improper handling.

DISCLAIMER

We do not assume any guarantee for the suitability of our products for the intended purpose of the customer. For damages caused by unsuitable or improper use, commissioning by the customer or third parties, and for the natural wear and tear we assume no guarantee. Any claims for damages, irrespective of the legal basis, as well as, in particular, the liability by tort (product liability) are excluded to the extent permitted by law.

PAYMENT

Our invoices are payable within 10 days of the invoice date with 2% discount or in 30 days net, unless otherwise agreed in the order confirmation.

RESERVATION OF TITLE

We reserve the title to all goods delivered by us until the buyer has paid all claims arising from the business relationship. The buyer is entitled to resell the reserved goods in ordinary business transactions. In the case of resale, the buyer has to reserve the ownership of the sold goods on the same terms as his customer. The purchaser hereby assigns to us the purchase price claim against the buyer from the resale.

FULFILLMENT AND JURISDICTION

Place of performance and jurisdiction for delivery and payment is Remscheid. In any case, only German law shall apply, with the exclusion of any foreign law.

ONLINE DISPUTE RESOLUTION

The European Commission provides a platform for online dispute resolutions (ODR) which can be accessed at

<https://ec.europa.eu/consumers/odr/> .

In order to settle dispute arising from a contractual relationship with a consumer or from whether such a contractual relationship exists at all, we will participate in dispute settlement proceedings before a consumer dispute resolution body. Consumers can contact their national European Consumer Centre in this regard. The respective contact details of the individual ECCs can be found at

<https://www.evz.de/en/alternative-dispute-resolution/adr-in-europe/>.

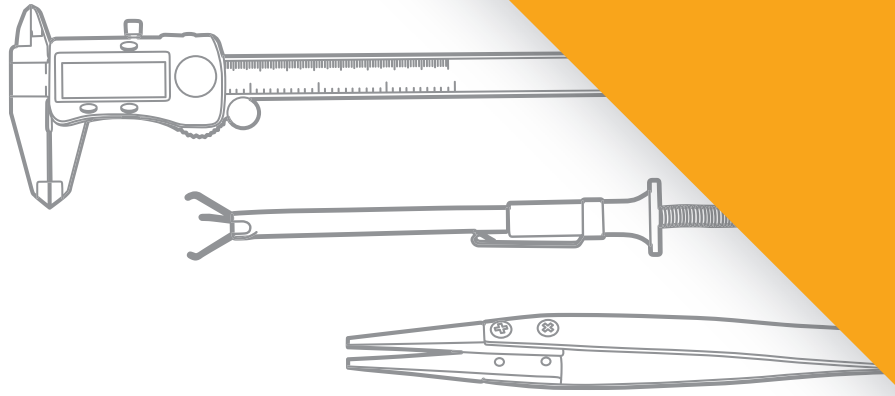



A little story about
the word amber (BERNSTEIN)

The greek word for amber is „elektron“: the root of today's term electronics. Even the greeks discovered the special feature of amber: by rubbing the natural amber can be electrostatically charged. The charged stone can attract dust particles.

Today you can use this property to check the authenticity of an amber. If it is real, it can be tested through charge rubbing on a cotton cloth.

You can also wear it as jewellery:
it should protect from evil magic and give joy of life.

Just like our high-quality BERNSTEIN
ESD Tools - them protect against
electrostatics and give joy with
the daily work.

(Autor Max Walter Hartmut Blombach)

BERNSTEIN

**Werkzeugfabrik
Steinrücke GmbH**

Industriehof Trecknase 1
42897 Remscheid

Tel. + 49 (0) 2191 - 9650 - 0
Fax + 49 (0) 2191 - 9650 - 30

sales@bernstein-tools.de
www.bernstein-tools.de

X-ON Electronics

Largest Supplier of Electrical and Electronic Components

Click to view similar products for [Bernstein](#) manufacturer:

Other Similar products are found below :

[05-0030](#) [1-151](#) [1-152](#) [1-153](#) [1-154](#) [1-155](#) [1-156](#) [1-157](#) [1-303](#) [1-307](#) [13-806-VDE](#) [13-906-VDE](#) [13-916-VDE](#) [13-938-VDE](#) [13-946-VDE](#) [1-406](#) [14-651-VDE](#) [14-682-VDE](#) [14-685-VDE](#) [14-695-VDE](#) [14-696-VDE](#) [15-501-VDE](#) [15-506-VDE](#) [15-522-VDE](#) [15-531-VDE](#) [16-301-VDE](#) [16-441-VDE](#) [16-475-VDE](#) [16-538-VDE](#) [16-543-VDE](#) [16-545-VDE](#) [1-725](#) [1-735](#) [1-739](#) [17-501-VDE](#) [1-751](#) [17-521 VDE](#) [1-753](#) [17-547-VDE](#) [1-755](#) [1-756](#) [1-851](#) [1-852](#) [1-854](#) [1-855](#) [1-856](#) [1-861](#) [1-909](#) [1-978](#) [2100](#)