

承认书

APPROVAL SHEET

Conductive Polymer Hybrid Aluminium Electrolytic Capacitors

导电高分子混合铝电解电容器

客户CUSTOMER:

系列 SERIES:

TB

规格尺寸 ITEM:

100 μ F35V 6.3X8

绿宝石料号 BERYL P/N:

HTB035M101E080SM1R

客户料号 CUSTOMER P/N:

日期 DATE:

编号 NO.:

20240403Q

BERYL		
Authorized by	Checked by	Prepared by
批准	审核	制作
罗伟	陈桃桃	蒋嘉雯

CUSTOMER		
Authorized by	Checked by	Prepared by
批准	审核	制作

索引 Index

- 1 修订履历 Revision Of Resume
- 2 绿宝石料号 BERYL Product Part No
- 3 产品特性 Characteristics
- 4 产品尺寸 Product Size
- 5 印字 Marking
- 6 产品结构图 Product Structure Diagram
- 7 电气特性 Electrical Characteristics
- 8 焊接条件 Welding conditions
- 9 操作注意事项 Operating Precautions
- 10 环保 Environmental protection



制订/修订履历表 Revision Of Resumes

编号NO.	版本Version	内容Content	日期Date
20240403Q	20240403Q-1		2024年4月3日

2.绿宝石料号 BERYL Product Part No

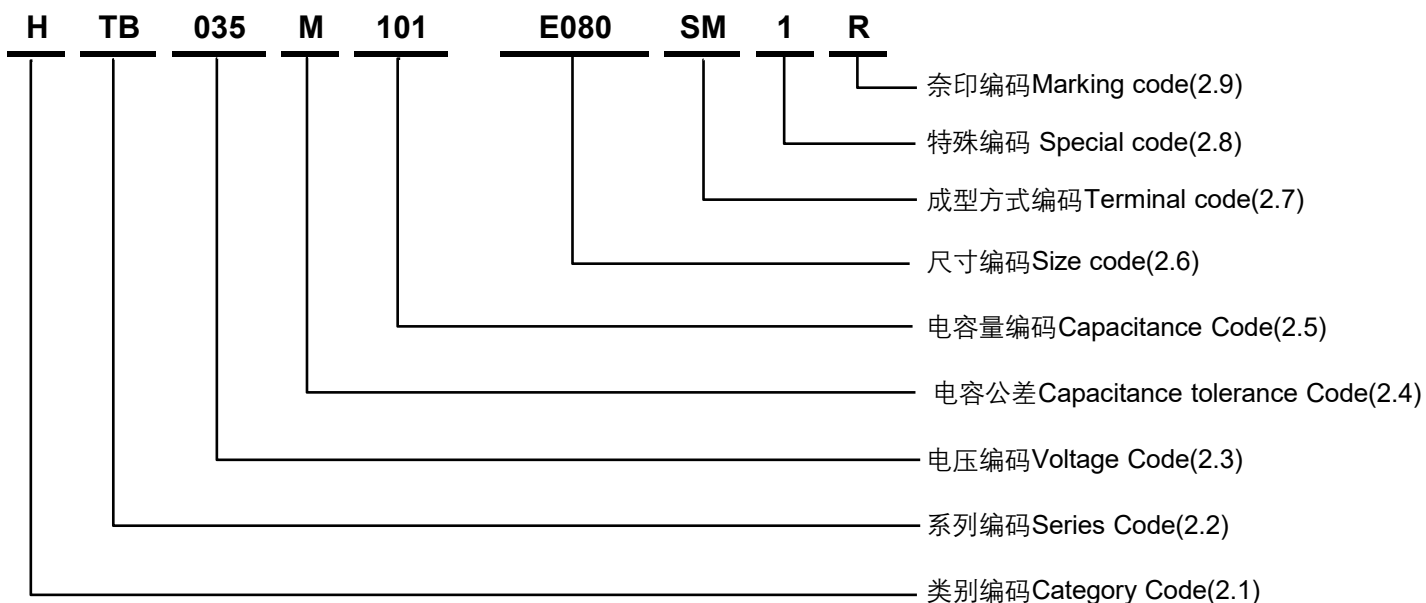

2.1 类别编码Category Code

编码Code	H
类别编码Category Code	导电高分子混合铝电解电容器 Conductive Polymer Hybrid Aluminium Electrolytic Capacitors

2.2 系列编码Series Code

编码Code	TB
系列编码Series Code	TB

2.3 电压编码Voltage Code

编码Code	035
电压编码VoltageCode(W.V)	35

2.4 电容公差Capacitance tolerance Code

编码Code	M
电容公差Capacitance tolerance Code	±20%

2.5 电容量编码Capacitance Code

编码Code	101
电容量Capacitance (μF)	100

2.6 尺寸编码 Size code

编码 Code	E080
直径 D (mm)	6.3
高度 H (mm)	8

2.7 成型方式编码 Terminal code

编码 Code	SM
成型方式编码 Terminal code	SMD

2.8 特殊编码 Special Code

编码 Code	1
特殊编码 Special Code	No special requirements

2.9 捺印编码 Marking Code

编码 Code	R
捺印 Marking	Red Printing

3. 产品特性 Characteristics

绿宝石料号 BERYL P/N	额定工作电压 Rated Voltage (V.DC)	电容量 Capacitance (120Hz,20°C) (μ F)	电容量公差 Capacitance Tolerance	温度 Temperature (°C)	寿命 Load Life (hours)	浪涌电压 Surge voltage(V)
	35	100	$\pm 20\%$	-55 ~ 125	4000	40.25
HTB035M101E080SM1R	尺寸 Size Φ D×L(mm)	损失角 DF (120Hz,20°C) (% max)	等效串联电阻 ESR (100KHz,20°C) (m Ω max)	泄漏电流 LC (2min/w.v) (μ A max)	纹波电流 RC (100KHz,125°C) (mA rms)	
	6.3 x 8	16	50	35	620	

符合AEC-Q200标准的产品

Products conforming to AEC-Q200 standard (Report NO. A222016704310100402E)

3.1 纹波电流频率系数 Frequency coefficient for ripple current

频率 Frequency	120Hz \leq f < 1kHz	1KHz \leq f < 10kHz	10KHz \leq f < 100kHz	100KHz \leq f < 300kHz
系数 Coefficient	0.10	0.35	0.70	1.00

4. 产品尺寸 Product Size

4.1 外部尺寸 Outer dimensions

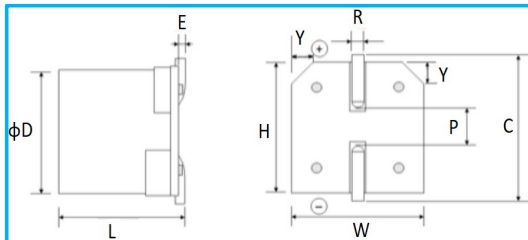

尺寸代码 Size code	ϕ D (mm)	L (mm)	E (mm)	W ± 0.2 (mm)	H ± 0.2 (mm)	C ± 0.2 (mm)	R (mm)	P ± 0.3 (mm)	Y ± 0.03 (mm)
C058	5 ± 0.5	5.8 ± 0.5	≤ 0.2	5.3	5.3	6.0	0.5~0.8	1.4	1.0
E058	6.3 ± 0.5	5.8 ± 0.5	≤ 0.2	6.6	6.6	7.3	0.5~0.8	2.1	1.5
E080	6.3 ± 0.5	8 ± 0.5	≤ 0.2	6.6	6.6	7.3	0.5~0.8	2.1	1.5
F069	8 ± 0.5	6.9 ± 0.5	≤ 0.2	8.3	8.3	9.0	0.8~1.1	3.2	1.5
F125	8 ± 0.5	12.5 ± 0.5	≤ 0.2	8.3	8.3	9.0	0.8~1.1	3.2	1.5
G105	10 ± 0.5	10.5 ± 0.5	≤ 0.2	10.3	10.3	11.0	0.8~1.1	4.6	2.0
G125	10 ± 0.5	12.5 ± 0.5	≤ 0.2	10.3	10.3	11.0	0.8~1.1	4.6	2.0

4.2 焊盘尺寸 Soldering pad dimensions

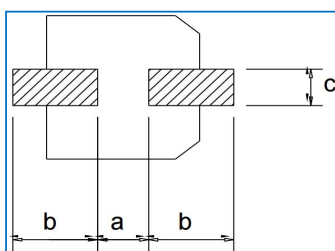

尺寸代码 Size code	a (mm)	b (mm)	c (mm)
C	1.4	3.0	1.6
E	2.1	3.5	1.6
F	2.8	4.2	1.9
G	4.3	4.4	1.9

5. 胶带包装和标签标记 Taping packing and label marking

5.1 载带尺寸 Carrier tape dimensions

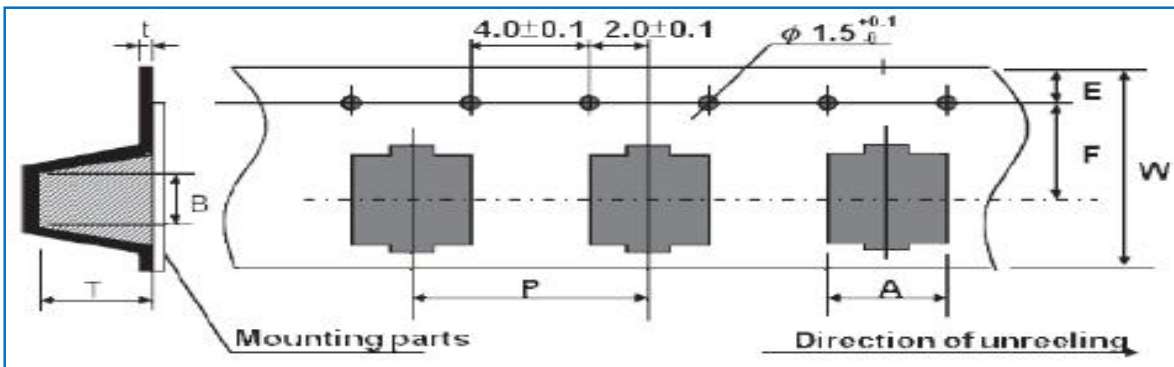

尺寸代码 Size code	A ±0.2 (mm)	B ±0.2 (mm)	W ±0.3 (mm)	F ±0.1 (mm)	E ±0.1 (mm)	P ±0.1 (mm)	t ±0.1 (mm)	T ±0.1 (mm)
5x5.8	5.6	5.6	16.0	7.5	1.75	12.0	0.4	6.2
6.3x8	7.0	7.0	16.0	7.5	1.75	12.0	0.4	8.3
8x12.5	8.6	8.6	24.0	11.5	1.75	16.0	0.4	13.0
10x10.5	10.7	10.7	24.0	11.5	1.75	16.0	0.4	11.0

5.2 卷轴尺寸 Reel dimensions

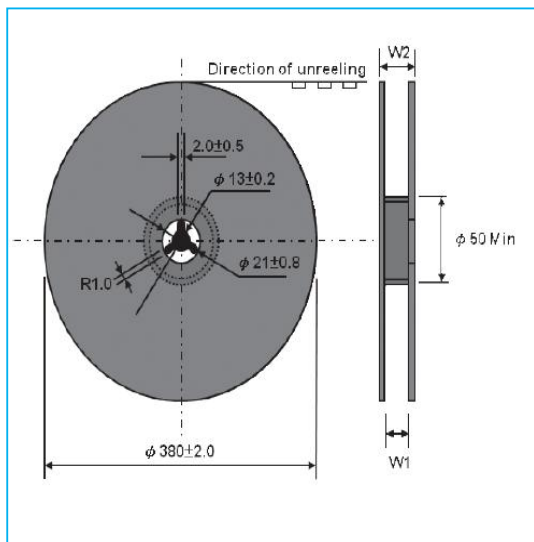

尺寸代码 Size code	W1 ±0.2 (mm)	W2 ±0.2 (mm)
5x5.8	18.0	22.0
6.3x8	18.0	22.0
8x12.5	26.0	30.0
10x10.5	26.0	30.0

5.3 胶带的方法和极性 Taping method and polarity

5.3.1 5、6、8 phi

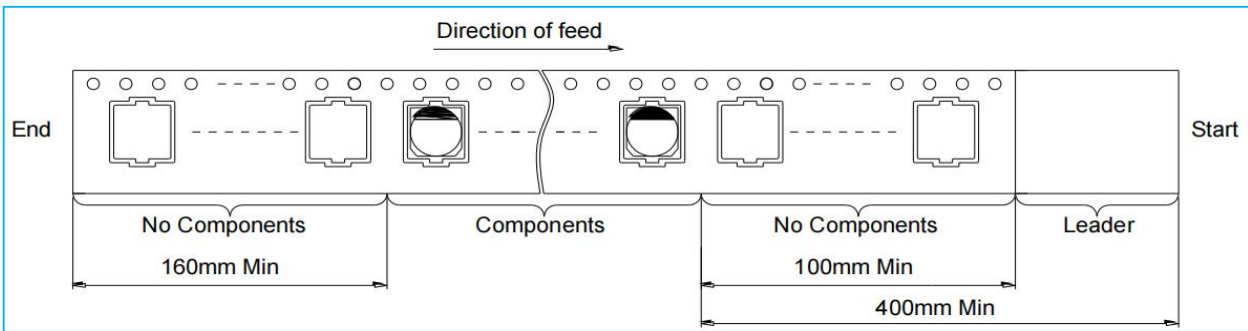

5.3.2 10 phi

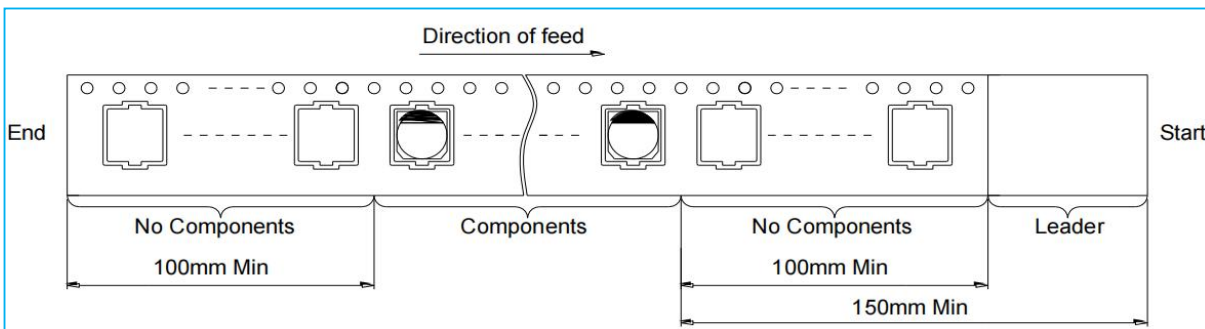

5. 印字 Marking

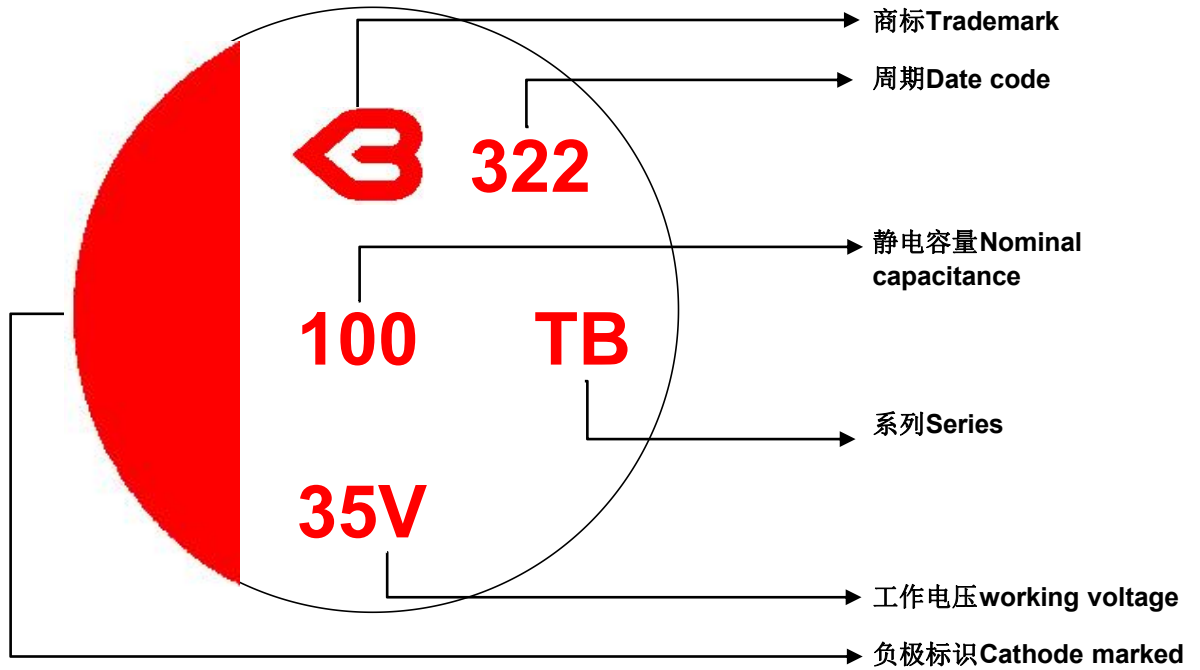

周期表示说明 Description of the date code

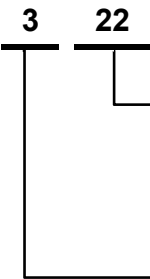

编码 Code	01	02	03	04	50	51	52
周别 Week	1	2	3	4	50	51	52

编码 Code	1	2	3	4	5	6	7	8
年份 Year	2021	2022	2023	2024	2025	2026	2027	2028

6. 产品结构图 Product Structure Diagram

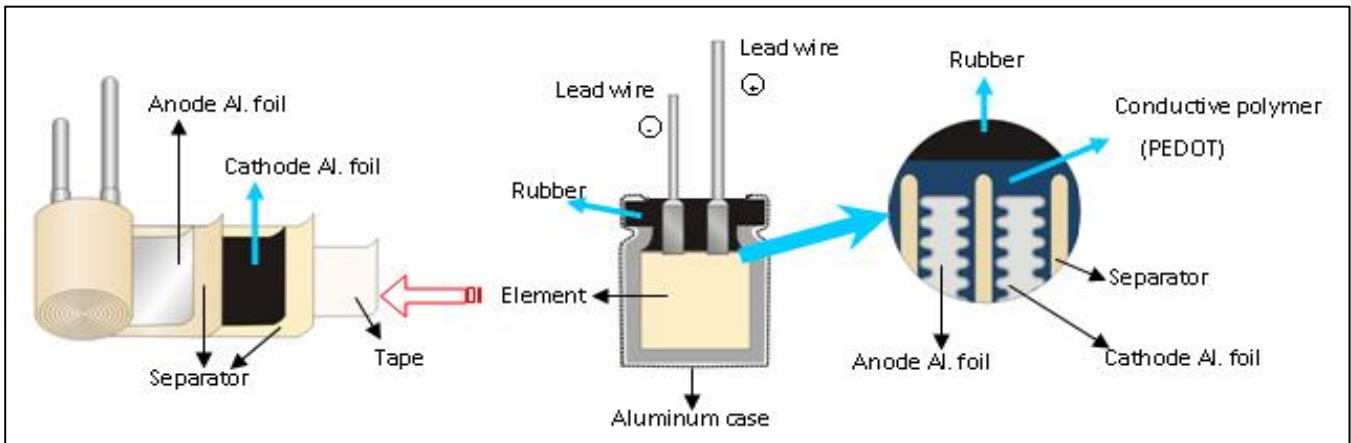

7. 电气特性 ELECTRICAL CHARACTERISTICS

7.1 条件说明

7.1.1 使用温度范围 Operating Temperature Range

使用温度范围是指电容在额定电压下可以稳定运行的环境温度范围

Operating temperature range is the range of ambient temperature at which the capacitor can be operated continuously at rated voltage.

7.1.2 特性 Characteristics

除非另有说明，标准的测量和测试环境条件如下：

Unless otherwise specified, the standard range of atmospheric conditions for making measurements and tests are as follows.

环境温度 Ambient temperature : 15 to 35°C

大气力压 Air pressure : 86kpa to 106kpa

若对结果有疑问，测试则按如下标准进行

If there may be doubt on the results, measurements shall be made within the following limits.

环境温度 Ambient temperature : 20±2°C

大气压 Air pressure : 86kpa to 106kpa

7.2 电性能 Electrical Characteristics

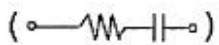
序号 No.	项目 Item	测试方法 Test method	性能 Performance
7.2.1	额定工作电压 Rated voltage	DC: 35 V	
7.2.2	电容量 Capacitance	测试频率 Measuring frequency : 120Hz 测试电路 Measuring circuit 	参考特性表 Refer to characteristic table
7.2.3	损耗角正切值 Dissipation Factor	等效串联电路 Series equivalent circuit 测试电压 Measuring voltage: 0.5Vrms or less 直流偏压 DC bias voltage : +1.5~2.0VDC	参考特性表 Refer to characteristic table
7.2.4	等效串联电阻 ESR	测试频率 Measuring frequency: 100kHz 测试温度 Measuring temperature: 20 ±2°C 测量位置: 不得超过导针焊点2mm。 Measuring point : 2mm max from the surface of a sealing resin on the lead wire	参考特性表 Refer to characteristic table

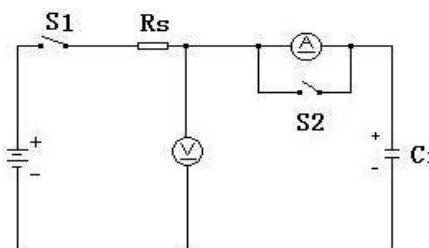
序号No.	项目Item	测试方法 Test method	性能 Performance
7.2.5	漏电流 Leakage current	<p>直流漏电流在20℃，有串联1000±100Ω电阻的情况下以直流工作电压且充电2min后测试 DC leakage current shall be measured after 2 minutes application of the DC rated working voltage through the 1000 Ω resistor at 20℃</p>  <p>Refer to characteristic table R : 1000±100Ω A : 电流表 DC current meter S1 : 开关 Switch S2 : 电流表保护开关 Switch for protect of current meter V: 电压表 DC voltage meter CX : 测试电容 Testing capacitor</p>	参考特性表 Refer to characteristic table

7.2.6	高温&低温性 Characteristics at High Temperature & Low Temperature	步骤 Step	温度(℃) Temperature	时间 (h) Time	测试项目 Measurement item	<p>Step 1: 容量、损失角在规格值内 Capacitance, tanδ shall meet the specified value 阻抗比率小于1.5 $Z (-55℃)/ Z (20℃)$ Less than 1.5</p> <p>Step 4: 漏电流 ≤ 规格值的150% Leakage current ≤ 150% of the initial specified value. 阻抗比率小于2.0 Z $(125℃)/ Z (20℃)$ Less than 2.0</p> <p>Step 5: 容差 ±5% Capacitance change : Within ±5% of step 1 损失角在规格值内 tanδ shall meet the specified value.</p>
		1	20±2	2	容量、损失角正切、阻抗 Capacitance, tanδ, Z	
		2	-55 ±2	2	容量、阻抗 Capacitance, Z	
		3	20±2	0.5	/	
		4	125 ±2	2	阻抗、漏电 Z , LC	
		5	20±2	2	容量、损失角正切 Capacitance, tanδ	
		备注Remarks: 120Hz: Capacitance, tanδ 100KHz: Z , ESR				

7.3 耐受能力 Endurance Performance

序号 No.	项目 Item	测试方法 Test method	性能 Performance
7.3.1	负荷寿命试验 Load Life Test	<p>电容在 125 ±2℃,加载直流电 4000 小时后,需在室温下放置2小时 才可进行测试。</p> <p>After 4000 hours continuous application of DC rated working voltage at 125 ± 2℃,the measurements shall be measured after 2 hours exposed at room temperature.</p>	<p>容量变化: 在初始值的±30%内 Capacitance change within ±30% of the initial value 损失角: 小于规格值的200% tan δ ≤ 200% of the initial specified value. 等效串联电阻≤规格值的200% ESR ≤ 200% of the initial specified value. 漏电流≤规格值 Leakage current ≤initial specified value. 外观: 没有明显的损伤 Appearance: No significant damage</p>
7.3.2	高温无负荷 Storage at high temperature	<p>最高温度中以1000±小时无负荷放置后, 常温常湿中放置16~24小时, 进行测定, 另对漏电流测定以下记电压处理为最佳。</p> <p>The capacitor shall be stored at temperature specified below for 1000±h,during which time no voltage shall be applied.And then the capacitor shall be subjected to standard atmospheric conditions for 16 to 24h,after which measurements shall be made.Prior to the measurement of leakage current, following conditioning may be made.</p> <p>温度: 最高使用温度±2℃ Temperature: Maximum operating temperature</p> <p>电压处理: 对电容器通过串联保护阻抗器(1KΩ), 加入30分直流额定电压后, 进行常温放电, 在常温常湿中放置24小时。</p> <p>Conditioning : The D.C.rated voltage shall be applied across the capacitor and it protective series resistor (1KΩ)for 30 min after which the capacitor shall be discharged.The capacitor shall than be subjected to standard atmospheric conditions for 24h.</p>	<p>漏电流≤规格值 Leakage current≤ specified value 容量改变在初始值的±30%内 Capacitance change within ±30% of initial value 损失角≤规格值的200% tanδ≤200% of the initial specified value. ESR≤规格值的200% ESR≤200% of the initial specified value.</p>
7.3.3	振动试验 Resistance to Vibration	<p>依照JIS C 5102 8.2和 JIS C 5025 To comply with JIS C 5102 8.2 and JIS C 5025 频率: 10到55Hz(1分钟间隔/10→55→10Hz) Frequency: 10 to 55Hz (1 minute interval/10→55→ 10Hz) 振幅: 0.75mm(整体偏移1.5mm) Amplitude : 0.75mm (Total excursion 1.5mm) 方向: X, Y, Z (3 轴) Direction : X, Y, Z (3 axes) 持续时间: 2小时/轴 (共6小时) Duration : 2 hours / axial (Total 6 hours)</p>	<p>容量在30 分钟内测量, 与初始值相比不应有较大的差异, 其改变在±5%以内 Capacitance value should not show drastic change compared to the initial capacitance when the value is measured within 30 minutes .Prior to the completion of exam, capacitance change</p>
7.3.4	可焊性 Solder ability	<p>温度: 235 ± 5 °C Temperature : 235 ± 5 °C 持续时间: 2 ± 0.5秒 Duration : 2 ± 0.5 seconds 焊料:25wt%的松香(JIS K5902)//乙醇(JIS K 8101) Flux:Rosin (JIS K5902)//Ethanol(JIS K8101); About 25 wt. %</p>	<p>容量在30 分钟内测量, 与初始值相比不应有较大的差异, 至少95%的浸渍表面覆盖有新的焊料 At least 95% of surface area of the dipped portion of the terminal shall be covered with new solder.</p>

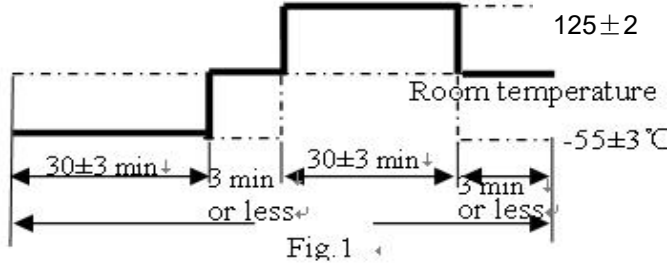
序号No.	项目Item	测试方法 Test method	性能 Performance
7.3.5	耐焊接热 Resistance to soldering heat	(1)焊料浴方法Solder bath method 温度Temperature : $260 \pm 5^{\circ}\text{C}$ 持续时间Duration : 10 ± 1 seconds 一直到间距为1.0mm的情况下 Until a distance of 1.0mm from the case. (2)Soldering iron method : 温度Temperature : $400 \pm 10^{\circ}\text{C}$ 持续时间Duration : $3+1/-0$ seconds	容量变化在初始值的 $\pm 5\%$ 内 Capacitance change: Within $\pm 5\%$ of initial capacitance 损失角 \leq 规格值的130% $\tan\delta \leq 130\%$ of the initial specified value. 等效串联电阻 \leq 规格值的130% ESR $\leq 130\%$ of the initial specified value. 漏电流 \leq 规格值 Leakage current \leq initial specified value.
7.3.6	稳态湿热 (恒稳态) Resistance to damp heat (steady state)	温度Temperature : $60 \pm 2^{\circ}\text{C}$ 相对湿度Relative humidity : 90% ~ 95% 持续时间Duration : 1000 (-0/+48) hrs 使用电压: 无负荷 Applied voltage : without load	电容变化在初始值的 $\pm 30\%$ 内 Capacitance change within $\pm 30\%$ of initial value 损失角 \leq 规格值的200% $\tan\delta \leq 200\%$ of the initial specified value. 等效串联电阻 \leq 规格值的200% ESR $\leq 200\%$ of the initial specified value. 漏电流 \leq 规格值 Leakage current \leq initial specified value.
7.3.7	快速变温 Rapid change of temperature	 <p>使用电压: 无负荷 Applied voltage : without load 循环次数: 5次 Cycle number : 5 Cycles 测试图: Fig. 1 Test diagram: Fig. 1</p>	容量变化: 在初始值的 $\pm 10\%$ 内 Capacitance change : Within $\pm 10\%$ of the initial capacitance 损失角: 小于或等于规格值 $\tan\delta \leq$ initial specified value. 漏电流 \leq 规格值 Leakage current \leq initial specified value.

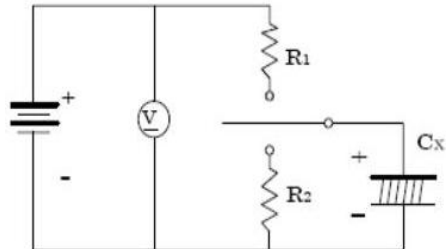
序号No.	项目Item	测试方法 Test method	性能 Performance												
7.3.8	浪涌电压 Surge voltage	<p>浪涌电压（额定电压×1.15）施加在360秒的循环中，包括充电30±5秒和放电330秒，在 125 ℃ 的1000次循环中，特性应满足右表</p> <p>After surge voltage(rated voltage×1.15) applied at a cycle of 360 seconds which consists charge for 30±5 seconds and discharge for 330 seconds, for 1000 cycles at 125 ℃, the characteristics shall meet right sheet.</p>	<p>容量改变在初始值的±30%内 Capacitance change within ±30% of initial value 损失角≤规格值的200% tanδ≤200% of the initial specified value. 阻抗≤规格值的200% ESR≤200% of the initial specified value. 漏电流≤规格值 Leakage current≤ specifiedvalue</p>												
		<div style="display: flex; align-items: center;">  <div style="margin-left: 20px;"> <p>V: DC voltmeter R1: Protective resistor 1kΩ R2: Discharging resistor 1kΩ Cx: Capacitor under test (10pcs)</p> </div> </div> <p>备注：若浪涌电压测试标准不能满足整机实际ON/OFF要求，请在样品阶段与我司RD确认，并将具体测试要求反馈给我司，包括测试电压、浪涌电流、充放频率、循环次数、测试温度及性能表现等。 Remark: If the surge voltage test standard is inconsistent with the actual ON/OFF requirements of the machine, Please confirm with our RD at the sample stage. And feedback the specific test requirements to our company, including test voltage, surge current, charge and discharge frequency, cycle times, test temperature and performance, etc.</p>													
7.3.9	端子强度 Terminal Strength	<p>测试方法 Test method</p> <p>端子抗拉强度： 沿电容器端子引线方向施加拉力（如下表），30±1s Tensile strength of termination: A static load (stated in the table below) shall be applied to the terminal in the axial direction and acting in a direction away from the body for 30±1sec.</p>	<p>测静电容量时，无接触不良，断线及短路。另，无端子的破损等机械损伤。 When the capacitance is measured. There shall be no intermittent contacts, or open or short-circuiting. There shall be no such mechanical damage as terminal damage etc.</p>												
		<table border="1" style="width:100%; border-collapse: collapse; text-align: center;"> <tr> <td style="width:15%;">引线直径Φ (mm)</td> <td>0.45</td> <td>0.50</td> <td>0.60</td> <td>0.80</td> <td>1.00</td> </tr> <tr> <td>拉力 (N)</td> <td>5</td> <td>5</td> <td>10</td> <td>10</td> <td>25</td> </tr> </table>		引线直径Φ (mm)	0.45	0.50	0.60	0.80	1.00	拉力 (N)	5	5	10	10	25
		引线直径Φ (mm)		0.45	0.50	0.60	0.80	1.00							
		拉力 (N)		5	5	10	10	25							
<p>端子抗弯强度：在电容器引线施加固定重力（如下表），然后将电容器弯折 90°后回到原位，再向相反方向弯折90°后回到原位。上述过程在5秒内完成。 Bending strength of termination: Hang the specified dead weight (stated in the table below), then bent the body through 90°, return to the original position. Next bent it in opposite direction through 90° with the same speed, again return to the original position. Carry out this operation in about 5 sec.</p>															
<table border="1" style="width:100%; border-collapse: collapse; text-align: center;"> <tr> <td style="width:15%;">引线直径Φ (mm)</td> <td>0.45</td> <td>0.50</td> <td>0.60</td> <td>0.80</td> <td>1.00</td> </tr> <tr> <td>拉力 (N)</td> <td>2.5</td> <td>2.5</td> <td>5</td> <td>5</td> <td>10</td> </tr> </table>	引线直径Φ (mm)	0.45	0.50	0.60	0.80	1.00	拉力 (N)	2.5	2.5	5	5	10			
引线直径Φ (mm)	0.45	0.50	0.60	0.80	1.00										
拉力 (N)	2.5	2.5	5	5	10										

8.焊接条件 ELECTRICAL CHARACTERISTICS

8.1 回流焊条件（仅限于SMD产品或有高温回流焊要求的DIP产品）

Reflow soldering conditions (limited to SMD products or DIP products with high temperature reflow soldering requirements)

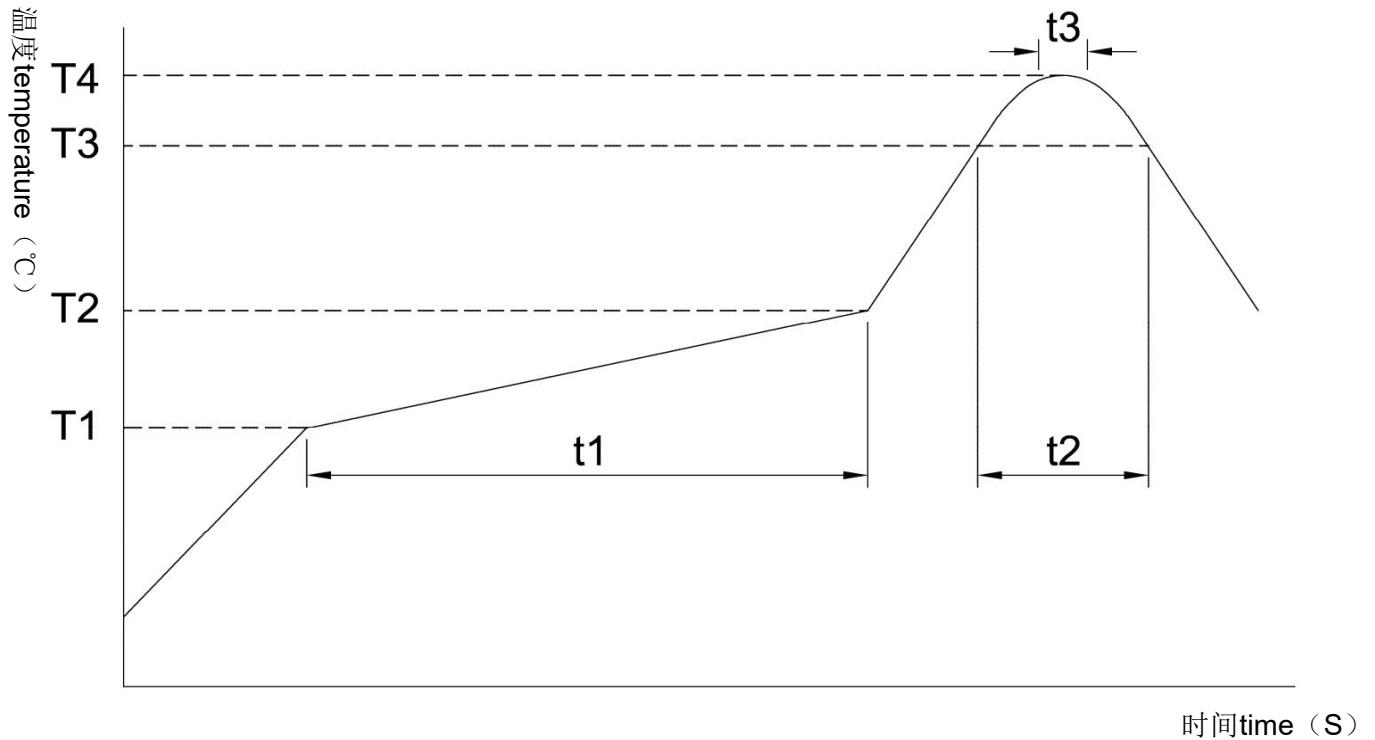

产品类别 product category		高分子固态电容器 Solid		高分子固液混合电容器 Hybrid		
预热 Preheat	温度temperature (T1~T2, °C)	150~200		150~180		
	时间time (t1) (最大max, S)	180		120		
持续时间 duration	温度temperature (T3, °C)	230		200	217	230
	时间time (t2) (最大max, S)	60		70	50	40
最高温度 Highest temperatures	温度temperature (T4, °C)	250	260	250	260	
	时间time (t3) (最大max, S)	5		5		
回流焊次数 The number of reflow		2	1	2	1	

8.2 以铬铁焊锡时请依循下列条件作业：

When soldering with ferrochromium, please follow the following conditions

* 铬铁最高温度：350 ± 5°C

*Maximum temperature of ferrochromium: 350 ± 5 °C

* 焊接时间：3 +1 / -0 秒

* Welding time: 3 +1 / -0 seconds

9. 操作注意事项 Operating Precautions

9.1 极性 Polarity

Beryl CAP是具有正负极的导电高分子混合铝电解电容，使用中不可反接，若接反，则电容会因为漏电流不断增大或短路而造成寿命缩短。

Beryl CAP is a Polymer Hybrid aluminum electrolytic capacitor with positive and negative electrodes. Do not reverse the polarity when using. If it is used with the polarities reversed, its life may shorten because of increasing leakage current or short circuit.

9.2 禁止电路 Prohibited circuits

因为焊接及其它动作可造成电容的漏电流增加，BerylCAP不可使用在下列电路中：

Since problems can be expected due to leakage current increasing during soldering and other processes, BerylCAP cannot be used in the following circuits

- 1)高阻抗电路 1) High impedance circuits;
- 2)耦合电路 2) Coupling circuits;
- 3)时限恒量电路 3) Time constant circuits;
- 4)为提高耐电压而串联两个或多个电容于电路中
4) Connection of two or more capacitors in series for higher withstand voltage;
- 5)电路因漏电流过大而有坏的影响 5) Circuits to get bad influence by big leakage current

* 除漏电流的波动上升外，电容的使用条件如在承认书中规定的高温和低温，温湿和耐受性条件都会影响电容量。若电容作为时限恒量电容使用，因其对电容量的变动的敏感性，电容量的改变会造成影响。不要将其作为时限恒量电容使用，同时若因电压原因要串联多个BerylCAP电容，请联系肇庆绿宝石电子科技股份有限公司。

* In addition to the leakage current fluctuation above, the operational conditions such as characteristics at high and low temperature, damp heat and endurance stipulated in the specifications will affect the capacitance. The fluctuation of the capacitance may cause problem if it is used as a time constant capacitor, which is extremely sensitive to the fluctuation of the capacitance. Do not use it as a time constant capacitor. Additionally, please contact ZhaoQing Beryl Electronic Technology Co., Ltd. for usage of two or more BerylCAP in series for voltage proof.

9.3 电压 Over voltage

电压若超过额定电压，即便只是一瞬间也可能造成短路

Over voltage exceeding the rated voltage may not be applied even for an instant as it may cause a short circuit.

9.4 快速充放电 Rapid charge and discharge

快速充放电是不适用的（为了维持高的可靠性）。若充放瞬间电流超过10A或10倍允许纹波电流超过10A，为防止快速的充放电造成电容短路、漏电增大及容量衰减，电路中应加上一个保护电路用以分流过大的电流，用保护电路。

Rapid charging and discharging is unsuitable (for maintenance of high-proof reliability). If the instantaneous current of charging and discharging is more than 10A or 10 times of the allowable ripple current is more than 10A, in order to prevent the capacitor from short circuit, leakage increase and capacity reduction caused by rapid charging and discharging, a protection circuit shall be added to the circuit to reduce the excessive current.

9.5 焊接注意事项 Considerations when soldering

焊接条件要在承认书的规定范围内。若没有遵守承认书的条件，则电容漏电流可能急剧增加，容量衰减。

The soldering conditions are to be within the range prescribed in specifications. If the specifications are not followed, there is a possibility of the cosmetic deflection, the intensive increase of leakage current, and the capacitance reduction.

使用需知 Things to be noted before mounting.

(a) 已安装过的或加过电压的BerylCAP请勿再使用。经历了周期性电性能测试的BerylCAP不可再用。

(a) Do not reuse BerylCAP that have been assembled in a set and energized. Excluding BerylCAP that have been removed for measuring electrical characteristics during a periodic inspection, BerylCAP cannot be reused

(b) BerylCAP贮藏一年时间后，漏电流可能会增大，使用前，请在105℃，额定电压及接有1 kΩ电阻的条件下充电2小时。

(b) Leakage current may increase when BerylCAP are stored for one year. In this case, apply rated voltage for 2 hour at 105℃ with load of 1 kΩ resistor.

(c) 回流焊接 Reflow soldering

插件型产品不适用于回流焊接作业。若需进行回流焊作业，请先联系肇庆绿宝石电子科技股份有限公司

Do not apply radial lead type capacitors to reflow soldering. If reflow soldering is required, please contact ZhaoQing Beryl Electronic Technology Co., Ltd.

(d) 焊接后处理 Handling after soldering

在这之后，不要倾斜，弯曲或扭曲BerylCAP Do not tilt, bend or twist the BerylCAP after it

不可通过抓捏BerylCAP来移动印刷电路板 Do not move the PCB with catching BerylCAP itself.

堆叠印刷电路板时确保BerylCAP没有碰到其它电路板或部件

When stacking PCB make sure that the BerylCAP does not touch other PCB or components.

不可将BerylCAP与其它物品堆放 Do not dump the BerylCAP with objects.

9.6 贮存 Storage

1) 请将BerylCAP贮存于温度在5to 35℃之间，相对湿度在75%以下的没有阳光直射的环境中，如果可能可贮存于包裹中。

(如果在35到85℃，他应该少于三个月)

1) Store BerylCAP with the temperature range between 5to 35℃ (If between 35 to 85℃, it should be less than three months), and the relative humidity of 75% or less without direct sunshine and store BerylCAP in the package states if possible.

2) BerylCAP请在使用前再打开包装袋并且快速用完。

BerylCAP are recommended that you shall open the bag just before use and BerylCAP shall be used up.

3) 不要在有水、盐水、油及凝结状况的地方贮存BerylCAP

Never store BerylCAP in which it is directly exposed to water, brine, oil or in condensation status.

4) 禁止在含有毒气体的区域放置BerylCAP (如：硫化氢、亚硫酸、亚硝酸、氯气、氨水等)

Never store BerylCAP in any area filled with poisonous gases (including hydrogen sulfide, sulfurous acid, nitrous acid, chlorine and ammonia).

5)禁止在有紫外线或放射性辐射的区域放置 BerylCAP。

Never store BerylCAP in any area to which ultraviolet and/or radial rays are radiated.

6) 存储时间 storage time

NO	物料名称 Material Name	有效保存期限 (开启包装前) "Valid Shelf Life (before unpacking)"	有效保存期限 (开启包装后) "Valid Shelf Life (after unpacking)"	超过有效保存期限处理方式 Handling Method for Exceeding the Valid Storage Period	最大保存期限 Maximum Shelf Life	超过最大保存期限处 理方式 Handling Method for Exceeding the Maximum Storage Life
1	固态电容器插件胶袋包装 Solid Capacitor Radial Lead Type Plastic Bag Packaging	36个月 Thirty-six months	7天 Seven Days	转入“逾期品仓库”出货前先作重工处理，任何一项参数判定NG作正常报废处理，参数OK依正常流程出货 Before transferring to the "overdue product warehouse", rework should be done before shipment. Any parameter is judged as NG for normal scrapping, and if the parameter is OK, the product will be shipped according to the normal process.	3年 3 Years	报废处理 Scrap Disposal
2	固态电容器插件编带 Solid Capacitor Radial Lead Type Tape Packaging	24个月 Twenty-four months	7天 Seven Days			
3	固态电容器表面贴装 Solid Capacitor SMD Packaging	24个月 Twenty-four months	30天 Thirty Days			

9.7 清洗 Cleaning

关于HCFC，可用高浓酒精，石油，匝烯，水和表面活性剂以及别的溶剂（单独或混合使用）浸泡，用超声波，煮沸，蒸发等方法按制作者的建议清洗。更多详情请联系。

Concerning about HCFC, higher alcohol system, petroleum system, terpene system, water system with surface active agent and other solvents the washing way (separateness or combinations) by soak, ultrasonic wave, boil, vapor etc. is confirmed under the maker's recommendation. Please contact us if you require further details.

对于构成部品的材料，处理的注意事项 NOTICE ON MANUFACTURING PROCESS

●记载内容不变更而添加 ●Don't change written contents and append it.

- 1.此部品不使用含有RoHS的指定物质.
- 2.对于RoHS物质使用的有无在承认书上要明确规定.
- 3.为部品易区分处理. 对塑胶材料要标识材料记号

所谓标识记号详细请参照RoHS[塑胶制部品的材料标识规定]

但, 标识困难时排除.

[困难例]

- . 无记入标识记号的场所.
 - . 因要记入标识可能会造成机能损坏.
 - . 因生产方法标识困难.
- 4.成型用树脂. 油墨, 涂料, 覆盖电线要从绿色环保伙伴认定厂商购买.

1.This part should not contain any substances which are specified in RoHS

2.Clarify by delivery specifications about the existence of use of the substance which are specified in RoHS

3.In order to make sorting of plastic waste easy, material symbols is marked on the plastic part

For details on marking symbols, refer to RoHSMarking of plastic parts and packaging material".

Marking may be omitted in the following cases:

- . Not enough space to apply the marking
- . Marking would interfere with performance or functional requirements
- . Marking technically not feasible due to the specific production method

4.Purchase ink, paint,wire rods. And molding resins only from the business partners that Sony approves as Green Partners.

11.包装.Packing

11.1包装标签内容 Packing Label Marked (the following items shall be marked on the label)

(Inside box or bag)

- | | | | |
|-------------|------------|---------|-----------|
| (1)客户订单号码 | (2)客户料号 | (3)本厂料号 | (4)产品容量 |
| (5)产品电压 | (6)产品尺寸 | (7)包装数量 | (8)产品容量范围 |
| (9)QC检验印章处. | (10)产品生产批号 | | |

批号的填写 LOT Number :

12	34	56	7 8 9 10
↓	↓	↓	↓
年份	月份	日期	生产序号
year	month	date	number

11.2贴片产品包装 Patch-type braided tape specification

尺寸Case size D*L(mm)	卷 reel (pcs)	内盒 Inner box (pcs)	外箱 Outer carton (pcs)	内盒Inner box L*W*H (mm)	外箱Outer carton L*W*H (mm)
Φ5*5~6	1200	6000	12000	383*383*92	395*395*199
Φ5*6.5~7	1000	5000	10000	383*383*92	395*395*199
Φ5*7.5~8	900	4500	9000	383*383*92	395*395*199
Φ5*8.5~11.5	800	4000	8000	383*383*92	395*395*199
Φ5*12~13	500	1500	3000	383*383*92	395*395*199
Φ6.3*5.7~6.5	1000	5000	10000	383*383*92	395*395*199
Φ6.3*7~8.5	800	4000	8000	383*383*92	395*395*199
Φ6.3*9~11.5	600	3000	6000	383*383*92	395*395*199
Φ6.3~6.5*12~13	500	2500	5000	383*383*92	395*395*199
Φ6.3*15~17	300	900	1800	383*383*92	395*395*199
Φ8*7.5~9.7	500	1500	3000	383*383*110	395*395*235
Φ8*10~12.5	500	1500	3000	383*383*110	395*395*235
Φ8*15~17	300	900	1800	383*383*110	395*395*235
Φ10*8~11.5	400	1200	2400	383*383*110	395*395*235
Φ10*12~12.5	400	1200	2400	383*383*110	395*395*235

X-ON Electronics

Largest Supplier of Electrical and Electronic Components

Click to view similar products for [Aluminium Electrolytic Capacitors - SMD category](#):

Click to view products by [BERYL manufacturer](#):

Other Similar products are found below :

[ULV2H4R7MNL1GS](#) [ULV2H1R8MNL1GS](#) [MAL214099813E3](#) [CA025M4R70REB-0405](#) [UCX1V471MNQ1MS](#) [10SVP120M](#)
[DV100M050C055ETR](#) [RVJ-50V101MH10U-R](#) [AEH1012471M016R](#) [MAL213967339E3](#) [GVT1C337M0608CNVC](#) [EMK1EM331FB0D00R](#)
[EMF1CM221FB0D00R](#) [EMF1CM331FB0D00R](#) [EMF1CM471FB0D00R](#) [EMK1JM101GB0D00R](#) [EMK1AM102GB0D00R](#)
[EMK1HM221GB0D00R](#) [DV221M6R3E055ETR](#) [DV221M025E077ETR](#) [RV331M025F105ETR](#) [RVT1A101M0505](#) [GVZ1H101M0607](#)
[CK1E100M0405](#) [GVM1E331M0607](#) [VT10UF100V167RV0127](#) [VT100UF16V167RV0124](#) [CS100UF35V167RV0155](#)
[CK220UF16V167RV0142](#) [VT10UF16V167RV0128](#) [VT22UF35V167RV0131](#) [CS470UF10V167RV0150](#) [CK100UF16V167RV0138](#)
[CK220UF10V167RV0141](#) [RVT330UF25V167RV0055](#) [VT470UF16V167RV0135](#) [CS100UF10V167RV0144](#) [126RV0017](#)
[VT47UF35V167RV0137](#) [CS220UF35V167RV0148](#) [126RV0010](#) [126RV0009](#) [VT220UF25V167RV160](#) [VT220UF16V167RV0088](#)
[126RV0012](#) [126RV0011](#) [126RV0013](#) [126RV0018](#) [126RV0008](#) [126RV0015](#)