



# 规格书 SPECIFICATION SHEET

Customer name: \_\_\_\_\_

BERYL SERIES: RC TYPE: RADIAL

DESCRIPTION: 15uF/400V Φ10\*13

Apply date : 2022-04-12

BERYL			CUSTOMER		
P/N:RC400M150LO10*13TH-2A1Et			P/N:		
PREPARED	CHECKED	APPROVAL	PREPARED	CHECKED	APPROVAL
董桂茹	廖梅君 	张业维			

After approved, please sign back 1 Approval Sheet before order. If not, we will treat it as tacitly acknowledged and accepted our relative standard and technical index.

**Zhao Qing Beryl Electronic Technology Co., Ltd.**

TEL: (0758) 13428556686 FAX: (0758) 2862870

E-mail: master@zq-beryl.com <http://www.zq-beryl.com>

NO.8 DUANZHOU ROAD, ZHAOQING CITY. GUANGDONG. CHINA



## 1、Application

This specification applies to Aluminum electrolytic capacitor (foil type) used in electronic equipment.  
Designed capacitor's quality meets IEC 60384.

## 2、Table of specification and characteristics

Series	Cap(uF) 120Hz/20°C	WV(V)	Size(mm)		Temperature (°C)	Capacitance Tolerance	Life(hours) @105(°C)	
			D	L				
RC	15	400	10	13	-40~ +105	±20%	5000	
DF (%) (MAX) 120Hz/20°C		LC(μA) (MAX) 2 min/20°C		ESR(Ω) (MAX) 100KHz/25°C		RC (mA rms) (MAX)105°C/100KHz		Surge voltage(V)
≤20		≤130		-		398		440

Other: /

## 3、Product Dimensions

Type

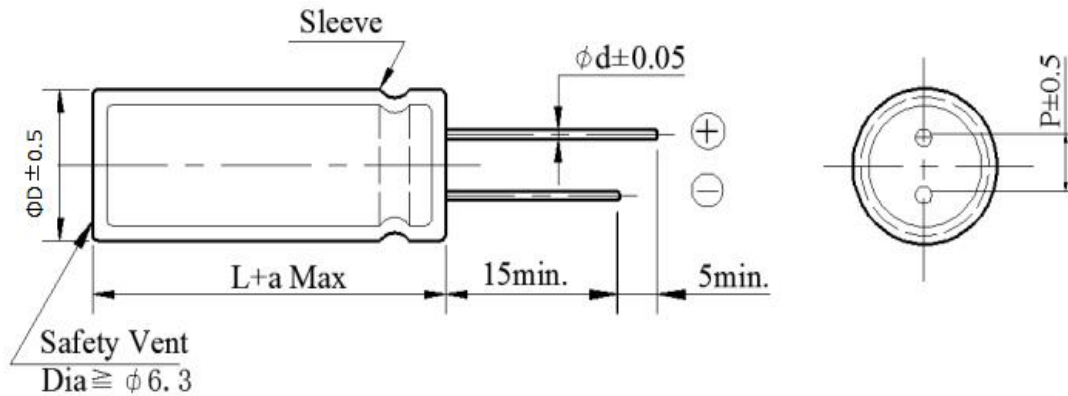

$\Phi D$	5	6.3	8	10	13	16	18	22
P	2	2.5	3.5	5	5	7.5	7.5	10
$\Phi d$	0.5	0.5	0.5/0.6	0.6	0.6	0.8	0.8	0.8
a	(L < 20) ± 1.5				(L ≥ 20) ± 2.0			

## 4、Part Number

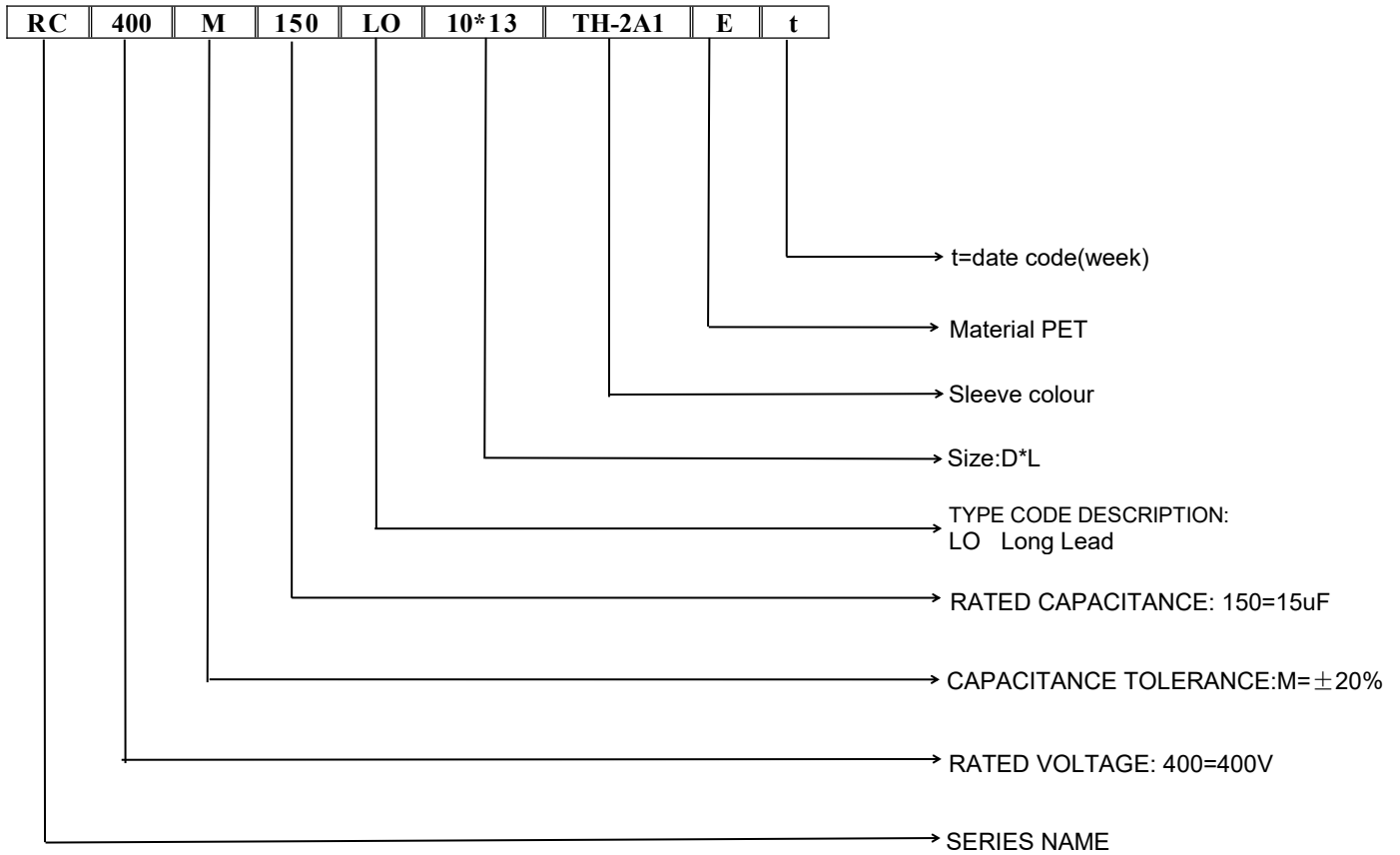

## 5、Construction

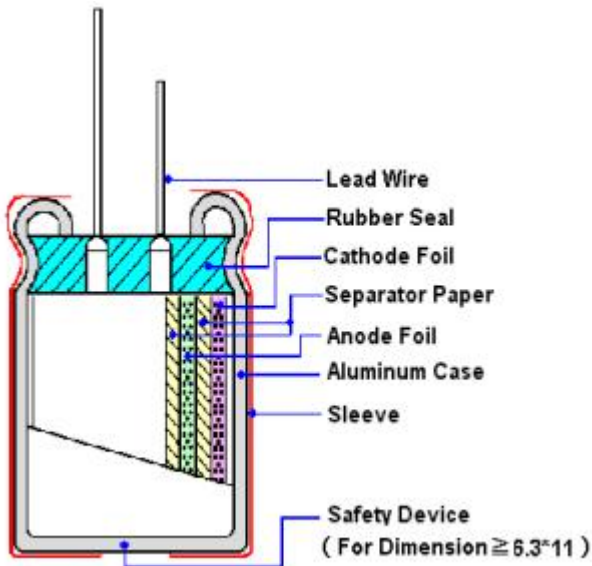

Material name	Composition	Supplier name
Lead	Al and (Fe+Cu+Sn)	NM、JX
Rubber	EPT / IIR	LHX、LA、TH、LM2
Case	Aluminum	OX、YJ、HL、LY2
Paper	Wood / Fibrous plant materials	KE、DF
Anode foil	Al + Al <sub>2</sub> O <sub>3</sub>	HY1、HY2、HF、HY3、LD、FQ
Cathode foil	Aluminum	GY、LY1
Electrolyte	Glycol + Water + Ammonium salt	XZB、LM1、JZ2、FS
Sleeve	PET	YL、CY

## 6、Product Marking

### Marking Sample:

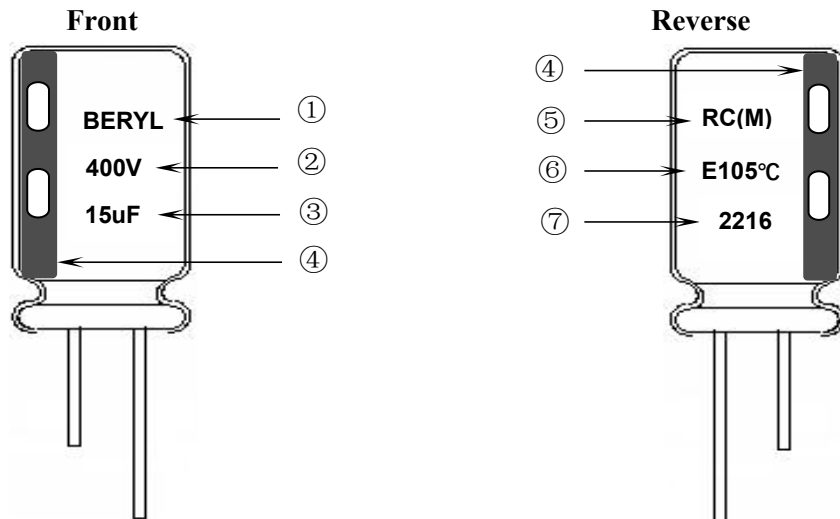

### Marking Details:

Capacitor shall be marked the following items:

- 1) Trademark (BERYL)
- 2) working voltage(400V)
- 3) Nominal capacitance(15uF)
- 4) Cathode marked
- 5) Series symbol & Nominal capacitance tolerance (M: -20% ~ +20%)
- 6) Sleeve material(E: PET)

Maximum operating temperature(105°C)

- 7) Date code (2216)

22: Manufactured year 2022

Code	19	20	21	22	23	24	25	26	.....
Year	2019	2020	2021	2022	2023	2024	2025	2026	.....

16: Manufactured week (01、02、03、04.....52、53)

## 7、Characteristics

### Standard atmospheric conditions

Unless other specified, the standard range of atmospheric conditions for making measurements and tests is as follows:

Ambient temperature : 15°C to 35°C

Relative humidity : 45% to 85%

Air pressure : 86kPa to 106kPa

If there is any doubt about the results, measurement shall be made within the following conditions:

Ambient temperature : 20°C ± 2°C

Relative humidity : 60% to 70%

Air pressure : 86kPa to 106kPa

### Operating temperature range

The ambient temperature range at which the capacitor can be operated continuously at rated voltage is (6.3~450WV) -40°C to +105°C .

**Table**

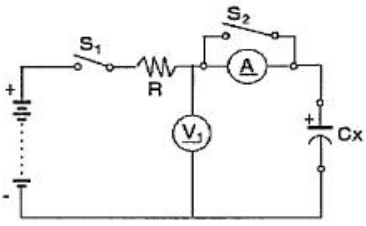
ITEM		PERFORMANCE
1	Nominal capacitance (Tolerance)	<p>&lt;Condition&gt;            Measuring Frequency: 120Hz±12Hz            Measuring Voltage: Not more than 0.5V<sub>rms</sub> +1.5~2.0V.DC            Measuring Temperature: 20±2°C</p> <p>&lt;Criteria&gt;            Shall be within the specified capacitance tolerance.</p>
2	Leakage current	<p>&lt;Condition&gt;            Connecting the capacitor with a protective resistor (1kΩ±10Ω) in series for 2 minutes, and then, measure leakage current.</p> <p>&lt;Criteria&gt;            I: Leakage current (μA)  <math>I (\mu A) \leq 0.02CV + 10 (\mu A)</math>            measurement circuit refer to right drawing.            C: Capacitance (μF)            V: Rated DC working voltage (V)</p> 
3	Dissipation factor	<p>&lt;Condition&gt;            Nominal capacitance, for measuring frequency, voltage and temperature.</p> <p>&lt;Criteria&gt;            Must be within the parameters (See page 3)</p>

ITEM		PERFORMANCE																												
4	<b>Impedance</b>	<p><b>&lt;Condition&gt;</b>            Measuring frequency:100kHz; Measuring temperature:20±2°C            Measuring point: 2mm max. from the surface of a sealing rubber on the lead wire.</p> <p><b>&lt;Criteria&gt;</b>            (20°C) Must be within the parameters (See page 3)</p>																												
5	<b>Load life test</b>	<p><b>&lt;Condition&gt;</b>            According to IEC60384-4No. 4.13 methods, the capacitor is stored at a temperature of Maximum operating temperature ±2°C with DC bias voltage plus the rated ripple current for Rated life +48/0hours. (The sum of DC and ripple peak voltage shall not exceed the rated working voltage) Then the product should be tested after 16 hours recovering time at atmospheric conditions. The result should meet the following table:</p> <p><b>&lt;Criteria&gt;</b>            The characteristic shall meet the following requirements.</p> <table border="1" style="width: 100%; border-collapse: collapse;"> <tr> <td style="width: 40%;">Leakage current</td> <td>Not more than the specified value.</td> </tr> <tr> <td>Capacitance Change</td> <td>Within ±20% of initial value.</td> </tr> <tr> <td>Dissipation Factor</td> <td>Not more than 200%of the specified value.</td> </tr> <tr> <td>Appearance</td> <td>There shall be no leakage of electrolyte.</td> </tr> </table>	Leakage current	Not more than the specified value.	Capacitance Change	Within ±20% of initial value.	Dissipation Factor	Not more than 200%of the specified value.	Appearance	There shall be no leakage of electrolyte.																				
Leakage current	Not more than the specified value.																													
Capacitance Change	Within ±20% of initial value.																													
Dissipation Factor	Not more than 200%of the specified value.																													
Appearance	There shall be no leakage of electrolyte.																													
6	<b>Shelf life test</b>	<p><b>&lt;Condition&gt;</b>            The capacitors are then stored with no voltage applied at a temperature of Maximum operating temperature±2°C for1000+48/0 hours. Following this period, the capacitors shall be removed from the test chamber and be allowed to stabilized at room temperature for16 hours. measure leakage current</p> <p><b>&lt;Criteria&gt;</b>            The characteristic shall meet the following requirements.</p> <table border="1" style="width: 100%; border-collapse: collapse;"> <tr> <td style="width: 40%;">Leakage current</td> <td>Not more than 200% of the specified value</td> </tr> <tr> <td>Capacitance Change</td> <td>Within ±20% of initial value.</td> </tr> <tr> <td>Dissipation Factor</td> <td>Not more than 200%of the specified value.</td> </tr> <tr> <td>Appearance</td> <td>There shall be no leakage of electrolyte.</td> </tr> </table>	Leakage current	Not more than 200% of the specified value	Capacitance Change	Within ±20% of initial value.	Dissipation Factor	Not more than 200%of the specified value.	Appearance	There shall be no leakage of electrolyte.																				
Leakage current	Not more than 200% of the specified value																													
Capacitance Change	Within ±20% of initial value.																													
Dissipation Factor	Not more than 200%of the specified value.																													
Appearance	There shall be no leakage of electrolyte.																													
7	<b>Maximum permissible (ripple current, temperature coefficient)</b>	<p><b>&lt;Condition&gt;</b>            The maximum permissible ripple current is the maximum A.C current at 100kHz and can be applied at maximum operating temperature            Table-3            The combined value of D.C voltage and the peak A.C voltage shall not exceed the rated voltage and shall not reverse voltage.</p> <p><b>Frequency Multipliers:</b></p> <table border="1" style="width: 100%; border-collapse: collapse;"> <tr> <td style="width: 15%;"></td> <td style="width: 15%;">Freq (Hz)</td> <td style="width: 15%;">120</td> <td style="width: 15%;">1k</td> <td style="width: 15%;">10k</td> <td style="width: 15%;">100k</td> </tr> <tr> <td style="width: 15%;">Cap. (µF)</td> <td style="width: 15%;"></td> <td style="width: 15%;"></td> <td style="width: 15%;"></td> <td style="width: 15%;"></td> <td style="width: 15%;"></td> </tr> <tr> <td style="width: 15%;">15</td> <td style="width: 15%;"></td> <td style="width: 15%;">0.50</td> <td style="width: 15%;">0.73</td> <td style="width: 15%;">0.92</td> <td style="width: 15%;">1.00</td> </tr> </table> <p><b>Temperature Coefficient:</b></p> <table border="1" style="width: 100%; border-collapse: collapse;"> <tr> <td style="width: 40%;">Temperature (°C)</td> <td style="width: 10%;">60</td> <td style="width: 10%;">85</td> <td style="width: 10%;">95</td> <td style="width: 10%;">105</td> </tr> <tr> <td style="width: 40%;">Factor</td> <td style="width: 10%;">2.23</td> <td style="width: 10%;">1.73</td> <td style="width: 10%;">1.41</td> <td style="width: 10%;">1.00</td> </tr> </table>		Freq (Hz)	120	1k	10k	100k	Cap. (µF)						15		0.50	0.73	0.92	1.00	Temperature (°C)	60	85	95	105	Factor	2.23	1.73	1.41	1.00
	Freq (Hz)	120	1k	10k	100k																									
Cap. (µF)																														
15		0.50	0.73	0.92	1.00																									
Temperature (°C)	60	85	95	105																										
Factor	2.23	1.73	1.41	1.00																										

ITEM		PERFORMANCE																																										
8	Terminal strength	<p><b>&lt;Condition&gt;</b>            Tensile strength of terminals            Fixed the capacitor, applied force to the terminal in lead out direction for 30+5-0 seconds. Bending strength of terminals.            Fixed the capacitor, applied force to bent the terminal (1~4 mm from the rubber) for 90° within 2~3 seconds, and then bent it for 90° to its original position within 2~3 seconds.</p> <table border="1"> <thead> <tr> <th>Diameter of lead wire</th> <th>Tensile force N (kgf)</th> <th>Bending force N (kgf)</th> </tr> </thead> <tbody> <tr> <td>0.5mm and less</td> <td>5 (0.51)</td> <td>2.5 (0.25)</td> </tr> <tr> <td>0.6~0.8 mm</td> <td>10 (1.02)</td> <td>5 (0.51)</td> </tr> </tbody> </table> <p><b>&lt;Criteria&gt;</b>            No noticeable changes shall be found, no breakage or looseness at the terminal.</p>	Diameter of lead wire	Tensile force N (kgf)	Bending force N (kgf)	0.5mm and less	5 (0.51)	2.5 (0.25)	0.6~0.8 mm	10 (1.02)	5 (0.51)																																	
Diameter of lead wire	Tensile force N (kgf)	Bending force N (kgf)																																										
0.5mm and less	5 (0.51)	2.5 (0.25)																																										
0.6~0.8 mm	10 (1.02)	5 (0.51)																																										
9	Temperature characteristics	<p><b>&lt;Condition&gt;</b></p> <table border="1"> <thead> <tr> <th>STEP</th> <th>Testing temperature (°C)</th> <th>Time</th> </tr> </thead> <tbody> <tr> <td>1</td> <td>20±2</td> <td>Time to reach thermal equilibrium</td> </tr> <tr> <td>2</td> <td>-40 -25±3</td> <td>Time to reach thermal equilibrium</td> </tr> <tr> <td>3</td> <td>20±2</td> <td>Time to reach thermal equilibrium</td> </tr> <tr> <td>4</td> <td>105±2</td> <td>Time to reach thermal equilibrium</td> </tr> <tr> <td>5</td> <td>20±2</td> <td>Time to reach thermal equilibrium</td> </tr> </tbody> </table> <p>Capacitance, DF, and impedance shall be measured at 120Hz.</p> <p><b>&lt;Criteria&gt;</b></p> <p>a. At +105°C, capacitance measured at +20°C shall be within ±25% of its original value.            Dissipation factor shall be within the limit of Item 7.3            The leakage current measured shall not more than 10 times of its specified value.</p> <p>b. In step 5, capacitance measured at +20°C shall be within ±10% of its original value.            Dissipation factor shall be within the limit of Item 7.3            The leakage current shall not more than the specified value.</p> <p>c. At -40°C, Impedance (Z) ratio shall not exceed the value of the following table.</p> <table border="1"> <thead> <tr> <th>Voltage (V)</th> <th>6.3</th> <th>10</th> <th>16</th> <th>25</th> <th>35</th> <th>50</th> <th>63</th> <th>100</th> <th>160</th> <th>200~400</th> <th>450</th> </tr> </thead> <tbody> <tr> <td>Z-40°C/Z+20°C</td> <td>8</td> <td>6</td> <td>4</td> <td>4</td> <td>4</td> <td>4</td> <td>4</td> <td>4</td> <td>4</td> <td>7</td> <td>8</td> </tr> </tbody> </table>	STEP	Testing temperature (°C)	Time	1	20±2	Time to reach thermal equilibrium	2	-40 -25±3	Time to reach thermal equilibrium	3	20±2	Time to reach thermal equilibrium	4	105±2	Time to reach thermal equilibrium	5	20±2	Time to reach thermal equilibrium	Voltage (V)	6.3	10	16	25	35	50	63	100	160	200~400	450	Z-40°C/Z+20°C	8	6	4	4	4	4	4	4	4	7	8
STEP	Testing temperature (°C)	Time																																										
1	20±2	Time to reach thermal equilibrium																																										
2	-40 -25±3	Time to reach thermal equilibrium																																										
3	20±2	Time to reach thermal equilibrium																																										
4	105±2	Time to reach thermal equilibrium																																										
5	20±2	Time to reach thermal equilibrium																																										
Voltage (V)	6.3	10	16	25	35	50	63	100	160	200~400	450																																	
Z-40°C/Z+20°C	8	6	4	4	4	4	4	4	4	7	8																																	
10	Surge test	<p><b>&lt;Condition&gt;</b>            Applied a surge voltage to the capacitor connected with a (100 ±50)/CR (kΩ) resistor in series for 30±5 seconds in every 5±0.5 minutes at 15~35°C. Procedure shall be repeated 1000 times. Then the capacitors shall be left under normal humidity for 1-2 hours before measurement            CR : Nominal Capacitance (μF)</p> <p><b>&lt;Criteria&gt;</b></p> <table border="1"> <tbody> <tr> <td>Leakage current</td> <td>Not more than the specified value.</td> </tr> <tr> <td>Capacitance Change</td> <td>Within ±15% of initial value.</td> </tr> <tr> <td>Dissipation Factor</td> <td>Not more than the specified value.</td> </tr> <tr> <td>Appearance</td> <td>There shall be no leakage of electrolyte.</td> </tr> </tbody> </table> <p><b>Attention:</b>            This test simulates over voltage at abnormal situation only. It is not applicable to such over voltage as often applied.</p>	Leakage current	Not more than the specified value.	Capacitance Change	Within ±15% of initial value.	Dissipation Factor	Not more than the specified value.	Appearance	There shall be no leakage of electrolyte.																																		
Leakage current	Not more than the specified value.																																											
Capacitance Change	Within ±15% of initial value.																																											
Dissipation Factor	Not more than the specified value.																																											
Appearance	There shall be no leakage of electrolyte.																																											

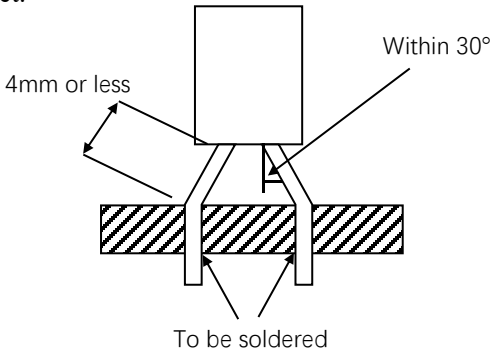

ITEM		PERFORMANCE																
11	Change of temperature test	<p><b>&lt;Condition&gt;</b>            Temperature cycle:            According to IEC60384-4 No.4.7 methods, capacitor shall be placed in an oven, the condition according as below:</p> <table border="1"> <thead> <tr> <th>Temperature</th> <th>Time</th> </tr> </thead> <tbody> <tr> <td>(1) +20°C</td> <td>3 Minutes</td> </tr> <tr> <td>(2) Rated low temperature (- 40°C)(-25°C)</td> <td>30±2 Minutes</td> </tr> <tr> <td>(3) Rated high temperature (+105°C)</td> <td>30±2 Minutes</td> </tr> <tr> <td colspan="2">(1) to (3) =1 cycle, total 5 cycle</td> </tr> </tbody> </table> <p><b>&lt;Criteria&gt;</b>            The characteristic shall meet the following requirement.</p> <table border="1"> <tbody> <tr> <td>Leakage current</td> <td>Not more than the specified value.</td> </tr> <tr> <td>Dissipation Factor</td> <td>Not more than the specified value.</td> </tr> <tr> <td>Appearance</td> <td>There shall be no leakage of electrolyte.</td> </tr> </tbody> </table>	Temperature	Time	(1) +20°C	3 Minutes	(2) Rated low temperature (- 40°C)(-25°C)	30±2 Minutes	(3) Rated high temperature (+105°C)	30±2 Minutes	(1) to (3) =1 cycle, total 5 cycle		Leakage current	Not more than the specified value.	Dissipation Factor	Not more than the specified value.	Appearance	There shall be no leakage of electrolyte.
Temperature	Time																	
(1) +20°C	3 Minutes																	
(2) Rated low temperature (- 40°C)(-25°C)	30±2 Minutes																	
(3) Rated high temperature (+105°C)	30±2 Minutes																	
(1) to (3) =1 cycle, total 5 cycle																		
Leakage current	Not more than the specified value.																	
Dissipation Factor	Not more than the specified value.																	
Appearance	There shall be no leakage of electrolyte.																	
12	Damp heat test	<p><b>&lt;Condition&gt;</b>            Humidity test:            According to IEC60384-4 No.4.12 methods, capacitor shall be exposed for 500±8 hours in an atmosphere of 90~95%R H .at 40±2°C, the characteristic change shall meet the following requirement.</p> <p><b>&lt;Criteria&gt;</b></p> <table border="1"> <tbody> <tr> <td>Leakage current</td> <td>Not more than the specified value.</td> </tr> <tr> <td>Capacitance Change</td> <td>Within ±10% of initial value.</td> </tr> <tr> <td>Dissipation Factor</td> <td>Not more than 120% of the specified value.</td> </tr> <tr> <td>Appearance</td> <td>There shall be no leakage of electrolyte.</td> </tr> </tbody> </table>	Leakage current	Not more than the specified value.	Capacitance Change	Within ±10% of initial value.	Dissipation Factor	Not more than 120% of the specified value.	Appearance	There shall be no leakage of electrolyte.								
Leakage current	Not more than the specified value.																	
Capacitance Change	Within ±10% of initial value.																	
Dissipation Factor	Not more than 120% of the specified value.																	
Appearance	There shall be no leakage of electrolyte.																	
13	Solderability test	<p><b>&lt;Condition&gt;</b>            The capacitor shall be tested under the following conditions:            Soldering temperature : 245 ±5°C            Dipping depth : 2mm            Dipping speed : 25±2.5mm/s            Dipping time : 3±0.5s</p> <p><b>&lt;Criteria&gt;</b></p> <table border="1"> <tbody> <tr> <td>Soldering wetting time</td> <td>Less than 3s</td> </tr> <tr> <td>Coating quality</td> <td>A minimum of 95% of the surface being immersed</td> </tr> </tbody> </table>	Soldering wetting time	Less than 3s	Coating quality	A minimum of 95% of the surface being immersed												
Soldering wetting time	Less than 3s																	
Coating quality	A minimum of 95% of the surface being immersed																	

ITEM	PERFORMANCE								
<p>14</p> <p>Vibration test</p>	<p><b>&lt;Condition&gt;</b>            The following conditions shall be applied for 2 hours in each 3 mutually perpendicular directions. Vibration frequency range : 10Hz ~ 55Hz            each to peak amplitude : 1.5mm            Sweep rate : 10Hz ~ 55Hz ~ 10Hz in about 1 minute            Mounting method: The capacitor with diameter greater than 12.5mm or longer than 25mm must be fixed in place with a bracket.</p>  <p><b>&lt;Criteria&gt;</b>            After the test, the following items shall be tested:</p> <table border="1" data-bbox="400 945 1284 1111"> <tr> <td>Inner construction</td> <td>No intermittent contacts, open or short circuiting. No damage of tab terminals or electrodes.</td> </tr> <tr> <td>Appearance</td> <td>No mechanical damage in terminal. No leakage of electrolyte or swelling of the case. The markings shall be legible.</td> </tr> </table>	Inner construction	No intermittent contacts, open or short circuiting. No damage of tab terminals or electrodes.	Appearance	No mechanical damage in terminal. No leakage of electrolyte or swelling of the case. The markings shall be legible.				
Inner construction	No intermittent contacts, open or short circuiting. No damage of tab terminals or electrodes.								
Appearance	No mechanical damage in terminal. No leakage of electrolyte or swelling of the case. The markings shall be legible.								
<p>15</p> <p>Resistance to solder heat test</p>	<p><b>&lt;Condition&gt;</b>            Terminals of the capacitor shall be immersed into solder bath at <math>260 \pm 5^\circ\text{C}</math> for <math>10 \pm 1</math> seconds or <math>400 \pm 10^\circ\text{C}</math> for <math>3^{-0}</math> seconds to 1.5~2.0 mm from the body of capacitor. Then the capacitor shall be left under the normal temperature and normal humidity for 1~2 hours before measurement.</p> <p><b>&lt;Criteria&gt;</b></p> <table border="1" data-bbox="456 1323 1275 1565"> <tr> <td>Leakage current</td> <td>Not more than the specified value.</td> </tr> <tr> <td>Capacitance Change</td> <td>Within <math>\pm 5\%</math> of initial value.</td> </tr> <tr> <td>Dissipation Factor</td> <td>Not more than the specified value.</td> </tr> <tr> <td>Appearance</td> <td>There shall be no leakage of electrolyte.</td> </tr> </table>	Leakage current	Not more than the specified value.	Capacitance Change	Within $\pm 5\%$ of initial value.	Dissipation Factor	Not more than the specified value.	Appearance	There shall be no leakage of electrolyte.
Leakage current	Not more than the specified value.								
Capacitance Change	Within $\pm 5\%$ of initial value.								
Dissipation Factor	Not more than the specified value.								
Appearance	There shall be no leakage of electrolyte.								
<p>16</p> <p>Vent test</p>	<p><b>&lt;Condition&gt;</b>            The following test only apply to those products with vent products at diameter <math>\geq \phi 6.3</math> with vent.            D.C. test            The capacitor is connected with its polarity reversed to a DC power source. Then a current selected from Table 2 is applied.</p> <p><b>&lt;Table 2&gt;</b></p> <table border="1" data-bbox="456 1794 956 1883"> <tr> <td>Diameter (mm)</td> <td>DC Current (A)</td> </tr> <tr> <td>22.4 or less</td> <td>1</td> </tr> </table> <p><b>&lt;Criteria&gt;</b>            The vent shall operate with no dangerous conditions such as flames or dispersion of pieces of the capacitor and/or case.</p>	Diameter (mm)	DC Current (A)	22.4 or less	1				
Diameter (mm)	DC Current (A)								
22.4 or less	1								

## 8、 Packing Information

Packing Label Marked (the following items shall be marked on the label)

(Inside box or bag)

- (1) Client order number (2) Client part number (3) Beryl part number (4) Capacitance (5) Voltage (6) Dimension  
 (7) Packaging quantity (8) Capacitance tolerance (9) QC Marking (10) Lot number (11) Series

LOT Number :

12 34 56 78910

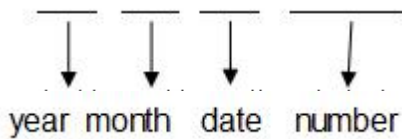

### 1) Bulk Packing:

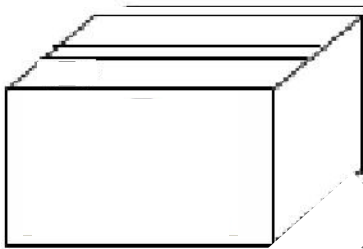

### 2) Taped Packing:

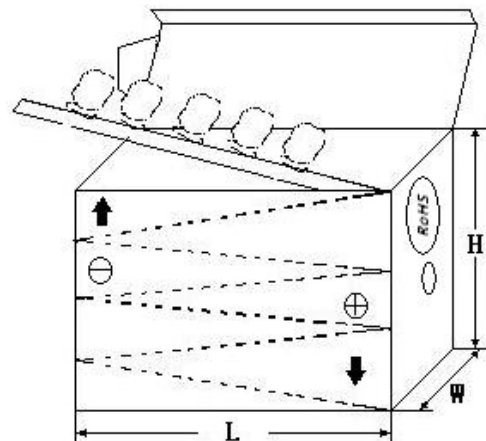

### 3) Outer box



外箱

### 4) Outer box label:

BERYL Zhao Qing Beryl Electronic Technology Co., Ltd.			
C.S.R:		<b>RoHS HF</b>	
C.S.R P/O:			
C.S.R P/N:			
S.P.R P/N:		QC	
SPEC:			
QTY:	PCS	TOL:	%
L/N:		S.P.R:	

## 9、 Prohibition to Use Environment- related Substances

We are hereby to certify the followings:

Our company hereby warrants and guarantees that all or part of products, including, but not limited to, the peripherals, accessories or package, delivered to your company (including your subsidiaries and affiliated companies) directly or indirectly by our company are free from any of the substances listed below.

The latest version of <Substances Prohibited as per RoHS or <Sony-SS-00259>

Accord with heavy metal	Cadmium and cadmium compounds
	Lead and lead compounds
	Mercury and mercury compounds
	Hexavalent chromium compounds
Organic chlorine compounds	Polychlorinated biphenyls (PCB)
	Polychlorinated naphthalenes (PCN)
	Polychlorinated terphenyls (PCT)
	Chlorinated paraffins (CP)
	Other chlorinated organic compounds
Organic bromine compounds	Polybrominated biphenyls (PBB)
	Polybrominated diphenylethers (PBDE)
	Other brominated organic compounds
Tributyltin compounds	
Triphenyltin compounds	
Asbestos	
Specific azo compounds	
Formaldehyde	
Polyvinyl chloride (PVC) and PVC blends	
F、 Cl、 Br、 I	
REACH	

## X-ON Electronics

Largest Supplier of Electrical and Electronic Components

*Click to view similar products for [Aluminium Electrolytic Capacitors - Radial Leaded](#) category:*

*Click to view products by [BERYL](#) manufacturer:*

Other Similar products are found below :

[LXY50VB4.7M-5X11](#) [RFO-100V471MJ7P#](#) [ECE-A1EGE220](#) [B41041A7226M8](#) [B41044A7157M6](#) [EKZM160ETD471MHB5D](#)  
[NCD681K10KVY5PF](#) [NEV1000M25EF-BULK](#) [NEV100M35DC](#) [NEV100M63DE](#) [NEV220M25DD-BULK](#) [NEV.33M100AA](#)  
[NEV4700M50HB](#) [NEV.47M100AA](#) [NEVH1.0M250AB](#) [NEVH3.3M250BB](#) [NEVH3.3M450CC](#) [KM4700/16](#) [KME50VB100M-8X11.5](#)  
[SG220M1CSA-0407](#) [ES5107M016AE1DA](#) [ESMG160ETD102MJ16S](#) [ESX472M16B](#) [227RZS050M](#) [476CKH100MSA](#) [477RZS050M](#)  
[UVX1V101KPA1FA](#) [UVX1V222MHA1CA](#) [KME25VB100M-6.3X11](#) [VTL100S10](#) [VTL470S10](#) [VTL470S16A](#) [511D336M250EK5D](#)  
[052687X](#) [ECE-A1CF471](#) [NRE-S560M16V6.3X7TBSTF](#) [RGA221M1CTA-0611G](#) [ERZA630VHN182UP54N](#) [UPL1A331MPH](#)  
[SK035M0100AZS-0611](#) [MAL214658821E3](#) [NEV1000M6.3DE](#) [NEV100M16CB](#) [NEV100M50DD-BULK](#) [NEV2200M16FF](#) [NEV220M50EE](#)  
[NEV2.2M50AA](#) [NEV330M63EF](#) [NEV4700M35HI](#) [NEV4.7M100BA](#)