

BESSEY Clamping- and Cutting Technology

Complete catalogue 2021/2022

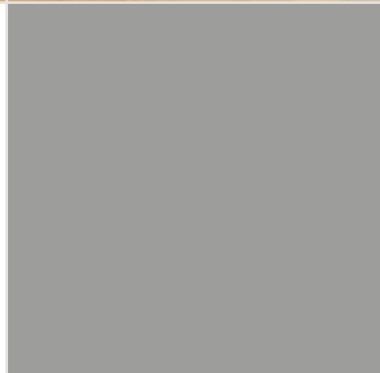
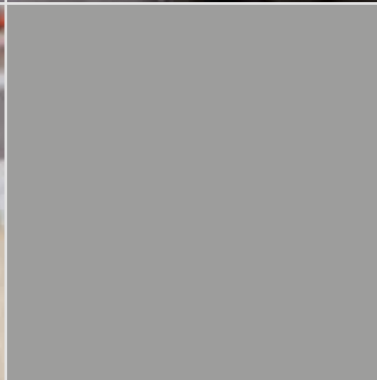

Features of BESSEY products

You can identify the individual performance features of BESSEY products with the help of assigned symbols. The complete overview here:

Allgemein

| | | |
|--|---|---|
|  |  |  |
| Order -No. | Weight | Packaging unit |















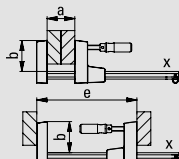

V1 – V3 = Clamping Technology discount groups
V4 – V6 = Cutting Technology discount groups

We request you to place your orders in packaging units.

















The BESSEY Product Development Department reserves the right for technical alterations. Errors and omissions excepted – to the best of our knowledge the information supplied is accurate.

Note that you are not entitled to any claims from the contract or delict, in particular product liability claims due to personal injuries or material damage, from our company if you do not observe our **warning and usage notices**.

Clamping technology

| | | | | |
|--|---|---|---|---|
|  |  |  |  | |
| Wood | Steel | Plastic | Sensitive materials | |
|  |  |  |  |  |
| Opening | Throat depth | Rail | Spreading width | |
|  |  |  |  | |
| Diameter | Angle | Hole dia | Clamping force | |
|  |  |  |  | |
| Jaw width | Jaw height | Strength of current max. | Fixing screw hole dia | |

Cutting Technology

| | | | |
|--|---|---|--|
|  | Overall length |  | Continuous, straight and curved cuts, right |
|  | Blade length |  | Continuous, straight and curved cuts, left |
|  | Sheet thickness (600 N/mm ²) |  | Short, straight and narrow curved cuts, right |
|  | Product life expectancy |  | Short, straight and narrow curved cuts, left |
|  | HSS-TIN min. 65 HRC |  | Straight and curved cuts with a large radius in both left and right directions |
|  | HSS min. 65 HRC |  | Continuous, straight cuts |
|  | Special High grade steel min. 61 HRC |  | Short, straight cuts, notch |
|  | High grade steel min. 59 HRC |  | Circular cuts |
|  | Quality steel min. 56 HRC | | |

L = Left cut design (refer to page 136 as well)
SB = On carded hang pack

Standard tin snips with a rocker spring, available on request for an extra charge.

Warning and usage notices:

General:

- Only use the hand tool properly. Observe the enclosed operating instructions.
- Never change or modify tools. They are only permitted to be used in their original state. Only use original spare parts if required. Exceptions: Sharpen cutting tools properly.
- Never work with damaged tools. Damaged tools must be replaced immediately.
- Handles must be free of oil and grease.
- Tasks while clamped may only be carried out by trained staff using VDE tools that are suitable for this purpose.
- Wear safety goggles for all tasks in which chips may be formed or in which parts can flake off.
- Protect your hands by wearing working or assembly gloves depending on the task.
- Select a stable base to ensure safe standing. Wear safety shoes.
- Observe the maintenance instructions. Proper use can only be guaranteed if the tools are maintained regularly. The maintenance instructions are provided at www.bessey.de.
- Furthermore, the relevant safety precautions from the various institutions such as the regulations from the accident prevention and insurance associations, instructions from your employer and the legal regulations of the appropriate country also apply.

Clamping tools:

- Clamping tools are not suitable for lifting, pulling or transporting.
- Clamping tools may only be clamped manually without using any auxiliary tools.
- Improper use can cause personal injuries or material damage.
- Never change or modify clamping tools. Only use them in their original condition. Only use original spare parts if required.

Cutting tools:

- Manual sheet metal snips may only be used to cut thin sheets of soft metals or steel. They are not suitable for cutting through round or rectangular section metal shapes such as wires.
- Cutting tools may only be used manually without using any auxiliary tools.
- Always wear safety goggles and gloves when working. Cut parts can injure workers and bystanders.
- Improper use can cause personal injuries or material damage.
- Disconnect the connection to the power supply when carrying out work on electrical equipment. Otherwise, you may get an electric shock.
- Always cut away from the head when using snips and knives.
- Always store cutting tools with the cutting edges closed and in a location where they are clearly visible. The handle must be pointing towards you.
- Store cutting tools separately. This saves the cutting edges and your fingers.
- Sharpen cutting tools regularly. Blunt tools increase the risk of injury and require more force for the same cutting performance.

Pliers:

- Wear safety goggles and gloves while working. Cut parts can injure workers and bystanders.
- Disconnect the connection to the power supply when carrying out work on electrical equipment. Otherwise, you may get an electric shock.
- Never use pliers as a hammer.
- Check the jaws for wear. Worn jaws cause slipping and result in accidents.
- Grip pliers are only suitable for fixing workpieces for a short time.

General product information:

1. BESSEY reserves the right to change the technical specifications at any time. It is possible that certain product specifications may differ from region to region, to satisfy the international market.
2. All illustrations produced by BESSEY and that show BESSEY tools in use are only intended to provide the person viewing them with an impression of the tool's relevant area of application. When taking the photographs, safety clothing such as gloves was sometimes not worn, in order to demonstrate the products better. However, this does not relieve the customer of their obligation to wear suitable safety clothing when working with BESSEY clamping and cutting tools.
3. The customer takes sole responsibility for confidentiality and use of information on a product and for using or operating a product. BESSEY explicitly rejects any liability for direct, indirect, accidental or subsequent damage. Furthermore, all claims for damages, compensation for loss and other claims are limited to the purchase price of the relevant product.



12-21 Malleable cast iron screw clamps

Malleable cast iron screw clamp **TG**
 – with 2-component plastic handle
 – with tried-and-true wooden handle
 – with tommy bar

Heavy duty malleable cast iron screw clamp **TGK**
 – with 2-component plastic handle
 – with tried-and-true wooden handle
 – with tommy bar

Pressure cap strips **SKS**

Malleable cast iron screw clamp **TPN**
 – with 2-component plastic handle
 – with tried-and-true wooden handle

Heavy duty malleable cast iron screw clamp **TKPN**
 – with tried-and-true wooden handle

Malleable cast iron screw clamp **TGRC**
 – with tried-and-true wooden handle
 – with tommy bar

Heavy duty malleable cast iron screw clamp **TGKR**
 – with tried-and-true wooden handle

Deep throat screw clamp **TGNT**
 – with tried-and-true wooden handle
 – with tommy bar

22-29 All-steel screw clamps

All-steel screw clamp **GZ**
 – with 2-component plastic handle
 – with tried-and-true wooden handle
 – with tommy bar
 – with swivel handle

NEW

All-steel screw clamp **classiX GS**
 – with tried-and-true wooden handle
 – with tommy bar

OMEGA screw clamp **GMZ**
 – with 2-component plastic handle
 – with tommy bar

Pressure cap strips **SKS**

30-33 Lever clamps

Lever clamp **GH**

Lever clamp **SGHS**, heavy duty

Lever clamp **classiX GSH**

34-39 High-performance clamps

Fitters' clamp **SLM**

High-performance clamp **SGM**

High-performance clamp **SGTM**, large throat depth

High-performance clamp **STBM**

High-performance clamp **STBS**

High-performance clamp **STBVC**

Special pressure plate with sintered steel insert

Fitters' clamp **classiX GSL**
 High-performance clamp **classiX GSM**

40-41 KombiKlapp

KombiKlapp **SG-VAD**

42-45 U-shaped clamps

U-shaped clamps **GUZ**, **SGU**, **STBU**

U-shaped lever clamp **GUH**

Special pressure plate with sintered steel insert

46-47 Claw clamps

Claw clamp **GRA**
 Pressure piece **GRD**

48-51 Variable screw clamps

High-performance clamp set **SLV / GSV**

Special pressure plate with sintered steel insert

Rails for size **SLV / GSV**

Sliding arm for size **SLV / GSV**

52-53 C-clamps

C-clamp **VC**, **SC**, **CDF-C**

Table of contents

54-55 Grip pliers

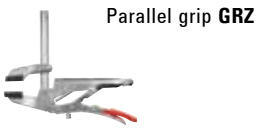

Parallel grip **GRZ**



C-grip **GRZC**



Variogrip **GRZV**



Pipe grip **GRZRO**

56 Earth (ground) clamps

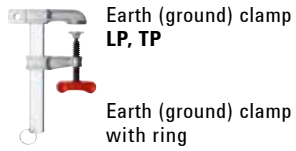

Earth (ground) clamp **LP, TP**

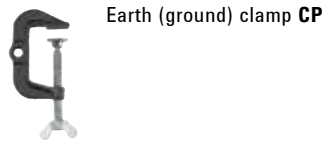

Earth (ground) clamp **TP** with ring

57 Clamping devices

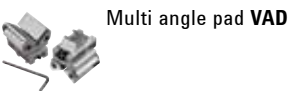

Multi angle pad **VAD**



Edge clamp **KT**

58-59 Metal angle clamps

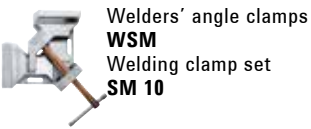

Welders' angle clamps **WSM**
Welding clamp set **SM 10**

60-67 Clamping elements for welding tables

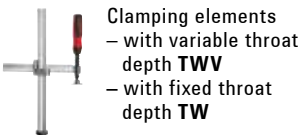

Clamping elements
– with variable throat depth **TWV**
– with fixed throat depth **TW**



Clamping element for welding tables with special pressure plate **TW28**

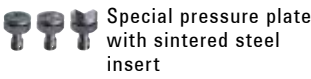

Special pressure plate with sintered steel insert



Clamping element for welding tables with gripping arm **TW28GRS**

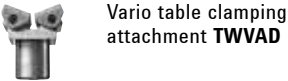

Vario table clamping attachment **TWVAD**



Accessories:
Toggle clamp adapter **TWA-STC**
Extension **TWX**
Tilting adapter **TW28AV**
Attachment **TW28HO**

68-73 Machine table clamps



Machine table clamp **BAS-C, BAS-CB**

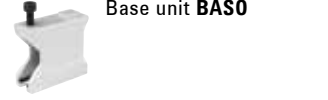

Base unit **BASO**



Hold down table clamp **BS**

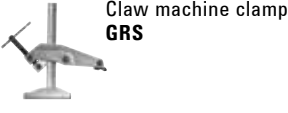

Claw machine clamp **GRS**



Hold down table clamp **BSG**

74-79 Toggle clamps



Vertical toggle clamp **STC-VH**
– with horizontal base plate

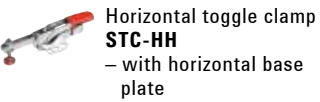

Horizontal toggle clamp **STC-HH**
– with horizontal base plate



Push/pull clamp **STC-IHH**
– with horizontal base plate



Accessory set for multifunction table **STC-SET-T20**

80-85 Parallel clamps and area pressure clamps



K Body REVO **KRE**
K Body REVO Vario **KREV**

Accessories:
Variable jaw **KRE-VO**
Adapter **KR-AS**
Framing set **KP**
Extender **KBX**
Table clamp **TK6**



Lightweight K Body **UniKlamp UK**

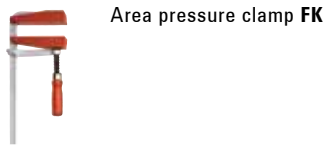

Area pressure clamp **FK**

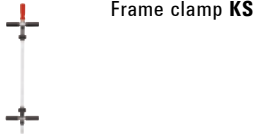

Frame clamp **KS**

86-87 Gearclamp



GearKlamm **GK**

88-93 One-handed clamps

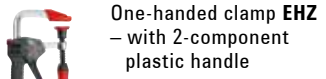

One-handed clamp **EHZ**
– with 2-component plastic handle



NEW
One-handed clamp **EZ**



One-handed clamp
DuoKlamp **DUO**



One-handed clamp
EZS

94-95

Rafter clamps



Rafter clamp **SPZ**

Special pressure plate
with sintered steel
insert

96-102

Lightweight clamps



High-tech lever clamp
KliKlamp **KLI**



Light duty bar clamp
U-style **LMU**
Die-cast zinc screw
clamp **LM**



Wood-Klemmy **HKL**



Aluminium mini clamp
AM



Parallel screw clamp **PA**



Mini Vice **S 10**
Table clamp **TK**

103-105

Table clamps

NEW



One-handed table clamp
EZR



All-steel table clamp
GTR

All-steel table clamp
GTRH with lever handle

106-107

Spring clamps



VarioClippix **XV**
Clippix **XC**
Clippix **XCL**,
Needle nose spring clamp

NEW

Spring clamp **XM**

108-109

Band clamps



Band clamp
BAN 700, **BAN 400**
Vario corners **BVE**

110-111

Angle and mitre clamps



Angle clamp
WS 3, **WS 6**, **WS 1**



Mitre clamping system
MCX

112-114

Edge clamps



One-handed edge clamp
EKT



Edge clamp Kantenfix
KF



Edge clamp **KT**



C-frame edge clamp
KT



Panel carrier **KFP**

115-117

Clamping elements for workbenches



Workbench adapter
TW16AW



Clamping element with
variable throat depth
TWV16



Clamping element with
fixed throat depth **TW16**

118-119

Clamping elements for multifunction tables

NEW



Clamping element for
multifunction tables
TW-KLI



Toggle clamp systainer
STC-S-MFT



Adapter for multi-
function tables
STC-SET-T20



STC accessory set for
multifunction tables
STC-xxx-T20

120-121

Seaming tools



Seaming tool **PS 130**,
big and strong



Seaming tool **PS 55**

122-124

Door frame and window assembly tools



Door frame clamp
TU, **TMS**



Door frame clamp
extender **TUX**



Door frame
straightening clamp
TFM / Angle door frame
straightening clamp
WTR

Table of contents



Window installation clamp **FRK**

124 Pipe clamping set



Pipe clamping set **BPC**

125 Sash clamps



Sash clamp **TAN, TB**



Sash clamp, light **TL**

126-127 Special flooring tools



Spacer **AV2**



Spacer **PVA**

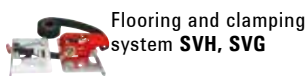

Flooring and clamping system **SVH, SVG**

128-131 Telescopic drywall supports



Telescopic drywall support **ST**

NEW

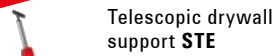

Telescopic drywall support **STE**

NEW

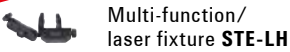

Accessories: Multi-function/laser fixture **STE-LH**



Support plate **STE-SP35**



Replacement contact surface **3101952**

132-133 POS Presentation



Sales display **ST18-D**



Demonstration trolley **VFW**



Clamp trolley **ZW**

Cutting technology

138-147 Compound leverage snips



Shape and straight cutting snips the latest generation **D39ASS**



Shape and straight cutting snips **D29ASS-2/D27A/D17A/D08**



Shape cutting snips **D29SS-2/D27**



Straight cutting snips **D29BSS-2/D27B**



MULTISNIP Longstyle **D22A**



Shape cutting snips **D16/D16L/D16S**

Display **D16S-D**

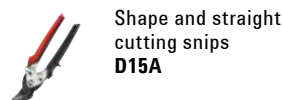

Shape and straight cutting snips **D15A**

148-151 High-performance snips with HSS edges



Shape and straight cutting snips HSS-TiN **D27AH-TiN**

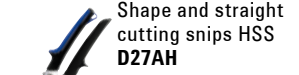

Shape and straight cutting snips HSS **D27AH**



Punch snips HSS **D407**



Shape and straight cutting snips HSS **D416**



Pelican snips HSS **D418**

152-158 Standard tin snips



Shape and straight cutting snips **D216/D116**

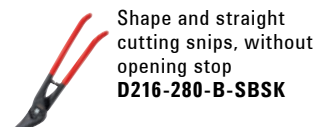

Shape and straight cutting snips, without opening stop **D216-280-B-SBSK**



Pelican snips **D218/D118**



Shape cutting punch snips **D214/D114**



Punch snips **D207/D107**

Table of contents

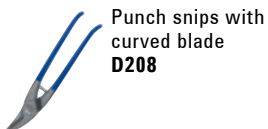

Punch snips with curved blade
D208



Universal-snips
D106



Universal snips with wide blades
D106A



Berlin pattern snips
D202/D102



English pattern snips
D159



American pattern snips
D146



Display **DVK, DVK2**
unstocked

159-161 Multi-purpose cutters



Multi-purpose cutters
D47-2/D48-2/D48A-2



Cable cutter
D49-2



MULTISNIP Master
D51A



Multi-purpose cutters
D47/D48/D48A



Cable cutter
D49



Combinox
D50

162-163 Folding utility knives and multitool



Folding utility knives
DBKPH/DBKWH/DBKAH
Spare blades
DBK-T/DBK-H/DBK-L



Knife-set
DBKPH



Multitool
DBST

164-165 Jewellers' and thin sheet snips



Jewellers' snips
D70/D71/D72
D74/D75/D76

166-167 Household and multi-purpose shears



Multi-purpose shears
D820/D821



Electricians' scissors
D53



Household and dressmakers' shears
D840



Paperhangers' and paper shears
D853



Industrial and professional shears
D860

168-169 Steel strap cutters



Safety strap cutter with compound leverage
D123S



Steel strap cutters
D122N/D122A

170-173 Tools for sheet metal work and plumbing



Seaming and clinching pliers
D33/D331/D34/D341/D35/D351



Seaming and clinching pliers
D33...P/D331...P/D34...P/D341...P/D35...P/D351...P



Mini folding pliers
D331-22/D341-22



Flat-nosed pliers for sheet metal work
D301



Round nosed pliers
D311



Folding pliers
D355



Corner seaming and clinching pliers
D335



Squeeze folding pliers
D336



Crimper
D36



Gutter support bowing pliers
D396

BESSEY – an unprecedented story

Innovation with tradition

In 1889, Max BESSEY founded the company **BESSEY & Sohn** in Stuttgart as a bright steel drawing plant. Since then, the company has continuously expanded the range of products it offers. It was this spirit that led BESSEY to begin production of manual clamping tools in the mid-1930s. Since then, the strength of its innovation has been underlined by the granting of numerous patents. In 1979, with the takeover of Diener Werkzeugfabrik GmbH, a company rich in tradition, BESSEY established its cutting technology unit with the already popular Erdi snips.

In 2004 BESSEY & Sohn was spun into **BESSEY Tool**, handling the clamping and cutting technology areas, and **BESSEY Präzisionsstahl**, a leading German producer-independent and industry-independent supplier of high-quality bright and stainless steels. This unique positioning of BESSEY as a producer of tools and precision steels ensures significant advantages in terms of quality. It allows BESSEY Tool to procure its rails and spindles directly from the BESSEY Präzisionsstahl, giving it precise knowledge of the steel quality that is going into particular components which are subjected to particular high stresses. This is because bright steels are produced and tested at BESSEY Precision Steel with consistently high quality and the utmost precision, in cutting-edge facilities.

“To stop improving is to stop being good.” The motto of company founder Max Bessey remains true today, as it will in the future, and is the guiding principle to everything that the company does.

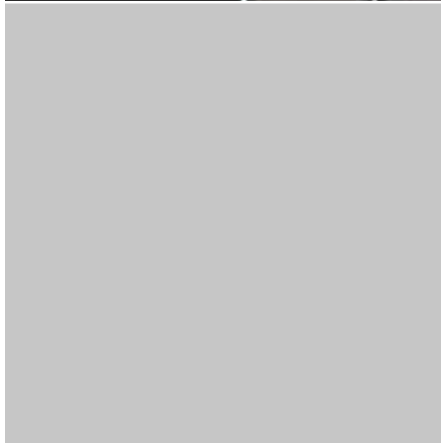



- 1889** Max Bessey founds a bright steel drawing plant in Stuttgart.
- 1912** Continuation of the firm by his nephew Karl Bessey.
- 1926** The company is taken over by Dr. Ing. Eugen Mayer. Under his leadership, the range of products produced is significantly expanded, both in terms of dimensions and grades of steel offered.
- 1928** 1928 marriage of Dr. [Eng.] Eugen Mayer and Erna Bessey, widow of Karl Bessey
- 1936** Patents granted for a new type of malleable cast iron screw clamp, thus marking the beginning of the production of clamping tools by Bessey.
- 1944** Founding of a subsidiary in Bietigheim for producing clamping tools.
- 1952** Patent granted for a tempered all-steel clamp.
- 1961** Expansion of the Bietigheim works and beginning of bright steel production.
- 1966** Dr. Mayer succeeded by his daughter, Dr. Erna Fetscher and son, Dr. Theodor Mayer, who becomes Managing Partner.
- Start of a dynamic phase of corporate development:
- Production of bright steel is doubled and complemented by the manufacture of stainless steels.
 - New patents and developments, combined with modern marketing, make BESSEY into the market leader in the global clamping tools sector.
- 1971** A further increase in bright steel production is achieved at the Stuttgart works thanks to the purchase of the neighbouring Aldinger engineering works.
- Founding of BESSEY FILS in Strasbourg, from which the company BESSEY-SER arose in 1988.
- 1979** Purchase of the Diener shears factory in Esslingen, with a satellite factory in Solingen.
- 1983** Consolidation of bright steel production in new mill buildings at the Bietigheim works and sale of the Stuttgart site.
- 1985** Purchase of additional land in Bietigheim, including the area of the former worsted spinning mill, which has protected status. After proper restoration, tool production begins at this facility.
- 2003** Takeover of our sales partner in the strategically important North American market.
- 2004** Takeover of the GROSS STABIL clamping tool brand as part of our global growth strategy.
- 2007** Integration of GROSS STABIL TOOL to enhance effects of synergy with additional leverage.
- 2011** Klaus Fuchs becomes Managing Partner – after 11 years, the BESSEY Group is once again owner-managed.
- 2019** The company celebrates 130 years.
- 2020** Carsten Spang becomes managing director of BESSEY Tool GmbH & Co KG and BESSEY Präzisionsstahl GmbH.

BESSEY. Simply better.

BESSEY locations

The headquarters of the BESSEY Group are located near Stuttgart, in south west Germany. Since 1983, all administrative functions as well as Sales, Production, our laboratory, and the logistics operation for BESSEY Precision Steel have been consolidated on a 50,000 square metre site in Bietigheim-Bissingen.

The development, manufacture, storage and dispatch of clamping and cutting tools takes place some 2 km north of the main works, in the building of the historic, former Kammgarnspinnerei Bietigheim-Bissingen (worsted spinning mill).

BESSEY Tools North America, based in Cambridge Ontario, close to Toronto in Canada, is part of the BESSEY Group, and handles the whole North American market in its capacity as a sales and marketing business.





With BESSEY ...

... you are placing your trust in quality

Precision and long life are at the core of the BESSEY brand's quality. The tools have traditionally been manufactured from the highest-grade materials. Thus, the steel for the manufacturing of rails and spindles, for example, comes directly from BESSEY Präzisionsstahl. In addition, all components are tested by experienced technicians and development engineers using ultramodern process control techniques.

... you are placing your trust in innovation

"To stop improving is to stop being good." The motto of company founder Max Bessey remains true today and is the guiding principle to everything that the company does. New products and improvements thus continue to be developed on a long-term basis from innovative ideas, making the operator's work easier. The focus is on convenience and safety. User-friendly operation and ergonomics represent the highest benchmark.

... you are placing your trust in variety

Thanks to the designers' many years of experience and to continuous communication with customers, BESSEY has a strong awareness of problem-solving. The result is clamping and cutting tools true to our guiding principle: "BESSEY. Simply better." With over 1,600 products, BESSEY now offers a tremendously wide and deep range of items customised to special requirements.

... you are placing your trust in service

Reliability, confidence and sense of responsibility are the backbone of our partnership with the environment and customers. BESSEY has distinguished itself as an extremely service-oriented and futuristic company. We are also supporting our trading partners, for instance, with comprehensive product training programs. This is clearly a complete partnership.



Malleable cast iron screw clamps

Powerful, rigid clamping



The unmistakable classic

Often copied, never equalled: the original malleable cast iron screw clamps from BESSEY – the classic screw clamps dating back to 1936. Unmistakable, thanks to their unique high-quality profiled rail and their characteristic malleable cast iron arms,

serrated for reinforcement. The integrated BESSEY anti-slip system additionally ensures maximum safety. This is why the original BESSEY malleable cast iron screw clamps have proved so successful for so many years. And so ideal for all applications where powerful, rigid clamping is required. Try them out for yourself!

The screw clamp TGK – extremely stable, especially for high clamping pressures and wide openings.

The deep throat clamp TGNT – for large-scale jobs and throat depths of up to 500 mm.

Malleable cast iron screw clamps



Original BESSEY malleable cast iron screw clamp

Only the original can be the best



You Tube



The unmistakable classic

Often copied, never equalled: the original malleable cast iron screw clamps from BESSEY – are unmistakable, thanks to their unique high-quality profiled rail and their characteristic malleable cast iron arms, serrated for reinforcement. The integrated anti-slip system additionally ensures maximum safety. This is why the original BESSEY malleable cast iron screw clamps have proved so successful for so many years. And so ideal for all applications where powerful, rigid clamping is required.

Your benefits at a glance:

- 1 Integrated BESSEY anti-slip system**
Maximum safety is available with the integrated BESSEY anti-slip system, when clamping with a throat depth of 80 mm or more. A set screw that is molded into the sliding arm interlocks with the serration on the rail. This effectively prevents the clamp from dislodging or slipping away.
- 2 Reinforced malleable iron clamps**
Both the upper and lower sections are produced from high-quality malleable iron and reinforced by shafts. The powder coating protects against corrosion and the characteristic shaft profile works as a reliable reinforcement against torsion forces.

3 High-quality profiled rail

The BESSEY profiled rail from our own drawing plant has been especially optimised for clamps. The serration on six faces additionally prevents the clamp from slipping.

4 Pressure plate

For enhanced serviceability the pressure plate can be changed with no need for tools. It can be replaced very easily and quickly.

Malleable cast iron screw clamps



Original BESSEY malleable cast iron screw clamp TG with 2-component plastic handle



| № | <a> | | <x> | ⚖ | 📦 | V1 |
|-------------|------|-----|---------|------|------|----|
| | mm | mm | mm | kg | qty. | |
| TG10-2K | 100 | 50 | 15 x 5 | 0.26 | 10 | |
| TG12-2K | 120 | 60 | 20 x 5 | 0.42 | 10 | |
| TG16-2K | 160 | 80 | 25 x 6 | 0.66 | 10 | |
| TG20B8-2K | 200 | 80 | 25 x 6 | 0.77 | 10 | |
| TG25B8-2K | 250 | 80 | 25 x 6 | 0.82 | 10 | |
| TG30B8-2K | 300 | 80 | 25 x 6 | 0.87 | 10 | |
| TG40B8-2K | 400 | 80 | 25 x 6 | 0.97 | 10 | |
| TG20-2K | 200 | 100 | 27 x 7 | 1.06 | 10 | |
| TG25S10-2K | 250 | 100 | 27 x 7 | 1.15 | 10 | |
| TG30S10-2K | 300 | 100 | 27 x 7 | 1.18 | 10 | |
| TG40S10-2K | 400 | 100 | 27 x 7 | 1.33 | 10 | |
| TG50S10-2K | 500 | 100 | 27 x 7 | 1.46 | 10 | |
| TG25-2K | 250 | 120 | 29 x 9 | 1.54 | 10 | |
| TG30S12-2K | 300 | 120 | 29 x 9 | 1.63 | 10 | |
| TG40S12-2K | 400 | 120 | 29 x 9 | 1.78 | 10 | |
| TG50S12-2K | 500 | 120 | 29 x 9 | 1.98 | 10 | |
| TG60S12-2K | 600 | 120 | 29 x 9 | 2.13 | 5 | |
| TG80S12-2K | 800 | 120 | 29 x 9 | 2.46 | 5 | |
| TG100S12-2K | 1000 | 120 | 29 x 9 | 2.83 | 5 | |
| TG30-2K | 300 | 140 | 32 x 10 | 2.20 | 10 | |
| TG40S14-2K | 400 | 140 | 32 x 10 | 2.41 | 5 | |
| TG50S14-2K | 500 | 140 | 32 x 10 | 2.62 | 5 | |
| TG60S14-2K | 600 | 140 | 32 x 10 | 2.85 | 5 | |
| TG80S14-2K | 800 | 140 | 32 x 10 | 3.29 | 5 | |
| TG100S14-2K | 1000 | 140 | 32 x 10 | 3.71 | 5 | |
| TG40-2K | 400 | 175 | 32 x 10 | 2.70 | 5 | |
| TG50S17-2K | 500 | 175 | 32 x 10 | 2.90 | 1 | |
| TG60S17-2K | 600 | 175 | 32 x 10 | 3.16 | 1 | |
| TG80S17-2K | 800 | 175 | 32 x 10 | 3.50 | 1 | |
| TG100S17-2K | 1000 | 175 | 32 x 10 | 4.00 | 1 | |



Heavy duty malleable cast iron screw clamp TGK with 2-component plastic handle



| № | <a> | | <x> | ⚖ | 📦 | V1 |
|-----------|------|-----|---------|------|------|----|
| | mm | mm | mm | kg | qty. | |
| TGK40-2K | 400 | 120 | 35 x 11 | 2.52 | 5 | |
| TGK50-2K | 500 | 120 | 35 x 11 | 2.70 | 5 | |
| TGK60-2K | 600 | 120 | 35 x 11 | 3.00 | 5 | |
| TGK80-2K | 800 | 120 | 35 x 11 | 3.53 | 5 | |
| TGK100-2K | 1000 | 120 | 35 x 11 | 4.00 | 5 | |
| TGK125-2K | 1250 | 120 | 35 x 11 | 4.48 | 1 | |
| TGK150-2K | 1500 | 120 | 35 x 11 | 5.31 | 1 | |
| TGK200-2K | 2000 | 120 | 35 x 11 | 6.66 | 1 | |
| TGK250-2K | 2500 | 120 | 35 x 11 | 7.93 | 1 | |
| TGK300-2K | 3000 | 120 | 35 x 11 | 9.20 | 1 | |



- Clamping force up to 6,000 N
- High-quality 2-component plastic handle
- Pressure plates can be replaced by hand – no tools required (from 80 mm throat depth)
- With protective caps on the clamping surfaces
- Stable profiled rail with serration
- BESSEY anti-slip system (from 80 mm throat depth)



- Clamping force up to 7,000 N
- Strengthened design for higher clamping force and wider opening widths
- High-quality 2-component plastic handle
- Pressure plates can be replaced by hand – no tools required
- Stable profiled rail with serration
- BESSEY anti-slip system

Malleable cast iron screw clamps



- Clamping force up to 6,000 N
- Ergonomically shaped wood handle
- Pressure plates can be replaced by hand – no tools required (from 80 mm throat depth)
- With protective caps on the clamping surfaces
- Stable profiled rail with serration
- BESSEY anti-slip system (from 80 mm throat depth)



Original BESSEY malleable cast iron screw clamp TG with tried-and-true wooden handle

| № | ←a→ | ←b→ | ←x→ | ⚖ | 📦 | V1 |
|----------|------|-----|---------|------|------|----|
| | mm | mm | mm | kg | qty. | |
| TG10 | 100 | 50 | 15 x 5 | 0.26 | 10 | |
| TG15B5 | 150 | 50 | 15 x 5 | 0.29 | 10 | |
| TG20B5 | 200 | 50 | 15 x 5 | 0.31 | 10 | |
| TG12 | 120 | 60 | 20 x 5 | 0.42 | 10 | |
| TG20B6 | 200 | 60 | 20 x 5 | 0.47 | 10 | |
| TG30B6 | 300 | 60 | 20 x 5 | 0.54 | 10 | |
| TG16 | 160 | 80 | 25 x 6 | 0.66 | 10 | |
| TG20B8 | 200 | 80 | 25 x 6 | 0.77 | 10 | |
| TG25B8 | 250 | 80 | 25 x 6 | 0.82 | 10 | |
| TG30B8 | 300 | 80 | 25 x 6 | 0.87 | 10 | |
| TG40B8 | 400 | 80 | 25 x 6 | 0.97 | 10 | |
| TG20 | 200 | 100 | 27 x 7 | 1.07 | 10 | |
| TG25S10 | 250 | 100 | 27 x 7 | 1.12 | 10 | |
| TG30S10 | 300 | 100 | 27 x 7 | 1.18 | 10 | |
| TG40S10 | 400 | 100 | 27 x 7 | 1.33 | 10 | |
| TG50S10 | 500 | 100 | 27 x 7 | 1.44 | 10 | |
| TG25 | 250 | 120 | 29 x 9 | 1.54 | 10 | |
| TG30S12 | 300 | 120 | 29 x 9 | 1.59 | 10 | |
| TG40S12 | 400 | 120 | 29 x 9 | 1.78 | 10 | |
| TG50S12 | 500 | 120 | 29 x 9 | 1.95 | 10 | |
| TG60S12 | 600 | 120 | 29 x 9 | 2.11 | 5 | |
| TG80S12 | 800 | 120 | 29 x 9 | 2.46 | 5 | |
| TG100S12 | 1000 | 120 | 29 x 9 | 2.80 | 5 | |
| TG30 | 300 | 140 | 32 x 10 | 2.20 | 10 | |
| TG40S14 | 400 | 140 | 32 x 10 | 2.41 | 5 | |
| TG50S14 | 500 | 140 | 32 x 10 | 2.62 | 5 | |
| TG60S14 | 600 | 140 | 32 x 10 | 2.85 | 5 | |
| TG80S14 | 800 | 140 | 32 x 10 | 3.27 | 5 | |
| TG100S14 | 1000 | 140 | 32 x 10 | 3.68 | 5 | |
| TG40 | 400 | 175 | 32 x 10 | 2.67 | 5 | |
| TG50S17 | 500 | 175 | 32 x 10 | 2.88 | 1 | |
| TG60S17 | 600 | 175 | 32 x 10 | 3.10 | 1 | |
| TG80S17 | 800 | 175 | 32 x 10 | 3.50 | 1 | |
| TG100S17 | 1000 | 175 | 32 x 10 | 3.95 | 1 | |

- For screw clamps
- For gentle clamping
- May be applied on both sides
- Cut them to size



Pressure cap strips SKS (2 pcs./bag)

| № | Suitable for | V3 |
|----------|---|----|
| | SKS10/20 | |
| SKS20/40 | TG20 to TG40 / TGK / GZ20 to GZ60 / GM20Z to GM60Z | |

Malleable cast iron screw clamps



Heavy duty malleable cast iron screw clamp TKG with tried-and-true wooden handle



| № | <a> | | <x> | ⚖ | 📦 | V1 |
|--------|------|-----|---------|------|------|----|
| | mm | mm | mm | kg | qty. | |
| TGK40 | 400 | 120 | 35 x 11 | 2.48 | 5 | |
| TGK50 | 500 | 120 | 35 x 11 | 2.70 | 5 | |
| TGK60 | 600 | 120 | 35 x 11 | 3.00 | 5 | |
| TGK80 | 800 | 120 | 35 x 11 | 3.49 | 5 | |
| TGK100 | 1000 | 120 | 35 x 11 | 4.00 | 5 | |
| TGK125 | 1250 | 120 | 35 x 11 | 4.54 | 1 | |
| TGK150 | 1500 | 120 | 35 x 11 | 5.23 | 1 | |
| TGK200 | 2000 | 120 | 35 x 11 | 6.65 | 1 | |
| TGK250 | 2500 | 120 | 35 x 11 | 7.80 | 1 | |
| TGK300 | 3000 | 120 | 35 x 11 | 9.17 | 1 | |

- Clamping force up to 7,000 N
- Heavy duty, reinforced design for higher clamping force and wider opening widths
- Ergonomically shaped wood handle
- Pressure plates can be replaced by hand – no tools required
- Stable profiled rail with serration
- BESSEY anti-slip system



Original BESSEY malleable cast iron screw clamp TG with tommy bar



| № | <a> | | <x> | ⚖ | 📦 | V1 |
|----------|-----|-----|---------|------|------|----|
| | mm | mm | mm | kg | qty. | |
| TG16K | 160 | 80 | 25 x 6 | 0.72 | 10 | |
| TG20K | 200 | 100 | 27 x 7 | 1.05 | 10 | |
| TG25K | 250 | 120 | 29 x 9 | 1.48 | 10 | |
| TG30S12K | 300 | 120 | 29 x 9 | 1.56 | 10 | |
| TG40S12K | 400 | 120 | 29 x 9 | 1.74 | 10 | |
| TG30K | 300 | 140 | 32 x 10 | 2.10 | 10 | |
| TG40K | 400 | 175 | 32 x 10 | 2.62 | 5 | |

- Clamping force up to 6,000 N
- Tommy bar with rounded ends for simple transfer of force when clamping
- Pressure plates can be replaced by hand – no tools required
- With protective caps on the clamping surfaces
- Stable profiled rail with serration
- BESSEY anti-slip system



Heavy duty malleable cast iron screw clamp TKG with tommy bar



| № | <a> | | <x> | ⚖ | 📦 | V1 |
|---------|------|-----|---------|------|------|----|
| | mm | mm | mm | kg | qty. | |
| TGK50K | 500 | 120 | 35 x 11 | 2.66 | 5 | |
| TGK100K | 1000 | 120 | 35 x 11 | 3.94 | 5 | |
| TGK150K | 1500 | 120 | 35 x 11 | 5.23 | 1 | |
| TGK200K | 2000 | 120 | 35 x 11 | 6.50 | 1 | |
| TGK250K | 2500 | 120 | 35 x 11 | 7.81 | 1 | |
| TGK300K | 3000 | 120 | 35 x 11 | 9.10 | 1 | |

- Clamping force up to 7,000 N
- Strengthened design for higher clamping force and wider opening widths
- Tommy bar with rounded ends for simple transfer of force when clamping
- Pressure plates can be replaced by hand – no tools required
- Stable profiled rail with serration
- BESSEY anti-slip system

Malleable cast iron screw clamps

- Clamping force up to 5,500 N
- High-quality 2-component plastic handle
- With protective caps on the clamping surfaces
- Stable profiled rail with serration



Malleable cast iron screw clamp TPN with 2-component plastic handle

| № | <a> | | <x> | ⚖ | 📦 | V1 |
|---------------|------|-----|---------|------|------|----|
| | mm | mm | mm | kg | qty. | |
| TPN16BE-2K | 160 | 80 | 25 x 6 | 0.73 | 10 | |
| TPN20BE-2K | 200 | 100 | 27 x 7 | 1.06 | 10 | |
| TPN25BE-2K | 250 | 120 | 29 x 9 | 1.50 | 10 | |
| TPN40S12BE-2K | 400 | 120 | 29 x 9 | 1.74 | 10 | |
| TPN50S12BE-2K | 500 | 120 | 29 x 9 | 2.00 | 10 | |
| TPN60S12BE-2K | 600 | 120 | 29 x 9 | 2.10 | 5 | |
| TPN80S12BE-2K | 800 | 120 | 29 x 9 | 2.50 | 5 | |
| TP100S12BE-2K | 1000 | 120 | 29 x 9 | 2.80 | 5 | |
| TPN30BE-2K | 300 | 140 | 32 x 10 | 2.03 | 10 | |
| TPN40BE-2K | 400 | 175 | 32 x 10 | 2.61 | 5 | |



- Clamping force up to 5,500 N
- Ergonomically shaped wood handle
- With protective caps on the clamping surfaces
- Stable profiled rail with serration



Malleable cast iron screw clamp TPN with tried-and-true wooden handle

| № | <a> | | <x> | ⚖ | 📦 | V1 |
|------------|------|-----|---------|------|------|----|
| | mm | mm | mm | kg | qty. | |
| TPN10BE | 100 | 50 | 15 x 5 | 0.26 | 10 | |
| TPN15B5BE | 150 | 50 | 15 x 5 | 0.29 | 10 | |
| TPN20B5BE | 200 | 50 | 15 x 5 | 0.31 | 10 | |
| TPN12BE | 120 | 60 | 20 x 5 | 0.40 | 10 | |
| TPN20B6BE | 200 | 60 | 20 x 5 | 0.45 | 10 | |
| TPN16BE | 160 | 80 | 25 x 6 | 0.73 | 10 | |
| TPN20B8BE | 200 | 80 | 25 x 6 | 0.77 | 10 | |
| TPN25B8BE | 250 | 80 | 25 x 6 | 0.82 | 10 | |
| TPN30B8BE | 300 | 80 | 25 x 6 | 0.87 | 10 | |
| TPN20BE | 200 | 100 | 27 x 7 | 1.16 | 10 | |
| TPN25S10BE | 250 | 100 | 27 x 7 | 1.23 | 10 | |
| TPN30S10BE | 300 | 100 | 27 x 7 | 1.29 | 10 | |
| TPN40S10BE | 400 | 100 | 27 x 7 | 1.41 | 10 | |
| TPN50S10BE | 500 | 100 | 27 x 7 | 1.45 | 10 | |
| TPN60S10BE | 600 | 100 | 27 x 7 | 1.59 | 10 | |
| TPN25BE | 250 | 120 | 29 x 9 | 1.49 | 10 | |
| TPN30S12BE | 300 | 120 | 29 x 9 | 1.58 | 10 | |
| TPN40S12BE | 400 | 120 | 29 x 9 | 1.75 | 10 | |
| TPN50S12BE | 500 | 120 | 29 x 9 | 1.92 | 10 | |
| TPN60S12BE | 600 | 120 | 29 x 9 | 2.07 | 5 | |
| TPN80S12BE | 800 | 120 | 29 x 9 | 2.45 | 5 | |
| TP100S12BE | 1000 | 120 | 29 x 9 | 2.78 | 5 | |
| TP125S12BE | 1250 | 120 | 29 x 9 | 3.20 | 5 | |
| TP150S12BE | 1500 | 120 | 29 x 9 | 3.66 | 5 | |
| TPN30BE | 300 | 140 | 32 x 10 | 2.03 | 10 | |
| TPN40S14BE | 400 | 140 | 32 x 10 | 2.30 | 5 | |
| TPN50S14BE | 500 | 140 | 32 x 10 | 2.48 | 5 | |
| TPN60S14BE | 600 | 140 | 32 x 10 | 2.66 | 5 | |
| TPN80S14BE | 800 | 140 | 32 x 10 | 3.12 | 5 | |
| TP100S14BE | 1000 | 140 | 32 x 10 | 3.59 | 5 | |
| TP150S14BE | 1500 | 140 | 32 x 10 | 4.68 | 1 | |
| TP200S14BE | 2000 | 140 | 32 x 10 | 5.74 | 1 | |
| TPN40BE | 400 | 175 | 32 x 10 | 2.58 | 5 | |
| TPN60S17BE | 600 | 175 | 32 x 10 | 3.02 | 5 | |
| TPN80S17BE | 800 | 175 | 32 x 10 | 3.44 | 5 | |
| TP100S17BE | 1000 | 175 | 32 x 10 | 3.85 | 5 | |

Malleable cast iron screw clamps



Heavy duty malleable cast iron screw clamp TKPN with tried-and-true wooden handle



| № | ←a→ | ←b→ | ←x→ | ⚖ | 📦 | V1 |
|-----------|------|-----|---------|------|------|----|
| | mm | mm | mm | kg | qty. | |
| TKPN50BE | 500 | 120 | 35 x 11 | 2.21 | 5 | |
| TKPN60BE | 600 | 120 | 35 x 11 | 2.97 | 5 | |
| TKPN80BE | 800 | 120 | 35 x 11 | 3.48 | 5 | |
| TKPN100BE | 1000 | 120 | 35 x 11 | 4.05 | 5 | |
| TKPN125BE | 1250 | 120 | 35 x 11 | 4.65 | 1 | |
| TKPN150BE | 1500 | 120 | 35 x 11 | 5.34 | 1 | |
| TKPN200BE | 2000 | 120 | 35 x 11 | 6.67 | 1 | |
| TKPN250BE | 2500 | 120 | 35 x 11 | 7.96 | 1 | |
| TKPN300BE | 3000 | 120 | 35 x 11 | 9.20 | 1 | |



Malleable cast iron screw clamp TGRC with tried-and-true wooden handle



| № | ←a→ | ←b→ | ←x→ | ⚖ | 📦 | V1 |
|------------|------|-----|---------|------|------|----|
| | mm | mm | mm | kg | qty. | |
| TGRC10 | 100 | 50 | 15 x 5 | 0.26 | 10 | |
| TGRC15B5 | 150 | 50 | 15 x 5 | 0.29 | 10 | |
| TGRC20B5 | 200 | 50 | 15 x 5 | 0.31 | 10 | |
| TGRC12 | 120 | 60 | 20 x 5 | 0.43 | 10 | |
| TGRC20B6 | 200 | 60 | 20 x 5 | 0.49 | 10 | |
| TGRC30B6 | 300 | 60 | 20 x 5 | 0.56 | 10 | |
| TGRC16 | 160 | 80 | 25 x 6 | 0.73 | 10 | |
| TGRC20B8 | 200 | 80 | 25 x 6 | 0.77 | 10 | |
| TGRC25B8 | 250 | 80 | 25 x 6 | 0.82 | 10 | |
| TGRC30B8 | 300 | 80 | 25 x 6 | 0.87 | 10 | |
| TGRC20 | 200 | 100 | 27 x 7 | 1.19 | 10 | |
| TGRC25S10 | 250 | 100 | 27 x 7 | 1.28 | 10 | |
| TGRC30S10 | 300 | 100 | 27 x 7 | 1.33 | 10 | |
| TGRC40S10 | 400 | 100 | 27 x 7 | 1.43 | 10 | |
| TGRC25 | 250 | 120 | 29 x 9 | 1.54 | 10 | |
| TGRC30S12 | 300 | 120 | 29 x 9 | 1.63 | 10 | |
| TGRC40S12 | 400 | 120 | 29 x 9 | 1.80 | 10 | |
| TGRC50S12 | 500 | 120 | 29 x 9 | 2.05 | 10 | |
| TGRC60S12 | 600 | 120 | 29 x 9 | 2.24 | 5 | |
| TGRC80S12 | 800 | 120 | 29 x 9 | 2.62 | 5 | |
| TGRC100S12 | 1000 | 120 | 29 x 9 | 2.85 | 5 | |
| TGRC30 | 300 | 140 | 32 x 10 | 2.10 | 10 | |
| TGRC40S14 | 400 | 140 | 32 x 10 | 2.40 | 5 | |
| TGRC50S14 | 500 | 140 | 32 x 10 | 2.24 | 5 | |
| TGRC60S14 | 600 | 140 | 32 x 10 | 2.90 | 5 | |
| TGRC80S14 | 800 | 140 | 32 x 10 | 3.38 | 5 | |
| TGRC100S14 | 1000 | 140 | 32 x 10 | 3.78 | 5 | |
| TGRC150S14 | 1500 | 140 | 32 x 10 | 5.02 | 1 | |
| TGRC40 | 400 | 175 | 32 x 10 | 2.67 | 5 | |
| TGRC50S17 | 500 | 175 | 32 x 10 | 2.93 | 1 | |
| TGRC60S17 | 600 | 175 | 32 x 10 | 3.17 | 1 | |
| TGRC80S17 | 800 | 175 | 32 x 10 | 3.50 | 1 | |
| TGRC100S17 | 1000 | 175 | 32 x 10 | 4.00 | 1 | |

- Clamping force up to 6,500 N
- Strengthened design for higher clamping force and wider opening widths
- Ergonomically shaped wood handle
- Stable profiled rail with serration



- Clamping force up to 5,500 N
- Ergonomically shaped wood handle
- With protective caps on the clamping surfaces
- Stable solid flat rail with serration

Malleable cast iron screw clamps



- Clamping force up to 6,500 N
- Strengthened design for higher clamping force and wider opening widths
- Ergonomically shaped wood handle
- Stable solid flat rail with serration



Heavy duty malleable cast iron screw clamp TGKR with tried-and-true wooden handle

| № | <a> | | <x> | ⚖ | 📦 | V1 |
|---------|------|-----|---------|------|------|----|
| | mm | mm | mm | kg | qty. | |
| TGKR50 | 500 | 120 | 35 x 11 | 2.70 | 5 | |
| TGKR60 | 600 | 120 | 35 x 11 | 2.90 | 5 | |
| TGKR80 | 800 | 120 | 35 x 11 | 3.50 | 5 | |
| TGKR100 | 1000 | 120 | 35 x 11 | 4.00 | 5 | |
| TGKR125 | 1250 | 120 | 35 x 11 | 4.70 | 1 | |
| TGKR150 | 1500 | 120 | 35 x 11 | 5.20 | 1 | |
| TGKR200 | 2000 | 120 | 35 x 11 | 6.50 | 1 | |

Malleable cast iron screw clamps



Deep throat clamp TGNT with tried-and-true wooden handle



| № | <a> | | <x> | ⚖ | 📦 | V1 |
|-----------|------|-----|---------|-------|------|----|
| | mm | mm | mm | kg | qty. | |
| TGN30T20 | 300 | 200 | 35 x 11 | 3.11 | 1 | |
| TGN40T20 | 400 | 200 | 35 x 11 | 3.36 | 1 | |
| TGN60T20 | 600 | 200 | 35 x 11 | 3.91 | 1 | |
| TGN80T20 | 800 | 200 | 35 x 11 | 4.48 | 1 | |
| TGN100T20 | 1000 | 200 | 35 x 11 | 4.65 | 1 | |
| TGN40T25 | 400 | 250 | 40 x 11 | 4.42 | 1 | |
| TGN60T25 | 600 | 250 | 40 x 11 | 5.06 | 1 | |
| TGN80T25 | 800 | 250 | 40 x 11 | 5.71 | 1 | |
| TGN100T25 | 1000 | 250 | 40 x 11 | 6.34 | 1 | |
| TGN40T30 | 400 | 300 | 45 x 12 | 5.55 | 1 | |
| TGN60T30 | 600 | 300 | 45 x 12 | 6.31 | 1 | |
| TGN80T30 | 800 | 300 | 45 x 12 | 7.11 | 1 | |
| TGN100T30 | 1000 | 300 | 45 x 12 | 7.94 | 1 | |
| TGN150T30 | 1500 | 300 | 45 x 12 | 10.00 | 1 | |
| TGN200T30 | 2000 | 300 | 45 x 12 | 11.97 | 1 | |
| TGN250T30 | 2500 | 300 | 45 x 12 | 13.96 | 1 | |
| TGN40T40 | 400 | 400 | 45 x 12 | 6.70 | 1 | |
| TGN60T40 | 600 | 400 | 45 x 12 | 7.45 | 1 | |
| TGN80T40 | 800 | 400 | 45 x 12 | 8.27 | 1 | |
| TGN100T40 | 1000 | 400 | 45 x 12 | 9.22 | 1 | |
| TGN30T50 | 300 | 500 | 45 x 12 | 7.97 | 1 | |
| TGN60T50 | 600 | 500 | 45 x 12 | 9.17 | 1 | |
| TGN80T50 | 800 | 500 | 45 x 12 | 9.96 | 1 | |



- Clamping force up to 7,000 N
- Heavy-duty design
- Ergonomically shaped wood handle
- Large, stable solid flat rail with serration
- Rail dimensions great than and equal to 40 x 11 are ungalvanized



Deep throat screw clamp TGNT with tommy bar



| № | <a> | | <x> | ⚖ | 📦 | V1 |
|-----------|-----|-----|---------|------|------|----|
| | mm | mm | mm | kg | qty. | |
| TGN30T20K | 300 | 200 | 35 x 11 | 3.00 | 1 | |
| TGN40T20K | 400 | 200 | 35 x 11 | 3.21 | 1 | |
| TGN40T25K | 400 | 250 | 40 x 11 | 4.36 | 1 | |
| TGN60T25K | 600 | 250 | 40 x 11 | 4.98 | 1 | |
| TGN80T25K | 800 | 250 | 40 x 11 | 5.64 | 1 | |
| TGN40T30K | 400 | 300 | 45 x 12 | 5.48 | 1 | |
| TGN60T30K | 600 | 300 | 45 x 12 | 6.23 | 1 | |
| TGN80T30K | 800 | 300 | 45 x 12 | 7.06 | 1 | |
| TGN40T40K | 400 | 400 | 45 x 12 | 5.50 | 1 | |
| TGN60T40K | 600 | 400 | 45 x 12 | 7.39 | 1 | |
| TGN80T40K | 800 | 400 | 45 x 12 | 8.19 | 1 | |
| TGN30T50K | 300 | 500 | 45 x 12 | 7.87 | 1 | |
| TGN60T50K | 600 | 500 | 45 x 12 | 9.10 | 1 | |
| TGN80T50K | 800 | 500 | 45 x 12 | 9.91 | 1 | |

- Clamping force up to 7,000 N
- Heavy-duty design
- Tommy bar with rounded ends for simple transfer of force when clamping
- Large, stable solid plain rail with fluting
- Rail dimensions great than and equal to 40 x 11 are ungalvanized

All-steel screw clamps

Clamp that are resilient, elastic and powerful



The inspiration for many innovative clamping tools

The original BESSEY all-steel screw clamps are the perfect step up from the original BESSEY malleable cast iron screw clamps. They clamp resiliently and elastically, making them an essential aid when you want your tools to cover a wide range of applications. In addition, the all-steel screw clamp is a model for many other innovative BESSEY clamping tools – e.g. lever clamps, high-performance clamps, area pressure clamps, one-handed clamps and rafter clamps.

The OMEGA GMZ screw clamp offers maximum flexibility and safety thanks to its unique, patented OMEGA bend, which maintains the clamping pressure for longer, even when the all-steel screw clamp is shaken by vibrations. It also ensures that sensitive surfaces receive the necessary protection because the clamping pressure can be selected even more precisely. As with all all-steel screw clamps, it can also be used for any application, either for processing wood or metal. You can be sure of it!

GZ all-steel screw clamp – all models are equipped with an optimised rail profile and replaceable pressure plate.

The OMEGA screw clamp GMZ – universally applicable, for everything from wood to metal processing.

All-steel screw clamps



All-steel screw clamps

BESSEY's unrivalled all-steel quality

You Tube



Light, easy to handle and strong

Whether you choose the 2-component plastic handle, the wooden handle or the tommy bar, you're guaranteed satisfaction if you opt for an original BESSEY all-steel screw clamp. Especially thanks to BESSEY unique quality steel. With BESSEY you can be sure of an extremely high-quality, durable clamping tool which is also light and easy-to-handle. Even at the high clamping force, it will retain its dimensions and resist distortion. So in future, if you are looking for a powerful, flexible clamping effect, then what you need is a BESSEY all-steel screw clamp!

Your benefits at a glance:

1 Maximum stability

The optimised profile shape guarantees greater clamping force build-up in the shortest time, while maintaining greater stability and safety. The fixed clamp forged from a single piece with moulded pressure plate is hardened, tempered and galvanised, making it highly durable and torsion-resistant.

2 Forged sliding arm

The sliding arm allows for more efficient transfer of force. As a result of its more linear transfer of force, the new U-shaped sliding arm offers maximum security with the heaviest of loads. You can rely on that.

3 Pressure plate

For enhanced serviceability the pressure plate can be changed with no need for tools. It can be replaced very easily and quickly.

4 Smooth-running spindle

The surface-coated spindle with acme thread is particularly smooth-running, and does not bind. For even smoother, more efficient work.

20 % more clamping force
per spindle rotation

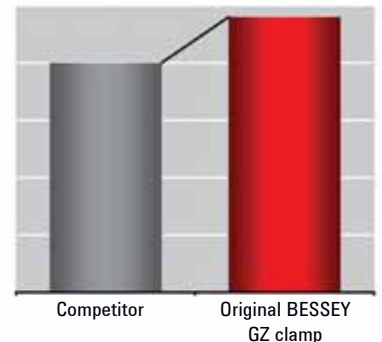

All-steel screw clamps



Original BESSEY all-steel screw clamp GZ with 2-component plastic handle

| № | ←a→ | ←b→ | ←x→ | kg | qty. | V2 |
|-------------|------|-----|------------|------|------|----|
| | mm | mm | mm | | | |
| GZ10-2K | 100 | 60 | 15 x 6 | 0.31 | 10 | |
| GZ12-2K | 120 | 60 | 15 x 6 | 0.32 | 10 | |
| GZ16-2K | 160 | 80 | 17.5 x 6.8 | 0.57 | 10 | |
| GZ40-8-2K | 400 | 80 | 17.5 x 6.8 | 0.76 | 10 | |
| GZ20-2K | 200 | 100 | 22 x 8.5 | 1.01 | 10 | |
| GZ25-2K | 250 | 120 | 24.5 x 9.5 | 1.38 | 10 | |
| GZ30-12-2K | 300 | 120 | 24.5 x 9.5 | 1.46 | 10 | |
| GZ40-12-2K | 400 | 120 | 24.5 x 9.5 | 1.62 | 10 | |
| GZ50-12-2K | 500 | 120 | 24.5 x 9.5 | 1.78 | 10 | |
| GZ60-12-2K | 600 | 120 | 24.5 x 9.5 | 1.95 | 5 | |
| GZ80-12-2K | 800 | 120 | 24.5 x 9.5 | 2.20 | 5 | |
| GZ100-12-2K | 1000 | 120 | 24.5 x 9.5 | 2.45 | 5 | |
| GZ30-2K | 300 | 140 | 28 x 11 | 1.98 | 10 | |
| GZ40-2K | 400 | 120 | 28 x 11 | 2.12 | 10 | |
| GZ50-2K | 500 | 120 | 28 x 11 | 2.30 | 5 | |
| GZ60-2K | 600 | 120 | 28 x 11 | 2.49 | 5 | |
| GZ80-2K | 800 | 120 | 28 x 11 | 2.36 | 5 | |
| GZ100-2K | 1000 | 120 | 28 x 11 | 3.25 | 5 | |
| GZ125-2K | 1250 | 120 | 28 x 11 | 3.79 | 1 | |



- 20 % more clamping force per spindle rotation with optimised rail profile
- Maximum security with linear transfer of force at the sliding arm
- Clamping force up to 6,000 N
- Fixed jaw and sliding arm are constructed of tempered steel for resilient clamping
- High-quality 2-component plastic handle
- Pressure plates can be replaced by hand – no need for tools (from 80 mm width)



Original BESSEY all-steel screw clamp GZ with tried-and-tested wooden handle

| № | ←a→ | ←b→ | ←x→ | kg | qty. | V2 |
|---------|------|-----|------------|------|------|----|
| | mm | mm | mm | | | |
| GZ10 | 100 | 60 | 15 x 6 | 0.30 | 10 | |
| GZ12 | 120 | 60 | 15 x 6 | 0.31 | 10 | |
| GZ30-6 | 300 | 60 | 15 x 6 | 0.42 | 10 | |
| GZ16 | 160 | 80 | 17.5 x 6.8 | 0.52 | 10 | |
| GZ20 | 200 | 100 | 22 x 8.5 | 0.95 | 10 | |
| GZ30-10 | 300 | 100 | 22 x 8.5 | 1.09 | 10 | |
| GZ25 | 250 | 120 | 24.5 x 9.5 | 1.34 | 10 | |
| GZ30-12 | 300 | 120 | 24.5 x 9.5 | 1.40 | 10 | |
| GZ40-12 | 400 | 120 | 24.5 x 9.5 | 1.56 | 10 | |
| GZ30 | 300 | 140 | 28 x 11 | 1.96 | 10 | |
| GZ40 | 400 | 120 | 28 x 11 | 2.04 | 10 | |
| GZ50 | 500 | 120 | 28 x 11 | 2.27 | 5 | |
| GZ60 | 600 | 120 | 28 x 11 | 2.47 | 5 | |
| GZ80 | 800 | 120 | 28 x 11 | 2.82 | 5 | |
| GZ100 | 1000 | 120 | 28 x 11 | 3.22 | 5 | |
| GZ125 | 1250 | 120 | 28 x 11 | 3.75 | 1 | |



- 20 % more clamping force per spindle rotation with optimised rail profile
- Maximum security with linear transfer of force at the sliding arm
- Clamping force up to 6,000 N
- Fixed jaw and sliding arm are constructed of tempered steel for resilient clamping
- Ergonomically shaped wood handle
- Pressure plates can be replaced by hand – no need for tools (from 80 mm width)

All-steel screw clamps

- 20 % more clamping force per spindle rotation with optimised rail profile
- Maximum security with linear transfer of force at the sliding arm
- Clamping force up to 6,000 N
- Fixed jaw and sliding arm are constructed of tempered steel for resilient clamping
- Tommy bar with rounded ends for simple transfer of force when clamping
- Pressure plates can be replaced by hand – no need for tools



Original BESSEY all-steel screw clamp GZ with tommy bar

| № | ←a→ | ←b→ | ←x→ | ⚖ | 📦 | V2 |
|----------|------|-----|------------|------|------|----|
| | mm | mm | mm | kg | qty. | |
| GZ16K | 160 | 80 | 17.5 x 6.8 | 0.50 | 10 | |
| GZ20K | 200 | 100 | 22 x 8.5 | 0.93 | 10 | |
| GZ30-10K | 300 | 100 | 22 x 8.5 | 1.06 | 10 | |
| GZ50-10K | 500 | 100 | 22 x 8.5 | 1.33 | 10 | |
| GZ25K | 250 | 120 | 24.5 x 9.5 | 1.31 | 10 | |
| GZ30K | 300 | 140 | 28 x 11 | 1.89 | 10 | |
| GZ40K | 400 | 120 | 28 x 11 | 2.00 | 10 | |
| GZ50K | 500 | 120 | 28 x 11 | 2.20 | 5 | |
| GZ60K | 600 | 120 | 28 x 11 | 2.40 | 5 | |
| GZ80K | 800 | 120 | 28 x 11 | 2.76 | 5 | |
| GZ100K | 1000 | 120 | 28 x 11 | 3.18 | 5 | |
| GZ125K | 1250 | 120 | 28 x 11 | 3.65 | 1 | |

NEW



Original BESSEY all-steel screw clamp GZ with swivel handle

| № | ←a→ | ←b→ | ←x→ | ⚖ | 📦 | V2 |
|-----------|-----|-----|------------|------|------|----|
| | mm | mm | mm | kg | qty. | |
| GZ25KG | 250 | 120 | 24.5 x 9.5 | 1.42 | 10 | |
| GZ30-12KG | 300 | 120 | 24.5 x 9.5 | 1.50 | 10 | |
| GZ40-12KG | 400 | 120 | 24.5 x 9.5 | 1.69 | 10 | |
| GZ50-12KG | 500 | 120 | 24.5 x 9.5 | 1.82 | 10 | |
| GZ60-12KG | 600 | 120 | 24.5 x 9.5 | 1.99 | 5 | |

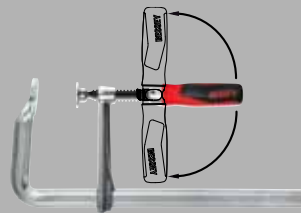

- Clamping force up to 5,000 N
- Fixed jaw and sliding arm are constructed of tempered steel for resilient clamping
- High-quality 2-component plastic handle
- Swivel handle can be folded 90° and rotated 360° without obstruction – even in areas that are difficult to reach
- Pressure plates can be replaced by hand – no need for tools

You Tube



- For screw clamps
- For gentle clamping
- May be applied on both sides
- Cut them to size



Pressure cap strips SKS (2 pcs./bag)

| № | Suitable for | V3 |
|----------|--|----|
| | SKS10/20 | |
| SKS20/40 | TG20 to TG40 / TGK / GZ20 to GZ60 / GM20Z to GM60Z | |

All-steel screw clamps



All-steel screw clamp classiX GS with tried-and-tested wooden handle



| N ^o | ←a→ | ←b→ | ←x→ | ⚖ | 📦 | V2 |
|----------------|------|-----|------------|------|------|----|
| | mm | mm | mm | kg | qty. | |
| GS10 | 100 | 50 | 11.5 x 5.6 | 0.20 | 10 | |
| GS12 | 120 | 60 | 13.5 x 6.5 | 0.30 | 10 | |
| GS16 | 160 | 80 | 16 x 7.5 | 0.48 | 10 | |
| GS20 | 200 | 100 | 19.5 x 9.5 | 0.83 | 10 | |
| GS25 | 250 | 120 | 22 x 10.5 | 1.30 | 10 | |
| GS30 | 300 | 140 | 25 x 12 | 1.85 | 10 | |
| GS40 | 400 | 120 | 25 x 12 | 1.95 | 10 | |
| GS50 | 500 | 120 | 25 x 12 | 2.20 | 5 | |
| GS60 | 600 | 120 | 25 x 12 | 2.40 | 5 | |
| GS80 | 800 | 120 | 27 x 13 | 3.17 | 5 | |
| GS100 | 1000 | 120 | 27 x 13 | 3.60 | 5 | |



- Clamping force up to 5,000 N
- Fixed jaw and sliding arm are constructed of tempered steel for resilient clamping
- Ergonomically shaped wood handle



All-steel screw clamp classiX GS with tommy bar



| N ^o | ←a→ | ←b→ | ←x→ | ⚖ | 📦 | V2 |
|----------------|------|-----|------------|------|------|----|
| | mm | mm | mm | kg | qty. | |
| GS16K | 160 | 80 | 16 x 7.5 | 0.46 | 10 | |
| GS20K | 200 | 100 | 19.5 x 9.5 | 0.83 | 10 | |
| GS25K | 250 | 120 | 22 x 10.5 | 1.20 | 10 | |
| GS30K | 300 | 140 | 25 x 12 | 1.79 | 10 | |
| GS40K | 400 | 120 | 25 x 12 | 1.95 | 10 | |
| GS50K | 500 | 120 | 25 x 12 | 2.17 | 5 | |
| GS60K | 600 | 120 | 25 x 12 | 2.37 | 5 | |
| GS80K | 800 | 120 | 27 x 13 | 3.11 | 5 | |
| GS100K | 1000 | 120 | 27 x 13 | 3.58 | 5 | |

- Clamping force up to 5,000 N
- Fixed jaw and sliding arm are constructed of tempered steel for resilient clamping
- Tommy bar with rounded ends for simple transfer of force when clamping

Comparison of the first and second line on Original BESSEY all-steel screw clamps

| Order no. | Original BESSEY all-steel screw clamps | | | | classiX | |
|------------------------------|---|----------------|----------------|----------------|---------------|---------------|
| | GZ...2K | GZ... | GZ...K | GZ...KG | GS | GS...K |
| | | | | | | |
| Product range | +++ | +++ | +++ | +++ | ++ | ++ |
| Clamping width | 100-1,250 mm | 100-1,250 mm | 160-1,250 mm | 250-600 mm | 100-1,000 mm | 160-1,000 mm |
| Throat depth | 60-140 mm | 60-140 mm | 80-140 mm | 120 mm | 50-140 mm | 80-140 mm |
| Optimised rail profile | ✓ | ✓ | ✓ | ✓ | | |
| Clamping force up to | +++ 6,000 N | +++ 6,000 N | +++ 6,000 N | +++ 5,000 N | ++ 5,000 N | ++ 5,000 N |
| Changeable pressure plate | ✓ | ✓ | ✓ | ✓ | | |
| Intellectual property rights | on rail, sliding arm, pressure plate and appearance | | | | | |

All-steel screw clamps

It has a reserve of power, with the patented OMEGA bend

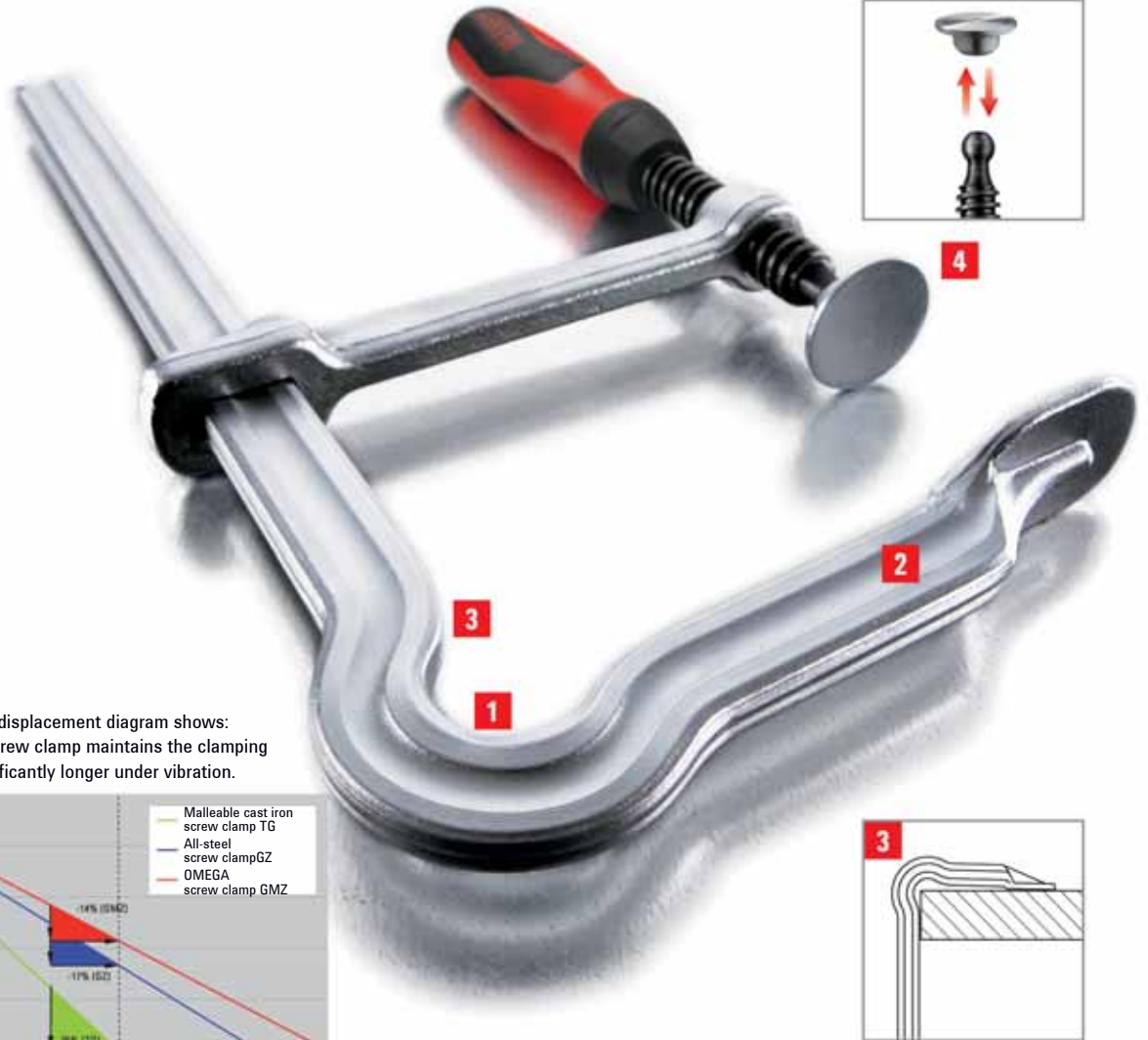

The load-displacement diagram shows: the OMEGA screw clamp maintains the clamping force significantly longer under vibration.

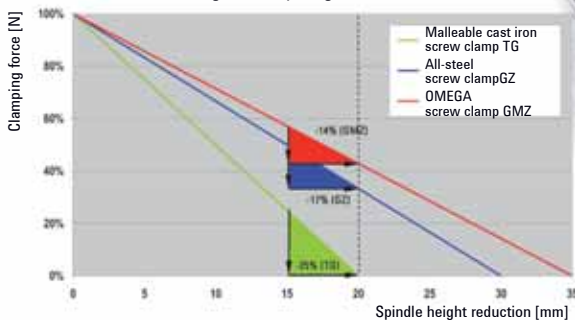

Greater safety with the OMEGA-bend

The unique, patented OMEGA-bend increases the spring deflection of the OMEGA-screw clamp. The decrease in pressure at the point of clamping (...per spindle rotation) is significantly lower with the BESSEY OMEGA clamp than with a comparable malleable cast iron or all-steel screw clamp (see diagram). That means that, even when vibrations are present, this clamp will maintain its clamping pressure longer than a conventional screw, thereby offering greater working safety. Don't settle for less!

Your benefits at a glance:

- 1 Innovative OMEGA bend**
The patented OMEGA bend gives you added safety. It means you lose even less clamping pressure, even when vibrations are present.
- 2 Maximum flexibility**
The clamp forged from a single piece with moulded pressure plate is hardened, tempered and galvanised, making it highly durable and torsion-resistant. The clamps clamp resiliently and elastically.

3 Close flat clamping

The OMEGA bend allows you to place the clamp absolutely flat to the surface of the workpiece. This allows clamping right into the corners.

4 Pressure plate

For enhanced serviceability the pressure plate can be changed with no need for tools. It can be replaced very easily and quickly.

All-steel screw clamps



OMEGA screw clamp GMZ with 2-component plastic handle



| № | ←a→ | ←b→ | ←x→ | ⚖ | 📦 | V2 |
|----------|-----|-----|------------|------|------|----|
| | mm | mm | mm | kg | qty. | |
| GM16Z-2K | 160 | 80 | 16 x 7.5 | 0.55 | 10 | |
| GM20Z-2K | 200 | 100 | 19.5 x 9.5 | 0.94 | 10 | |
| GM25Z-2K | 250 | 120 | 22 x 10.5 | 1.35 | 10 | |
| GM30Z-2K | 300 | 140 | 25 x 12 | 1.91 | 10 | |
| GM40Z-2K | 400 | 120 | 25 x 12 | 2.08 | 10 | |
| GM50Z-2K | 500 | 120 | 25 x 12 | 2.29 | 5 | |
| GM60Z-2K | 600 | 120 | 25 x 12 | 2.46 | 5 | |



- Clamping force up to 5,000 N
- Fixed jaw with patented OMEGA bow for less clamping force loss
- Fixed jaw and sliding arm are constructed of tempered steel for resilient clamping
- High-quality 2-component plastic handle
- Pressure plates can be replaced with no need for tools



OMEGA-screw clamp GMZ with tommy bar



| № | ←a→ | ←b→ | ←x→ | ⚖ | 📦 | V2 |
|--------|-----|-----|------------|------|------|----|
| | mm | mm | mm | kg | qty. | |
| GM20ZK | 200 | 100 | 19.5 x 9.5 | 0.88 | 10 | |
| GM25ZK | 250 | 120 | 22 x 10.5 | 1.25 | 10 | |
| GM30ZK | 300 | 140 | 25 x 12 | 1.84 | 10 | |
| GM50ZK | 500 | 120 | 25 x 12 | 2.22 | 5 | |
| GM60ZK | 600 | 120 | 25 x 12 | 2.42 | 5 | |

- Clamping force up to 5,000 N
- Fixed jaw with patented OMEGA bow for less clamping force loss
- Fixed jaw and sliding arm are constructed of tempered steel for resilient clamping
- Tommy bar with rounded ends for simple transfer of force when clamping
- Pressure plates can be replaced with no need for tools

Pressure cap strips SKS (2 pcs./bag)



| № | Suitable for | V3 |
|----------|--|----|
| | SKS10/20 | |
| SKS20/40 | TG20 to TG40 / TGK / GZ20 to GZ60 / GM20Z to GM60Z | |

- For screw clamps
- For gentle clamping
- May be applied on both sides
- Cut them to size

Lever clamps

Clamping with leverage – speed, safety and strength



The quick, secure, powerful clamping tool

The original BESSEY lever clamps are lightweight, easy to handle, dimensionally stable, and torsion-resistant. And the best thing is: they can clamp and release up to 5 x faster than conventional clamps. This is because they use the natural force of the lever, meaning that with just a small amount of effort they can quickly produce large clamping

pressures. In addition, the optimised rail profile with greater reserves of force enables a more even application of force – especially under full utilisation of clamping range. The original BESSEY lever clamps are particularly valuable in situations where many clamps have to be applied in a short time, with no risk of loosening due to vibration. Try it out!

The lever clamp GH – allows you to clamp up to 5 x faster than with conventional clamps.

The SGHS lever clamp – the heavy duty version with a clamping force of up to 9,500 N.

You Tube

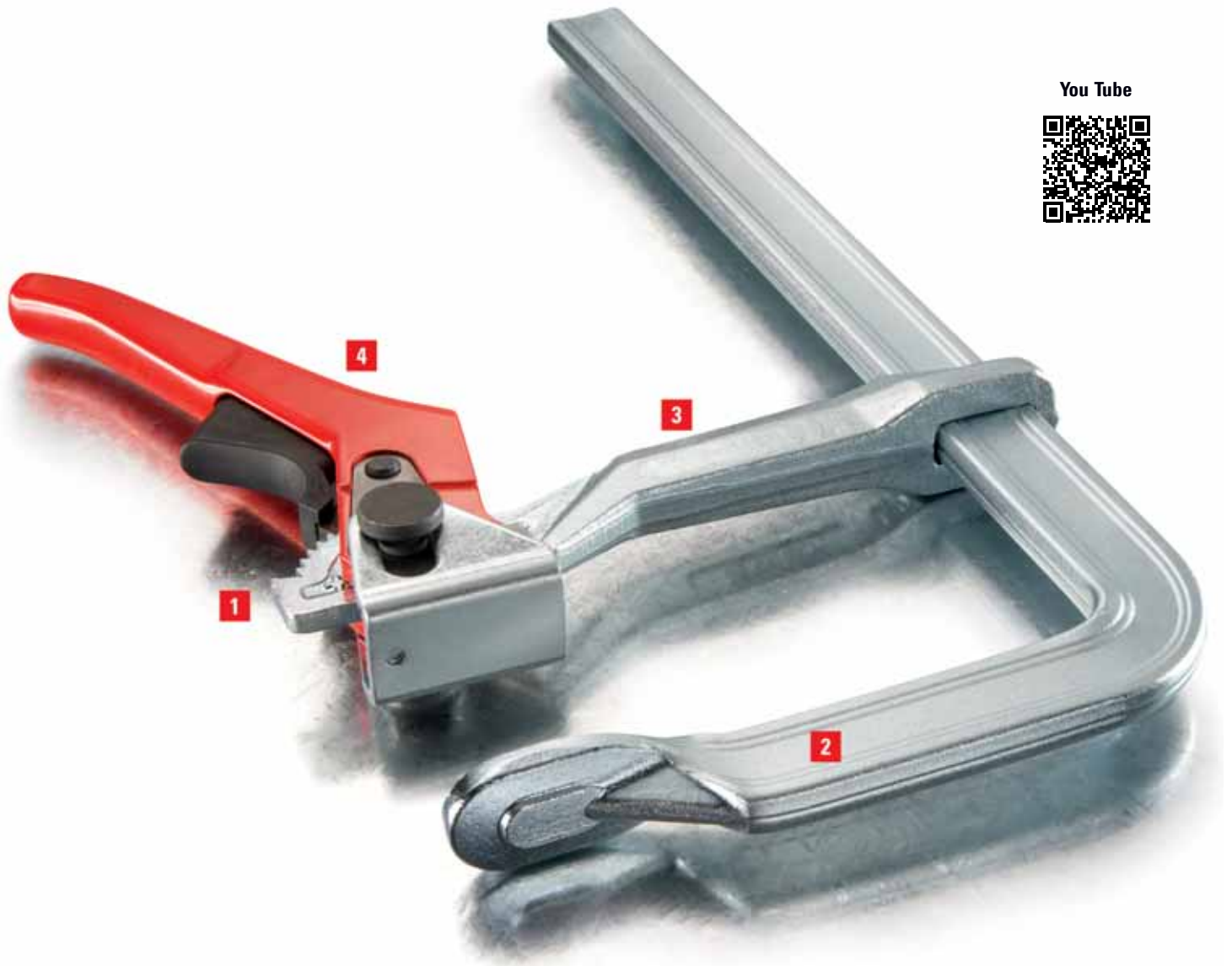

Your benefits at a glance:

1 Secure ratchet mechanism

The ratchet mechanism ensures rapid, controlled, vibration-free clamping. A hardened cam at the end of the lever ensures a long service life.

2 Maximum stability

The optimised profile shape with greater reserves of force enables a more even application of force – especially under full utilisation of clamping width. The fixed clamp forged from a single piece with moulded pressure plate is hardened, tempered and galvanised, making it highly durable and torsion-resistant.

3 Forged sliding arm

The sliding arm is serrated and made from tempered, drop-forged steel. For an extremely long service life.

4 Ergonomic clamping and release lever

The powder-coated clamping lever has a particularly ergonomic shape. The plastic-coated non-slip release lever provides a secure hold as you release the clamp.

Lever clamps



- Greater reserves of power, thanks to optimised rail profile, for even clamping force build-up, especially under maximum utilisation of the clamping range
- Non-slip trigger release
- Sintered steel cams – particularly hard-wearing, low friction due to higher surface hardness
- Quick – up to 5 x faster than regular clamps
- Secure – vibration resistant
- Strong – clamping force up to 8,500 N



Lever clamp GH

| № | ←a→ | ←b→ | ←x→ | ⚖ | 📦 | V2 |
|---------|------|-----|------------|------|------|----|
| | mm | mm | mm | kg | qty. | |
| GH12 | 120 | 60 | 15 x 6 | 0.49 | 10 | |
| GH16 | 160 | 80 | 17.5 x 6.8 | 0.64 | 10 | |
| GH20-8 | 200 | 80 | 17.5 x 6.8 | 0.68 | 10 | |
| GH20 | 200 | 100 | 22 x 8.5 | 1.11 | 10 | |
| GH25 | 250 | 120 | 24.5 x 9.5 | 1.44 | 10 | |
| GH30-12 | 300 | 120 | 24.5 x 9.5 | 1.51 | 10 | |
| GH40-12 | 400 | 120 | 24.5 x 9.5 | 1.67 | 10 | |
| GH30 | 300 | 140 | 28 x 11 | 2.22 | 10 | |
| GH40 | 400 | 120 | 28 x 11 | 2.39 | 10 | |
| GH50 | 500 | 120 | 28 x 11 | 2.61 | 5 | |
| GH60 | 600 | 120 | 28 x 11 | 2.78 | 5 | |
| GH80 | 800 | 120 | 28 x 11 | 3.14 | 5 | |
| GH100 | 1000 | 120 | 28 x 11 | 3.57 | 5 | |



- Heavy design
- Rapid – up to 5 x faster than conventional clamps
- Secure – vibration resistant
- Strong – clamping force up to 9,500 N



Lever clamp SGHS, heavy duty

| № | ←a→ | ←b→ | ←x→ | ⚖ | 📦 | V2 |
|---------|-----|-----|---------|------|------|----|
| | mm | mm | mm | kg | qty. | |
| SG-25HS | 300 | 140 | 30 x 15 | 3.05 | 5 | |
| SG-50HS | 500 | 140 | 30 x 15 | 3.83 | 5 | |

Lever clamps



Lever clamp classiX GSH



| Nº | ←a→ mm | ←b→ mm | ←x→ mm | ⚖️ kg | 📦 qty. | V2 |
|-------|-----------|-----------|------------|----------|-----------|----|
| GSH12 | 120 | 60 | 13.5 x 6.5 | 0.49 | 10 | |
| GSH16 | 160 | 80 | 16 x 7.5 | 0.64 | 10 | |
| GSH20 | 200 | 100 | 19.5 x 9.5 | 1.08 | 10 | |
| GSH25 | 250 | 120 | 22 x 10.5 | 1.44 | 10 | |
| GSH30 | 300 | 140 | 25 x 12 | 2.22 | 10 | |
| GSH40 | 400 | 120 | 25 x 12 | 2.41 | 10 | |
| GSH50 | 500 | 120 | 25 x 12 | 2.59 | 5 | |
| GSH60 | 600 | 120 | 25 x 12 | 2.79 | 5 | |



- Non-slip trigger release
- Quick – up to 5 times faster than regular clamps
- Secure – unaffected by vibrations
- Strong – clamping force up to 7,500 N

Comparison of the first and second line on BESSEY lever clamps

| Order no. | BESSEY lever clamps | classiX |
|------------------------------|---|---------------|
| | GH | GSH |
| | | |
| Product range | +++ | ++ |
| Clamping width | 120-1,000 mm | 120-600 mm |
| Throat depth | 60-140 mm | 60-140 mm |
| Optimised rail profile | ✓ | |
| Clamping force up to | +++ 8,500 N | ++ 7,500 N |
| Intellectual property rights | on rail, sliding arm, pressure plate and appearance | |

High-performance clamps

High-performance clamping



Clamping force of up to 35,000 N

Increasingly high clamping pressures with larger throat depths and wider openings. These are the daily requirements of the original BESSEY high-performance clamps. Applications include steel fabrication, welding, shipbuilding and automotive manufacturing as well as heavy timber con-

struction, wood laminations and general carpentry. In other words, wherever sturdy or heavy parts need to be clamped securely and with high clamping pressure. Developed on the basis of the tried-and-tested BESSEY all-steel screw clamp, the original BESSEY high-performance clamps fulfil all requirements with panache... again and again!

The high-performance clamp STBS – very sturdy and long-lasting, offering exceptional clamping pressures.

You Tube



20 % more clamping force
per spindle rotation

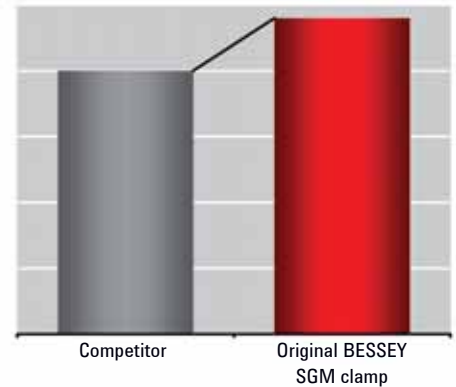

Your benefits at a glance:

1 Maximum stability

The optimised profile shape guarantees greater clamping force build-up in the shortest time, while maintaining greater stability and safety. The fixed clamp forged from a single piece with moulded pressure plate is hardened, tempered and galvanised, making it highly durable and torsion-resistant.

2 Forged sliding arm

The sliding arm has a shape that allows for more efficient transfer of force. As a result of its more linear transfer of force, the U-shaped sliding arm offers maximum security with the heaviest of loads. You can rely on that.

3 Special tilting pressure plate

The heat-resistant pressure plate is replaceable and can be tilted up to 35° so it can even clamp on angled or sloping surfaces. It has an extremely long service-life due to the oil-soaked sintered steel insert's excellent sliding and emergency running properties.

4 Tempered spindle

The tempered spindle is particularly sturdy and wear-resistant. This considerably increases its durability.

Improved rail profile means greater productivity

The innovative shape of the BESSEY rail profile and sliding arm provide a number of productivity enhancing benefits. These benefits include more clamping force per spindle rotation and more clamping stability for faster and safer work. Moreover, the shape of the rail profile and sliding arm guarantees better contact with the work surface at higher clamping forces. The BESSEY high-performance clamp is the ideal tool for your clamping jobs, day after day.

High-performance clamps



- Clamping force up to 8,500 N at tightening torque of 25 Nm
- 20 % more clamping force per spindle rotation with optimised rail profile
- Maximum safety due to the better linear transfer of force of the sliding arm
- Long life due to heat-resistant pressure plate with sintered steel insert, which can be tilted up to 35°



Fitters' clamp SLM



| № | <a> | | <x> | ⚖ | 📦 | V2 |
|-------|-----|-----|---------|------|------|----|
| | mm | mm | mm | kg | qty. | |
| SL20M | 200 | 120 | 28 x 11 | 1.81 | 5 | |
| SL25M | 250 | 120 | 28 x 11 | 1.91 | 5 | |
| SL30M | 300 | 120 | 28 x 11 | 2.00 | 5 | |
| SL40M | 400 | 120 | 28 x 11 | 2.20 | 5 | |
| SL50M | 500 | 120 | 28 x 11 | 2.41 | 5 | |
| SL60M | 600 | 120 | 28 x 11 | 2.61 | 5 | |



- Clamping force up to 12,000 N at tightening torque of 40 Nm
- 20 % more clamping force per spindle rotation with optimised rail profile
- Maximum safety due to the better linear transfer of force of the sliding arm
- Long life due to heat-resistant pressure plate with sintered steel insert, which can be tilted up to 35°



High-performance clamp SGM



| № | <a> | | <x> | ⚖ | 📦 | V2 |
|--------|------|-----|---------|------|------|----|
| | mm | mm | mm | kg | qty. | |
| SG25M | 250 | 140 | 34 x 13 | 2.58 | 5 | |
| SG30M | 300 | 140 | 34 x 13 | 3.03 | 5 | |
| SG40M | 400 | 140 | 34 x 13 | 3.17 | 5 | |
| SG50M | 500 | 140 | 34 x 13 | 3.40 | 5 | |
| SG60M | 600 | 140 | 34 x 13 | 3.80 | 5 | |
| SG80M | 800 | 140 | 34 x 13 | 4.45 | 5 | |
| SG100M | 1000 | 140 | 34 x 13 | 4.95 | 5 | |
| SG125M | 1250 | 140 | 34 x 13 | 5.87 | 1 | |
| SG150M | 1500 | 140 | 34 x 13 | 6.63 | 1 | |

High-performance clamps



High-performance clamp SGTM, large throat depth



| № | <a> | | <x> | ⚖️ | 📦 | V2 |
|----------|-----|-----|---------|------|------|----|
| | mm | mm | mm | kg | qty. | |
| SG30T20M | 300 | 200 | 30 x 15 | 3.39 | 1 | |
| SG60T20M | 600 | 200 | 30 x 15 | 4.30 | 1 | |

- Clamping force up to 8,500 N at tightening torque of 40 Nm
- Long life due to heat-resistant pressure plate with sintered steel insert, which can be tilted up to 35°
- Opening 200 mm



High-performance clamp STBM



| № | <a> | | <x> | ⚖️ | 📦 | V2 |
|---------|------|-----|---------|-------|------|----|
| | mm | mm | mm | kg | qty. | |
| STB30M | 300 | 175 | 40 x 20 | 5.61 | 1 | |
| STB40M | 400 | 175 | 40 x 20 | 6.10 | 1 | |
| STB50M | 500 | 175 | 40 x 20 | 6.67 | 1 | |
| STB60M | 600 | 175 | 40 x 20 | 7.23 | 1 | |
| STB80M | 800 | 175 | 40 x 20 | 8.35 | 1 | |
| STB100M | 1000 | 175 | 40 x 20 | 9.32 | 1 | |
| STB125M | 1250 | 175 | 40 x 20 | 10.77 | 1 | |
| STB150M | 1500 | 175 | 40 x 20 | 12.20 | 1 | |

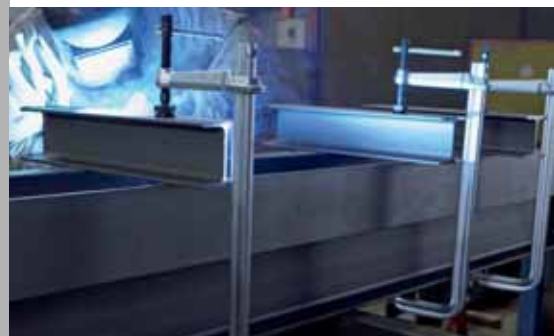

- Clamping force up to 22,000 N at tightening torque of 70 Nm
- Long life due to heat-resistant pressure plate with sintered steel insert, which can be tilted up to 35°
- With 19 mm hexagonal bolt on the end of the spindle



High-performance clamp STBS



| № | <a> | | <x> | ⚖️ | 📦 | V2 |
|---------|------|-----|---------|-------|------|----|
| | mm | mm | mm | kg | qty. | |
| STBS30 | 300 | 200 | 50 x 25 | 10.46 | 1 | |
| STBS50 | 500 | 200 | 50 x 25 | 12.17 | 1 | |
| STBS100 | 1000 | 200 | 50 x 25 | 16.68 | 1 | |

- Clamping force up to 35,000 N at tightening torque of 100 Nm
- Long life due to heat-resistant pressure plate with sintered steel insert, which can be tilted up to 35°
- With 36 mm hexagonal bolt on the end of the spindle
- With wedge for fixing the sliding arm

High-performance clamps



- Clamping force up to 35,000 N at tightening torque of 105 Nm
- Long life due to heat-resistant pressure plate with sintered steel insert, which can be tilted up to 35°
- With 19 mm hexagonal bolt on the end of the spindle
- With wedge for fixing the sliding arm



- Long life due to heat-resistant pressure plate with sintered steel insert, which can be tilted up to 35°
- Three design versions:
 - Smooth faced (standard version)
 - Rough faced for secure clamping on dirty surfaces
 - V-groove face for round, oval and edged workpieces



High-performance clamp STBVC

| N ^o | <a> | | <x> | ⚖️ | 📦 | V2 |
|----------------|-----|-----|---------|------|------|----|
| | mm | mm | mm | kg | qty. | |
| STBVC15 | 150 | 100 | 40 x 20 | 4.06 | 1 | |
| STBVC25 | 250 | 100 | 40 x 20 | 4.62 | 1 | |
| STBVC35 | 350 | 100 | 40 x 20 | 5.13 | 1 | |



Special pressure plate

| N ^o | Description | Suitable for | V3 |
|----------------|-------------|---|----|
| | | | |
| 3100736 | Standard | SLM, SGM, SGTM, STBM, STBVC, SGU, SLV, GSV, SPZ80K, TWM | |
| 3100737 | Standard | STBS, STBU | |
| 3101192 | Serrated | SLM, SGM, SGTM, STBM, STBVC, SGU, SLV, GSV, SPZ80K, TWM | |
| 3101193 | V-grooved | SLM, SGM, SGTM, STBM, STBVC, SGU, SLV, GSV, SPZ80K, TWM | |

High-performance clamps



Fitters' clamp classiX GSL



| № | <a> | | <x> | ⚖ | 📦 | V2 |
|-------|-----|-----|---------|------|------|----|
| | mm | mm | mm | kg | qty. | |
| GSL30 | 300 | 120 | 27 x 13 | 2.11 | 5 | |
| GSL60 | 600 | 120 | 27 x 13 | 2.82 | 5 | |



- Clamping force up to 7,500 N with a tightening torque of 25 Nm
- Special heat-resistant pressure plate, can be tilted by up to 35°



High-performance clamp classiX GSM



| № | <a> | | <x> | ⚖ | 📦 | V2 |
|-------|-----|-----|---------|------|------|----|
| | mm | mm | mm | kg | qty. | |
| GSM25 | 250 | 140 | 30 x 15 | 2.58 | 5 | |
| GSM30 | 300 | 140 | 30 x 15 | 3.00 | 5 | |
| GSM40 | 400 | 140 | 30 x 15 | 3.17 | 5 | |
| GSM50 | 500 | 140 | 30 x 15 | 3.40 | 5 | |
| GSM60 | 600 | 140 | 30 x 15 | 3.80 | 5 | |



- Clamping force up to 11,000 N with a tightening torque of 40 Nm
- Special heat-resistant pressure plate, can be tilted by up to 35°

Comparison of the first and second line on BESSEY high-performance clamps

| Order no. | BESSEY high-performance clamps | | classiX | |
|---|---|-------------------|---------------|-------------------|
| | SLM | SGM | GSL | GSM |
| | | | | |
| Product range | +++ | +++ | + | + |
| Clamping width | 200-600 mm | 250-1,500 mm | 300-600 mm | 250-600 mm |
| Throat depth | 120 mm | 140 mm | 120 mm | 140 mm |
| Optimised rail profile | ✓ | ✓ | | |
| Clamping force up to | +++ 8,500 N | +++++ 12,000 N | ++ 7,500 N | +++++ 11,000 N |
| Special pressure plate with sintered steel insert | ✓ | ✓ | | |
| Intellectual property rights | on rail, sliding arm, pressure plate and appearance | | | |

KombiKlamp

Multi-purpose clamping



The clamp that adjusts itself

The KombiKlamp is a very special clamp. Alongside the properties of a traditional all-steel screw clamp, it has a special clamping attachment. This so-called Vario clamping attachment offers a perfect fit for workpieces at angles of 60° internal to 60° external.

This makes it possible to clamp round, oval and angular workpieces both simply and securely. Spreading with the KombiKlamp is also problem free, as both the clamping attachment and the sliding arm can be quickly swapped. Now you have seen the possibilities contained within this clamp, why not try it for yourself!



Your benefits at a glance:

- 1 Multi-angle pad**
The multi-angle pad is especially adapted to round, oval and angled workpieces – from 60° inside to 60° outside. For perfectly flat clamping remove the multi-angle pad. For spreading it is easy to reverse the position of the pad on the anvil of the clamp. Its like having 3 clamps in one.
- 2 Removable end stop**
The end stop can be removed – to allow the sliding arm to be quickly turned around for spreading.
- 3 Pressure plate**
For enhanced serviceability the pressure plate can be changed with no need for tools. It can be replaced very easily and quickly.
- 4 Tommy bar with BESSEY grip**
The addition of the plastic BESSEY grip means that clamping can also be very comfortable. The stable tommy bar has a plastic pad to ensure that it is easy to grip with your hand. This allows powerful, controlled clamping.



KombiKlamp SG-VAD



| N ^o | <a> mm | mm | <x> mm | kg | qty. | V2 |
|----------------|-----------|-----------|-----------|------|------|----|
| SG30VAD | 300 | 120 | 30 x 15 | 2.95 | 6 | |



- Clamping force up to 7,500 N
- Clamping and spreading of round, oval and angled workpieces
- Pressure plates can be replaced with no need for tools

U-clamps

Step-over clamping



No spacers or extension pieces necessary

The original BESSEY U-clamps have been developed on the basis of the tried-and-tested all-steel, lever and high-performance clamps. The characteristic

U-shaped fixed arms swiftly reaches over obstructions so find its objective like an extra hand. No spacers or extensions are needed with the high stepping U-clamp.

The SGU high-performance clamp – with U-shaped fixed arm for step-over clamping with no need for spacers.



You Tube



Your benefits at a glance:

1 Extremely sturdy

The U-shaped fixed arm is produced and tempered from a single piece, thus very torsion-resistant. This guarantees you maximum tensile strength and sturdiness.

2 Special tilting pressure plate

The heat-resistant pressure plate (SGU/STBU) is replaceable and can be tilted up to 35° so it can even clamp on angled or sloping surfaces. It has an extremely long service-life due to the oil-soaked sintered steel insert's excellent sliding and emergency running properties.

3 Forged sliding arm

The sliding arm is made from forged tempered steel, and can withstand extremely large loads. You can be sure of that.

4 Tempered spindle

The tempered spindle is particularly sturdy and wear-resistant. This considerably increases its durability.

5 Sturdy tommy bar

The sturdy tommy bar has special rounded hand-friendly ends, as well as a hexagonal bolt. This allows powerful, controlled clamping.

U-clamps



- Clamping force up to 4,000 N
- Double-sided step-over clamping, specially suited for T-profiles and double T-profiles
- Low weight
- Tempered stainless steel and fixed bracket for resilient and elastic clamping



U-shaped all-steel screw clamp GUZ

| N ^o | ←a→ | ←b→ | ←c→ | ←d→ | ←x→ | ⚖ | 📦 | |
|----------------|-----|-----|-----|-----|-----------|------|------|----|
| | mm | mm | mm | mm | mm | kg | qty. | V2 |
| GU25-12-6ZK | 250 | 120 | 60 | 60 | 22 x 10.5 | 1.46 | 10 | |

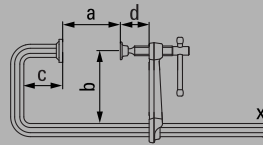

- Clamping force up to 12,000 N at tightening torque of 40 Nm
- Double-sided step-over clamping, specially suited for T-profiles and double T-profiles
- Long life due to heat-resistant pressure plate with sintered steel insert, which can be tilted up to 35°



U-shaped high-performance clamp SGU

| N ^o | ←a→ | ←b→ | ←c→ | ←d→ | ←x→ | ⚖ | 📦 | |
|----------------|-----|-----|-----|-----|---------|------|------|----|
| | mm | mm | mm | mm | mm | kg | qty. | V2 |
| SGU30-14-10 | 300 | 140 | 100 | 130 | 30 x 15 | 3.75 | 5 | |

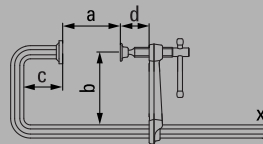

U-clamps



U-shaped high-performance clamp STBU



| N ^o | ←a→ | ←b→ | ←c→ | ←d→ | ←x→ | kg | qty. | V2 |
|----------------|-----|-----|-----|-----|---------|------|------|----|
| | mm | mm | mm | mm | mm | | | |
| STBU40-17-15 | 500 | 175 | 150 | 110 | 40 x 20 | 7.96 | 1 | |

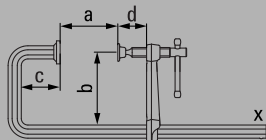

- Clamping force up to 22,000 N at tightening torque of 80 Nm
- Double-sided step-over clamping, specially suited for T-profiles and double T-profiles
- With 19 mm hexagonal bolt on the end of the spindle
- Long life due to heat-resistant pressure plate with sintered steel insert, which can be tilted up to 35°



Special pressure plate



| N ^o | Description | Suitable for | V3 |
|----------------|-------------|---|----|
| 3100736 | Standard | SLM, SGM, SGTM, STBM, STBVC, SGU, SLV, GSV, SPZ80K, TWM | |
| 3100737 | Standard | STBS, STBU | |
| 3101192 | Serrated | SLM, SGM, SGTM, STBM, STBVC, SGU, SLV, GSV, SPZ80K, TWM | |
| 3101193 | V-grooved | SLM, SGM, SGTM, STBM, STBVC, SGU, SLV, GSV, SPZ80K, TWM | |

- Long life due to heat-resistant pressure plate with sintered steel insert, which can be tilted up to 35°
- Three design versions:
 - Smooth faced (standard version)
 - Rough faced for secure clamping on dirty surfaces
 - V-groove face for round, oval and edged workpieces



U-shaped lever clamp GUH



| N ^o | ←a→ | ←b→ | ←c→ | ←d→ | ←x→ | kg | qty. | V2 |
|----------------|-----|-----|-----|-----|-----------|------|------|----|
| | mm | mm | mm | mm | mm | | | |
| GU25-12-6H | 250 | 120 | 60 | 10 | 22 x 10.5 | 1.67 | 5 | |

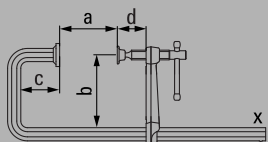

- Clamping force up to 3,800 N
- Step-over clamping, specially suited for T profiles
- Low weight
- Quick – up to 5 x faster than regular clamps



Claw clamps

Clamping and spreading in confined spaces



Ideal for particularly challenging tasks

The original BESSEY claw clamp lets you clamp and spread in even the most confined spaces. It can be used in narrow openings as well as for short projections. This is thanks to the clamp's unique

clamping and spreading mechanism, which is located behind the rail. The original BESSEY claw clamp also boasts a very robust construction. This makes it the perfect tool for particularly challenging tasks, such as welding and assembly work.

The claw clamp GRA – specially developed for welding and assembly work in poorly accessible places.



Your benefits at a glance:

- 1 Maximum stability**
The clamp forged from a single piece with moulded pressure plate is hardened, tempered and galvanised, making it highly durable and torsion-resistant. The optimised profile now allows greater extension with the same stability.
- 2 External handle**
The handle is located behind the clamp's rail. This is specially conceived to allow the clamping and spreading of work-pieces which are not easily accessible.
- 3 Special V-grooved pressure plate**
This sturdy pressure plate is made from high-grade cast iron, and can be tilted by up to 30°. The prism is ideal for clamping and spreading round or angular work-pieces.
- 4 Removable end stop**
The end stop can be removed – to allow the sliding arm to be quickly turned around for spreading.



Claw clamp GRA



| № | <a> | | <x> | ⚖ | 📦 | V2 |
|-----------|------|-----|---------|------|------|----|
| | mm | mm | mm | kg | qty. | |
| GRA30-12 | 300 | 120 | 28 x 11 | 2.41 | 5 | |
| GRA60-12 | 600 | 120 | 28 x 11 | 3.02 | 5 | |
| GRA100-12 | 1000 | 120 | 28 x 11 | 3.80 | 5 | |

Pressure piece GRD (2 pcs./bag)



| № | ⚖ | 📦 | V2 |
|-----|------|------|----|
| | kg | qty. | |
| GRD | 0.61 | 10 | |



- Clamping and spreading force up to 7,500 N
- Externally-positioned spindle, protected from welding spatter
- Clear access to work area
- Spreading from the inside outwards
- Flat jaw face
- V-groove for clamping round and oval workpieces

Variable high-performance clamps

New flexibility with large clamping widths



A modular concept for the widest range of applications

Alongside complete assembled high-performance clamping sets BESSEY also offers versatile accessories that can be combined with one another. Amongst these are two different rail models: One with a 27 x 13 mm profile in three different lengths, and another with a 30 x 15 mm profile for work with high clamping forces and clamping widths up to three metres. All rails have end fastenings on both

sides that can be loosened without tools. Sliding arms that are already fitted can be changed over from clamping to spreading or replaced by different sliding arms or even supplemented with others. Sliding arms with wooden grips, lever handles or tommy bars are available. The flexibility that this clamping system offers ensures that numerous applications can be handled by the combinations of rails and sliding arms available. There are no limits set with this individual tailoring.

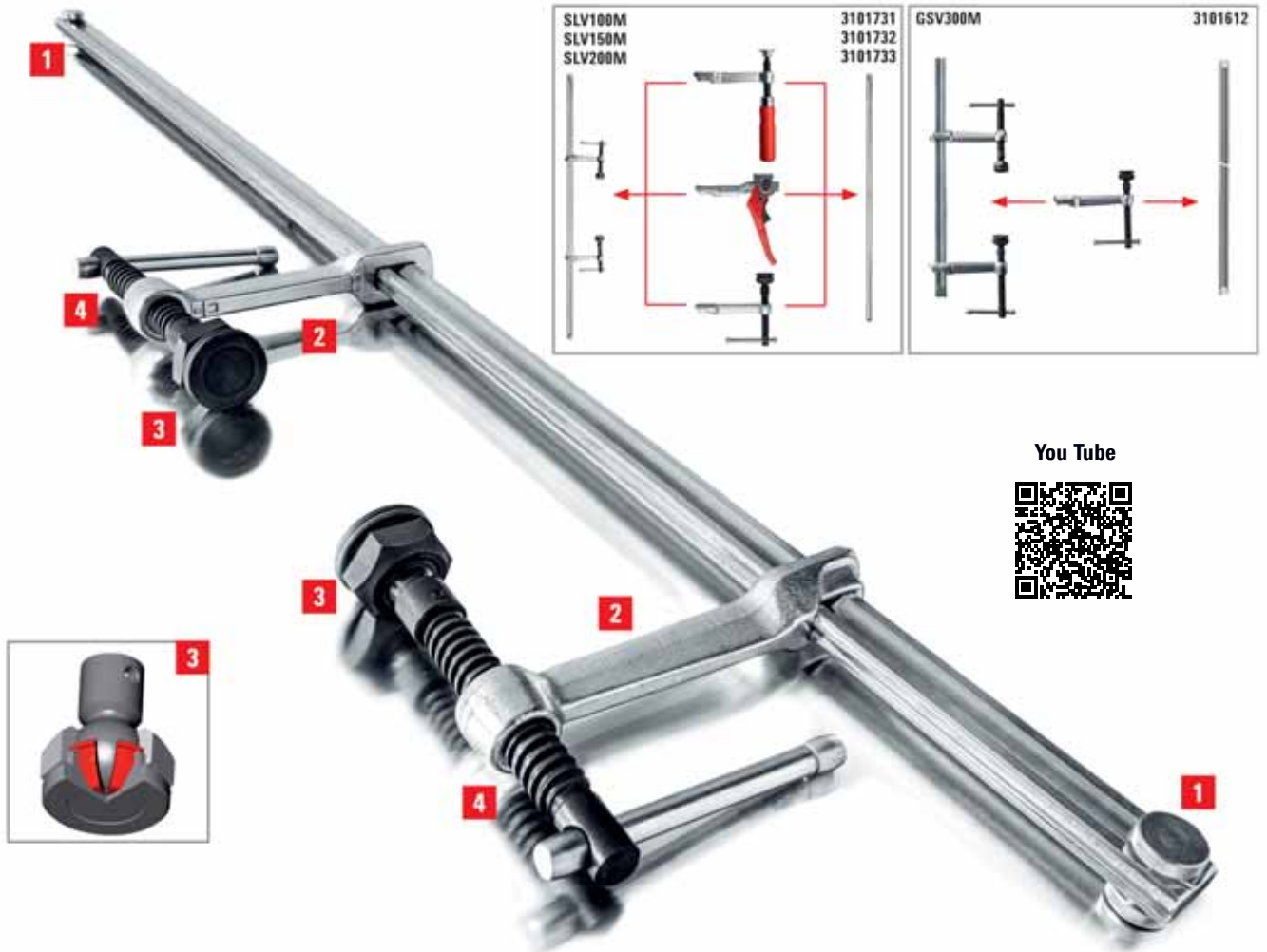

Your benefits at a glance:

1 End fastenings can be loosened without tools

The end fastenings on both sides can be loosened without tools enabling rapid changeover of the sliding arms for spreading tasks. It is also possible to replace the sliding arms or to add additional sliding arms easily.

2 Interchangeable sliding arms

The sliding arm is made from forged tempered steel and guarantees the highest level of safety through the linear transfer of forces and can withstand extremely large loads. These can be replaced by other sliding arm variants to suit the application and can also be supplemented by others.

3 Special tilting pressure plate

Both the SLV and the GSV have a special heat-resistant pressure plate. This is replaceable and can be tilted up to 35°. Furthermore, the special pressure plates used with the GSV have a hardened and oil-soaked sintered steel insert. This guarantees outstanding sliding and emergency running properties, thereby ensuring an extremely long service life.

4 Tempered spindle

The tempered spindle is particularly sturdy and wear-resistant. This considerably increases its durability.

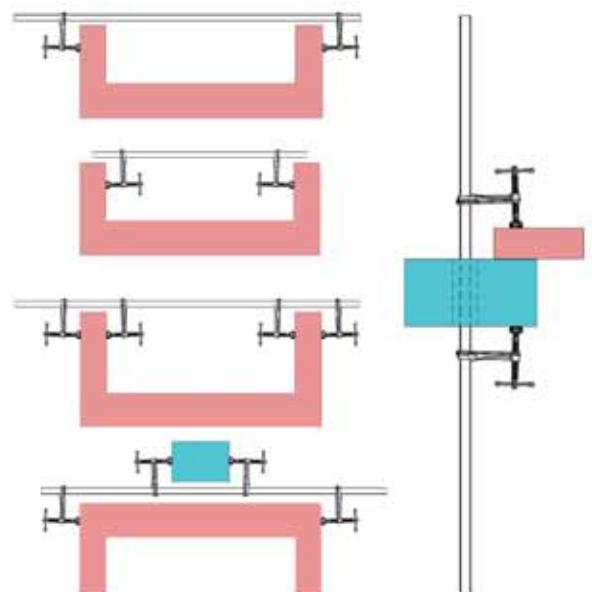

Variable high-performance clamps



- Clamping force up to 6,500 N
- Tipping is prevented through central positioning on the workpiece
- Special heat-resistant pressure plate, can be tilted by up to 35°
- Clamp can be fed through an opening in the workpiece/component



Variable high-performance clamps – Complete set SLV

| N ^o | <a> | | <e> | <x> | ⚖️ | 📦 | |
|----------------|------|-----|----------|---------|------|------|----|
| | mm | mm | mm | mm | kg | qty. | V2 |
| SLV100M | 1000 | 120 | 340-1250 | 27 x 13 | 4.71 | 1 | |
| SLV150M | 1500 | 120 | 340-1750 | 27 x 13 | 5.90 | 1 | |
| SLV200M | 2000 | 120 | 340-2250 | 27 x 13 | 6.50 | 1 | |

Wide range of possible applications due to interchangeable sliding arm available in various different designs (see accessories)

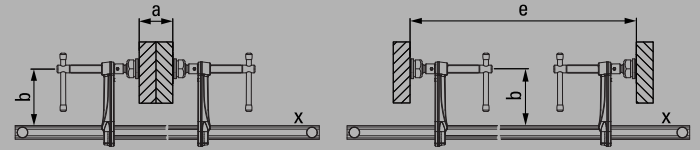

- Clamping force up to 9,000 N
- Tipping is prevented through central positioning on the workpiece
- Long service life thanks to special heat-resistant pressure plate with sintered steel insert, can be tilted by up to 35°
- Clamp can be fed through an opening in the workpiece/component

Variable high performance clamps – Complete set GSV

| N ^o | <a> | | <e> | <x> | ⚖️ | 📦 | |
|----------------|------|-----|----------|---------|-------|------|----|
| | mm | mm | mm | mm | kg | qty. | V2 |
| GSV300M | 3000 | 140 | 400-3340 | 30 x 15 | 12.98 | 1 | |

Wide range of possible applications due to interchangeable sliding arm available in various different designs (see accessories)

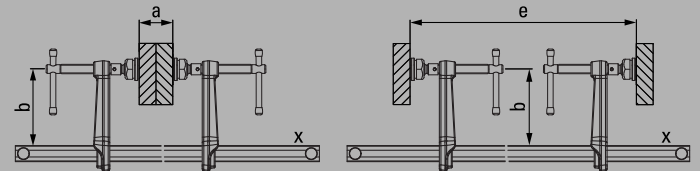

- Long life due to heat-resistant pressure plate with sintered steel insert, which can be tilted up to 35°
- Three design versions:
 - Smooth faced (standard version)
 - Rough faced for secure clamping on dirty surfaces
 - V-groove face for round, oval and edged workpieces

Special pressure plate

| N ^o | Description | Suitable for | |
|----------------|--------------|---|----|
| | | | V3 |
| 3100736 | Standard | SLM, SGM, SGTM, STBM, STBVC, SGU, SLV, GSV, SPZ80K, TWM | |
| 3101192 | Serrated | SLM, SGM, SGTM, STBM, STBVC, SGU, SLV, GSV, SPZ80K, TWM | |
| 3101193 | V-grooved | SLM, SGM, SGTM, STBM, STBVC, SGU, SLV, GSV, SPZ80K, TWM | |
| 3101219 | Cutting ring | SLV, GSV, SPZ80K | |

Anti-slip clamping with the cutting ring pressure plate
While stocks last





SLV size rails



| № | ←a→ | ←x→ | ⚖ | 📦 | V2 |
|---------|------|---------|------|------|----|
| | mm | mm | kg | qty. | |
| 3101731 | 1000 | 27 x 13 | 2.85 | 1 | |
| 3101732 | 1500 | 27 x 13 | 4.05 | 1 | |
| 3101733 | 2000 | 27 x 13 | 5.25 | 1 | |

- 27 x 13 mm profile, cold drawn and galvanised
- End fastenings on both sides can be loosened without tools – for rapid changeover
- Suitable for all SLV size sliding arms



GSV size rails



| № | ←a→ | ←x→ | ⚖ | 📦 | V2 |
|---------|------|---------|-------|------|----|
| | mm | mm | kg | qty. | |
| 3101612 | 3000 | 30 x 15 | 10.40 | 1 | |

- 30 x 15 mm profile, cold drawn and galvanised
- End fastenings on both sides can be loosened without tools – for rapid changeover
- Suitable for all GSV size sliding arms



Complete sliding arm for SLV sizes



| № | Description | ←b→ | ←x→ | ⚖ | 📦 | V3 |
|---------|--|-----|---------|------|------|----|
| | | mm | mm | kg | qty. | |
| 3101426 | Wooden handle | 120 | 27 x 13 | 0.73 | 1 | |
| 3101337 | Lever handle | 120 | 27 x 13 | 1.10 | 1 | |
| 3101338 | Tommy bar incl. special pressure plate | 120 | 27 x 13 | 0.82 | 1 | |

- Three different grip variants/designs
- Suitable for all SLV size rails



Complete sliding arm for GSV sizes



| № | Description | ←b→ | ←x→ | ⚖ | 📦 | V3 |
|---------|---|-----|---------|------|------|----|
| | | mm | mm | kg | qty. | |
| 3101329 | Tommy bar incl. special pressure plate with sintered steel insert | 120 | 30 x 15 | 1.13 | 1 | |
| 3101330 | | 140 | 30 x 15 | 1.23 | 1 | |
| 3101331 | | 200 | 30 x 15 | 1.40 | 1 | |

- One arm design with three throat depths
- Suitable for GSV size rails

C-clamps

Clamping using the original screw clamp shape



Whether manufactured using drop forging or drawn steel the BESSEY C-clamps provide a solution for every application

C-clamps are used when high clamping forces are required with consistently equal jaw openings, predominantly in the metal and steel-working sector. The C-clamp is the original type of screw clamp. A wide range of materials have been and are used in their manufacture. At one time there were

even versions made purely out of BESSEY all steel, whether drawn or forged, C-clamps now provide solutions for all the demands of the modern market. The VC Series is noteworthy for the fact that its frame is produced with original BESSEY profiled steel from our in-house steel drawing plant. It is then tempered and electro-galvanised. This achieves much higher tensile strength compared to cast versions.

The C-screw clamp VC is unique in featuring the characteristics of the original BESSEY all-steel screw clamp – it is light, handy, elastic and break-resistant.

C-clamps



C-clamp VC



| N ^o | <a> | | | | <x> | | | | V2 |
|----------------|---------|-----------|-----|-------|------------|----|------|----|----|
| | mm | " | mm | " | | | | | |
| VC2 | 0-50 | 0 - 2 | 50 | 2 | 19.5 x 9.5 | 7 | 0.43 | 10 | |
| VC3 | 0 - 75 | 0 - 3 | 50 | 2 | 22 x 10.5 | 13 | 0.63 | 10 | |
| VC4 | 0 - 100 | 0 - 4 | 60 | 2 3/8 | 25 x 12 | 13 | 1.02 | 10 | |
| VC6 | 0 - 150 | 0 - 6 | 75 | 3 | 27 x 13 | 15 | 1.41 | 10 | |
| VC8 | 0 - 200 | 0 - 7 7/8 | 90 | 3 1/2 | 30 x 15 | 15 | 2.25 | 5 | |
| VC10 | 0 - 250 | 0 - 10 | 100 | 4 | 40 x 20 | 15 | 4.01 | 5 | |



- Clamping force of up to 15,000 N
- Nearly unbreakable and tempered
- Tried-and-true BESSEY all-steel quality



C-clamp SC



| N ^o | <a> | | | | | | | V2 |
|----------------|---------|-----------|-----|--------|------|------|----|----|
| | mm | " | mm | " | | | | |
| SC40 | 0-40 | 0 - 1 5/8 | 40 | 1 5/8 | 5,5 | 0.36 | 10 | |
| SC60 | 0 - 60 | 0 - 2 3/8 | 55 | 2 3/16 | 5,5 | 0.57 | 10 | |
| SC80 | 0 - 80 | 0 - 3 1/8 | 65 | 2 9/16 | 10 | 0.99 | 10 | |
| SC100 | 0 - 100 | 0 - 4 | 75 | 3 | 13,5 | 1.40 | 10 | |
| SC120 | 0 - 120 | 0 - 7 7/8 | 85 | 3 1/4 | 18 | 2.10 | 10 | |
| SC150 | 0 - 150 | 0 - 6 | 95 | 3 3/4 | 18 | 2.35 | 10 | |
| SC200 | 0 - 200 | 0 - 7 7/8 | 105 | 4 1/4 | 22 | 4.00 | 5 | |



- Clamping force up to 22,000 N
- Drop forged



C-clamp CDF-C



| N ^o | <a> | | | | | | | V2 |
|----------------|---------|-----------|-----|-------|------|------|---|----|
| | mm | " | mm | " | | | | |
| CDF403C | 0 - 75 | 0 - 3 | 60 | 2 3/8 | 13 | 0.85 | 6 | |
| CDF404C | 0 - 105 | 0 - 4 1/4 | 85 | 2 3/4 | 16,5 | 1.50 | 6 | |
| CDF406C | 0 - 150 | 0 - 6 | 100 | 3 5/8 | 17 | 2.32 | 6 | |
| CDF408C | 0 - 205 | 0 - 8 | 125 | 4 1/2 | 17 | 3.42 | 6 | |
| CDF410C | 50-245 | 2 - 10 | 150 | 5 3/8 | 18 | 5.30 | 4 | |



- Clamping force up to 18,000 N
- Drop forged
- The copper-plated spindle prevents welding splatter from sticking

Grip pliers

Clamping and gripping



Many variants to cover a very wide range of applications

Whether for all-round or step-over clamping, or for fixing workpieces which are lying next to one another: the original BESSEY grip pliers are always ideal. This is because the infinitely adjustable plier

jaws lie parallel to each other in every position, or at the desired angle to one another. And the best thing is: the selected clamping pressure remains constant however wide open the mouth of the pliers is. That's true whatever variant you choose. Try it out!

The pipe grip GRZRO – secure clamping of round workpieces thanks to infinitely adjustable plier jaws.

You Tube



Grip pliers



Parallel grip GRZ



| N ^o | <a> | | | | |
|----------------|-----|-----|------|------|----|
| | mm | mm | kg | qty. | V3 |
| GRZ10 | 100 | 65 | 1.00 | 10 | |
| GRZ20 | 200 | 65 | 1.20 | 10 | |



- Parallel jaw faces
- Prism recess for small round parts
- Includes pressure caps for gentle clamping of sensitive surfaces



C-grip GRZC



| N ^o | <a> | | <d> | | | |
|----------------|-----|-----|-----|------|------|----|
| | mm | mm | mm | kg | qty. | V3 |
| GRZC | 110 | 80 | 40 | 1.10 | 10 | |

- For step-over clamping from both sides



Variogrip GRZV



| N ^o | <a> | | <d> | | | |
|----------------|-----|-------|-----|------|------|----|
| | mm | mm | mm | kg | qty. | V3 |
| GRZV | 100 | 50-80 | 43 | 1.25 | 10 | |

While stocks last

- Throat depth and opening are infinitely adjustable thanks to split sliding arm
- For clamping workpieces of different thicknesses, or non-aligned workpieces



Pipe grip GRZRO



| N ^o | For pipes Ø | | | | |
|----------------|-------------|-----|------|------|----|
| | mm | mm | kg | qty. | V3 |
| GRZRO | 0 – 110 | 65 | 1.30 | 10 | |

- Ideal for holding round objects of constant diameter
- Includes pressure caps
- Gentle clamping of sensitive surfaces
- Suitable for tack welding, heat-resistant up to 200° C

Earth (ground) clamps

- With malleable cast iron arms
- Ergonomically shaped wood handle
- Grounding connection hole in the upper part



Earth (ground) clamp LP / TP with tried-and-true wooden handle

| N ^o | ←a→ | ←b→ | ←x→ | | | | | V1 |
|----------------|-----|-----|--------|------|-----|------|------|----|
| | mm | mm | mm | mm | A | kg | qty. | |
| LP-1 | 150 | 60 | 20 x 5 | 10,5 | 300 | 0.50 | 10 | |
| TP-1 | 150 | 80 | 25 x 6 | 10,5 | 400 | 0.76 | 10 | |

- With malleable cast iron arms
- Practical thumb screw
- Grounding connection hole in the upper part
- TP-...F-RK: Cable strain relief at rail end / ring internal diameter 30 mm



Earth (ground) clamp LP / TP with thumb screw

| N ^o | ←a→ | ←b→ | ←x→ | | | | | V1 |
|----------------|-----|-----|--------|------|-----|------|------|----|
| | mm | mm | mm | mm | A | kg | qty. | |
| LP-1F | 150 | 60 | 20 x 5 | 10,5 | 300 | 0.53 | 10 | |
| TP-1F | 150 | 80 | 25 x 6 | 10,5 | 400 | 0.76 | 10 | |
| TP-2F | 150 | 60 | 30 x 8 | 11 | 600 | 1.12 | 20 | |
| TP-1F-RK | 150 | 80 | 25 x 6 | 10,5 | 400 | 0.78 | 10 | |
| TP-2F-RK | 150 | 60 | 30 x 8 | 11 | 600 | 1.12 | 20 | |

- With malleable cast iron arms
- Tommy bar with rounded ends for simple transfer of force when clamping
- Grounding connection hole in the upper part



Earth (ground) clamp TP with tommy bar

| N ^o | ←a→ | ←b→ | ←x→ | | | | | V1 |
|----------------|-----|-----|--------|------|-----|------|------|----|
| | mm | mm | mm | mm | A | kg | qty. | |
| TP-1K | 150 | 80 | 25 x 6 | 10,5 | 400 | 0.75 | 10 | |

- With C-shaped malleable cast iron arms



Earth (ground) clamp CP

| N ^o | ←a→ | ←b→ | | | | | V1 |
|----------------|-----|-----|-----|-----|------|------|----|
| | mm | mm | mm | A | kg | qty. | |
| CP-F | 50 | 30 | 8,4 | 200 | 0.19 | 10 | |

Clamping devices



Multi angle pad VAD (2 pcs./bag)



| N ^o | | Jaw face width | | | |
|----------------|-----------------------------|----------------|------|------|----|
| | | mm | kg | qty. | V3 |
| VAD | from 60° inner to 60° outer | 45 | 0.48 | 1 | |



- For adaptation to round, oval and angular workpieces in particular
- Infinite angle adjustment from 60° inner to 60° outer
- Suitable for original BESSEY malleable cast iron screw clamps TG as well as GZ and GMZ from 100 mm throat depth and for clamping elements for welding tables TWV and TW



Edge clamp KT



| N ^o | Description | | | |
|----------------|-------------|------|------|----|
| | | kg | qty. | V1 |
| KT5-1CP | 1 spindle | 0.35 | 1 | |
| KT5-2 | 2 spindles | 0.58 | 1 | |



- Practical accessory for clamping edges and difficult to reach areas
- Suitable for conventional screw clamps with a max. rail thickness of 13 mm

Metal angle clamps

Clamping angles and mitres



Unhindered access to workpiece during welding and assembly work

The original BESSEY metal angle clamps have been especially developed for use in steel construction, welding and metalworking. Their wide range of applications includes e.g. holding, fixing and

aligning materials at an exact right angle. The clear working area means that you can access the workpiece unhindered during welding and assembly work, and when fixing T-joints. That's why the original BESSEY metal angle clamp is a must for every workshop.

The metal angle clamp WSM – for holding workpieces – including workpieces of different thicknesses – at a precise 90° angle.

Your benefits at a glance:

1 Automatic adjustment

The spindle nut with articulated bearing allows automatic adjustment of the pressure jaws for different workpiece resistances.

2 Open working area

The open passage makes it possible to fix T-fasteners and ensures free access to the workpiece for welding and assembly work.

3 Stable base and clamping jaws

The stable base and the clamping jaws are manufactured from high-quality cast iron for high clamping power. They are zinc-coated and thus protected against corrosion. The jaws are processed for precise right-angled clamping.

4 Copper-plated spindle

The spindle with acme thread is copper-plated to prevent the adhesion of welding spatter.

You Tube

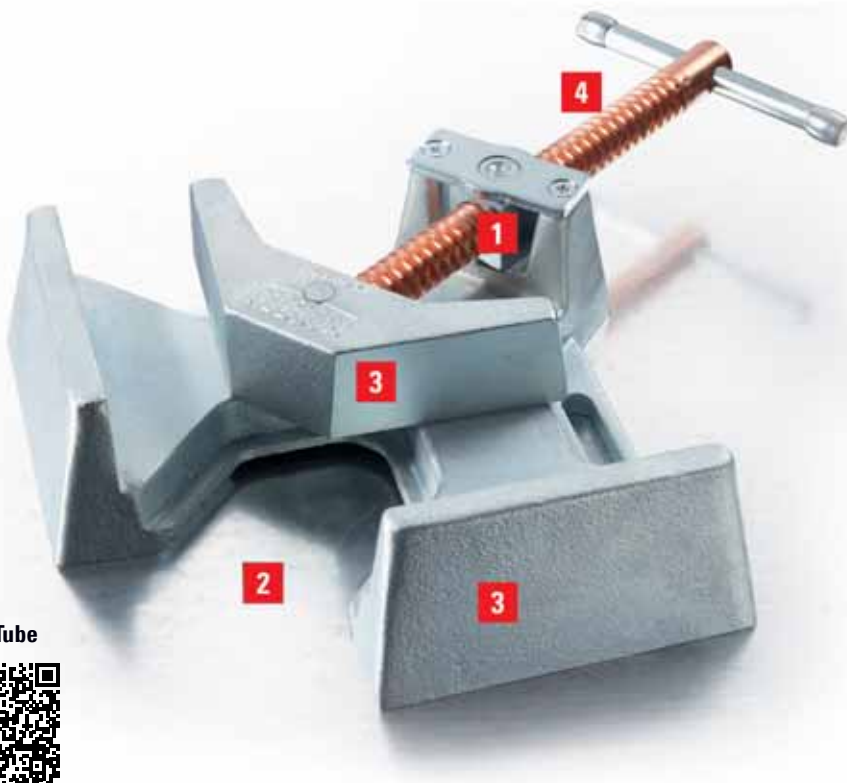

Welders' angle clamps WSM



| No | ←a→ mm | Current passage m mm | mm | kg | qty. | V3 |
|-------|-----------|----------------------------|--------|--------|----------|----|
| WSM9 | 2 x 90 | 60 | 35 | 3.58 | 1 | |
| WSM12 | 2 x 120 | 100 | 61 | 7.35 | 1 | |

3D CAD data for download at www.bessey.de

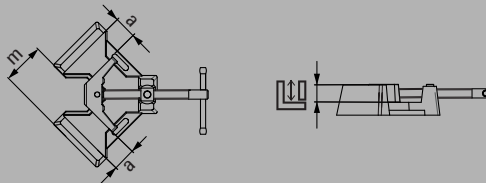

Welding clamp set SM 10



| No | ° | ←a→ mm | mm | kg | qty. | V3 |
|----------|---------|-----------|--------|--------|----------|----|
| SM10-SET | 5°-180° | 100 | 35 | 10.66 | 1 | |

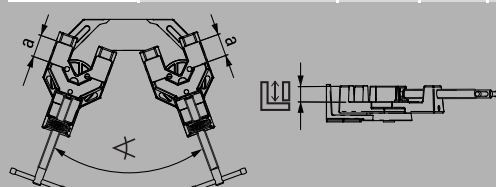

- Automatic adjustment to workpieces of various thicknesses
- Sturdy jaws and base plate made from high-quality cast iron
- The copper-plated spindle prevents welding splatter from sticking
- Precise 90°-angles

- Clamping aid for clamping components of different thicknesses at any chosen angle
- Sturdy body and base plate made from high-quality cast iron
- The copper-plated spindle prevents welding splatter from sticking
- Angle range: 5°-180°

Clamping elements for welding tables

Clamping specialists promote safe welding



Bringing our experience to the table

BESSEY has now transferred its experience of clamping tools amassed over the course of many decades into the development of its new clamping elements for welding tables with 28 mm and 16 mm fastening holes. It offers a comprehensive range of practical aids, with varied uses, to facilitate your day-to-day work. With the standard clamping elements, you can choose from 3 handle designs, as well as versions with either variable or fixed throat depth. The range also contains a clamping element

with a heat-resistant special pressure plate and a gripping arm variant to enable easy access to the work area. In order to clamp oval-shaped, round and square workpieces, special table clamping attachments are available. **BESSEY** toggle clamps and work table clamps can also be used on welding tables thanks to special adapters, extensions and attachments. All elements can be integrated into the table without using tools, which makes them highly adaptable and enables comfortable, safe and precise operation. Try them out for yourself!



Your benefits at a glance:

1 Flexible throat depth

BESSEY TWV clamping elements for welding tables not only have infinitely adjustable throat depth, but are also available in 3 handle variants.

2 100, 120 mm or 140 mm throat depth

On BESSEY TW clamping elements, you can choose among 3 handle variants and 3 throat-depth variants.

3 Heavy-duty, custom design

The TWM28 clamping element has a heat-resistant special pressure plate with sintered steel insert, which can be pivoted up to 35°. On the TW28GRS gripping arm variant the spindle is located on the outside, which enables – among other things – free access to the work area.

4 Perfect for railings

Whether the workpiece is round, oval or square, the TWWAD Vario table clamping attachments are ideally suited; this is because they can be infinitely adjusted to the workpiece being welded, from 60° internal to 60° external.

5 Applying the quick clamp

Thanks to the TWA-STC adapter and the appropriate TWX extension, BESSEY toggle clamps with a horizontal base plate can also be rapidly applied to welding tables.

6 Diagonal and horizontal clamping

The tilting adaptor TW28AV used in conjunction with the extension TW28X allows angled or horizontal clamping in a range from -52deg. to +52deg.

7 Existing work table clamps

Are you already using BESSEY work table clamps and want to also use them on your welding table? This is made possible by simply screwing the TW28HO attachment into the hole on the bottom of the work table clamp.

YouTube



Clamping elements for welding tables



Clamping element with variable throat depth TWV



| N ^o | ∅ | Clamping height | | <x> | ⚖ | 📦 | |
|----------------|----|-----------------|---------|----------|------|------|----|
| | mm | mm | mm | mm | kg | qty. | V3 |
| TWV16-20-15-2K | 16 | 200 | 30-150 | 22 x 8.5 | 1.12 | 1 | |
| TWV16-20-15K | 16 | 200 | 30-150 | 22 x 8.5 | 1.04 | 1 | |
| TWV16-20-15H | 16 | 200 | 60-150 | 22 x 8.5 | 1.21 | 1 | |
| TWV28-30-17-2K | 28 | 300 | 40-175 | 28 x 11 | 2.22 | 1 | |
| TWV28-30-17K | 28 | 300 | 40-175 | 28 x 11 | 2.11 | 1 | |
| TWV28-30-17H | 28 | 300 | 110-175 | 28 x 11 | 2.48 | 1 | |

3D CAD data for download at www.bessey.de

- TWV16: Clamping force up to 2,500 N, TWV28: Clamping force up to 5,500 N
- Precise, individual clamping
- Tempered profile and sliding arm for sprung and elastic clamping
- Infinitely adjustable throat depth
- Various design versions:
- High quality 2-component plastic handle and tommy bar with rounded ends – each with smooth-running trapezoidal threaded spindle and tool-free pressure plate replacement
- Lever handle with an indexing mechanism for controlled, fast and vibration-proof clamping

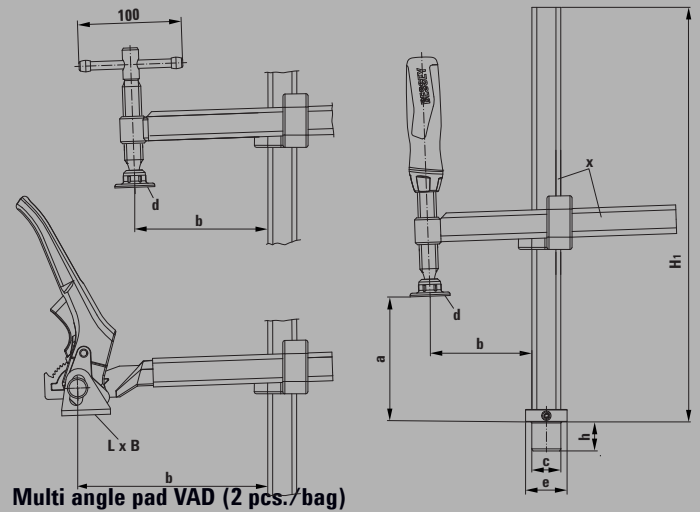

Multi angle pad VAD (2 pcs./bag)



| N ^o | ∠ | Jaw face width | ⚖ | 📦 | |
|----------------|-----------------------------|----------------|------|------|----|
| | | mm | kg | qty. | V3 |
| VAD | from 60° inner to 60° outer | 45 | 0.48 | 1 | |

see catalogue page 57

Table of dimensions

| | Bolt ∅ | Bolt height | Clamping height | Throat depth | Height of base | Pressure plate dimensions | | Foot "F" | | Rail profile |
|----------------|--------|-------------|-----------------|--------------|----------------|---------------------------|-------|------------|-------------|--------------|
| | "c" | "h" | "a" | "b" | "H1" | "L x B" | ∅ "d" | Foot ∅ "e" | Foot height | mm |
| | mm | mm | mm | mm | mm | mm | mm | mm | mm | mm |
| TWV16-20-15-2K | 16 | 20.5 | 200 | 30-150 | 265 | – | 32 | 30 | 10 | 22 x 8.5 |
| TWV16-20-15K | 16 | 20.5 | 200 | 30-150 | 265 | – | 32 | 30 | 10 | 22 x 8.5 |
| TWV16-20-15H | 16 | 20.5 | 200 | 60-150 | 265 | 41 x 26 | – | 30 | 10 | 22 x 8.5 |
| TWV28-30-17-2K | 28 | 28.5 | 300 | 40-175 | 400 | – | 38 | 40 | 12 | 28 x 11 |
| TWV28-30-17K | 28 | 28.5 | 300 | 40-175 | 400 | – | 38 | 40 | 12 | 28 x 11 |
| TWV28-30-17H | 28 | 28.5 | 300 | 110-175 | 400 | 47 x 31 | – | 40 | 12 | 28 x 11 |

Clamping elements for welding tables



Clamping element with fixed throat depth TW



| № | Ø | Clamping height | | <x> | kg | qty. | V3 |
|---------------|----|-----------------|-----|----------|------|------|----|
| | | | | | | | |
| TW16-20-10-2K | 16 | 200 | 100 | 22 x 8.5 | 0.93 | 1 | |
| TW16-20-10K | 16 | 200 | 100 | 22 x 8.5 | 0.86 | 1 | |
| TW16-20-10H | 16 | 200 | 100 | 22 x 8.5 | 1.01 | 1 | |
| TW28-30-12-2K | 28 | 300 | 120 | 28 x 11 | 1.68 | 1 | |
| TW28-30-14-2K | 28 | 300 | 140 | 28 x 11 | 1.70 | 1 | |
| TW28-30-12K | 28 | 300 | 120 | 28 x 11 | 1.62 | 1 | |
| TW28-30-14K | 28 | 300 | 140 | 28 x 11 | 1.65 | 1 | |
| TW28-30-12H | 28 | 300 | 120 | 28 x 11 | 2.07 | 1 | |
| TW28-30-14H | 28 | 300 | 140 | 28 x 11 | 2.08 | 1 | |

3D CAD data for download at www.bessey.de

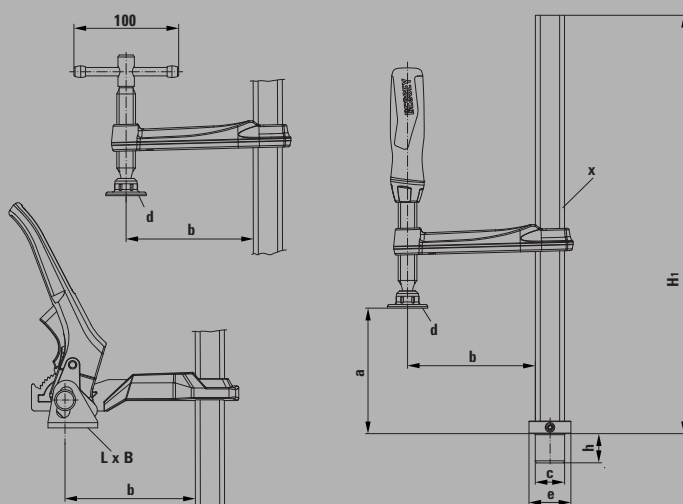

- TW16: Clamping force up to 3,000 N, TW28: Clamping force up to 5,000 N
- Precise, individual clamping
- Tempered profile and sliding arm for sprung and elastic clamping
- Various design versions:
- High quality 2-component plastic handle and tommy bar with rounded ends – each with smooth-running trapezoidal threaded spindle and tool-free pressure plate replacement
- Lever handle with an indexing mechanism for controlled, fast and vibration-proof clamping

Table of dimensions

| | Bolt Ø | Bolt height | Clamping height | Throat depth | Height of base | Pressure plate dimensions | | Foot "F" | | Rail profile |
|---------------|--------|-------------|-----------------|--------------|----------------|---------------------------|-------|------------|-------------|--------------|
| | "c" | "h" | "a" | "b" | "H1" | "L x B" | Ø "d" | Foot Ø "e" | Foot height | |
| | mm | mm | mm | mm | mm | mm | mm | mm | mm | mm |
| TW16-20-10-2K | 16 | 20.5 | 200 | 100 | 265 | – | 32 | 30 | 10 | 22 x 8.5 |
| TW16-20-10K | 16 | 20.5 | 200 | 100 | 265 | – | 32 | 30 | 10 | 22 x 8.5 |
| TW16-20-10H | 16 | 20.5 | 200 | 100 | 265 | 41 x 26 | – | 30 | 10 | 22 x 8.5 |
| TW28-30-12-2K | 28 | 28.5 | 300 | 120 | 400 | – | 38 | 40 | 12 | 28 x 11 |
| TW28-30-14-2K | 28 | 28.5 | 300 | 140 | 400 | – | 38 | 40 | 12 | 28 x 11 |
| TW28-30-12K | 28 | 28.5 | 300 | 120 | 400 | – | 38 | 40 | 12 | 28 x 11 |
| TW28-30-14K | 28 | 28.5 | 300 | 140 | 400 | – | 38 | 40 | 12 | 28 x 11 |
| TW28-30-12H | 28 | 28.5 | 300 | 120 | 400 | 47 x 31 | – | 40 | 12 | 28 x 11 |
| TW28-30-14H | 28 | 28.5 | 300 | 140 | 400 | 47 x 31 | – | 40 | 12 | 28 x 11 |

Clamping elements for welding tables



- Clamping force up to 6,500 N
- Precise, individual clamping
- Tempered profile and sliding arm for sprung and elastic clamping
- Tempered spindle – particularly sturdy and wear-resistant – for noticeably improved service life
- Long life due to heat-resistant pressure plate with sintered steel insert, which can be tilted up to 35°



Clamping element with special pressure plate TWM28

| N ^o | Ø | Clamping height | ←b→ | ←x→ | ⚖ | 📦 | |
|----------------|----|-----------------|-----|---------|------|------|----|
| | mm | mm | mm | mm | kg | qty. | V3 |
| TWM28-30-12 | 28 | 300 | 120 | 28 x 11 | 1.78 | 1 | |

3D CAD data for download at www.bessey.de

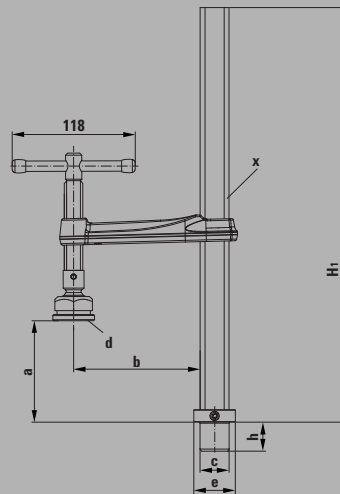

- Long life due to heat-resistant pressure plate with sintered steel insert, which can be tilted up to 35°
- Three design versions:
 - Smooth faced (standard version)
 - Rough faced for secure clamping on dirty surfaces
 - V-groove face for round, oval and edged workpieces



Special pressure plate

| N ^o | Description | |
|----------------|-------------|----|
| | | V3 |
| 3100736 | Standard | |
| 3101192 | Serrated | |
| 3101193 | V-grooved | |

Table of dimensions

| | Bolt Ø | Bolt height | Clamping height | Throat depth | Height of base | Pressure plate dimensions | | Foot "F" | | Rail profile |
|-------------|--------|-------------|-----------------|--------------|----------------|---------------------------|-------|------------|-------------|--------------|
| | "c" | "h" | "a" | "b" | "H1" | "L x B" | Ø "d" | Foot Ø "e" | Foot height | mm |
| TWM28-30-12 | mm | mm | mm | mm | mm | mm | mm | mm | mm | mm |
| | 28 | 28.5 | 300 | 120 | 400 | - | 40 | 40 | 12 | 28 x 11 |

Clamping elements for welding tables



Clamping element with gripping arm TW28GRS



| N ^o | ∅ | Clamping height | ←b→ | ←x→ | ⚖ | 📦 | |
|----------------|----|-----------------|-----|---------|------|------|----|
| | mm | mm | mm | mm | kg | qty. | V3 |
| TW28GRS30-12 | 28 | 300 | 120 | 28 x 11 | 2.26 | 1 | |

3D CAD data for download at www.bessey.de

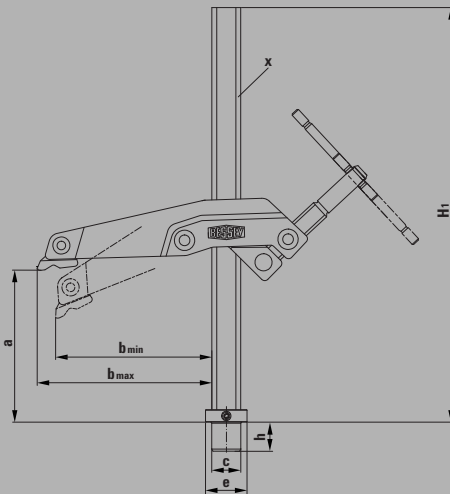

- Clamping force up to 5,000 N
- The spindle is located on the outside for free access to the work area and to protect against welding spatter
- Special, sturdy V-grooved pressure plate, ideal even for clamping round or square workpieces
- Pivotal and infinitely adjustable in terms of height
- Particularly suited to clamping with the tightest of space constraints, in narrow openings as well as for short projections



Vario table clamping attachment TWVAD (2 pcs./bag)



| N ^o | ∅ | ∠ | Jaw face width | ⚖ | 📦 | |
|----------------|----|-----------------------------|----------------|------|------|----|
| | mm | | mm | kg | qty. | V3 |
| TW16VAD | 16 | from 60° inner to 60° outer | 45 | 0.38 | 1 | |
| TW28VAD | 28 | | 45 | 0.57 | 1 | |
| TWVAD | - | | 45 | 0.28 | 1 | |

3D CAD data for download at www.bessey.de



- Specifically adapted to round, oval and square workpieces
- Angle infinitely adjustable from 60° internal to 60° external
- Various design versions:
 - TW16VAD/TW28VAD – version with bolt – for rapidly aligning and fixing the workpiece to the welding table
 - TWVAD – version without bolt – for variable movement on the welding table

Table of dimensions

| | Bolt ∅ | Bolt height | Clamping height | Throat depth | Height of base | Pressure plate dimensions | Foot "F" | | Rail profile |
|--------------|--------|-------------|-----------------|--------------|----------------|---------------------------|------------|-------------|--------------|
| | "c" | "h" | "a" | "b" | "H1" | "L x B" | Foot ∅ "e" | Foot height | |
| | mm | mm | mm | mm | mm | mm | mm | mm | mm |
| TW28GRS30-12 | 28 | 28.5 | 300 | 123-140 | 400 | 38 x 25 | 40 | 12 | 28 x 11 |



Clamping elements for welding tables



- Accessory for BESSEY STC toggle clamp with horizontal base plate
- With bolt – for use directly on the welding table
- Without bolt – for screwing to the extension TWX



Toggle clamp adapter TWA-STC

| N ^o | ∅ | Suitable for |  |  |  | |
|----------------|----|------------------|---|---|---|----|
| | mm | | mm | kg | qty. | V3 |
| TW16A-STC | 16 | STC-VH STC-HH | M5 | 0.19 | 1 | |
| TW28A-STC | 28 | STC-IHH | M6 | 0.28 | 1 | |



3D CAD data for download at www.bessey.de



- Accessory for BESSEY toggle clamp adapter TWA-STC, TWVAD and TW28AV
- Lowering of round workpieces is infinitely adjustable using the adjusting ring in the table



Extension TWX

| N ^o | ∅ | Suitable for | Adjusting range |  |  | |
|----------------|----|---|-----------------|---|---|----|
| | mm | | mm | kg | qty. | V3 |
| TW16X | 16 | TW16A-STC TW16VAD TWVAD | 15-200 | 0.41 | 1 | |
| TW28X | 28 | TW28A-STC TW28VAD TWVAD TW28AV | 15-300 | 1.76 | 1 | |

3D CAD data for download at www.bessey.de

Clamping elements for welding tables



Tilting adapter TW28AV



| N ^o | ∅ | <a> | Suitable for | ⚖ | 📦 | |
|----------------|----|-----|--------------|------|------|----|
| | mm | mm | | kg | qty. | V3 |
| TW28AV | 28 | 160 | TW28X | 0.90 | 1 | |

3D CAD data for download at www.bessey.de

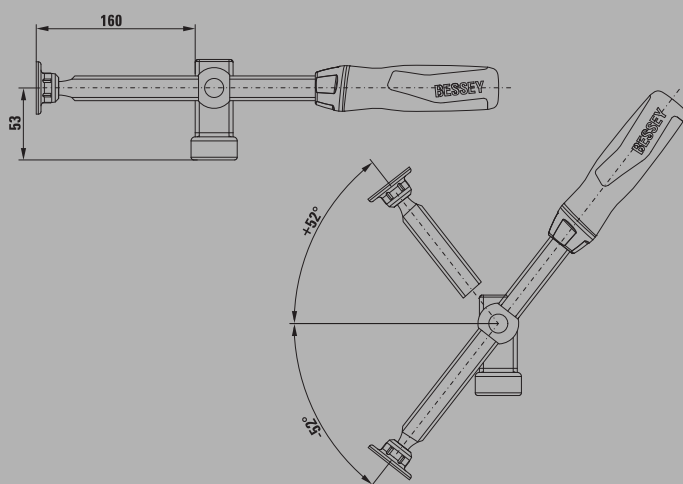

- Clamping force up to 3,000 N
- Accessory for BESSEY extension TW28X
- Pivoting spindles with stepless adjustment from -52° to +52°
- Lockable trapezoidal nut for secure fastening of the workpiece
- High quality, 2-component plastic grip with long spindle



Attachment TW28HO



| N ^o | ∅ | Suitable for | ⚖ | 📦 | |
|----------------|----|---|------|------|----|
| | mm | | kg | qty. | V3 |
| TW28HO | 28 | BAS-C / BAS-CB / BASO / BSN / GRS / BSG | 0.14 | 1 | |

3D CAD data for download at www.bessey.de
While stocks last



- Accessory for BESSEY work table clamp
- It can be used on welding tables by simply screwing it to the work table clamp

Machine table clamps

Clamping to equipment and machine tables



Rapid, powerful and safe when clamping to equipment and machine tables

At BESSEY you will also find a range of practical work table clamps – ideal clamps for assembly, drilling, rubbing, milling, grinding, honing, eroding, testing and much more. Original BESSEY BAS clamps are characterised above all by their incredibly compact design and high clamping pressure. The housings and clamping arms are made from tempered stainless steel and are therefore extremely heavy duty – even after many years of use and in the most restricted spaces. The work table clamps BS and the claw machine

clamp GRS can be tilted and are infinitely adjustable. The BS identifies a lever mechanism that facilitates quick clamping and releasing. When unobstructed access to the work area is a requirement or when clamping has to be done in confined spaces, the claw machine clamp GRS provides the necessary function thanks to an externally-positioned spindle. And, thanks to its swivelling pressure plate, the BSG work table clamp also provides the answer when clamping sloping parts, up to 35 degrees. As you can see, a comprehensive product range of products that leaves virtually no desire unanswered!



Your benefits at a glance:

1 Housings and clamping arms made from tempered stainless steel

BAS clamps are approx. 30 % smaller than comparable tools made by competitors and still provide the same high clamping forces. At a perpendicular to the jaw face, the self-locking worm gear unit exerts up to 16,000 N.

2 Clamping arm variants with polyamide seal

To provide for gentle clamping with optimum weight distribution, the short and long clamping arms of the BAS models are equipped with a swivelling aluminium pressure shoe. And when clamping has to be done in corners, BSP models equipped with a pointed clamping arm are the perfect tools. A special polyamide seal protects the interior against dirt

3 Open or closed fastening holes

Models with an open hole can be clamped and unclamped more quickly. In closed versions, the screw, nut and clamp form a unit.

4 Space saving and adjustable

The compact design, both in height and surface requirements, distinguishes all of the models. Clamping height can be increased progressively in 80 mm steps with the BESSEY BAS0 base unit. When using more than one base unit, care must be taken to provide precise workpiece contact surfaces.



Machine table clamps



BAS-C9-4

BAS-C10-6

BSP-C10-6

BAS-C compact clamp, fixing hole open

| No | <a> | | ⚖ | 📦 | V3 |
|-----------|-----|-----|------|------|----|
| | mm | mm | kg | qty. | |
| BAS-C9-4 | 88 | 40 | 1.30 | 1 | |
| BAS-C10-6 | 97 | 60 | 1.30 | 1 | |
| BSP-C10-6 | 97 | 60 | 1.30 | 1 | |



BAS-CB9-4

BAS-CB10-6

BSP-CB10-6

BAS-CB compact clamp, fixing hole closed

| No | <a> | | ⚖ | 📦 | V3 |
|------------|-----|-----|------|------|----|
| | mm | mm | kg | qty. | |
| BAS-CB9-4 | 88 | 40 | 1.30 | 1 | |
| BAS-CB10-6 | 97 | 60 | 1.30 | 1 | |
| BSP-CB10-6 | 97 | 60 | 1.30 | 1 | |

- Clamping force up to 16,000 N
- Space-saving construction, thus up to 30% smaller than comparable competitive models
- Housing and pressure arm made from hardened and tempered stainless steel, making it extremely robust and durable
- Available in three pressure arm versions: Short and long pressure arm with swivelable aluminium pressure shoe or pointed pressure arm for clamping on narrow sections or in confined spaces
- BAS-C with open fixing hole and BAS-CB with closed fixing hole for M10/M12

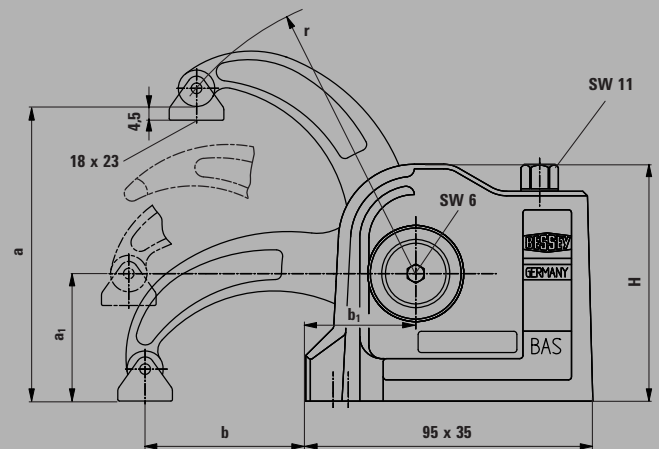

3D CAD data for download at www.bessey.de

Machine table clamps



Base unit BASO





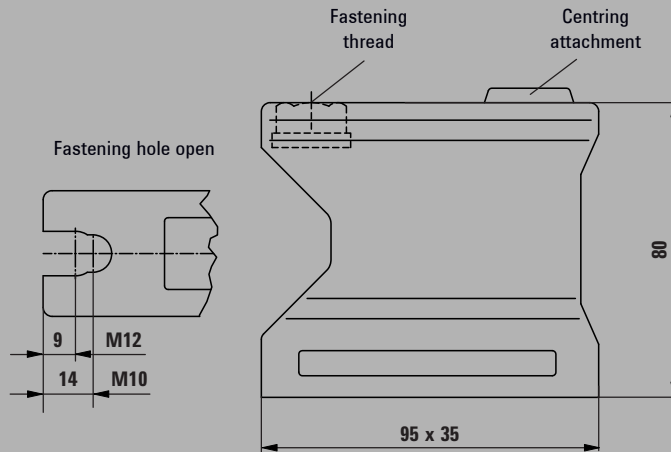





| № | Clamping height | Fastening thread | For socket head screw DIN 912 | kg | qty. | V3 |
|------|-----------------|------------------|-------------------------------|------|------|----|
| | mm | | | | | |
| BASO | 80 | M 10 | M10 / M12 | 0.45 | 1 | |



- 80 mm extension
- Stackable
- Fastening hole open, including cheese head screw
- Suitable for all BESSEY BAS clamps

Table of dimensions BAS

| | Clamping height "a" | Opening opt. "a1" | Throat depth "b" | Distance "b1" | Clamping arm "l" | Housing height "H" | Socket head screws | Fastening hole | Clamping force max. |
|--|---------------------|-------------------|------------------|---------------|------------------|--------------------|--------------------|--|---------------------|
| | mm | mm | mm | mm | mm | mm | DIN 912 | | N |
| BAS-C9-4  | 88 | 42 | 40 | 36.5 | 75 | 78 | M10 / M12 | open  | 16,000 |
| BAS-C10-6  | 97 | 42 | 60 | 36.5 | 94 | 78 | M10 / M12 | | 12,000 |
| BSP-C10-6  | 97 | 42 | 60 | 36.5 | 94 | 78 | M10 / M12 | 12,000 | |
| BAS-CB9-4  | 88 | 42 | 40 | 36.5 | 75 | 78 | M10 / M12 | closed  | 16,000 |
| BAS-CB10-6  | 97 | 42 | 60 | 36.5 | 94 | 78 | M10 / M12 | | 12,000 |
| BSP-CB10-6  | 97 | 42 | 60 | 36.5 | 94 | 78 | M10 / M12 | | 12,000 |
| BASO | 80 | - | - | - | - | 80 | M10 / M12 | open | - |

Machine table clamps



- Clamping force up to 10,000 N
- Tilting and infinitely height-adjustable
- For drilling and light milling work
- Lever mechanism for rapid clamping and release



Hold down table clamps BS



| No | Clamping height | | <x> | | | | V3 |
|------|-----------------|-----|------------|------|------|------|----|
| | mm | mm | mm | mm | kg | qty. | |
| BS2N | 200 | 100 | 19.5 x 9.5 | 10.5 | 1.35 | 1 | |
| BS3N | 200 | 120 | 22 x 10.5 | 13 | 1.55 | 1 | |
| BS4N | 200 | 120 | 28 x 11 | 16.5 | 2.49 | 1 | |
| BS5N | 240 | 140 | 30 x 15 | 16.5 | 3.30 | 1 | |
| BS6N | 500 | 140 | 30 x 15 | 16.5 | 4.00 | 1 | |

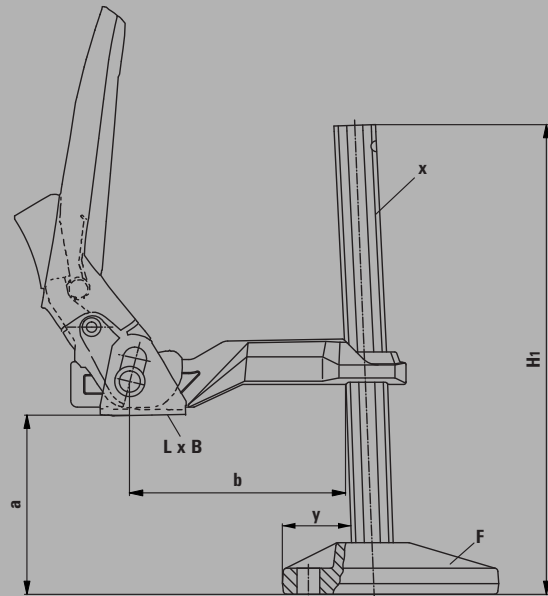

Claw machine clamp GRS



| No | Clamping height | | <x> | | | | V3 |
|----------|-----------------|---------|---------|------|------|------|----|
| | mm | mm | mm | mm | kg | qty. | |
| GRS20-12 | 200 | 123-140 | 28 x 11 | 16.5 | 2.81 | 1 | |

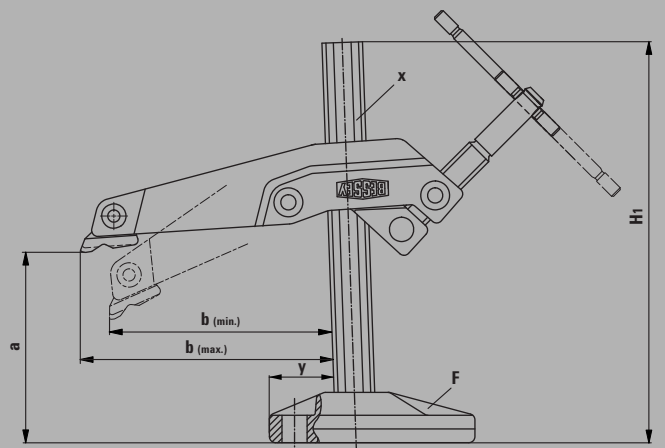

- Clamping force up to 7,500 N
- Swivelling, vertically infinitely adjustable clamp
- Externally-positioned spindle to allow unobstructed access to the work area and clamping in confined spaces
- For drilling and light milling work

3D CAD data for download at www.bessey.de

Machine table clamps



Hold down table clamps BSG



| N ^o | Clamping height | ← b → | ← x → | | | | V3 |
|----------------|-----------------|-------|---------|------|------|------|----|
| | mm | mm | mm | mm | kg | qty. | |
| BSG21-14 | 210 | 140 | 30 x 15 | 16.5 | 3.22 | 1 | |

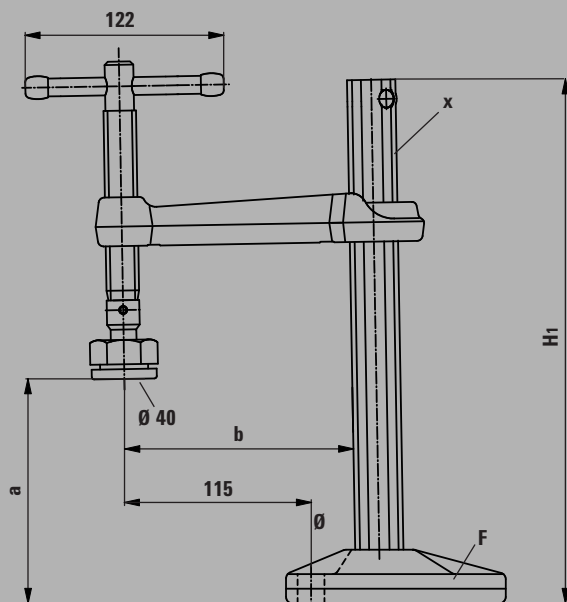

- Clamping force up to 12,000 N
- For fastening to tables and other equipment
- Long life due to heat-resistant pressure plate with sintered steel insert, which can be tilted up to 35°

Attachment TW28HO



| N ^o | Ø | Suitable for | | | V3 |
|----------------|----|---|------|------|----|
| | mm | | kg | qty. | |
| TW28HO | 28 | BAS-C / BAS-CB / BASO / BSN / GRS / BSG | 0.14 | 1 | |

- Accessory for BESSEY work table clamp
- It can be used on welding tables by simply screwing it to the work table clamp

Table of dimensions BS, GRS, BSG

| | Clamping height "a" | Throat depth "b" | Height of base "H1" | Pressure plate dimensions "L x B" | Foot "F" | | | Distance to the rail "y" | Rail profile mm | Fastening hole Ø | Achievable clamping force at a clamping height of 50 mm N |
|----------|------------------------|---------------------|------------------------|--------------------------------------|-------------------|------------------|-------------------|-----------------------------|--------------------|---------------------|--|
| | | | | | Foot length mm | Foot width mm | Foot height mm | | | | |
| BS2N | 200 | 100 | 260 | 42 x 25 | 100 | 38 | 25 | 32 | 19.5 x 9.5 | 10.5 | 3,500 |
| BS3N | 200 | 120 | 260 | 42 x 25 | 100 | 38 | 25 | 32 | 22 x 10.5 | 13 | 5,500 |
| BS4N | 200 | 120 | 270 | 48 x 31 | 135 | 49 | 33 | 42 | 28 x 11 | 16.5 | 7,500 |
| BS5N | 240 | 140 | 320 | 48 x 31 | 135 | 49 | 33 | 42 | 30 x 15 | 16.5 | 10,000 |
| BS6N | 500 | 140 | 580 | 48 x 31 | 135 | 49 | 33 | 42 | 27 x 13 | 16.5 | 10,000 |
| GRS20-12 | 200 | 123-140 | 265 | 25 x 35 | 135 | 48 | 33 | 42 | 28 x 11 | 16.5 | 7,500 |
| BSG21-14 | 210 | 140 | 322 | Ø 40 | 135 | 48 | 33 | 42 | 30 x 15 | 16.5 | 12,000 |

Self-adjusting toggle clamps

Self-adjusting jaw height for rapid clamping



Clamping up to
5 x faster

The power to be in position fast

With the patented self-adjusting toggle clamps from BESSEY, workpieces of differing heights can be clamped both quickly and securely. This makes them perfectly suited for use in small-scale production situations. However, it wouldn't be a BESSEY toggle lever clamp if our development team hadn't come up with another stand-out feature – true to our company motto "BESSEY. Simply better." – which is the ability to automatically adjust to different workpiece heights while also maintaining

constant clamping force. This makes time-consuming manual adjustment of the pressure screw a thing of the past. BESSEY toggle clamps have even more to offer when it comes to their flexibility; the clamping force can be optimized to the demands of the particular workpiece, simply by turning a set screw on the cantilevered joint. Furthermore, the hole pattern on the base plate has been designed to facilitate fast and secure clamping set-up. All this makes it an extremely flexible clamping tool – give it a try!

Self-adjusting toggle clamps

Highly flexible and up to 5 x faster



Uncompromisingly versatile

One size of the BESSEY toggle clamp replaces multiple competitor sizes simultaneously:

- due to an extremely large clamping range, thanks to the patented mechanism

More information



Ready to go – the first time and for quick set-up during workpiece changes

BESSEY STC toggle clamps adapt to workpieces of varying thickness – without manual setting of the spindle and, with practically the same clamping force:

- due to an automatic clamping width range

Powerful and gentle

Even sensitive workpieces, e.g. with veneered or varnished surfaces, can be gently clamped:

- due to moving pressure plate with removable protective cap
- due to clamping force regulation via adjustment screw in the joint

Self-adjusting toggle clamps



- Lever is in vertical clamping position
- Automatic, seamless adjustment of the clamping height up to 35 mm with almost constant clamping force – without manual changing of the pressing screw position
- Adjustable clamping force up to 2,500 N, based on the adjusting screw in the joint
- Sturdy, tempered sheet steel for longer service life
- Base plate hole pattern suitable for millimetres and inches
- High-quality, oil-resistant two-component plastic handle



Vertical toggle clamp with open arm and horizontal base plate STC-VH

| No | ← a → | Automatic adjustment | | | | V3 |
|----------|-------|----------------------|---------|------|------|----|
| | mm | mm | appr. N | kg | qty. | |
| STC-VH20 | 35 | 20 | 1,100 | 0.22 | 6 | |
| STC-VH50 | 40 | 35 | 2,500 | 0.43 | 6 | |

3D CAD data for download at <http://bessey.partcommunity.com> and www.bessey.de



Table of dimensions

| | | L1 | L2 | L3 | L4 | L5 | L6 | L7 | L8 | L9 | H1 | H2 | H3 | H4 | H5 | H6 | B1 | B2 | B3 | B4 | Lo1 | Lo2 | Lo3 | Lo4 | Ø |
|----------|----|------|------|------|------|----|------|------|------|------|------|------|------|------|------|----|-------|------|------|------|------|------|------|-----------|------|
| STC-VH20 | mm | 92 | 50 | 20 | 18.7 | – | 43 | 35 | 60 | 123 | 41 | 100 | 10 | 42 | 129 | – | 10 | 6 | 24 | 48 | 26 | 13 | 28 | 27-32 | 5.5 |
| | " | 3.62 | 1.97 | 0.79 | 0.74 | – | 1.69 | 1.38 | 2.36 | 4.84 | 1.61 | 3.94 | 0.39 | 1.65 | 5.08 | – | 0.39 | 0.24 | 0.94 | 1.89 | 1.02 | 0.51 | 1.10 | 1.06-1.26 | 0.22 |
| STC-VH50 | mm | 116 | 63 | 40 | 24.6 | – | 53 | 44 | 76 | 154 | 52 | 126 | 14 | 50 | 162 | – | 13.25 | 8.25 | 30 | 60 | 25.4 | 25.4 | 40 | 33-48 | 6.5 |
| | " | 4.57 | 2.48 | 1.57 | 0.97 | – | 2.09 | 1.73 | 2.99 | 6.06 | 2.05 | 4.96 | 0.55 | 1.97 | 6.38 | – | 0.52 | 0.32 | 1.18 | 2.36 | 1.00 | 1.00 | 1.57 | 1.30-1.89 | 0.26 |

STC-VH50

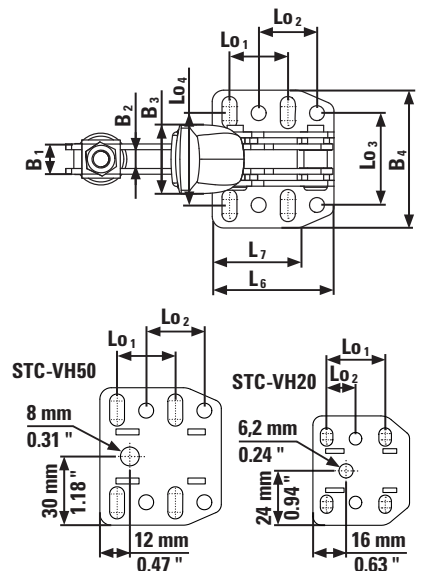
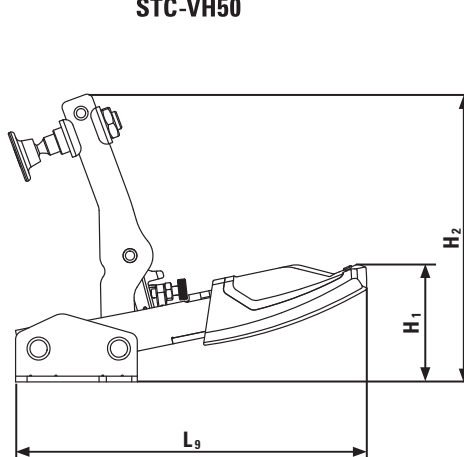
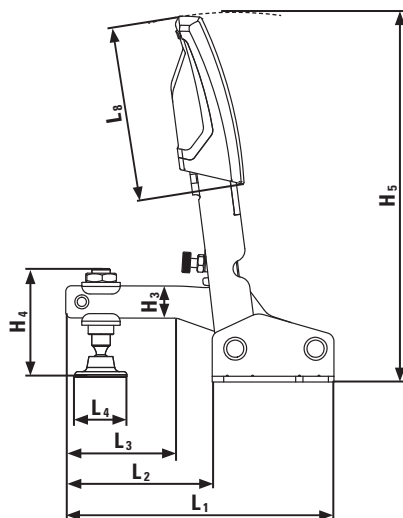

Self-adjusting toggle clamps



Horizontal toggle clamp with open arm and horizontal base plate STC-HH

| N ^o | ← a → | Automatic adjustment | | | | V3 |
|----------------|-------|----------------------|---------|------|------|----|
| | mm | mm | appr. N | kg | qty. | |
| STC-HH20 | 35 | 20 | 1,100 | 0.20 | 6 | |
| STC-HH20SB | 35 | 20 | 1,100 | 0.20 | 3 | |
| STC-HH50 | 40 | 35 | 2,500 | 0.38 | 6 | |
| STC-HH50SB | 40 | 35 | 2,500 | 0.38 | 3 | |
| STC-HH70 | 60 | 35 | 2,500 | 0.42 | 6 | |
| STC-HH70SB | 60 | 35 | 2,500 | 0.42 | 3 | |

3D CAD data for download at <http://bessey.partcommunity.com> and www.bessey.de



- In the clamped position, the lever is horizontal
- Automatic and infinitely variable adjustment of the clamping height up to 35 mm while clamping force remains unchanged – without having to make manual changes to the position of the pressure screws
- Clamping force is variable up to 2,500 N depending on the adjustment of the set screw in the cantilevered joint
- Sturdy, tempered metal sheets for a long service life
- Hole pattern on the base plate designed to facilitate fast and secure clamping set-up for metric and imperial
- High-quality oil resistant two-component plastic handle

Table of dimensions

| | | L1 | L2 | L3 | L4 | L5 | L6 | L7 | L8 | L9 | H1 | H2 | H3 | H4 | H5 | H6 | B1 | B2 | B3 | B4 | Lo1 | Lo2 | Lo3 | Lo4 | Ø |
|----------|----|------|------|------|------|------|------|------|------|----|------|------|------|------|------|----|------|------|------|------|------|------|------|-----------|------|
| STC-HH20 | mm | 169 | 58 | 39 | 18.7 | 91 | 43 | 32 | 50 | – | 38 | 125 | 11 | 42 | 22 | – | 10 | 6 | 26 | 48 | 25.7 | 12.7 | 28 | 27-32 | 5.5 |
| | " | 6.65 | 2.28 | 1.54 | 0.74 | 3.58 | 1.69 | 1.26 | 1.97 | – | 1.50 | 4.92 | 0.43 | 1.65 | 0.87 | – | 0.39 | 0.24 | 1.02 | 1.89 | 1.01 | 0.50 | 1.10 | 1.06-1.25 | 0.22 |
| STC-HH50 | mm | 217 | 77 | 40 | 24.6 | 113 | 53 | 38 | 72 | – | 47 | 158 | 14 | 50 | 27 | – | 13 | 8 | 32 | 60 | 25.4 | 25.4 | 38 | 33-48 | 6.5 |
| | " | 8.54 | 3.03 | 1.57 | 0.97 | 4.45 | 2.09 | 1.50 | 2.83 | – | 1.85 | 6.22 | 0.55 | 1.97 | 1.06 | – | 0.51 | 0.31 | 1.26 | 2.36 | 1.00 | 1.00 | 1.50 | 1.30-1.89 | 0.26 |
| STC-HH70 | mm | 217 | 77 | 40 | 24.6 | 113 | 53 | 38 | 72 | – | 64 | 175 | 14 | 68 | 44 | – | 13 | 8 | 32 | 60 | 25.4 | 25.4 | 38 | 33-48 | 6.5 |
| | " | 8.54 | 3.03 | 1.57 | 0.97 | 4.45 | 2.09 | 1.50 | 2.83 | – | 2.52 | 6.89 | 0.55 | 2.68 | 1.73 | – | 0.51 | 0.31 | 1.26 | 2.36 | 1.00 | 1.00 | 1.50 | 1.30-1.89 | 0.26 |

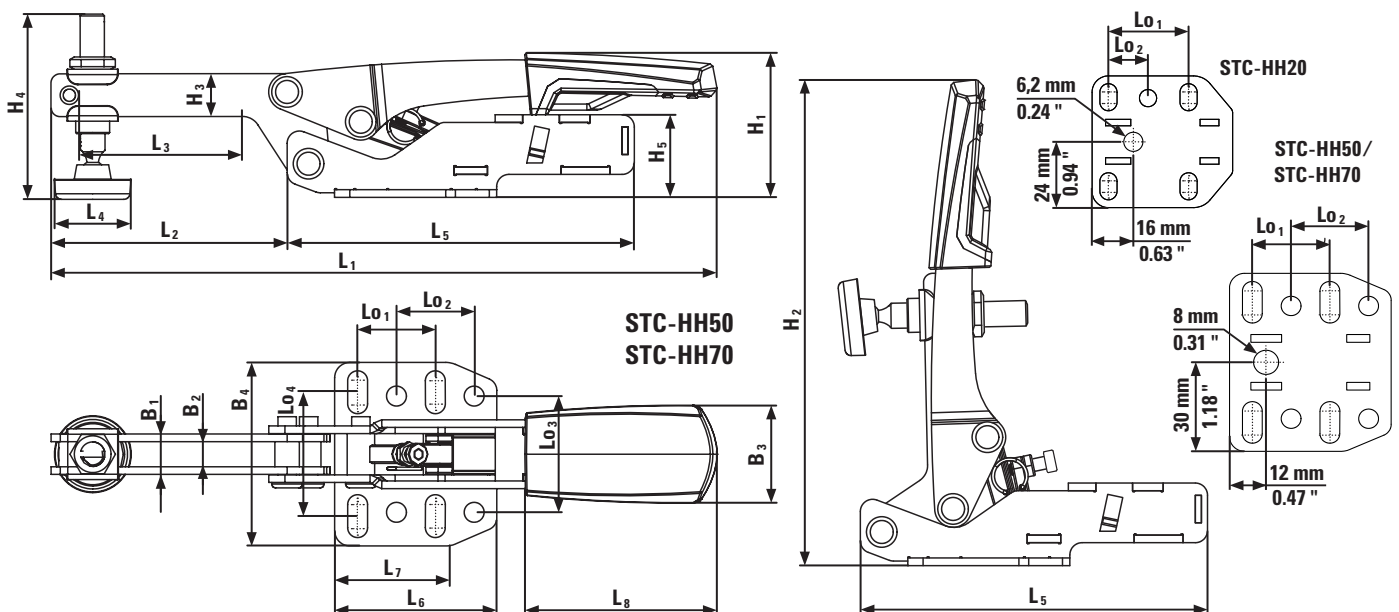

Self-adjusting toggle clamps



Push/pull clamp with horizontal base plate STC-IHH

- Moving the handle moves the push-pull rod
- Automatic and infinitely variable adjustment of the clamping height up to 13 mm while clamping force remains unchanged – without having to make manual changes to the position of the pressure screws
- Adjustable clamping force up to 2,500 N, based on the adjusting screw in the joint
- Sturdy, tempered metal sheets for a long service life
- Base plate hole pattern suitable for millimetres and inches
- High-quality oil resistant two-component plastic handle



| No | ← a → | Automatic adjustment | | | | V3 |
|-------------|-------|----------------------|---------|------|------|----|
| | mm | mm | appr. N | kg | qty. | |
| STC-IHH15 | 25 | 8 | 1,100 | 0.19 | 6 | |
| STC-IHH25 | 35 | 13 | 2,500 | 0.45 | 6 | |
| STC-IHH25SB | 35 | 13 | 2,500 | 0.46 | 3 | |

3D CAD data for download at <http://bessey.partcommunity.com> and www.bessey.de



Table of dimensions

| | | L1 | L2 | L3 | L4 | L5 | L6 | L7 | L8 | L9 | H1 | H2 | H3 | H4 | H5 | H6 | B1 | B2 | B3 | B4 | Lo1 | Lo2 | Lo3 | Lo4 | Ø |
|-----------|----|------|----|----|------|------|------|------|------|----|------|------|----|----|------|------|------|----|------|------|------|------|------|-----------|------|
| STC-IHH15 | mm | 178 | – | – | 18.7 | 122 | 43 | 32 | 50 | – | 36 | 122 | – | – | 20 | 21.6 | 8.5 | – | 26 | 48 | 25.7 | 12.7 | 28 | 27-32 | 5.5 |
| | " | 7.01 | – | – | 0.74 | 4.80 | 1.69 | 1.26 | 1.97 | – | 1.42 | 4.80 | – | – | 0.79 | 0.85 | 0.33 | – | 1.02 | 1.89 | 1.01 | 0.50 | 1.10 | 1.06-1.25 | 0.22 |
| STC-IHH25 | mm | 233 | – | – | 24.6 | 154 | 53 | 38 | 73 | – | 46 | 155 | – | – | 25 | 27 | 12 | – | 32 | 60 | 25.4 | 25.4 | 38 | 33-48 | 6.5 |
| | " | 9.17 | – | – | 0.97 | 6.06 | 2.09 | 1.50 | 2.87 | – | 1.81 | 6.10 | – | – | 0.98 | 1.06 | 0.47 | – | 1.26 | 2.36 | 1.00 | 1.00 | 1.50 | 1.30-1.89 | 0.26 |

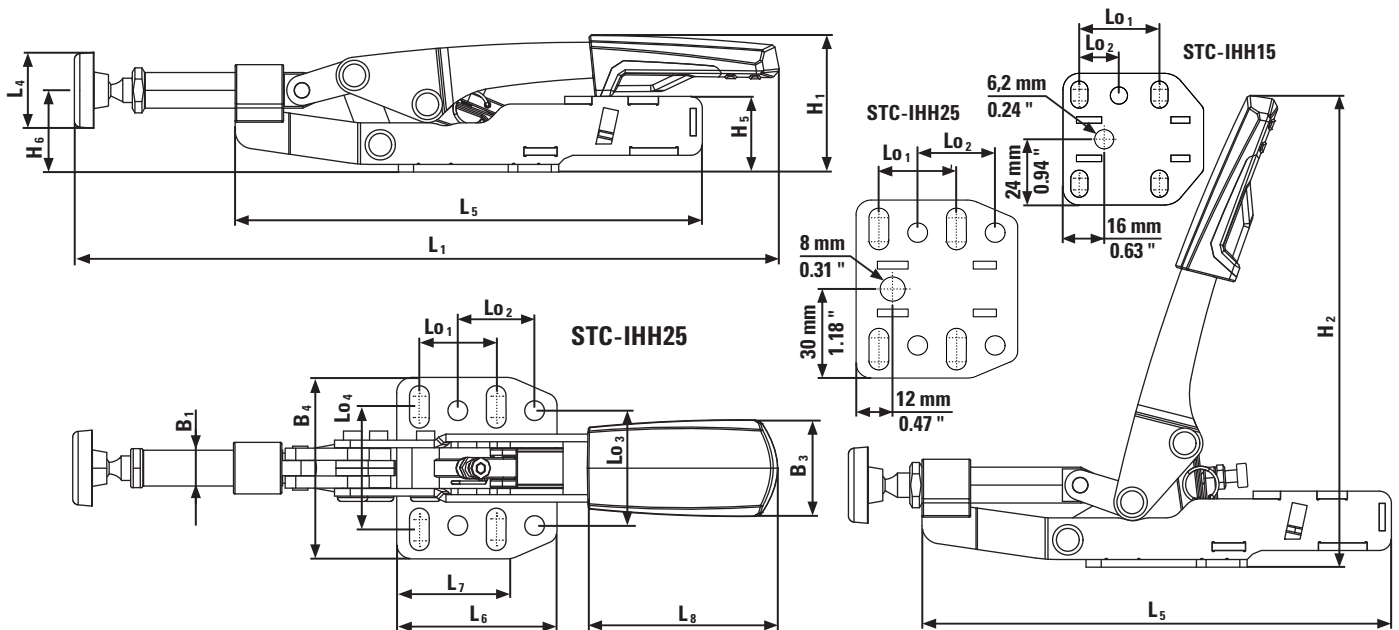

Clamping elements for multifunction tables



STC accessory set for multifunction tables



| N ^o | Contents/pc. | ← a → | Automatic adjustment | | | | V3 |
|----------------|---------------------------------------|-------|----------------------|-------|------|---|----|
| | | mm | mm | | | | |
| STC-HH50-T20 | 1 x STC-HH50 + 1 x STC-SET-T20 | 40 | 35 | 2,500 | 0.47 | 6 | |
| STC-HH70-T20 | 1 x STC-HH70 + 1 x STC-SET-T20 | 60 | 35 | 2,500 | 0.51 | 6 | |
| STC-IHH25-T20 | 1 x STC-IHH25 + 1 x STC-SET-T20 | 35 | 13 | 2,500 | 0.54 | 6 | |
| STC-VH50-T20 | 1 x STC-VH50 + 1 x STC-SET-T20 | 40 | 35 | 2,500 | 0.52 | 6 | |



- For using the BESSEY toggle clamps on multifunction tables such as Festool MFT and Sortimo WorkMo with hole diameter of 20 mm and plate thickness of min. 19 mm to max. 25 mm



Adapter for multifunction tables STC-SET-T20



| N ^o | Contents/pc. | Suitable for | | | V3 |
|----------------|---|---|------|------|----|
| | | | kg | qty. | |
| STC-SET-T20 | 1 x Cylindrical screw DIN 912 M 8 x 35 1 x Lock pin D 20 x 17 1 x Knurled nut M 8 | STC-HH50 STC-HH70 STC-IHH25 STC-VH50 | 0.09 | 6 | |



- For using the BESSEY toggle clamps on multifunction tables such as Festool MFT and Sortimo WorkMo with hole diameter of 20 mm and plate thickness of min. 19 mm to max. 25 mm

Parallel clamps and area pressure clamps

Large-area clamping and spreading

The evolution of the
REVO body clamp



Ideal for sensitive workpieces and right angles

The large, perfectly parallel jaw faces are characteristic of the original BESSEY K Body REVO parallel clamp. It allows easy clamping and spreading of sensitive surfaces and right angles. Even round and pointed workpieces. And the best thing is: thanks to

their extra-large contact surfaces, the original BESSEY K Body REVO parallel clamp and the lightweight parallel clamp UniKlump are both universally applicable – even behind and to the side of the high-quality profiled rail. This allows you to clamp in locations that conventional screw clamps are unable to reach. That's guaranteed!

REVO Evolution parallel clamp



The evolution of the REVO – greater power and safety in a new design

Precise and gentle

Workpieces with sensitive surfaces can be clamped and spread exactly parallel to each other – even behind and on the side of the rail. Corners and recessed edges as well as pointed and round surfaces can also be perfectly aligned:

- due to extremely large clamping surfaces that are attached perpendicular to the rail
- due to three removable pressure caps that are repellent to glue, and also resistant to paint and grease solvents
- due to workpiece supports that prevent the workpiece from coming into contact with the rail



Powerful and safe

They securely clamp with a clamping force of up to 8,000 N:

- due to the metal-reinforced plastic housing
- due to the optimised sliding arm with double slide protection: It holds the clamp reliably with the set clamping force and prevents any unintentional slipping of the sliding arm in the unclamped condition



REVOLUTION

Versatile and well thought out

The clamps provide an enormous number of possible applications:

- due to ingenious accessories, such as tilting adapter, frame press set, clamp extension and table clamp
- the ergonomically formed 2-component symmetrical plastic handle with hexagon socket means the clamping force can be comfortably applied (max. torque 17 Nm)
- the continuously adjustable head for the KREV Vario version enables the clamp to be positioned in the middle of the workpiece for optimum weight distribution



You Tube



Parallel clamps and area pressure clamps



- Clamping force up to 8,000 N
- Very large parallel clamping surfaces with 3 removable pressure caps
- Metal-reinforced plastic housing and optimised sliding arm with double slide protection for more power and safety: The set clamping force is maintained and the sliding arm cannot unintentionally slip in the unclamped condition
- Can be converted without tools for spreading tasks
- High-quality 2-component symmetrical plastic handle with hexagon socket for the comfortable application of the clamping force (max. torque 17 Nm)
- KREV with continuously adjustable and fixable upper section for optimum positioning on the workpiece



Vario K Body REVO parallel clamp KREV

| N ^o | <a> | | <e> | <x> | ⚖️ | 📦 | V3 |
|----------------|------|-----|----------|--------|------|------|----|
| | mm | mm | mm | mm | kg | qty. | |
| KREV100-2K | 1000 | 95 | 260-1130 | 29 x 9 | 3.77 | 2 | |
| KREV150-2K | 1500 | 95 | 260-1610 | 29 x 9 | 4.25 | 2 | |
| KREV200-2K | 2000 | 95 | 260-2080 | 29 x 9 | 5.30 | 2 | |
| KREV250-2K | 2500 | 95 | 260-2580 | 29 x 9 | 6.30 | 2 | |

K Body REVO parallel clamp KRE

| N ^o | <a> | | <e> | <x> | ⚖️ | 📦 | V3 |
|----------------|------|-----|----------|--------|------|------|----|
| | mm | mm | mm | mm | kg | qty. | |
| KRE30-2K | 300 | 95 | 255-390 | 29 x 9 | 2.15 | 2 | |
| KRE60-2K | 600 | 95 | 255-730 | 29 x 9 | 2.76 | 2 | |
| KRE80-2K | 800 | 95 | 255-930 | 29 x 9 | 3.10 | 2 | |
| KRE100-2K | 1000 | 95 | 255-1130 | 29 x 9 | 3.45 | 2 | |
| KRE125-2K | 1250 | 95 | 255-1355 | 29 x 9 | 3.87 | 2 | |
| KRE150-2K | 1500 | 95 | 255-1610 | 29 x 9 | 4.28 | 2 | |
| KRE200-2K | 2000 | 95 | 255-2080 | 29 x 9 | 5.09 | 2 | |
| KRE250-2K | 2500 | 95 | 255-2580 | 29 x 9 | 6.05 | 2 | |

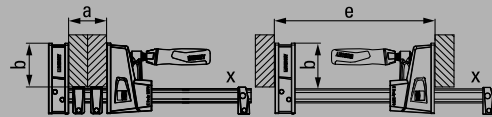

Parallel clamps and area pressure clamps



Variable jaw KRE-VO



| N ^o | Suitable for | kg | qty. | V3 |
|----------------|-----------------------|------|------|----|
| KRE-VO | KRE / KREV / KR / KRV | 1.58 | 1 | |



- Steplessly adjustable and fixable upper section for improved workpiece positioning
- Very large parallel clamping surfaces
- With 2 pressure caps to protect delicate surfaces
- Can be converted to spreading function with no need for tools



Framing set KP



| N ^o | Suitable for | kg | qty. | V3 |
|----------------|-----------------------|------|------|----|
| KP | KRE / KREV / KR / KRV | 0.55 | 1 | |

Contents: 4 rail couplings and 4 adapters



- KP Framing System (from 30 cm to 250 cm/12"-98") with four 90° KP Blocks
- Separately adjustable clamping force with 2 inserted clamps per corner
- Lightweight / easy to assemble
- On carded hang pack

Parallel clamps and area pressure clamps

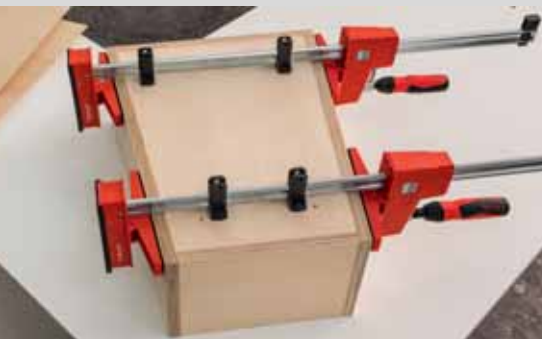

- Adapter with tilting clamping jaws with a tilt range of -15° to $+15^{\circ}$
- Clamping on sloping and parallel surfaces
- On carded hang pack



Tilting K Body clamp adapter KR-AS (2 pcs./bag)

| N ^o | Suitable for | | | | | V3 |
|----------------|-----------------------|-----|----|------|------|----|
| | | mm | mm | kg | qty. | |
| KR-AS | KRE / KREV / KR / KRV | 170 | 25 | 0.18 | 12 | |

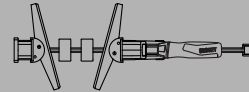

- Connect any two K Body parallel clamps to increase the clamping capacity. The connector is made of robust aluminum.
- On carded hang pack



K Body parallel clamp extender KBX

| N ^o | Suitable for | | | V3 |
|----------------|-----------------------|------|------|----|
| | | kg | qty. | |
| KBX20 | KRE / KREV / KR / KRV | 0.75 | 12 | |

- Especially for DIY applications and domestic appliances
- Special accessory for angle clamps WS 3/WS 6, screw clamp S 10 and K Body REVO parallel clamps KRE/KREV and KR/KRV to hold them to a work surface edge



Table clamp

| N ^o | \varnothing | <a> | | | | V3 |
|----------------|---------------|-----|-----|------|------|----|
| | mm | mm | mm | kg | qty. | |
| TK6 | 8 | 60 | 22 | 0.10 | 10 | |
| RB269 | 8 | 60 | 28 | 0.19 | 1 | |
| LM10/5R8 | 8 | 100 | 50 | 0.22 | 1 | |
| LM15/5R8 | 8 | 150 | 50 | 0.25 | 1 | |

Parallel clamps and area pressure clamps



Lightweight parallel clamp UK UniKlamp



| No | <a> | | <e> | <x> | kg | qty. | V3 |
|------|-----|-----|---------|--------|------|------|----|
| | mm | mm | mm | mm | | | |
| UK16 | 160 | 80 | 172-270 | 20 x 5 | 0.62 | 6 | |
| UK30 | 300 | 80 | 172-415 | 20 x 5 | 0.72 | 6 | |
| UK60 | 600 | 80 | 172-720 | 20 x 5 | 0.93 | 6 | |

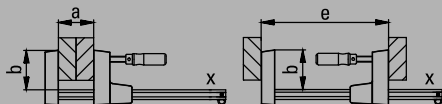

- Clamping force up to 1,500 N
- Parallel jaw faces with extra-large contact surfaces
- Clamping of various shapes, along the whole length of the rail
- Universally applicable
- Light and easy-to-handle
- No need for tools for switching between clamping and spreading
- On carded hang pack



Area pressure clamps FK



| No | <a> | | <x> | kg | qty. | V3 |
|---------|-----|-----|------------|------|------|----|
| | mm | mm | mm | | | |
| FK16-8 | 160 | 80 | 16 x 7.5 | 0.60 | 10 | |
| FK20-10 | 200 | 100 | 19.5 x 9.5 | 1.10 | 10 | |
| FK40-10 | 400 | 100 | 19.5 x 9.5 | 1.40 | 5 | |

- Clamping force up to 5,000 N
- 2 large, tilting jaw faces
- For workpieces with a sloping contact surface
- Large-area clamping of all workpieces from both sides



Box clamp KS

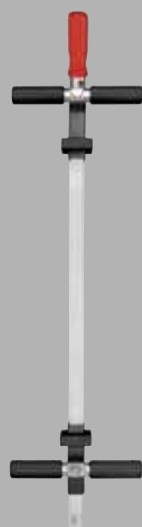

| No | <a> | | kg | qty. | V3 |
|-------|----------------|-----|------|------|----|
| | mm | mm | | | |
| KS100 | 200-1000 | 16 | 3.23 | 1 | |
| KS150 | 200-1500 | 16 | 3.94 | 1 | |
| KSV | Extension 1000 | - | 1.52 | 1 | |



- Clamping force up to 5,000 N
- Infinitely adjustable clamping jaws
- Clamp on angled and parallel surfaces

Gearclamp

Works "big" in a small space



Make the impossible possible!

With the new GearKlamp from BESSEY, you get a solution for conveniently clamping work even in the tightest spaces. To do this, BESSEY separated the handle from the spindle and positioned it around the rail. The GearKlamp force is transferred due to the internal gear mechanism concealed in the sliding jaw. The new GearKlamp design is much more compact in comparison to classic screw clamps, lever

clamps and one-handed clamps, which gives the user key advantages: For one thing, there are no disruptive tool components in the work area for the mechanic to run into and thus damage the workpiece or even injure themselves. Ergonomic handling is guaranteed in every clamping situation. The result is not having to twist your hand and be more comfortable when working. Try it out – you'll be thrilled!

You Tube



Unique compact design

The GearKlamp is extremely flexible and can even be used in the tightest of spatial conditions:

- due to the patented mechanism that separates the handle from the spindle and positions it around the rail
- due to the crossed v-grooves on the upper section for securely holding round, pointed and angular components



Ergonomic use

The clamp contains all kinds of clamping technology and guarantees the user greater comfort:

- due to the high-quality two-component plastic handle for safe handling
- due to the quick-release shift button for quickly adjusting the sliding bar
- due to the swivelling pressure plate for exact alignment of the workpiece

Robust technology

Meeting the BESSEY quality promise was a focus in development, and so the transmission clamp is also a winning choice in terms of durability:

- due to the use of high-quality materials, such as fibreglass-reinforced polyamide for the top and bottom, as well as hardened, tempered and burnished steel for the profiled rails
- due to the sliding bar's plastic housing, the driving mechanism is protected from dust and splintering



GearKlamp GK

| № | ←a→ | ←b→ | ←x→ | ⚖ | 📦 | V3 |
|------|-----|-----|--------|------|------|----|
| | mm | mm | mm | kg | qty. | |
| GK15 | 150 | 60 | 19 x 6 | 0.62 | 6 | |
| GK30 | 300 | 60 | 19 x 6 | 0.73 | 6 | |
| GK45 | 450 | 60 | 19 x 6 | 0.84 | 6 | |
| GK60 | 600 | 60 | 19 x 6 | 0.94 | 6 | |



- High-quality two-component plastic handle positioned around the rail, so clamp can be used in tight spaces
- Clamping force up to 2,000 N
- Easy-to-move trapezoidal thread spindle with swivelling pressure plate
- Quick-release shift button to quickly adjust sliding bar
- On carded hang-pack

One-handed clamps

One-handed clamping



Working alone and need another hand?

This extremely sturdy original BESSEY one-handed clamp EHZ is perfect for all work that needs to be carried out with one hand – e.g. for overhead tasks,

or if a further tool needs to be used at the same time for aligning purposes. The BESSEY EHZ one-handed clamp enables you to hold or fix in place with just one hand. It also allows you to clamp just as powerfully as ever.

The one-handed clamp EHZ – the only with up to 3,500 N clamping power.



Your benefits at a glance:

- 1 Parallel handle with pump lever**
The ergonomically shaped handle with pump lever runs parallel to the rail. That way, balanced, safe handling is always guaranteed.
- 2 Rapid move button**
This button allows you to move the sliding arm at any time, quickly and with minimum effort.
- 3 Plastic pressure caps**
The removable plastic caps provide a non-marring soft touch for use with wood and finished metal surfaces.
- 4 Versatility**
Fixed arm and pressure plate are produced and tempered from a single piece of high quality BESSEY steel. Clamping is resilient and elastic.



One-handed clamp EHZ with 2-component handle



| N ^o | <a> | | <x> | ⚖ | 📦 | V2 |
|----------------|-----|-----|------------|------|------|----|
| | mm | mm | mm | kg | qty. | |
| EHZ30-2K | 300 | 100 | 19.5 x 9.5 | 1.25 | 6 | |
| EHZ60-2K | 600 | 100 | 19.5 x 9.5 | 1.67 | 6 | |



- Clamping force of up to 3,500 N
- Clamp and fix in place quickly and simply with just one hand
- With protection caps on the clamping surfaces
- On carded hang pack

One-handed clamps

One-handed clamping and spreading



An all-rounder for the workshop!

With the EZ, EZS and DUO one-handed clamps from BESSEY, the name says it all. They can be applied with just one hand and are an indispensable assistant in particular when it comes to work above

head height, and if a further tool is required for aligning purposes at the same time. All three clamps can be used to clamp and spread, guarantee a secure hold and also protect sensitive surfaces thanks to the large, soft protective caps.

One-handed clamps



Practical convenience

The entire range offers ergonomic handling, thanks to sophisticated technology:

- due to the high quality 2-component plastic handle with pump lever behind the rail for safe access from both directions
- due to the release handle integrated in the grip for quick adjustment of the sliding bar and for releasing the clamp

Multiple applications

The one-handed EZ range offers numerous possible applications:

- due to a diverse range in four sizes with clamping widths from 110 to 900 mm and clamping forces from 200 N to 2,700 N
- due to the cross prism integrated in the plastic protective caps for the secure fastening of round, pointed and angular pieces
- due to conversion of the top section from clamping to spreading – with sizes EZM, EZL and EZXL tool-free thanks to release mechanism at the touch of a button

Robust design

Modern aesthetics meet with longevity here:

- due to the use of high-quality materials, such as fibreglass-reinforced polyamide for the top and bottom, as well as hardened, tempered, and burnished steel for the profiled rails
- due to the plastic housing, the grip mechanism is protected from dust and chips

NEW



One-handed clamp EZ



| No | ←a→ | ←b→ | ←e→ | ←x→ | Contents/ pc. | ⚖️ kg | 📦 qty. | V3 |
|------------|-----|-----|----------|---------|------------------|----------|-----------|----|
| | mm | mm | mm | mm | | | | |
| EZS11-4SET | 110 | 40 | 80-190 | 7 x 2,5 | 2 x EZS11-4 | 0.12 | 10 | |
| EZM15-6 | 150 | 60 | 125-270 | 14 x 5 | - | 0.31 | 6 | |
| EZM30-6 | 300 | 60 | 125-420 | 14 x 5 | - | 0.38 | 6 | |
| EZL15-8 | 150 | 80 | 160-300 | 18 x 5 | - | 0.58 | 6 | |
| EZL30-8 | 300 | 80 | 160-450 | 18 x 5 | - | 0.68 | 6 | |
| EZL45-8 | 450 | 80 | 160-500 | 18 x 5 | - | 0.77 | 6 | |
| EZL60-8 | 600 | 80 | 160-750 | 18 x 5 | - | 0.86 | 6 | |
| EZXL30-9 | 300 | 90 | 195-490 | 22 x 8 | - | 1.24 | 6 | |
| EZXL60-9 | 600 | 90 | 195-790 | 22 x 8 | - | 1.57 | 6 | |
| EZXL90-9 | 900 | 90 | 195-1090 | 22 x 8 | - | 1.90 | 6 | |

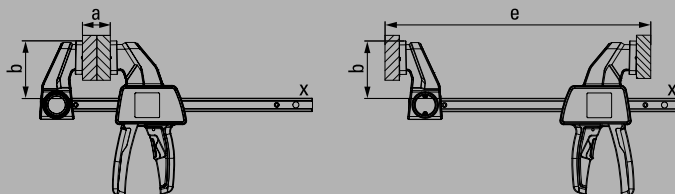

- Clamping force up to 2,700 N
- Conversion for spreading – tool-free with EZM, EZL, EZXL thanks to simple release mechanism at the touch of a button on the top section
- Ergonomically shaped 2-component plastic handle with pump mechanism and integrated release lever behind the rail
- Protective caps with cross prism on the top for securely holding round, pointed and angular parts
- One-handed operation with little effort required
- On carded hang pack

One-handed clamps

One-handed clamping and spreading



Your benefits at a glance:

1 Reversing

Don't disassemble the clamp – JUST TURN THE KNOB! The practical turning knob allows you to switch easily at any time from clamping to spreading.

2 Parallel handle with pump lever

The ergonomically shaped handle with pump lever runs parallel to the rail. That way, balanced, safe handling is always guaranteed.

3 Rapidly-adjustable release lever

A press of a button is all it takes: the release lever allows the clamp to be immediately released, as well as rapidly adjusted.

4 Large jaw faces

The large, planar jaw faces made from impact- and fracture-resistant reinforced polyamide are exactly parallel. For gentle clamping of a very wide range of different shapes over the entire length of the rail, without spacers.



One-handed clamp DuoKlamp DUO

| N ^o | <a> | | <e> | <f> | <x> | kg | qty. | V3 |
|----------------|-----|-----|--------|-------|--------|------|------|----|
| | mm | mm | mm | mm | mm | | | |
| DUO16-8 | 160 | 85 | 75-235 | 9-170 | 20 x 5 | 0.66 | 6 | |
| DUO30-8 | 300 | 85 | 75-380 | 9-315 | 20 x 5 | 0.72 | 6 | |
| DUO45-8 | 450 | 85 | 75-535 | 9-470 | 20 x 5 | 0.83 | 6 | |
| DUO65-8 | 650 | 85 | 75-685 | 9-660 | 20 x 5 | 1.02 | 6 | |

- Clamping force up to 1,200 N
- Change from clamping to spreading by switching, not converting
- Handle with pump lever parallel to the rail
- Convenient one-handed operation, with little effort required
- All-round clamping – in front of, behind and at the side of the rail
- On carded hang pack



Your benefits at a glance:

- 1 Powerful technology**
The extremely sophisticated technology makes it possible – single-handed clamping and spreading of workpieces with up to 2,000 N clamping force.
- 2 Intelligent release mechanism**
Thanks to the intelligent release mechanism, the upper section can be quickly converted from clamping to spreading without the need for tools.
- 3 Handle behind the rail**
The ergonomically shaped 2-component plastic handle with pump lever is positioned behind the rail, enabling a powerful grip.
- 4 Protective caps**
The protective caps on the clamping surfaces guarantee material protection and secure clamping.



One-handed clamp EZS



| N ^o | <a> | | <e> | <x> | ⚖ | 📦 | V3 |
|----------------|-----|-----|----------|--------|------|------|----|
| | mm | mm | mm | mm | kg | qty. | |
| EZS15-8 | 150 | 80 | 170-360 | 19 x 6 | 0.72 | 6 | |
| EZS30-8 | 300 | 80 | 170-510 | 19 x 6 | 0.83 | 6 | |
| EZS45-8 | 450 | 80 | 170-660 | 19 x 6 | 0.93 | 6 | |
| EZS60-8 | 600 | 80 | 170-810 | 19 x 6 | 1.04 | 6 | |
| EZS90-8 | 900 | 80 | 170-1110 | 19 x 6 | 1.26 | 6 | |

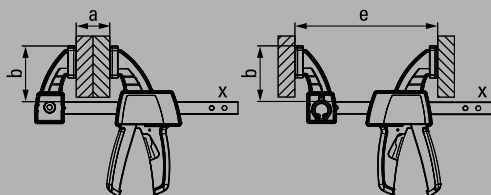

- Clamping force up to 2,000 N
- No tools required for spreading thanks to intelligent release mechanism in upper section
- Ergonomically shaped 2-component plastic handle behind the rail
- On carded hang pack

Rafter clamps

Clamping wooden frames, rafters and beams



Strong clamping with versatility

The **BESSEY** rafter clamp is the essential professional tool for roof and wood constructions.

Its movable sliding arm means it can be employed as a beam clamp at a moment's notice: Simply drive in the point, close the clamp, clamp it up to a high pressure – and that's all!

Rafter clamp SPZ – the versatile professional tool for roof and wooden constructions.



Your benefits at a glance:

- 1 Hammer-in tip**
First of all, the tip is driven into the rafter. The clamp is then quickly closed, to allow you to start right away with powerful clamping.
- 2 Broad impact surface**
The broad impact surface makes it easier to drive in the clamp.
- 3 Special tilting pressure plate**
With the SPZ 80 K, the special tilting pressure plate ensures problem-free clamping even when working with sloping parts. It can be tilted by up to 35°.
- 4 Sturdy hexagonal bolt**
The SPZ 80 K's tough hexagonal bolt allows powerful yet controlled tightening, with the help of a torque wrench.



Rafter clamp SPZ



| № | <a> | | <x> | kg | qty. | V2 |
|--------|-----|-----|---------|------|------|----|
| | mm | mm | mm | | | |
| SPZ60K | 600 | 120 | 27 x 13 | 2.90 | 5 | |
| SPZ80K | 800 | 140 | 30 x 15 | 5.00 | 2 | |

- Clamping force up to 12,000 N
- For all roofing and timber frame constructions
- SPZ 80 K with 17 mm hexagonal bolt and heat-resistant pressure plate with sintered steel insert, which can be tilted up to 35°



Special pressure plate



| № | Description | Suitable for | V3 |
|---------|--------------|---|----|
| | | | |
| 3100736 | Standard | SLM, SGM, SGTM, STBM, STBVC, SGU, SLV, GSV, SPZ80K, TWM | |
| 3101192 | Serrated | SLM, SGM, SGTM, STBM, STBVC, SGU, SLV, GSV, SPZ80K, TWM | |
| 3101193 | V-grooved | SLM, SGM, SGTM, STBM, STBVC, SGU, SLV, GSV, SPZ80K, TWM | |
| 3101219 | Cutting ring | SLV, GSV, SPZ80K | |

- Long life due to heat-resistant pressure plate with sintered steel insert, which can be tilted up to 35°
- Three design versions:
 - Smooth faced (standard version)
 - Rough faced for secure clamping on dirty surfaces
 - V-groove face for round, oval and edged workpieces



Anti-slip clamping with the cutting ring pressure plate
While stocks last

Lightweight clamps

Rapid, gentle clamping



The generation of high-tech clamps

Thanks to BESSEY's continuous development work, new innovative clamping tools are appearing all the time. Produced from the highest-quality materials, using state-of-the-art techniques. Today, the focus is no longer on the clamping pressure – the key now is to come up with the most intelligent solution. A perfect example of high-tech clamps is the

innovative KliKlamp: it is easy to handle, light and convenient, making it the first choice every time for light to medium clamping pressures. It is suitable for professional and home use – from modelling to furniture construction, from plastic to Plexiglass. Incidentally, you will find some more lightweight clamps on the next few pages. Especially for rapid and gentle clamping!

The KliKlamp KLI – feather light yet ultra strong and ideal for both professional and home use.

The Wood Klemmy HKL – made from hardwood for quick, simple clamping.

Lightweight clamps



Lightweight clamps

The lightweight clamp made of magnesium



Light as a feather – tough as nails

Extremely lightweight, stable magnesium, fibre-glass reinforced plastics, and cold-drawn BESSEY quality steel: this optimum mixture is characteristic of the innovative high-tech KliKlamp lever clamp. That's why the smallest KliKlamp weighs just a tiny 260 g – simply ideal for assembly work or where several clamps are being used at once. The pressure is also built up easily and highly effectively: the ratchet mechanism lets you achieve a huge 1,200 N of clamping force quickly with just 2 fingers. You certainly will never have clamped as quickly, easily or as gently as this!

Your benefits at a glance:

- 1 Sturdy magnesium**
The surface-coated upper and lower sections made from sturdy magnesium are extremely light and strong.
- 2 Multi-stage ratchet mechanism**
The multi-stage ratchet mechanism is easy to operate, vibration-resistant, particularly easy to control, and can be released quickly.
- 3 A secure hold**
The fixed arm with the crossed v-grooves holds round, pointed or angular components firmly in place. This is part of what makes the KliKlamp so versatile.
- 4 Ergonomically shaped clamping arm**
The ergonomically shaped clamping arm made from fibreglass-reinforced polyamide is breakproof and fits very snugly in the hand. That's quality of the highest calibre.

Lightweight clamps



High-tech lever clamp KliKlamp KLI



| N ^o | <a> | | <x> | ⚖ | 📦 | V3 |
|----------------|-----|-----|--------|------|------|----|
| | mm | mm | mm | kg | qty. | |
| KLI12 | 120 | 80 | 20 x 5 | 0.26 | 6 | |
| KLI16 | 160 | 80 | 20 x 5 | 0.29 | 6 | |
| KLI20 | 200 | 80 | 20 x 5 | 0.32 | 6 | |
| KLI25 | 250 | 80 | 20 x 5 | 0.35 | 6 | |
| KLI30 | 300 | 80 | 20 x 5 | 0.38 | 6 | |
| KLI40 | 400 | 80 | 20 x 5 | 0.45 | 10 | |



- Clamping force up to 1,200 N
- Feather light yet ultra strong
- Sturdy fixed and sliding arms made from lightweight magnesium
- Quick and vibration free clamping
- On carded hang pack



High-tech lever clamp KliKlamp set in systainer KLI-S



| N ^o | Contents/pc. | ⚖ | 📦 | V3 |
|----------------|---------------------------------------|------|------|----|
| | | kg | qty. | |
| KLI-S | per 4 x KLI12 / KLI16 / KLI20 / KLI25 | 6.44 | 1 | |



- Practical systainer T-Loc, stackable
- Ideal for assembly work



High-tech lever clamp KliKlamp counter display KLI-D



| N ^o | Contents/pc. | ⚖ | 📦 | V3 |
|----------------|---|------|------|----|
| | | kg | qty. | |
| KLI-D | 2 x KLI12 / 4 x KLI16 / 6 x KLI20 / 4 x KLI25 | 5.63 | 1 | |

- Professional sales display
- Optimum presentation of the KliKlamp

Lightweight clamps

Small and very handy – U-Style



Your benefits at a glance:

- 1 Step-over clamping U-shape**
The rail is made of quality steel drawn in a single piece for durability and strength. The U-shape of the rail enables step-over clamping up to 20 mm so you can get to those hard-to-reach places.
- 2 Sliding arm**
The sliding arm is made of die-cast zinc. It is light, stable and break-resistant.
- 3 Protective caps**
Particularly sensitive workpieces are effectively protected thanks to the protective caps. For all-round gentle clamping.



- Clamping force up to 1,500 N
- Step-over clamping
- Comes with two protective caps
- Small and easy to handle
- Light weight



Light duty bar clamp U-style LMU

| № | <a> | | <x> | ⚖ | 📦 | V1 |
|---------|-----|-----|--------|------|------|----|
| | mm | mm | mm | kg | qty. | |
| LMU10/5 | 100 | 50 | 15 x 5 | 0.23 | 24 | |
| LMU15/5 | 150 | 50 | 15 x 5 | 0.27 | 24 | |
| LMU20/5 | 200 | 50 | 15 x 5 | 0.29 | 24 | |

The Light duty bar clamp U-style LMU will be delivered in an attractive sales presenter. Sale to dealers in packaging units only.



Lightweight clamps



Die-cast zinc screw clamp LM



| № | <a> | | <x> | ⚖ | 📦 | V1 |
|---------|-----|-----|--------|------|------|----|
| | mm | mm | mm | kg | qty. | |
| LM10/5 | 100 | 50 | 15 x 5 | 0.24 | 10 | |
| LM15/5 | 150 | 50 | 15 x 5 | 0.27 | 10 | |
| LM20/5 | 200 | 50 | 15 x 5 | 0.30 | 10 | |
| LM25/5 | 250 | 50 | 15 x 5 | 0.32 | 10 | |
| LM30/5 | 300 | 50 | 15 x 5 | 0.35 | 10 | |
| LM15/8 | 150 | 80 | 20 x 5 | 0.51 | 10 | |
| LM20/8 | 200 | 80 | 20 x 5 | 0.55 | 10 | |
| LM25/8 | 250 | 80 | 20 x 5 | 0.60 | 10 | |
| LM30/8 | 300 | 80 | 20 x 5 | 0.64 | 10 | |
| LM20/10 | 200 | 100 | 25 x 6 | 0.90 | 10 | |
| LM25/10 | 250 | 100 | 25 x 6 | 0.95 | 10 | |
| LM30/10 | 300 | 100 | 25 x 6 | 1.02 | 10 | |
| LM40/10 | 400 | 100 | 25 x 6 | 1.10 | 10 | |
| LM50/10 | 500 | 100 | 25 x 6 | 1.24 | 10 | |
| LM60/10 | 600 | 100 | 25 x 6 | 1.30 | 10 | |
| LM80/10 | 800 | 100 | 25 x 6 | 1.58 | 10 | |



- Clamping force up to 1,500 N
- Clamping arms manufactured in toughened die cast zinc black powder coated to prevent chemical corrosion
- Comes with protective cap
- Small and easy to handle
- Light weight



Wood Klemmy HKL



| № | <a> | | <x> | ⚖ | 📦 | V1 |
|--------|------|-----|--------|------|------|----|
| | mm | mm | mm | kg | qty. | |
| HKL20 | 200 | 110 | 20 x 5 | 0.32 | 10 | |
| HKL30 | 300 | 110 | 20 x 5 | 0.46 | 10 | |
| HKL40 | 400 | 110 | 20 x 5 | 0.54 | 10 | |
| HKL60 | 600 | 110 | 20 x 5 | 0.70 | 10 | |
| HKL80 | 800 | 110 | 20 x 5 | 0.86 | 10 | |
| HKL100 | 1000 | 110 | 20 x 5 | 1.00 | 10 | |

- Upper and lower arms and lever made from high-quality hardwood
- Cork pads for gentle clamping



Aluminium mini clamp AM



| № | <a> | | ⚖ | 📦 | V3 |
|-----|-----|-----|------|------|----|
| | mm | mm | kg | qty. | |
| AM4 | 47 | 34 | 0.06 | 10 | |

- Ideal for modelling and hobbyists
- Low weight of just 55 g



Parallel screw clamp PA



| № | <a> | | ⚖ | 📦 | V3 |
|-------|-----|-----|------|------|----|
| | mm | mm | kg | qty. | |
| PA28 | 36 | 19 | 0.08 | 1 | |
| PA40 | 46 | 26 | 0.10 | 1 | |
| PA55 | 60 | 35 | 0.18 | 1 | |
| PA70 | 87 | 50 | 0.43 | 1 | |
| PA105 | 116 | 72 | 0.92 | 1 | |

- Twin spindles
- Precisely parallel positioning of the jaw faces

Table vice

The exciting all-rounder for everyone

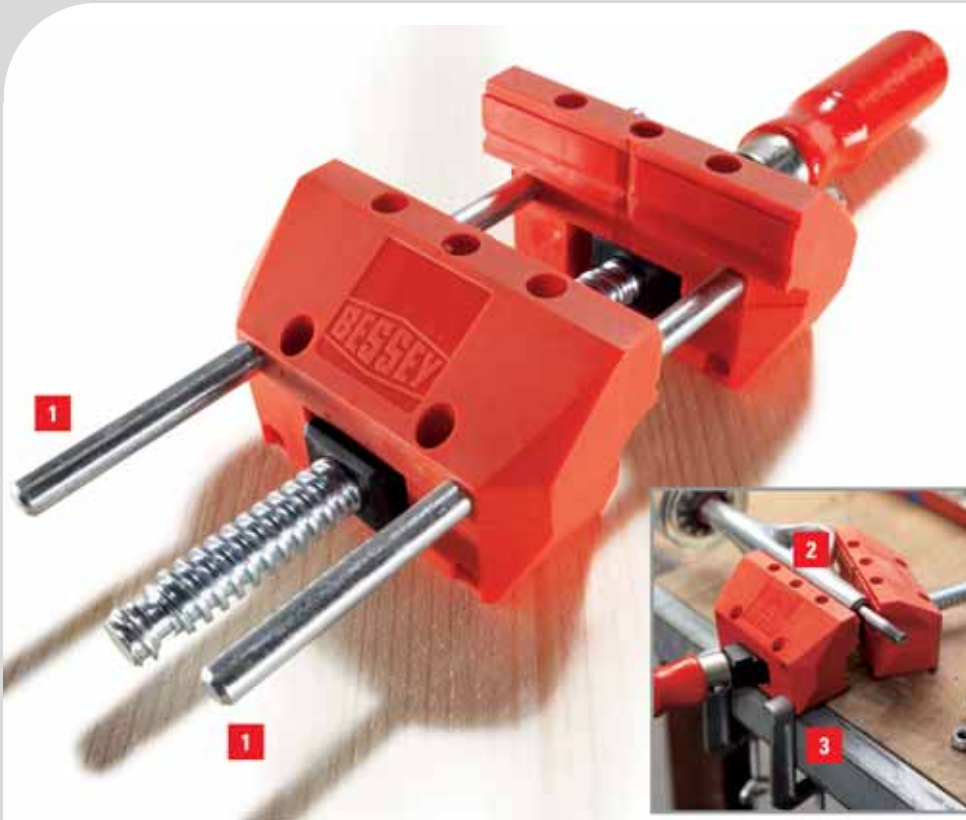

Your benefits at a glance:

- 1 Parallel clamping**
With guide rods, the mini vice S 10 is ideal for parallel clamping.
- 2 Clamping at an angle**
When used without guide rods, the screw clamp S 10 is ideal for clamping at an angle.
- 3 Easily mounted**
Two clips for quick and simple attachment to a table edge.

- Low weight
- Parallel clamping with guide rods
- Clamping at an angle without guide rods (max. 25°)
- Easy to attach, with 2 table clips supplied
- On carded hang pack

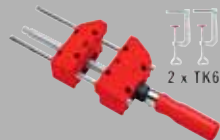

Mini Vice S 10

| No | <a> | | | | |
|--------|-----|----|------|------|----|
| | mm | mm | kg | qty. | V3 |
| S10-ST | 100 | 90 | 0.83 | 10 | |

- Especially for DIY applications and domestic appliances
- Special accessory for angle clamps WS 3/WS 6, screw clamp S 10 and K Body REVO parallel clamps KRE/KREV and KR/KRV to hold them to a work surface edge



Table clamp

| No | ∅ | <a> | | | | |
|----------|----|-----|-----|------|------|----|
| | mm | mm | mm | kg | qty. | V3 |
| TK6 | 8 | 60 | 22 | 0.10 | 10 | |
| RB269 | 8 | 60 | 28 | 0.19 | 1 | |
| LM10/5R8 | 8 | 100 | 50 | 0.22 | 1 | |
| LM15/5R8 | 8 | 150 | 50 | 0.25 | 1 | |

Table clamps

An ideal clamp for guide rails and workbenches



NEW



For rails and much more

This will elicit a surprised “wow” from many a user: The new EZR not only extends the BESSEY range of high quality table clamps with a one-handed version. Besides its actual purpose, it

has many other possible uses on top of that. Thanks to the many tool-free options for changing the upper part and adapter, there are always new applications for the clamp: for normal clamping or spreading as well as for step-over fixing work when the adapter is pushed onto the upper or lower part.

Table clamps

One clamp with many applications

Versatile use

This clamp offers many possible applications:

- with adapter on the bottom section and rotated top section for secure fastening of guide rails from Festool, Protool, Metabo, Makita, Hitachi/Hikoki, Dewalt, etc. and for clamping in profiles and on work benches
- with adapter on the top or bottom section for step-over clamping
- with or without adapter for clamping or spreading



Convenient technology

Ergonomic and safe handling, thanks to sophisticated technology:

- due to the high quality 2-part plastic grip with pump lever behind the rail for safe access from both directions
- due to the release handle integrated in the grip for quick adjustment of the sliding bar and for releasing the clamp
- due to the cross prism integrated in the plastic protective caps for the secure fastening of round, pointed and angular pieces

Robust design

Modern aesthetics meet with longevity here:

- due to the use of high-quality materials, such as fibreglass-reinforced polyamide for the top and bottom, as well as hardened, tempered, and burnished steel for the profiled rails
- due to the plastic housing, the grip mechanism is protected from dust and chips

You Tube



Table clamps



NEW



One-handed table clamp EZR



| N ^o | <a> | | <e> | <x> | Contents/ pc. | kg | qty. | V3 |
|----------------|-----|-----|---------|--------|------------------|------|------|----|
| | mm | mm | mm | mm | | | | |
| EZR15-6SET | 150 | 60 | 120-310 | 14 x 5 | 2 x EZR15-6 | 0.88 | 8 | |

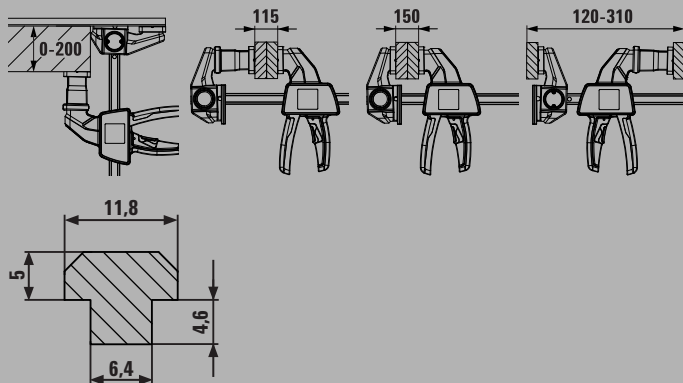

- With special guide on the top section for grooves 12 x 6.5 mm to 12 x 8 mm
- Use with adapter on the bottom section and rotated top section for secure fastening of guide rails from Festool, Protool, Metabo, Makita, Hitachi/Hikoki, Dewalt, etc. and for clamping in profiles and on work benches
- Use with adapter on the top or bottom section for step-over clamping
- Use with or without adapter – for clamping or spreading
- Clamping force up to 750 N
- Ergonomically shaped 2-part plastic handle with pump lever behind the rail
- On carded hang pack



All-steel table clamp GTR



| N ^o | <a> | | <x> | Contents/pc. | kg | qty. | V2 |
|----------------|-----|-----|------------|--------------|------|------|----|
| | mm | mm | mm | | | | |
| GTR12 | 120 | 60 | 13.5 x 6.5 | - | 0.30 | 10 | |
| GTR12SET | 120 | 60 | 13.5 x 6.5 | 2 x GTR12 | 0.61 | 5 | |
| GTR16B6 | 160 | 60 | 13.5 x 6.5 | - | 0.32 | 10 | |
| GTR30B6 | 300 | 60 | 13.5 x 6.5 | - | 0.40 | 10 | |



All-steel table clamp GTRH with lever handle



| N ^o | <a> | | <x> | kg | qty. | V2 |
|----------------|-----|-----|------------|------|------|----|
| | mm | mm | mm | | | |
| GTR16S6H | 160 | 60 | 13.5 x 6.5 | 0.53 | 10 | |

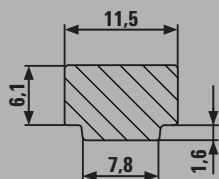

- Specially forged fixed arm for 12 x 8 mm grooves
- For secure fastening of guide rails from Festool, Protool, Metabo, Makita, Hitachi/Hikoki, etc. and for clamping in profiles as well as work tables
- GTR: Clamping force up to 1,800 N
- Ergonomically shaped wooden handle
- GTR12SET: On carded hang pack
- GTRH: Rapid – up to 5 times faster than conventional clamps
- Secure – unaffected by vibrations
- Strong – clamping force up to 2,400 N



Spring clamps

For flexible, featherlight clamping



Convenient clamping with constant clamping pressure

BESSEY's spring clamps are small... but rather special. That's because they lie perfectly in the hand, guaranteeing ease of handling. Even with

large opening widths, powerful, constant one-handed clamping is always possible. And the infinitely variable adjustment and protective caps mean that even the most delicate workpieces receive effective protection. After all, size isn't everything!

VarioClippix XV – suitable for one-handed use even at the maximum opening width of 170 mm.

Clippix XC – particularly easy to handle and suitable for all applications.

Spring clamps



Spring clamp VarioClippix XV



| N ^o | <a> | | | | kg | qty. | V3 |
|----------------|-----|---|-----|-------|------|------|----|
| | mm | " | mm | " | | | |
| XV3-50 | 55 | 2 | 37 | 1 1/2 | 0.07 | 12 | |
| XV5-100 | 100 | 4 | 50 | 2 | 0.17 | 12 | |

- Variable opening width up to 100 mm, yet can be operated with one hand
- Lightweight, functional and easy to handle
- Extremely sturdy
- On carded hang pack



Spring clamp VarioClippix XV



| N ^o | <a> | | | | kg | qty. | V3 |
|----------------|-----|-------|-----|---|------|------|----|
| | mm | " | mm | " | | | |
| XV5-170 | 170 | 6 1/2 | 50 | 2 | 0.19 | 12 | |

- Variable opening width up to 170 mm, yet can be operated with one hand
- Lightweight, functional and easy to handle
- Extremely sturdy
- On carded hang pack



Spring clamp Clippix XC



| N ^o | <a> | | | | Contents/ pc. | kg | qty. | V3 |
|----------------|-----|-------|-----|-------|------------------|------|------|----|
| | mm | " | mm | " | | | | |
| XC1/2 | | | | | | | | |
| XC1 | 20 | 3/4 | 20 | 3/4 | - | 0.01 | 10 | |
| XC1-SET | 20 | 3/4 | 20 | 3/4 | 7 x XC1 | 0.06 | 12 | |
| XC2 | 25 | 1 | 30 | 1 1/8 | - | 0.02 | 10 | |
| XC3 | 35 | 1 3/8 | 37 | 1 1/2 | - | 0.05 | 10 | |
| XC5 | 50 | 2 | 50 | 2 | - | 0.12 | 10 | |
| XC7 | 75 | 3 | 70 | 2 3/4 | - | 0.18 | 10 | |

- Lightweight, functional and easy to handle
- Extremely sturdy
- XC1-SET – On carded hang pack



Needle nose spring clamp Clippix XCL



| N ^o | <a> | | | | Contents/ pc. | kg | qty. | V3 |
|----------------|-----|-------|-----|-------|------------------|------|------|----|
| | mm | " | mm | " | | | | |
| XCL2 | 55 | 2 1/8 | 60 | 2 3/8 | - | 0.02 | 10 | |
| XCL2-SET | 55 | 2 1/8 | 60 | 2 3/8 | 2 x XCL2 | 0.04 | 10 | |
| XCL5 | 70 | 3 | 110 | 4 1/4 | - | 0.14 | 10 | |

- Long, pointed clamping arm for working in tight spaces
- Large throat depth for clamping in borderless areas
- Soft, slip-proof grip pads
- XCL2-SET – On carded hang pack

NEW



Spring clamp XM



| N ^o | <a> | | | | kg | qty. | V3 |
|----------------|-----|---|-----|--------|------|------|----|
| | mm | " | mm | " | | | |
| XM3EU | 25 | 1 | 32 | 1 1/4 | 0.07 | 48 | |
| XM5EU | 50 | 2 | 57 | 2 1/4 | 0.17 | 24 | |
| XM7EU | 75 | 3 | 85 | 3 5/16 | 0.42 | 10 | |

- XM3EU: Clamping force up to 100 N/10 kg
- XM5EU: Clamping force up to 120 N/12 kg
- XM7EU: Clamping force up to 150 N/15 kg
- Tips and handles made of PVC prevent marring
- Heavy duty springs for firm grip and powerful clamping
- Corrosion resistant nickel plated

Band clamps

Clamping frames and curves



For even clamping on both sides without warping or skewing of the workpiece

Clamping curves, polygonal connections and closed contours are traditionally some of the most difficult clamping jobs. BESSEY has come up with a startling solution to this problem: in the form of the patented band clamp BAN 700, and the

practical Vario corners. These two products are suitable for all those situations where gentle, non-warping, all-round clamping is needed. Universally applicable. For wood and plastic as well as in metal construction. Secured by an automatic locking system that ensures even tractive forces on both sides, which do not slacken until the clamp is released. No warping – no stress!

The band clamp BAN 700 and the Vario corners BVE – the perfect pair for gentle, non-warping clamping.

Band clamps



Band clamp BAN 700



| N ^o | Clamping range | Band w x d | | | | V3 |
|----------------|----------------|------------|----------|------|------|----|
| | | mm | | kg | qty. | |
| BAN700 | Up to 7 m | 25 x 1 | 60°-180° | 0.56 | 5 | |



- Even pressure on mitre joints
- Crank handle can be relocated for right and left-handed users
- Contains: 1 band clamp, 4 Vario corners
- On carded hang pack



Band clamp BAN 400



| N ^o | Clamping range | Band w x d | | | V3 |
|----------------|----------------|------------|------|------|----|
| | | mm | kg | qty. | |
| BAN400 | Up to 3.8 m | 24 x 1 | 0.48 | 12 | |



- Clamp right-angled workpieces with 4 plastic corners
- Even pressure at all 4 corners
- On carded hang pack



Vario corners BVE (6 pcs./bag)



| N ^o | Band w x d | | Suitable for | | | V3 |
|----------------|------------|----------|-------------------|------|------|----|
| | mm | | | kg | qty. | |
| BVE | 25 x 1 | 60°-180° | BAN700, BAN400 | 0.10 | 6 | |



- Infinite angle adjustment from 60-180°
- On carded hang pack

Angle and mitre clamps

Clamping angles and mitres



For all the toughest tasks

Clamping workpieces of different thicknesses, clamping directly into a mitre joint, clamping all kinds of angles: BESSEY has developed top-class-

special tools for solving all of these challenging clamping tasks. Whether angle clamps, mitre clamps or irregular angle clamps – we know what you really need!

The angle clamp WS – clamping workpieces of different thicknesses in a perfect right angle.

Angle and mitre clamps



Angle clamp WS



| № | <a> | | Current passage m | | | V3 |
|-----|---------|----|----------------------|------|----|----|
| | mm | | | | | |
| WS3 | 2 x 55 | 30 | 30 | 0.96 | 10 | |
| WS6 | 2 x 100 | 36 | 60 | 1.96 | 4 | |

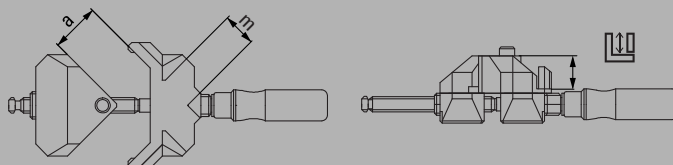

- Automatic adjustment to variously-sized workpieces
- Quick – clamp with a spindle
- Stable body
- For attaching with table clamp – available as an accessory
- WS 3 – on carded hang pack



Angle clamp WS



| № | <a> | | | | V3 |
|-----|--------|----|------|----|----|
| | mm | | | | |
| WS1 | 2 x 73 | 12 | 0.20 | 12 | |

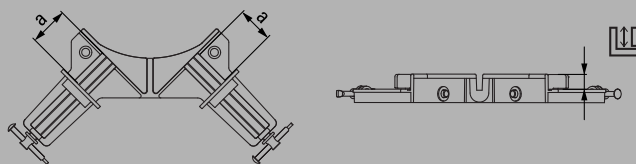

- Clamp variously-sized workpieces with 2 spindles
- For light clamping work
- Made from die-cast zinc
- On carded hang pack



Mitre clamping system MCX



∠ = 22,5° / 30° / 45° / 60°

| № | <a> | | | | V3 |
|-----|-----|-------------------|------|---|----|
| | mm | | | | |
| MCX | 100 | 22.5°/30°/45°/60° | 0.70 | 1 | |



- Mitre system for 22.5°, 30°, 45° and 60° angles
- Even pressure on the mitre
- Angle adapter can be changed without tools
- Practical accessory for BESSEY screw clamps TG,GZ, GMZ, EHZ, EZS and DUO

Edge clamps

For all edge clamping needs



Complete specialised tasks easily

Special tasks and applications often require the use of special tools. Which is why, for edge clamping,

BESSEY has come up with a series of light, easy-to-handle edge clamps. Also available for one-handed operation if required. Specially developed to make your day-to-day work even easier!

The one-handed edge clamp EKT – ideal for applying multi-layered edge strips with just one hand.

The edge clamp KT8-3 – a C-frame that is robust for heavy duty and high clamping pressures.



Your benefits at a glance:

- 1 Unique twin spindle**
The outer spindle acts on the clamping jaws. The inner spindle applies pressure to the front edge. And the impact resistant plastic handle for one-handed use means that any task or application is well within your grasp.
- 2 Large jaws**
Non-slip, gentle clamping. Max. opening distance: 55 mm. The large jaws with integrated colourless soft plastic caps increase the versatility of the clamp.
- 3 Swivel pressure plate**
The large pressure plate will swivel to apply pressure wherever it is required.
- 4 Light aluminium housing**
Lightweight yet highly effective. The statically-optimised aluminium housing creates a corrosion-resistant body for the convenient, one-handed edge clamp EKT.



One-handed edge clamp EKT



| N ^o | <a> | | ⚖ | 📦 | |
|----------------|-------|-----|------|------|----|
| | mm | mm | kg | qty. | V3 |
| EKT55 | 10-55 | 45 | 0.82 | 1 | |

- For rapid one-handed operation
- Low weight
- Opening up to 55 mm



Edge clamp Kantenfix KF



| N ^o | <a> | | ⚖ | 📦 | |
|----------------|-------|-----|------|------|----|
| | mm | mm | kg | qty. | V3 |
| KF2 | 10-40 | 80 | 0.68 | 4 | |
| KF4 | 10-80 | 110 | 1.48 | 4 | |

You Tube



- For quick one-handed operation
- Widths up to 80 mm



Edge clamps



- Practical accessory for clamping edges and difficult to reach areas
- Suitable for conventional screw clamps with a max. rail thickness of 13 mm



Edge clamp KT

| N ^o | Description |  |  | V1 |
|----------------|-------------|---|---|----|
| | | kg | qty. | |
| KT5-1CP | 1 spindle | 0.35 | 1 | |
| KT5-2 | 2 spindles | 0.58 | 1 | |



- Three-spindle C-frame clamp
- Extra strong, with forged frame
- Universally applicable within the fields of wood and metal processing
- Suitable for welding



C-frame edge clamp KT

| N ^o | <a> | |  |  | V3 |
|----------------|--------|-----|---|---|----|
| | mm | mm | kg | qty. | |
| KT8-3 | 0 - 80 | 80 | 2.37 | 5 | |



- Load-bearing capacity 75 kg
- For the safe lifting and carrying of panels such as wood sheets, chipboard panels, glass and plexiglass
- High-friction rubber coating on the moving clamping jaws



Panel carrier KFP

| N ^o | <a> |  |  | V3 |
|----------------|-------|---|---|----|
| | mm | kg | qty. | |
| KFP | 10-65 | 0.73 | 2 | |

You Tube



Clamping elements for workbenches

Clamp on workbenches securely and variably



For all common workbenches
with a hole system



Tried and tested technology put back in the spotlight

As a specialist for manual clamping tools, BESSEY also provides solutions for fixing workpieces to workbenches. You can use the BESSEY TWV and TW clamping elements in conjunction with the TW16AW workbench adapter on any workbench with a hole system, such as the Sjöbergs workbench models. The tried and tested BESSEY all-steel clamp solutions were the inspiration for development. The unique BESSEY steel quality that is found in both the optimised profile shape and the spindle therefore guarantees you a dimensi-

onally stable and torsion-resistant tool. Tried and tested BESSEY handle variants are also available. Regardless of whether you're using the clamping elements with a variable (TWV) or a fixed throat depth (TW), both designs are available with a 2-component plastic handle, a tommy bar or a lever handle. It doesn't matter which clamping element you choose: each one can be integrated into your workbench without tools thanks to the adapter and can be placed in the exact correct position to fix your workpiece. You can really master drilling, planing or sanding jobs.

Clamping elements for workbenches

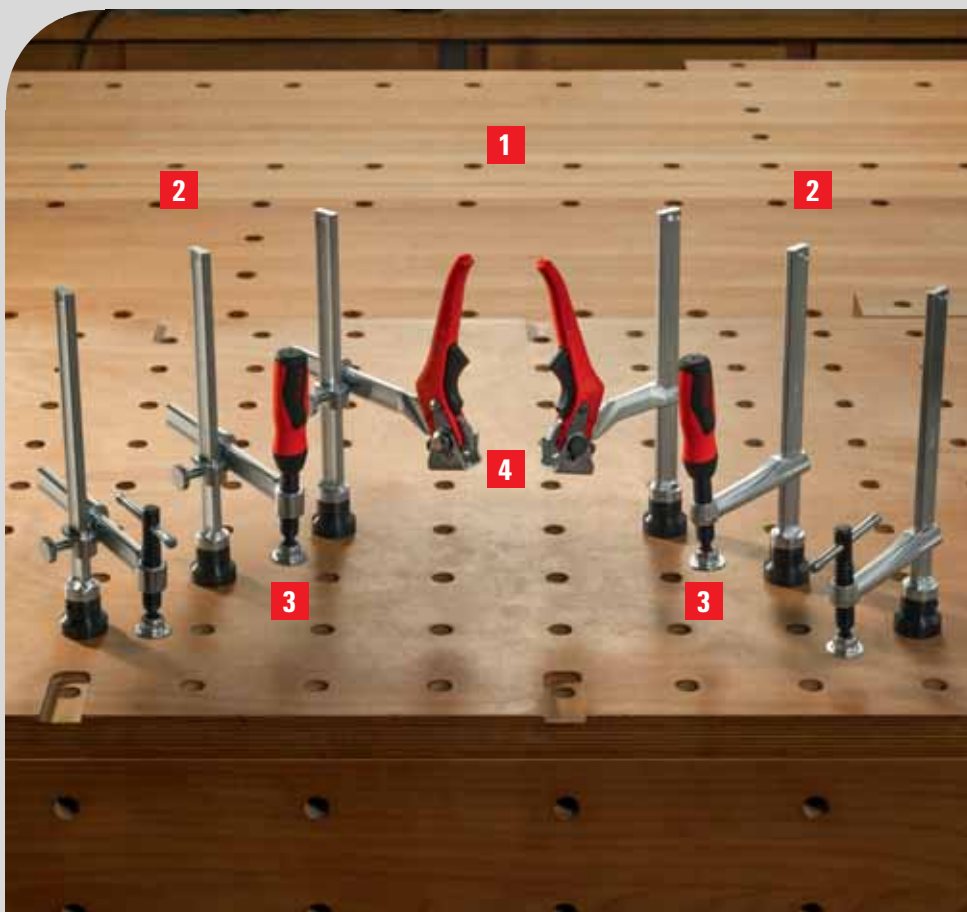

Your benefits at a glance:

1 Perfect addition

Thanks to the TW16AW adapter, BESSEY TWV and TW clamping elements with a 16 hole system can also be used on workbenches with a hole system.

2 Flexible or fixed throat depth

Both the clamping elements with an infinitely adjustable throat depth (TWV) and those with a fixed throat depth (TW) are available with three handle variants.

3 Smooth-running spindle

The surface-coated spindle with acme thread (both for the 2-component plastic handle and the tommy bar) runs particularly smoothly and does not jam.

4 Ratchet mechanism

The natural force of the lever is used in the lever handle version. The ratchet mechanism ensures rapid, controlled, vibration-free clamping. The wear-resistant cam guarantees a long service life.



- Accessories for BESSEY TWV and TW clamping elements with 16 hole system
- Suitable for all common workbenches with a hole system
- Can be used without tools
- The stud pin can be changed to use other hole systems

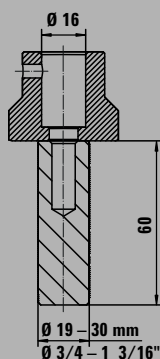

Workbench adapter TW16AW

| N ^o | ∅ | Suitable for | | kg | ∅ | V3 |
|----------------|----|--------------|--------|------|---|----|
| | | mm | " | | | |
| TW16AW19 | 16 | 19 | 3/4 | 0.33 | 1 | |
| TW16AW20 | 16 | 20 | 13/16 | 0.34 | 1 | |
| TW16AW22 | 16 | 22 | 7/8 | 0.35 | 1 | |
| TW16AW25 | 16 | 25,4 | 1 | 0.44 | 1 | |
| TW16AW30 | 16 | 30 | 1 3/16 | 0.52 | 1 | |



TW16AW22 / TW16AW25: While stocks last



Multi angle pad VAD (2 pcs./bag)

| N ^o | ∠ | Jaw face width | kg | ∅ | V3 |
|----------------|-----------------------------|----------------|------|---|----|
| | | mm | | | |
| VAD | from 60° inner to 60° outer | 45 | 0.48 | 1 | |

see catalogue page 57

Clamping elements for workbenches



Clamping element with variable throat depth TWV



| N ^o | ∅ | Clamping height | | <x> | ⚖ | 📦 | |
|----------------|----|-----------------|--------|----------|------|------|----|
| | mm | mm | mm | mm | kg | qty. | V3 |
| TWV16-20-15-2K | 16 | 200 | 30-150 | 22 x 8.5 | 1.12 | 1 | |
| TWV16-20-15K | 16 | 200 | 30-150 | 22 x 8.5 | 1.04 | 1 | |
| TWV16-20-15H | 16 | 200 | 60-150 | 22 x 8.5 | 1.21 | 1 | |



- TWV16: Clamping force up to 2,500 N, TWV28: Clamping force up to 5,500 N
- Precise, individual clamping
- Tempered profile and sliding arm for sprung and elastic clamping
- Infinitely adjustable throat depth (TWW)
- Various design versions:
 - High quality 2-component plastic handle and tommy bar with rounded ends – each with smooth-running trapezoidal threaded spindle and tool-free pressure plate replacement
- Lever handle with an indexing mechanism for controlled, fast and vibration-proof clamping



Clamping element with fixed throat depth TW



| N ^o | ∅ | Clamping height | | <x> | ⚖ | 📦 | |
|----------------|----|-----------------|-----|----------|------|------|----|
| | mm | mm | mm | mm | kg | qty. | V3 |
| TW16-20-10-2K | 16 | 200 | 100 | 22 x 8.5 | 0.93 | 1 | |
| TW16-20-10K | 16 | 200 | 100 | 22 x 8.5 | 0.86 | 1 | |
| TW16-20-10H | 16 | 200 | 100 | 22 x 8.5 | 1.01 | 1 | |

3D CAD data for download at www.bessey.de

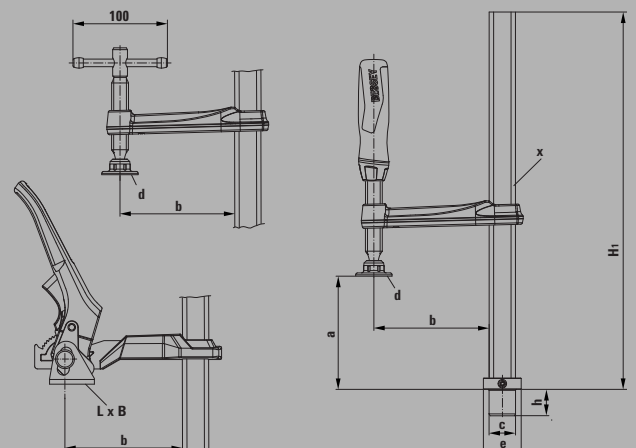
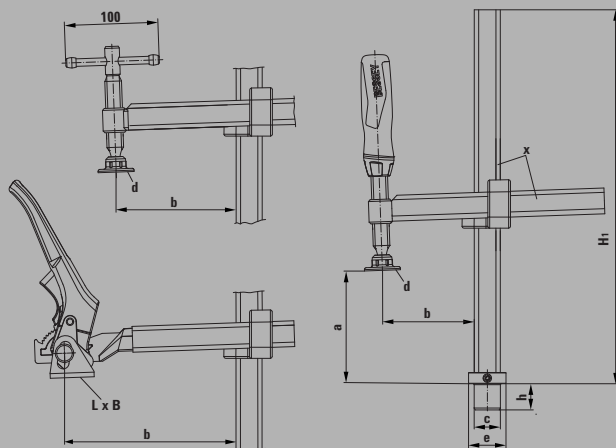

Table of dimensions

| | Bolt ∅ | Bolt height | Clamping height | Throat depth | Height of base | Pressure plate dimensions | | Foot „F“ | | Rail profile |
|----------------|--------|-------------|-----------------|--------------|----------------|---------------------------|-------|------------|-------------|--------------|
| | „c“ | „h“ | „a“ | „b“ | „H1“ | „L x B“ | ∅ „d“ | Foot ∅ „e“ | Foot height | mm |
| | mm | mm | mm | mm | mm | mm | mm | mm | mm | mm |
| TWV16-20-15-2K | 16 | 20.5 | 200 | 30-150 | 265 | – | 32 | 30 | 10 | 22 x 8.5 |
| TWV16-20-15K | 16 | 20.5 | 200 | 30-150 | 265 | – | 32 | 30 | 10 | 22 x 8.5 |
| TWV16-20-15H | 16 | 20.5 | 200 | 60-150 | 265 | 41 x 26 | – | 30 | 10 | 22 x 8.5 |
| TW16-20-10-2K | 16 | 20.5 | 200 | 100 | 265 | – | 32 | 30 | 10 | 22 x 8.5 |
| TW16-20-10K | 16 | 20.5 | 200 | 100 | 265 | – | 32 | 30 | 10 | 22 x 8.5 |
| TW16-20-10H | 16 | 20.5 | 200 | 100 | 265 | 41 x 26 | – | 30 | 10 | 22 x 8.5 |

Clamping elements for multifunction tables

NEW



Clamping element for multifunction tables TW-KLI



| N ^o | ∅ | <a> | | <x> | ⚖ | 📦 | |
|----------------|----|-----|-----|--------|-----|------|----|
| | mm | mm | mm | mm | kg | qty. | V3 |
| TW20-15-8-KLI | 20 | 150 | 80 | 20 x 5 | 0,3 | 1 | |



- Clamping force up to 500 N
- Use on multifunctional tables with a 20-hole system
- Stable sliding arm made of light magnesium for rapid, vibration-proof clamping
- Profile made of cold-drawn quality steel for flexible and elastic clamping



Toggle clamp systainer STC-S-MFT



| N ^o | Contents/pc. | ⚖ | 📦 | |
|----------------|--|------|------|----|
| | | kg | qty. | V3 |
| STC-S-MFT | 4 x horizontal toggle clamp STC-HH50 2 x push-pull toggle clamp STC-IHH25 6 x adapter STC-SET-T20 2 x all-steel table clamp GTR12 | 5.71 | 1 | |

- Multi-functional systainer for installation technicians
- With wood insert including 20 holes
- And 3 different clamping options

Clamping elements for multifunction tables



Adapter for multifunction tables STC-SET-T20

| N ^o | Contents/pc. | Suitable for | | | V3 |
|----------------|---|---|------|------|----|
| | | | kg | qty. | |
| STC-SET-T20 | 1 x Cylindrical screw DIN 912 M 8 x 35 1 x Lock pin D 20 x 17 1 x Knurled nut M 8 | STC-HH50 STC-HH70 STC-IHH25 STC-VH50 | 0.09 | 6 | |



- For using the BESSEY toggle clamps on multifunction tables such as Festool MFT and Sortimo WorkMo with hole diameter of 20 mm and plate thickness of min. 19 mm to max. 25 mm



STC accessory set for multifunction tables

| N ^o | Contents/pc. | ← a → | | | | | V3 |
|----------------|---------------------------------------|-------|----|-------|------|---|----|
| | | mm | mm | | | | |
| STC-HH50-T20 | 1 x STC-HH50 + 1 x STC-SET-T20 | 40 | 35 | 2,500 | 0.47 | 6 | |
| STC-HH70-T20 | 1 x STC-HH70 + 1 x STC-SET-T20 | 60 | 35 | 2,500 | 0.51 | 6 | |
| STC-IHH25-T20 | 1 x STC-IHH25 + 1 x STC-SET-T20 | 35 | 13 | 2,500 | 0.54 | 6 | |
| STC-VH50-T20 | 1 x STC-VH50 + 1 x STC-SET-T20 | 40 | 35 | 2,500 | 0.52 | 6 | |



- For using the BESSEY toggle clamps on multifunction tables such as Festool MFT and Sortimo WorkMo with hole diameter of 20 mm and plate thickness of min. 19 mm to max. 25 mm

Seaming tool

Clamping large sheets of smooth material



Your benefits at a glance:

- 1 Vacuum pumps with control function**
The required vacuum is generated with only a few movements of the pump – for a maximum vacuum and top clamping force up to 1,200 N. The status of the vacuum can be checked at any time via a marking ring on the pump tappet and brought back up to the maximum by repeated pumping.
- 2 Release button**
By simply pressing the release button, the vacuum disappears and the seaming tool can be removed quickly.
- 3 Quick adjusting screw**
To quickly adjust the distance, simply undo the screws and slide the suction cups into the desired position via the guide rails.
- 4 Sturdy construction**
The proven BESSEY all-steel rails, which run in anodised aluminium profiles, keep the suction discs on precisely the same level, even under high clamping pressures. This guarantees a precise finished result.



Seaming tool PS 130, big and strong

| N ^o | <a> mm | Width mm | Length mm | kg | qty. | V3 |
|----------------|-----------|-------------|--------------|------|------|----|
| PS130 | 5-130 | 215 | 715 | 4.08 | 1 | |



- For clamping and positioning large and potentially heavy components with a smooth surface, such as artificial stone, ceramic, granite, Corian®, plastic, sheet metal and glass
- Manual vacuum pumps for maximum suction power, and therefore a maximum level of horizontal clamping force up to 1,200 N
- Marking ring on the pump lever to permanently check for a reliable vacuum
- Practical quick adjustment function for rapid adjustment of the distance between the two suction cups

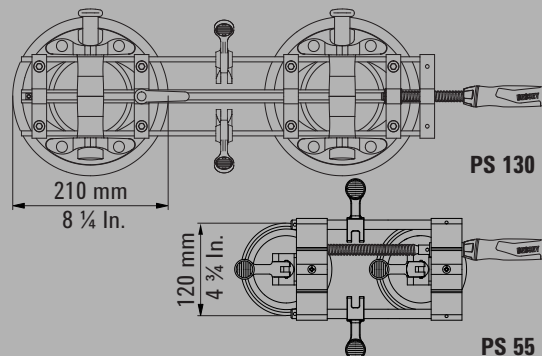

Corian® is a registered trademark of DuPont



Your benefits at a glance:

- 1 Gentle suction cups**
Easy to use. Engage the handle on the suction cups to generate a vacuum, and the seaming tool adheres automatically to the sheet.
- 2 Practical cam levers**
The two levers on the guide bars can be used to easily control the height differences which can occur when pulling together the sheets.
- 3 Sturdy construction**
Cold-drawn, electro-galvanised guide rods in sturdy aluminium profiles prevent the seaming tool from bending open during the clamping process and hold the seaming tool on one level. This guarantees a precise finished result.
- 4 Ergonomic plastic handle**
With the perfect handle, you can achieve up to 260 N of clamping force in the horizontal plane. This need is met by the high-quality two-component plastic handle with easy-to-move trapezoidal thread spindle.

You Tube



Seaming tool PS 55



| N ^o | <a> | Width | Length | kg | qty. | V3 |
|----------------|-------|-------|--------|------|------|----|
| | mm | mm | mm | | | |
| PS55 | 10-55 | 144 | 363 | 1.68 | 1 | |

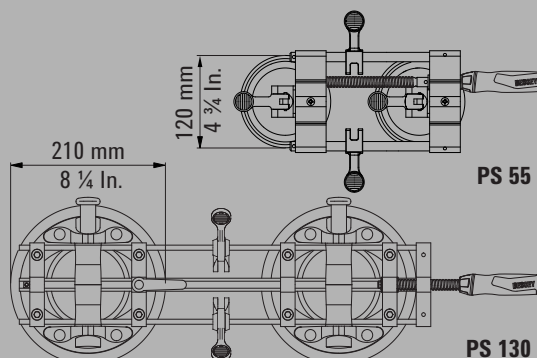

Corian® is a registered trademark of DuPont



- For clamping and positioning components with a smooth surface, such as ceramic, granite, Corian®, plastic, sheet metal and glass, which require low clamping forces (up to 260 N)
- Clamping levers on the suction cups ensure rapid handling
- Cam lever to compensate for differing heights at the joint

Assembling door frames



Systematic assembly

The modern technique of assembling door frames using assembly foam requires special tools that will ensure accurate alignment and support. With its TU door frame brace, BESSEY has developed a world-renowned assembly tool that satisfies these requirements. This, combined with the TUX extension, the TFM door frame straightening clamp and the WTR angle door frame straightening clamp, make up the perfect assembly system. For example, the TU and the TUX extension that can be combined

without tools also enable extra-wide doors to be installed, as required for barrier-free construction. The TFM door frame straightening clamp can be used to gently move frames that are fixed into the wall breakthrough, without wedging the trim lining gap or damaging wallpapered walls. Furthermore, the WTR angle door frame straightening clamp can be used to hold and align the horizontal and vertical door frames so that they are at an angle of exactly 90° to each other. As you can see, this enables and rationalises the process of fitting door frames noticeably.

The door frame clamp TU – easy to handle, and maintains the precise door frame dimensions.

You Tube



Door frame and window assembly tools



Door frame clamp TU



| N ^o | <a> | | | |
|----------------|----------|------|------|----|
| | mm | kg | qty. | V3 |
| TU | 565-1010 | 1.27 | 2 | |

Door frame clamp set TU-TRAGE



| N ^o | Contents/pc. | | | |
|----------------|---|------|------|----|
| | | kg | qty. | V3 |
| TU-TRAGE | 6 (3 sets) door frame clamps for a total of 3 doors | 9.78 | 1 | |

In a nylon wheeled case or safe and dustfree storage and for easy transport

Door frame brace extension TUX

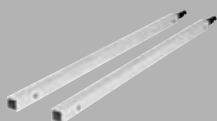

| N ^o | <a> | | | |
|----------------|-----------|------|------|----|
| | mm | kg | qty. | V3 |
| TUX | 1040-1960 | 0.37 | 1 | |

Contents: 2 extension rods

Door frame straightening clamp TFM



| N ^o | Adjusting range | | | | |
|----------------|-----------------|-----|------|------|----|
| | mm | mm | kg | qty. | V3 |
| TFM-2K | 35 | 70 | 0.58 | 2 | |

Angle door frame straightening clamp WTR



| N ^o | Opening chuck thickness | Adjusting range | | | |
|----------------|-------------------------|-----------------|------|------|----|
| | mm | mm | kg | qty. | V3 |
| WTR | 8-30 | 32 | 1.05 | 2 | |

- Gently and precisely braces and supports door casing during foam filling of wall joint
- Telescopic square anodised aluminium tubing with mm scale and adjusting screw for precision work
- Cross-shaped pressure plate with interchangeable clamping elements for frame depths of 6 to 13 cm or 13 to 30 cm
- Removable clamping bracket with increased clamping surfaces and removable brackets to insert the door frame securely and easily

- Accessories to increase the opening width of the TU door frame brace
- This enables extra-wide doors to be installed
- It can be used without tools in just a few steps

- For quick, precise aligning and fixing of door frames
- The intelligent companion for the BESSEY door frame clamp TU and TMS

- For neatly fixed and stabilised frame corners
- For mounting at a precise 90° angle

Door frame assembly tools

- "Gently and precisely" braces and supports door casing during foam filling of wall joint
- Telescopic round aluminium tube with adjusting screw for precision work
- With clamping elements on the clamping faces in order to secure struts in frames and to hold them at precise distances
- On carded hang pack



You Tube



Door frame assembly device TMS

| N ^o | <a> | | kg | qty. | V3 |
|----------------|----------|--|------|------|----|
| | mm | | | | |
| TMS | 560-1010 | | 0.68 | 2 | |



Window installation clamp FRK

| N ^o | Frame thicknesses | Adjusting range | kg | qty. | V3 |
|----------------|-------------------|-----------------|------|------|----|
| | mm | mm | | | |
| FRK85 | 40-85 | 30 | 0.43 | 4 | |



- Permits rapid, precise straightening and fixing of window frames



Pipe clamping set BPC

| N ^o | For pipes Ø | | | kg | qty. | V3 |
|----------------|-------------|-----|-----|------|------|----|
| | mm | " | | | | |
| BPC-H12 | 21.3 | 1/2 | 40 | 0.88 | 4 | |
| BPC-H34 | 26.9 | 3/4 | 42 | 1.30 | 4 | |



- Suitable for steel pipes DN 20/R3/4" or DN 15/R1/2"
- Outer diameter 26.9 mm or 21.3 mm
- Infinitely-adjustable clamping width
- With stand
- On carded hang pack

Mobile size presses



Sash clamps TAN with I-profile 80 x 42 x 3.9 mm



| N ^o | <a> | Jaw dimensions w x h | | | V3 |
|----------------|------|-------------------------|-------|---|----|
| | mm | | | | |
| TAN120 | 1200 | 80 x 80 | 10.10 | 1 | |
| TAN150 | 1500 | 80 x 80 | 12.20 | 1 | |
| TAN210 | 2100 | 80 x 80 | 15.00 | 1 | |
| TAN250 | 2500 | 80 x 80 | 17.50 | 1 | |

- Clamping force up to 24,000 N
- Easily adjustable pressure plates
- Removable crank handle
- Very sturdy thanks to I-profile



Sash clamps TB with T-profile 40 x 40 x 5 mm

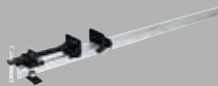

| N ^o | <a> | Jaw dimensions w x h | | | V3 |
|----------------|------|-------------------------|------|---|----|
| | mm | | | | |
| TB100 | 1000 | 66 x 43 | 5.07 | 1 | |
| TB120 | 1200 | 66 x 43 | 5.54 | 1 | |
| TB150 | 1500 | 66 x 43 | 6.03 | 1 | |
| TB210 | 2100 | 66 x 43 | 7.87 | 1 | |
| TB250 | 2500 | 66 x 43 | 9.43 | 1 | |



- Clamping force up to 14,000 N
- With attached locking bolt
- Tommy bar
- Sturdy thanks to T-profile



Sash clamps TL, light with I-profile 37 x 11 x 4.5 mm



| N ^o | <a> | Jaw dimensions w x h | | | V3 |
|----------------|------|-------------------------|------|---|----|
| | mm | | | | |
| TL60 | 600 | 48 x 53 | 3.80 | 2 | |
| TL90 | 900 | 48 x 53 | 4.30 | 2 | |
| TL120 | 1200 | 48 x 53 | 5.00 | 2 | |
| TL180 | 1800 | 48 x 53 | 6.30 | 2 | |



- Clamping force up to 9,900 N
- Easily adjustable pressure plates
- Crank handle
- Very sturdy thanks to I-profile

Special flooring tools

For laying parquet, laminated and panel flooring



Simple and efficient

Floor coverings such as wood and cork parquet, laminated and panel flooring are stylish and fashionable. BESSEY has developed a range of specialist clamping tools that make the laying of these sought

after floor coverings easier and more efficient. Examples of BESSEY innovations are spacer PVA and the flooring and clamping system SVH. That makes BESSEY a trendsetter in this field as well!

You Tube



Special flooring tools



Spacer AV2 (4 pcs./bag)

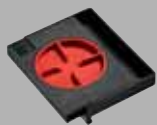

| N ^o | ← a → | | Adjusting range | | | V3 |
|----------------|-------|----|-----------------|------|------|----|
| | mm | mm | mm | kg | qty. | |
| AV2 | 20 | 89 | 5-20 | 0.22 | 12 | |

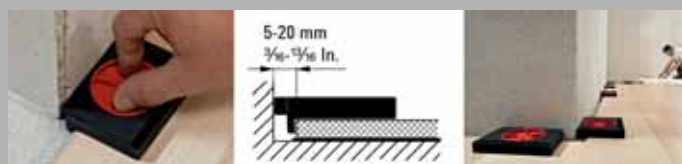

The spacer will be delivered in an attractive sales presenter. Available only in full pack quantities.

Spacer PVA



| N ^o | ← a → | | Adjusting range | | | V3 |
|----------------|-------|-----|-----------------|------|------|----|
| | mm | mm | mm | kg | qty. | |
| PVA | 35 | 130 | 7-35 | 0.48 | 6 | |

Flooring and clamping system SVH/SVG



| N ^o | ← a → | Band w x d | Tear proof | | | V3 |
|----------------|-------|------------|------------|------|------|----|
| | mm | mm | N | kg | qty. | |
| SVH400 | 4000 | 25 x 1 | 5000 | 0.75 | 1 | |
| SVH760 | 7600 | 25 x 1 | 5000 | 0.77 | 1 | |
| SVG | 4000 | 25 x 1 | 2500 | 0.69 | 1 | |

Additional use: can be used as lashing straps

- Quickly and infinitely adjustable for wall distances of 5 to 20 mm
- Spacer for floating laminate and parquet flooring installations
- Wide contact and support area for avoiding pressure points on the floorboards and plaster
- Easy to remove by simply turning back
- Very light and compact

- Infinitely adjustable for wall distances of 7 to 35 mm
- Front and lateral support when gluing solid wood floorings
- Pull-down function dependent on the inclined angle of the spindle, with movable mounted pressure plate with protective cap
- Extra wide contact area of 130 mm prevents edge damage to the floorboards

- For laying parquet, laminated and panel flooring
- SVH with spacer and band of high-strength polyester
- SVH 400 and SVG – on carded hang pack

Telescopic drywall supports

All firmly in position



Highly versatile in use!

BESSEY satisfies every requirement with its **ST** and **STE** ceiling and mounting supports. Besides the fixation of a wide variety of building materials, they can also be used for room partitioning, as simple burglary protection, for affixing cat nets

and even for the construction of winter gardens or carports. But that's not all. Practical accessories offer even more possibilities for the supports. This is because a wider support plate increases the contact area and a multifunctional holder allows the use of lasers, construction lights and cameras, for example.

Secure hold

Resilient and anti-slip, the support guarantees secure holding, even on sensitive surfaces:

- due to special steel pipes ensures a max load of 150 kg can be applied (dependent upon the size of support and length applied)
- due to additional locking of the release button
- due to rubber PVC contact surfaces top and bottom



Easy to handle

The support can be used quickly:

- due to the fixing in just two steps: The rough pre-setting is carried out using the telescoping and quickly locking inner pipe; the final clamping is carried out by turning the support at the foam grip



You Tube



Telescopic drywall support ST

| No | Adjusting range mm | Load limit at | | kg | qty. | V3 |
|-------|-----------------------|-----------------------------|-----------------------------|------|------|----|
| | | min. extension length kg | max. extension length kg | | | |
| ST125 | 750-1250 | 150 | 60 | 1.41 | 2 | |
| ST250 | 1450-2500 | 150 | 60 | 2.06 | 2 | |
| ST290 | 1600-2900 | 150 | 50 | 2.24 | 2 | |

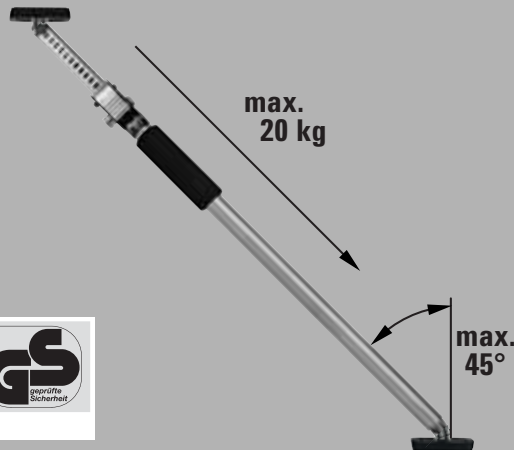

- Resilient up to a maximum of 150 kg when the telescopic rod is fully retracted
- Stable construction due to special steel pipes and anti-slip PVC contact surfaces (8,5 x 6,5 cm)
- Application also on slopes due to continuously swivelable contact surfaces of -45° to +45°
- Easy, safe handling due to a telescoping and locking inner pipe as well as an outer pipe that can be turned by the foam grip
- GS-certified for quality and safety

Sales display ST18-D see catalogue page 132

Telescopic drywall supports

Extremely secure hold

The support guarantees a reliable and secure hold:

- due to robust design ensures a max load of 350 kg can be applied (dependent upon the size of support and length applied)
- due to rubber PVC contact surfaces top and bottom
- due to anti-slip system integrated in the grip



Quick and accurate handling

The support can be precisely set to requirements, and safely released:

- due to fixing in three steps: In order to pre-set the telescopic drywall support press the release button and extend the telescopic inner tube to the desired length. Fine adjustment takes place by pressing the pump lever until the system plate of the support lies against the work-piece. Then turn the grip clockwise until the desired holding force is attained (observe the max. load-bearing capacity)
- due to releasing in two steps: First turn the telescopic drywall support anti-clockwise. As soon as no further holding force is present, press the release button to retract the inner tube.

You Tube



- Resilient up to a maximum of 350 kg when the telescopic rod is fully retracted
- Extremely stable construction due to highly durable steel pipes and non-slip PVC contact surfaces (9 x 7 cm)
- Single-handed operation thanks to 2-component plastic handle with pump mechanism
- Quick-slide button for rapid extension and retraction of the telescopic bar
- Controllable holding force by turning the support on the grip
- Application also on slopes due to continuously swivelling contact surfaces from -45° to +45°
- GS-certified for quality and safety

Telescopic drywall support STE with pump grip



NEW

| No | Adjusting range mm | Load limit at | | kg | qty. | V3 |
|--------|-----------------------|-----------------------------|-----------------------------|------|------|----|
| | | min. extension length kg | max. extension length kg | | | |
| STE250 | 1450-2500 | 350 | 160 | 3.30 | 2 | |
| STE300 | 1700-3000 | 350 | 110 | 3.80 | 2 | |
| STE370 | 2070-3700 | 350 | 65 | 4.50 | 2 | |



NO. Z1A 111445 0001

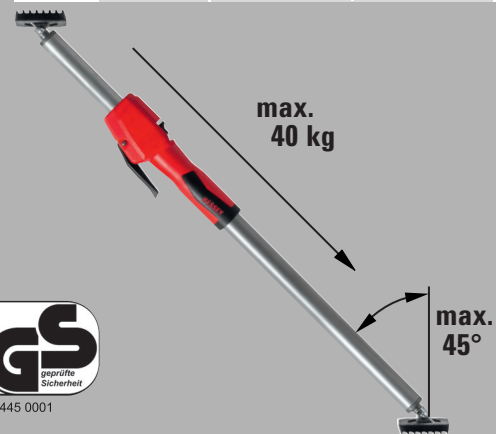

Sales display ST18-D see catalogue page 132

Telescopic drywall supports



NEW

Multi-function/laser fixture STE-LH



| N ^o | Length | Width | Height | | | V3 |
|----------------|--------|-------|--------|------|------|----|
| | mm | mm | mm | kg | qty. | |
| STE-LH | 200 | 140 | 60 | 0.25 | 1 | |



- Accessory with 1/4" thread for holding a laser, camera etc
- Can be used without tools on round (0-45 mm) and angular (0-55 mm) support parts such as ceiling and assembly supports, profiles, ladders
- L-shaped rotating fixture with 2 rotation axes: 360° next to fixing clamp, 180° at threaded connection
- On carded hang pack

NEW

Support plate STE-SP35



| N ^o | Length | Width | Height | | | V3 |
|----------------|--------|-------|--------|------|------|----|
| | mm | mm | mm | kg | qty. | |
| STE-SP35 | 355 | 80 | 22 | 0.60 | 1 | |



- Light aluminium profile with non-slip cellular rubber
- For increasing the support surface of BESSEY ceiling and assembly supports ST (only in conjunction with replacement contact surface 3101952) and STE
- Secure fastening onto the contact surfaces thanks to star grip screws
- On carded hang pack

NEW

Replacement contact surface



| N ^o | Suitable for | Length | Width | Height | | | V3 |
|----------------|--------------|--------|-------|--------|------|------|----|
| | | mm | mm | mm | kg | qty. | |
| 3101952 | ST, STE | 90 | 70 | 10 | 0.15 | 1 | |

POS Presentation

- For equipping with 18 roof and assembly supports ST or STE
- Professional sales display in solid steel design
- The display can be refilled at any time
- Space-saving format: approx. 50 x 40.3 x 100 cm



Telescopic drywall support sales display ST18-D

| N ^o | Description |  | |
|----------------|--|---|----|
| | | kg | V3 |
| ST18-D | * Please inquire directly at BESSEY for suggestions of placement | 4.80 | |

- Specially developed for sales and demonstration purposes
- Dimensions: 50 x 60 x 146 cm
- With label and label holder
- Please inquire directly at BESSEY for suggestions of placement



Demonstration trolley VFW, unstocked

| N ^o |  | |
|----------------|---|----|
| | kg | V3 |
| VFW | 28.33 | |

While stocks last



POS Presentations

We will gladly provide you with various range and presentation recommendations on request. Simply tell us about your customers – and we will tell you which product presentation suitable and which presentation materials, such as tool hooks, labels and mounting rails you require. For all-round professional product presentation and an effective boost for your sales. Just ask us!

Clamp trolley ZW 1



| N ^o | Layout |  | |
|----------------|---|---|----|
| | | kg | V3 |
| ZW1 | unstocked | 15.00 | |
| | | kg | V2 |
| ZW1-A01 | All-steel screw clamps 5 x GZ12, 5 x GZ16, 5 x GZ20, 5 x GZ25, 5 x GZ30, 3 x GZ40, 2 x GZ50, 2 x GZ60, 1 x GH16, 1 x GH20 | 57.00 | |
| ZW1-A01-2K | All-steel screw clamps 2K 5 x GZ12-2K, 5 x GZ16-2K, 5 x GZ20-2K, 5 x GZ25-2K, 5 x GZ30-2K, 3 x GZ40-2K, 2 x GZ50-2K, 2 x GZ60-2K, 1 x GH16, 1 x GH20 | 57.00 | |
| | | kg | V1 |
| ZW1-A99-2K | Malleable cast iron screw clamps 2K 5 x TG12-2K, 5 x TG16-2K, 5 x TG20-2K, 5 x TG25-2K, 5 x TG30-2K, 3 x TG40-2K, 2 x TGK50-2K, 2 x TGK60-2K, 1 x GZ16-2K, 1 x GZ20-2K | 65.00 | |

- Stable metal construction on castors
- Dimensions 50 x 60 x 146 cm
- Holds up to 90 clamps
- Malleable cast iron-, all-steel- and lever clamps with clamping ranges between 120 and 600 mm
- With label and label holder
- Suitable as sales aid and for the workshop area

Clamp trolley ZW 2



| N ^o | Layout |  | |
|----------------|--|---|----|
| | | kg | V3 |
| ZW2 | unstocked | 33.00 | |
| | | kg | V1 |
| ZW2-A99 | Malleable cast iron screw clamps 10 x TG20, 10 x TG25, 5 x TG30, 5 x TG40, 5 x TGK60, 3 x TGK80, 2 x TGK100, 2 x TGK125, 2 x TGK150, 2 x TGK200, 2 x GZ20, 2 x GZ25 | 154.30 | |
| ZW2-A99-2K | Malleable cast iron screw clamps 2K 10 x TG20-2K, 10 x TG25-2K, 5 x TG30-2K, 5 x TG40-2K, 5 x TGK60-2K, 3 x TGK80-2K, 2 x TGK100-2K, 2 x TGK125-2K, 2 x TGK150-2K, 2 x TGK200-2K, 2 x GZ20-2K, 2 x GZ25-2K | 154.30 | |

- Stable metal construction on castors
- Dimensions 100 x 60 x 153 cm
- Holds up to 120 clamps, it even holds long screw clamps
- Malleable cast iron and all-steel with clamping ranges between 200 and 2000 mm
- With label and label holder
- Suitable as sales aid and for the workshop area

BESSEY Cutting Technology

Product range 2021/2022



Technological edge thanks to the most innovative ideas and highest quality

You can find all information regarding cutting in the subsequent pages in a structured and lucid manner.

From handsnips with leverage to special tools for sheet metal work – and plumbing. And you will observe that BESSEY always offers you the best solution for all your tasks and applications. Enjoy browsing through!

Erdi



Lexicon

1. Types

Standard tin snips

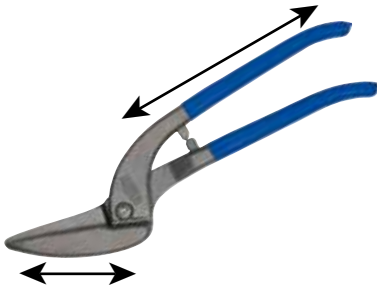

In standard tin snips, edges and handle are traditionally forged into one unit. The force required for cutting is determined by the ratio of edge length to the handle length.

Compound leverage snips



Compound leverage snips comprise a cutter head and a handle. The compound action produces additional leverage.

2. Models

Shape and straight cutting snips

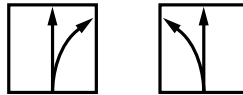

Shape and straight cutting snips are real "all-rounders". They can cut through a metal sheet (straight-cut) as well as cut large and small contours or radii (outlinecut). In this case, it does not matter whether you are cutting at the edge (edge cut) or at the centre of a sheet. You can naturally use shape and straight cutting snips for notching-operations.

Shape cutting snips

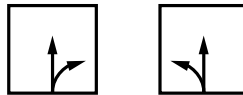

Shape cutting snips are best suited when you want fine and narrow radius cuts near the edges of a metal sheet. You can use the delicately shaped edge of these snips to cut extremely narrow shapes or curves without any problem.

Straight cutting snips



Do you wish to cut a metal sheet at the centre and/or near the edges? Then the perfect tool for you is the straight cutting snips. You can use long edges of this tool to cross-cut and notch large metal sheets quickly and precisely with less effort.

3. Right cutting or left cutting snips. What is the difference?



Left cutting snips

Right cutting snips

Right cutting snips are sharpened and designed so that they can cut right radii (i. e. a curve **from left to right**) easily. Left cutting snips are the best for radius cuts **from right to left**.

The common perception is that, right cutting snips are for right-handers, and left cutting snips for left-handers. This is not true. In fact, it is the other way round. If you, a right-hander, are cutting a radius (see above, **from left to right**), using right cutting snips, you have to cut outwards from your wrist. With left cutting snips, (radius is then **from right to left**) you can cut inwards from your wrist. This is considerably more ergonomic. Try it out once!

4. Grades

The service life of edges depends directly on the grades of steel used and processing. High-performance snips with case-hardened HSS-edges particularly fulfill the most stringent requirements regarding the service life and consistent cutting performance. Cutter heads of the HSS-TiN grade are additionally coated with extremely hard titanium nitride that reduces wear and tear. Other cutting materials, namely special high quality steel, high quality steel and standard quality steel, are available depending on the application and the frequency of use.

| Quality of steel | min. hardness Rockwell C | Durability |
|------------------------|--------------------------|------------|
| HSS-TiN | 65 | +++++ |
| HSS | 65 | ++++ |
| Special high quality | 61 | +++ |
| High quality steel | 59 | ++ |
| Standard quality steel | 56 | + |

The high quality of the steel at the cutting edge leads to a much longer service life of the snips.

| Quality of steel | For maximum sheet thickness at the tensile strength of: | | | |
|--|---|-----------------------|-----------------------|------------------------|
| | 400 N/mm ² | 600 N/mm ² | 800 N/mm ² | 1100 N/mm ² |
| Normal metal snips | | | | |
| HSS D407..; D416..; D418..; | 1,2 mm | 1,0 mm | 0,8 mm | 0,6 mm |
| High quality steel D202..; D206..; D207..; D208..; D214..; D216..; D218..; | 1,2 mm | 1,0 mm | 0,8 mm | / |
| Standard quality steel D102..; D106..; D107..; D114..; D116..; D118..; D146..; D159..; D70..-D77..; D122N; D122A | 1,2 mm | 1,0 mm | 0,8 mm | / |

| Quality of steel | For maximum sheet thickness at the tensile strength of: | | | |
|--|---|----------------------------|----------------------------|------------------------|
| | 400 N/mm ² | 600 N/mm ² | 800 N/mm ² | 1100 N/mm ² |
| Hand snips with leverage | | | | |
| HSS-TiN D27AH-TiN* | 1,5 mm | 1,2 mm | 1,0 mm | 0,8 mm |
| HSS D27AH* | 1,5 mm | 1,2 mm | 1,0 mm | 0,8 mm |
| Special high quality steel D17ASS D29SS*; D29ASS*; D29BSS*; D39ASS* D15A | 2,0 mm 1,5 mm 1,2 mm | 1,5 mm 1,2 mm 1,0 mm | 1,2 mm 1,0 mm 0,8 mm | / |
| High quality steel D08..; D16..; D17A; D22A D27*; D27A*; D27B* | 1,5 mm | 1,2 mm | 1,0 mm | / |

* Snips can be stressed for up to 3 x 0.6 mm (1.8 mm) for a short period of time for cutting the seams.

Caution! Manual sheet metal snips may only be used to cut thin sheets of soft metals and steel. They are not suitable for cutting through round or rectangular section metal shapes such as wires for example.

| Pictograms | Meaning |
|---|--|
|  | Tool suitable for persons from the age of 15 years |
|  | Do not use as a lever tool |
|  | Do not use as a hammer or pliers |
|  | Do not cut live cables/wires |
|  | Not suitable for cutting wire |
|  | Wear safety goggles |
|  | Wear gloves |
|  | The cutter head screwed connection can be readjusted with an open-end wrench |
|  | Maximum wire diameter |
|  | For cutting cardboard |
|  | For cutting leather |
|  | For cutting small plants |

Compound leverage snips

Higher quality work with less effort



Utilize the power of a compound lever!

Drop-forged cutter heads are always tempered and the edges double hardened! This produces high durability and burr-free cuts. Ergonomic handle has

standard plastic coating and an anti-slip protection. Both parts are joined in such a manner that it provides additional leverage. You can do the same work quicker with much less effort. Less worker fatigue = improved production! Try it out!

Shape and straight cutting snips D39ASS and D29ASS-2 – ideal for continuous, straight and curved cuts.

The Multisnip Longstyle D22A – with angled cutter head for greater safety.



The latest generation of leverage snips

Robust technology and an ergonomic design



Our know-how provides you with added value

The futuristic design of the latest generation of Erdi manual sheet metal snips is the first thing that catches the eye. But there's much more inside: technical refinements with maximum user benefits. The newly-developed D39ASS shape and straight cutting snips is comfortable to hold and easy to use. In order to obtain these ergonomic benefits, the handle opening range was reduced without sacrificing the cutting length, the latch was positioned in the centre and the cutter head was designed to be

more compact. The D39ASS also sets new standards when it comes to robustness. Friction in the joint area is prevented thanks to the sintered steel insert. The joint area is screwed tight using a stud bolt. You can see how all sorts of know-how from the BESSEY developers is packed into the latest generation of Erdi manual sheet metal snips. The result: an innovative cutting tool that meets BESSEY's quality requirements and therefore serves you well for a long time and makes working easier. Try it out for yourself!

Low-fatigue continuous cutting

Frictionless robust

The shape and straight cutting snips D39ASS are particularly smooth running and extremely wear-resistant:

- due to sintered steel insert in the joint area
- due to permanent threaded connection of the joint area with stable stud bolt
- due to stainless steel panel over the joint for protecting the spring beneath



Effort-saving

It is possible to use the complete cutting length with every cut:

- due to a significantly reduced handle opening angle

Easy to use

Right and left-handed users can lock and unlock the snips with ease, without a change in grip.

- due to central positioning of the latch on the top handle



Perfect cornering

They enable high-precision cutting of curves in the tightest of radii and, with less risk of scratching the surface:

- due to extremely compact cutter head with partially sunken threaded head connection



YouTube



Shape and straight cutting snips



| No | <a> | | | | ↓ max. ↑ | ⚙️ | ⚖️ | 📦 | V4 |
|------------|-----|---|-----|--------|----------------|-----|------|---|----|
| | mm | " | mm | " | | | | | |
| D39ASS | 230 | 9 | 30 | 1 3/16 | 1,2 | +++ | 0.49 | 5 | |
| D39ASSL | 230 | 9 | 30 | 1 3/16 | 1,2 | +++ | 0.49 | 5 | |
| D39ASS-SB | 230 | 9 | 30 | 1 3/16 | 1,2 | +++ | 0.50 | 5 | |
| D39ASSL-SB | 230 | 9 | 30 | 1 3/16 | 1,2 | +++ | 0.50 | 5 | |



- For continuous, straight and curved cuts
- Extremely compact cutter head with a partially countersunk head screw connection for increased manoeuvrability and precision for curved cuts
- Joint area screwed connection with stud bolt, sintered disc and maintenance-free spring for extreme robustness
- Reduced handle opening angle for optimised handling and an even cutting length
- Central latch for easy operation without having to change your grip
- Available in right or left cutting versions

Compound leverage snips



- ERGO-handle for increased comfort – reduced hand fatigue!
- For continuous, straight and curved cuts
- Compact cutter head: High manoeuvrability for shape cutting
- Optimised leverage ratio: 25 % less effort
- Optimised edge shape: No slipping even without serrations
- Available in right or left cutting versions



Shape and straight cutting snips

| N ^o | <a> | | | | ↓ max. mm | ⚙️ | ⚖️ | 📦 | V4 |
|----------------|---|--------|-----|--------|-----------------|-----|------|---|----|
| | mm | " | mm | " | | | | | |
| D29ASS-2 | 260 | 10 1/4 | 33 | 1 5/16 | 1,2 | +++ | 0.51 | 5 | |
| D29ASSL-2 | 260 | 10 1/4 | 33 | 1 5/16 | 1,2 | +++ | 0.51 | 5 | |
| D29ASS-2-SB | 260 | 10 1/4 | 33 | 1 5/16 | 1,2 | +++ | 0.51 | 5 | |
| D29ASSL-2-SB | 260 | 10 1/4 | 33 | 1 5/16 | 1,2 | +++ | 0.51 | 5 | |
| N ^o | Layout | | | | | | | 📦 | V4 |
| DSET29-15 | 1 x D29ASS-2, 1 x D29ASSL-2 and 1 x D15A in snips pouch | | | | | | | 1 | |



- ERGO-handle for increased comfort – reduced hand fatigue!
- For short, straight and curved cuts
- Edges with micro-serrations for slip-proof working
- Available in right or left cutting versions

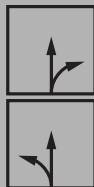

Shape cutting snips

| N ^o | <a> | | | | ↓ max. mm | ⚙️ | ⚖️ | 📦 | V4 |
|----------------|-----|--------|-----|--------|-----------------|-----|------|---|----|
| | mm | " | mm | " | | | | | |
| D29SS-2 | 260 | 10 1/4 | 40 | 1 9/16 | 1,2 | +++ | 0.49 | 5 | |
| D29SSL-2 | 260 | 10 1/4 | 40 | 1 9/16 | 1,2 | +++ | 0.49 | 5 | |



- ERGO-handle for increased comfort – reduced hand fatigue!
- For continuous, straight cuts
- Edges with micro-serrations for slip-proof working
- Available in right or left cutting versions



Straight cutting snips

| N ^o | <a> | | | | ↓ max. mm | ⚙️ | ⚖️ | 📦 | V4 |
|----------------|-----|--------|-----|--------|-----------------|-----|------|---|----|
| | mm | " | mm | " | | | | | |
| D29BSS-2 | 260 | 10 1/4 | 33 | 1 5/16 | 1,2 | +++ | 0.52 | 5 | |
| D29BSSL-2 | 260 | 10 1/4 | 33 | 1 5/16 | 1,2 | +++ | 0.52 | 5 | |



Shape and straight cutting snips



| N ^o | ←a→ | | ←b→ | | ↓ ↑ max. | ⚙ | ⚖ | 📦 | V4 |
|----------------|-----|--------|-----|--------|----------------|----|------|---|----|
| | mm | " | mm | " | | | | | |
| D27A | 260 | 10 1/4 | 33 | 1 5/16 | 1,2 | ++ | 0.56 | 5 | |
| D27AL | 260 | 10 1/4 | 33 | 1 5/16 | 1,2 | ++ | 0.56 | 5 | |
| D27A-SB | 260 | 10 1/4 | 33 | 1 5/16 | 1,2 | ++ | 0.57 | 5 | |
| D27AL-SB | 260 | 10 1/4 | 33 | 1 5/16 | 1,2 | ++ | 0.57 | 5 | |



- For continuous, straight and curved cuts
- Edges with micro-serrations for slip-proof working
- Available in right or left cutting versions

Shape cutting snips



| N ^o | ←a→ | | ←b→ | | ↓ ↑ max. | ⚙ | ⚖ | 📦 | V4 |
|----------------|-----|--------|-----|--------|----------------|----|------|---|----|
| | mm | " | mm | " | | | | | |
| D27 | 260 | 10 1/4 | 40 | 1 9/16 | 1,2 | ++ | 0.49 | 5 | |
| D27L | 260 | 10 1/4 | 40 | 1 9/16 | 1,2 | ++ | 0.49 | 5 | |



- For short, straight and curved cuts
- Edges with micro-serrations for slip-proof working
- Available in right or left cutting versions

Straight cutting snips



| N ^o | ←a→ | | ←b→ | | ↓ ↑ max. | ⚙ | ⚖ | 📦 | V4 |
|----------------|-----|--------|-----|--------|----------------|----|------|---|----|
| | mm | " | mm | " | | | | | |
| D27B | 260 | 10 1/4 | 32 | 1 5/16 | 1,2 | ++ | 0.56 | 5 | |
| D27BL | 260 | 10 1/4 | 32 | 1 5/16 | 1,2 | ++ | 0.56 | 5 | |



- For continuous, straight cuts
- Edges with micro-serrations for slip-proof working
- Available in right or left cutting versions

Compound leverage snips

Shape and straight cutting snips, robust

- For continuous, straight and curved cuts
- Edges with micro-serrations for slip-proof working
- Exceptionally robust: Drop-forged handles
- Painted handles
- Available in right or left cutting versions



| N ^o | <a> | | | | ↓ max. ↑ | ⌚ | ⚖ | 📦 | V4 |
|----------------|-----|-------|-----|---|----------------|-----|------|---|----|
| | mm | " | mm | " | | | | | |
| D17ASS | 240 | 9 1/2 | 24 | 1 | 1,5 | +++ | 0.55 | 5 | |
| D17ASSL | 240 | 9 1/2 | 24 | 1 | 1,5 | +++ | 0.55 | 5 | |
| D17A | 240 | 9 1/2 | 24 | 1 | 1,2 | ++ | 0.55 | 5 | |
| D17AL | 240 | 9 1/2 | 24 | 1 | 1,2 | ++ | 0.55 | 5 | |



Shape and straight cutting snips, manoeuvrable



- Special flat cutter head enables cutting in narrowest radius
- For continuous, straight and curved cuts
- Edges with micro-serrations for slip-proof working
- Available in right or left cutting versions



| N ^o | <a> | | | | ↓ max. ↑ | ⌚ | ⚖ | 📦 | V4 |
|----------------|-----|---|-----|--------|----------------|----|------|---|----|
| | mm | " | mm | " | | | | | |
| D08 | 230 | 9 | 27 | 1 1/16 | 1,2 | ++ | 0.38 | 5 | |
| D08L | 230 | 9 | 27 | 1 1/16 | 1,2 | ++ | 0.38 | 5 | |
| D08-SB | 230 | 9 | 27 | 1 1/16 | 1,2 | ++ | 0.39 | 5 | |
| D08L-SB | 230 | 9 | 27 | 1 1/16 | 1,2 | ++ | 0.39 | 5 | |



Shape and straight cutting snips MULTISNIP Longstyle

- For long continuous straight and large radius cuts
- Extra long cutting blades, laterally displaced for continuous cuts
- Available only in left cutting version



| N ^o | <a> | | | | ↓ max. ↑ | ⌚ | ⚖ | 📦 | V4 |
|----------------|-----|----|-----|-------|----------------|----|------|---|----|
| | mm | " | mm | " | | | | | |
| D22A | 280 | 11 | 64 | 2 1/2 | 1,2 | ++ | 0.43 | 5 | |
| D22A-SB | 280 | 11 | 64 | 2 1/2 | 1,2 | ++ | 0.45 | 5 | |



Aviation snips



| N ^o | <a> | | | | ↓ max. ↑ | ⚙️ | ⚖️ | 📦 | V4 |
|----------------|-----|-------|-----|--------|----------------|----|------|----|----|
| | mm | " | mm | " | | | | | |
| D16 | 240 | 9 1/2 | 40 | 1 9/16 | 1,2 | ++ | 0.38 | 10 | |
| D16-SB | 240 | 9 1/2 | 40 | 1 9/16 | 1,2 | ++ | 0.39 | 10 | |



- For short, straight and curved cuts
- Edges with micro-serrations for slip-proof working
- Left cut model available as well

Aviation snips



| N ^o | <a> | | | | ↓ max. ↑ | ⚙️ | ⚖️ | 📦 | V4 |
|----------------|-----|-------|-----|--------|----------------|----|------|----|----|
| | mm | " | mm | " | | | | | |
| D16L | 240 | 9 1/2 | 40 | 1 9/16 | 1,2 | ++ | 0.38 | 10 | |
| D16L-SB | 240 | 9 1/2 | 40 | 1 9/16 | 1,2 | ++ | 0.39 | 10 | |



- For short, straight and curved cuts
- Edges with micro-serrations for slip-proof working
- Right cut model available as well

Aviation snips



| N ^o | <a> | | | | ↓ max. ↑ | ⚙️ | ⚖️ | 📦 | V4 |
|----------------|---|-------|-----|-------|----------------|----|------|----|----|
| | mm | " | mm | " | | | | | |
| D16S | 240 | 9 1/2 | 44 | 1 3/4 | 1,2 | ++ | 0.38 | 10 | |
| D16S-SB | 240 | 9 1/2 | 44 | 1 3/4 | 1,2 | ++ | 0.39 | 10 | |
| N ^o | Layout | | | | | | | 📦 | V4 |
| DSET16 | 1 x D16, 1 x D16L and 1 x D16S in snips pouch | | | | | | | 1 | |
| D16S-D | 12 x D16S in sales presenter | | | | | | | 1 | |



- No offset to blades, for short, straight and curved cuts with a large radius in both left and right directions
- Edges with micro-serrations for slip-proof working
- Available only in left cutting version

All-round snips

Compact in design, big in performance



Power through design

The newly developed BESSEY small format aviation snips will win over customers with their performance. These Ideal snips offer compound leverage in a uniquely compact construction. The extremely small forged heads have optimized blade geometry

and fine-tuned cutting leverage and, in a much smaller overall length. The new D15A is small and manoeuvrable; perfect for cutting small radii and in confined spaces but with the strength of a full-sized aviation snip. A multi-purpose tool that will fit well in a pocket, a tool pouch or most especially the tool box.

The Ideal snips D15A – small, strong, manoeuvrable and always ready-to-hand.



Your benefits at a glance:

- 1 Extremely compact cutting head**
The design of the uniquely compact design head offers one tremendous manoeuvrability, the ability to cut the narrowest radii and the ability to reach some of the most difficult to access spots.
- 2 Practicable combination of bar and arrester**
A practical locking mechanism allows one to open and close with one hand and limits the maximum opening of the snip.
- 3 Compound leverage**
Compound leverage considerably reduces the effort required. Improving productivity while reducing hand fatigue for the worker.
- 4 Ergonomic handle**
The plastic grips on the ergonomically designed handles have soft cushion inserts that further reduce hand fatigue for the worker. The soft cushion inserts also keep the hand from slipping on the grips.

Shape and straight cutting snips, small and manoeuvrable



| N ^o | <a> | | | | ↓ max. ↑ | ⚙ | ⚖ | 📦 | V4 |
|----------------|---|---|-----|-------|----------------|-----|------|------|----|
| | mm | " | mm | " | | | | | |
| D15A | 180 | 7 | 20 | 13/16 | 1,0 | +++ | 0.18 | 10 | |
| D15AL | 180 | 7 | 20 | 13/16 | 1,0 | +++ | 0.18 | 10 | |
| D15A-SB | 180 | 7 | 20 | 13/16 | 1,0 | +++ | 0.20 | 10 | |
| D15AL-SB | 180 | 7 | 20 | 13/16 | 1,0 | +++ | 0.20 | 10 | |
| N ^o | Layout | | | | | | | 📦 | V4 |
| | | | | | | | | qty. | |
| DSET15 | 1 x D15A, 1 x D15S and 1 x D15AL in snips pouch | | | | | | | 1 | |



The shape and straight cutting snips D15A and D15AL will be delivered in an attractive sales presenter. Sale to dealers in packaging units only.



- For long continuous, straight and curved cuts
- The extremely small forged heads have optimized blade geometry is very manoeuvrable; perfect for cutting small radii and in confined spaces
- The compact design results in the highest performance with the minimum of effort
- ERGO-handle for increased comfort reduced hand fatigue!
- Available in right or left cutting versions

High-performance snips with HSS edges

Best solution for every application



Guaranteed high performance

Made from the best grade steel with case hardened HSS cutting edges. Compared to conventional snips, these **HIGH QUALITY – HIGH PERFORMANCE** models will fulfill the most stringent requirements

regarding service life and cutting properties. Great for use on stainless steel & other hard sheet metals. Available in a wide variety of styles! Traditional designs, compound leverage designs, straight cutting, shape cutting, ideal pattern snips. The large selection makes find the right tool for the job easy!

D27AH shape and straight cutting snip – with case-hardened HSS edges for considerably longer service life.

Your benefits at a glance:

1 Longer service life

Tempered drop-forged cutting heads have hardened HSS inserts for a much longer service life and performance than conventional snips. Even when cutting the harder metals like stainless steel.

2 Compound leverage

Compound leverage considerably reduces the effort required. Improving productivity while reducing hand fatigue for the worker.

3 Ergonomic handle

The plastic grips on the ergonomically designed handles have soft cushion inserts that further reduce hand fatigue for the worker. The soft cushion inserts also keep the hand from slipping on the grips.



HSS-TiN shape and straight cutting snips



| № | <a> | | | | ↓ ↑ max. | ⊙ | ⚖ | 📦 | V6 |
|------------|-----|--------|-----|--------|----------------|-------|------|---|----|
| | mm | " | mm | " | | | | | |
| D27AH-TIN | 260 | 10 1/4 | 33 | 1 5/16 | 1,2 | +++++ | 0.56 | 1 | |
| D27AHL-TIN | 260 | 10 1/4 | 33 | 1 5/16 | 1,2 | +++++ | 0.56 | 1 | |



- TiN coated cutter head for longer service life even in case of hard materials
- Case-hardened HSS edges
- For continuous, straight and curved cuts
- Available in right or left cutting versions

High-performance snips with HSS edges

HSS shape and straight cutting snips

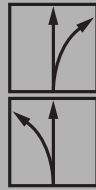

| N ^o | ←a→ | | ←b→ | | ↓ max ↑ | ⚙️ | ⚖️ | 📦 | V6 |
|----------------|-----|--------|-----|--------|---------------|------|------|---|----|
| | mm | " | mm | " | | | | | |
| D27AH | 260 | 10 1/4 | 33 | 1 5/16 | 1,2 | ++++ | 0.56 | 1 | |
| D27AHL | 260 | 10 1/4 | 33 | 1 5/16 | 1,2 | ++++ | 0.56 | 1 | |



- For continuous, straight and curved cuts
- Edges made of case-hardened HSS
- Available in right or left cutting versions

HSS punch snips



| N ^o | ←a→ | | ←b→ | | ↓ max ↑ | ⚙️ | ⚖️ | 📦 | V6 |
|----------------|-----|----|-----|---------|---------------|------|------|---|----|
| | mm | " | mm | " | | | | | |
| D407-275 | 275 | 11 | 42 | 1 5/8 | 1,0 | ++++ | 0.53 | 1 | |
| D407-275L | 275 | 11 | 42 | 1 5/8 | 1,0 | ++++ | 0.53 | 1 | |
| D407-300 | 300 | 12 | 43 | 1 11/16 | 1,0 | ++++ | 0.60 | 1 | |
| D407-300L | 300 | 12 | 43 | 1 11/16 | 1,0 | ++++ | 0.60 | 1 | |



- For short, straight and curved cuts
- Edges made of case-hardened HSS
- PVC dipped handles
- Available in right or left cutting versions

High-performance snips with HSS edges

HSS shape and straight cutting snips



| № | <a> | | | | ↓ max ↑ | ⚙ | ⚖ | 📦 | V6 |
|-----------|-----|----|-----|-------|---------------|------|------|---|----|
| | mm | " | mm | " | | | | | |
| D416-280 | 280 | 11 | 34 | 1 3/8 | 1,0 | ++++ | 0.61 | 1 | |
| D416-280L | 280 | 11 | 34 | 1 3/8 | 1,0 | ++++ | 0.61 | 1 | |



- For continuous, straight and curved cuts
- Cutting edges made of case-hardened HSS
- PVC dipped handles
- Available in right or left cutting versions

HSS pelican snips



| № | <a> | | | | ↓ max ↑ | ⚙ | ⚖ | 📦 | V6 |
|----------|-----|----|-----|--------|---------------|------|------|---|----|
| | mm | " | mm | " | | | | | |
| D418-300 | 300 | 12 | 62 | 2 7/16 | 1,0 | ++++ | 0.71 | 1 | |
| D418-350 | 350 | 14 | 65 | 2 9/16 | 1,0 | ++++ | 0.80 | 1 | |



- For long continuous and straight cuts
- Cutting edges made of case-hardened HSS
- PVC dipped handles
- Available only in right cutting version

Standard tin snips

Traditional style tin snips



Proven, robust and reliable

Standard tin snips are robust and reliable. For any application or any material: The wide range of standard tin snips guarantees that you will find

the right edge shape and cutting grade for your application. Completely forged, exceptionally robust and absolutely reliable. You can rely on them with certainty!

Standard tin snips D216 – Its a classic. Ideally suited for long continuous, straight and curved cuts.

Your benefits at a glance:

- 1 Forged cutter head and handle**
Cutter head and handle are drop-forged as a single unit. This is what makes them so robust and reliable.
- 2 Induction hardened cutting edges**
Extra hard cutting edges guarantee more increased durability and optimal cutting results.
- 3 Bolted joint**
All conventional metal snips can be disassembled for easy sharpening, thus extending their service life!



Shape and straight cutting snips



| N ^o | ←a→ | | ←b→ | | ↓max.↓ | ⌚ | ⚖ | 📦 | V5 |
|----------------|---|--------|-----|--------|--------|----|------|---|----|
| | mm | " | mm | " | | | | | |
| D216-260 | 260 | 10 1/4 | 30 | 1 3/16 | 1,0 | ++ | 0.49 | 5 | |
| D216-260L | 260 | 10 1/4 | 30 | 1 3/16 | 1,0 | ++ | 0.49 | 5 | |
| D216-280 | 280 | 11 | 34 | 1 3/8 | 1,0 | ++ | 0.58 | 5 | |
| D216-280L | 280 | 11 | 34 | 1 3/8 | 1,0 | ++ | 0.58 | 5 | |
| D116-260 | 260 | 10 1/4 | 30 | 1 3/16 | 1,0 | + | 0.49 | 5 | |
| D116-260L | 260 | 10 1/4 | 30 | 1 3/16 | 1,0 | + | 0.49 | 5 | |
| D116-260-SB | 260 | 10 1/4 | 30 | 1 3/16 | 1,0 | + | 0.49 | 5 | |
| D116-260L-SB | 260 | 10 1/4 | 30 | 1 3/16 | 1,0 | + | 0.49 | 5 | |
| D116-280 | 280 | 11 | 34 | 1 3/8 | 1,0 | + | 0.56 | 5 | |
| D116-280L | 280 | 11 | 34 | 1 3/8 | 1,0 | + | 0.56 | 5 | |
| D116-280-SB | 280 | 11 | 34 | 1 3/8 | 1,0 | + | 0.59 | 5 | |
| D116-280L-SB | 280 | 11 | 34 | 1 3/8 | 1,0 | + | 0.59 | 5 | |
| N ^o | Layout | | | | | | | 📦 | V5 |
| DSET-SF3 | 1 x D216-280, 1 x D216-280L and 1 x D218-300 in snips pouch | | | | | | | 1 | |

- For continuous, straight and curved cuts
- D216 – Painted handles
- D116 – PVC dipped handles
- Available in right or left cutting versions



Standard tin snips



- For continuous, straight and curved cuts
- With no opening stop and with extra pointed cutter head
- Edges with micro-serrations for slip-proof working
- Particularly robust, for unusually challenging situations: Snips completely tempered and burnished. Cutter inductively hardened
- PVC dipped handles
- Available in right or left cutting versions
- On carded hang pack

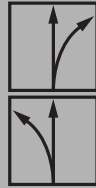

Shape and straight cutting snips, without opening stop

| No | <a> | | | | ↓ max. ↑ | ⚙️ | ⚖️ | 📦 | V5 |
|------------------|-----|----|-----|-------|----------------|----|------|---|----|
| | mm | " | mm | " | | | | | |
| D216-280-B-SBSK | 280 | 11 | 34 | 1 3/8 | 1,0 | ++ | 0.58 | 5 | |
| D216-280L-B-SBSK | 280 | 11 | 34 | 1 3/8 | 1,0 | ++ | 0.58 | 5 | |



You Tube



- For long continuous and straight cuts
- Extra long blade is ideal for cutting through metal sheets
- D218 – Painted handles
- D118 – PVC dipped handles
- Available as right cutter (in 300 mm dimension also available as left cutter)



Pelican snips

| No | <a> | | | | ↓ max. ↑ | ⚙️ | ⚖️ | 📦 | V5 |
|--------------|-----|----|-----|--------|----------------|----|------|---|----|
| | mm | " | mm | " | | | | | |
| D218-300 | 300 | 12 | 62 | 2 7/16 | 1,0 | ++ | 0.73 | 5 | |
| D218-300L | 300 | 12 | 62 | 2 7/16 | 1,0 | ++ | 0.73 | 5 | |
| D218-350 | 350 | 14 | 65 | 2 9/16 | 1,0 | ++ | 0.80 | 5 | |
| D118-300 | 300 | 12 | 62 | 2 7/16 | 1,0 | + | 0.73 | 5 | |
| D118-300L | 300 | 12 | 62 | 2 7/16 | 1,0 | + | 0.73 | 5 | |
| D118-300-SB | 300 | 12 | 62 | 2 7/16 | 1,0 | + | 0.74 | 5 | |
| D118-300L-SB | 300 | 12 | 62 | 2 7/16 | 1,0 | + | 0.74 | 5 | |
| D118-350 | 350 | 14 | 65 | 2 9/16 | 1,0 | + | 0.80 | 5 | |

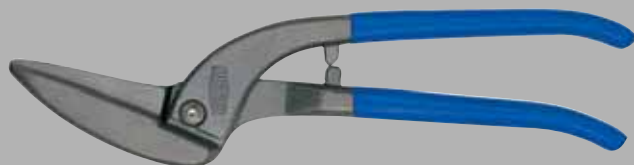

Standard tin snips

Shape cutting punch snips

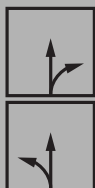

| № | <a> | | | | ↓ ↑ max. | ⚙️ | ⚖️ | 📦 | V5 |
|-----------|-----|----|-----|---------|----------------|----|------|---|----|
| | mm | " | mm | " | | | | | |
| D214-250 | 250 | 10 | 37 | 1 7/16 | 1,0 | ++ | 0.47 | 5 | |
| D214-250L | 250 | 10 | 37 | 1 7/16 | 1,0 | ++ | 0.47 | 5 | |
| D214-275 | 275 | 11 | 43 | 1 11/16 | 1,0 | ++ | 0.53 | 5 | |
| D114-250 | 250 | 10 | 37 | 1 7/16 | 1,0 | + | 0.47 | 5 | |
| D114-250L | 250 | 10 | 37 | 1 7/16 | 1,0 | + | 0.47 | 5 | |



D214-275: While stocks last



- For short, straight and curved cuts (especially small radii)
- Very slick cutting head
- D214 – Painted handles
- D114 – PVC dipped handles
- Available in right or left cutting versions

Punch snips

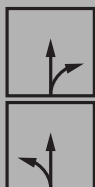

| № | <a> | | | | ↓ ↑ max. | ⚙️ | ⚖️ | 📦 | V5 |
|--------------|-----|----|-----|-------|----------------|----|------|---|----|
| | mm | " | mm | " | | | | | |
| D207-250 | 250 | 10 | 42 | 1 5/8 | 1,0 | ++ | 0.49 | 5 | |
| D207-250L | 250 | 10 | 42 | 1 5/8 | 1,0 | ++ | 0.49 | 5 | |
| D207-275 | 275 | 11 | 42 | 1 5/8 | 1,0 | ++ | 0.53 | 5 | |
| D207-275L | 275 | 11 | 42 | 1 5/8 | 1,0 | ++ | 0.53 | 5 | |
| D207-300 | 300 | 12 | 47 | 1 7/8 | 1,0 | ++ | 0.58 | 5 | |
| D207-300L | 300 | 12 | 47 | 1 7/8 | 1,0 | ++ | 0.58 | 5 | |
| D107-225 | 225 | 9 | 38 | 1 1/2 | 1,0 | + | 0.37 | 5 | |
| D107-225-SB | 225 | 9 | 38 | 1 1/2 | 1,0 | + | 0.38 | 5 | |
| D107-250 | 250 | 10 | 42 | 1 5/8 | 1,0 | + | 0.49 | 5 | |
| D107-250L | 250 | 10 | 42 | 1 5/8 | 1,0 | + | 0.49 | 5 | |
| D107-250-SB | 250 | 10 | 42 | 1 5/8 | 1,0 | + | 0.50 | 5 | |
| D107-250L-SB | 250 | 10 | 42 | 1 5/8 | 1,0 | + | 0.50 | 5 | |
| D107-275 | 275 | 11 | 42 | 1 5/8 | 1,0 | + | 0.55 | 5 | |
| D107-275L | 275 | 11 | 42 | 1 5/8 | 1,0 | + | 0.55 | 5 | |
| D107-300 | 300 | 12 | 47 | 1 7/8 | 1,0 | + | 0.60 | 5 | |
| D107-300L | 300 | 12 | 47 | 1 7/8 | 1,0 | + | 0.60 | 5 | |



- For short, straight and curved cuts
- D207 – Painted handles
- D107 – PVC dipped handles
- Available in right or left cutting versions

Standard tin snips



- Especially for circular cuts
- Semi-circular edges
- Painted handles
- Available in right or left cutting versions



Punch snips with curved blades

| No | <a> | | | | ↓ max. ↑ | ⚙️ | ⚖️ | 📦 | V5 |
|-----------|-----|----|-----|--------|----------------|----|------|---|----|
| | mm | " | mm | " | | | | | |
| D208-275 | 275 | 11 | 40 | 1 9/16 | 1,0 | ++ | 0.51 | 5 | |
| D208-275L | 275 | 11 | 40 | 1 9/16 | 1,0 | ++ | 0.51 | 5 | |



Universal snips



| No | <a> | | | | ↓ max. ↑ | ⚙️ | ⚖️ | 📦 | V5 |
|-------------|-----|----|-----|---------|----------------|----|------|---|----|
| | mm | " | mm | " | | | | | |
| D106-250-SB | 250 | 10 | 68 | 2 11/16 | 1,0 | + | 0.44 | 5 | |



- For straight and curved cuts
- PVC dipped handles
- Available only in right cutting version

Universal snips with wide blade



| No | <a> | | | | ↓ max. ↑ | ⚙️ | ⚖️ | 📦 | V5 |
|--------------|-----|----|-----|-------|----------------|----|------|---|----|
| | mm | " | mm | " | | | | | |
| D106A-250-SB | 250 | 10 | 67 | 2 5/8 | 1,0 | + | 0.46 | 5 | |

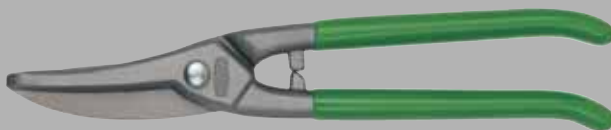

- For straight and curved cuts (large radii)
- PVC dipped handles
- Available only in right cutting version

Standard tin snips

Berlin pattern snips



| N ^o | ← a → | | ← b → | | ↓ max. ↑ mm | ⚙️ | ⚖️ | 📦 | V5 |
|----------------|-------|----|-------|--------|----------------|----|------|---|----|
| | mm | " | mm | " | | | | | |
| D202-250 | 250 | 10 | 60 | 2 3/8 | 1,0 | ++ | 0.47 | 5 | |
| D202-300 | 300 | 12 | 79 | 3 | 1,0 | ++ | 0.70 | 5 | |
| D102-225 | 225 | 9 | 55 | 2 3/16 | 1,0 | + | 0.44 | 5 | |
| D102-250 | 250 | 10 | 60 | 2 3/8 | 1,0 | + | 0.48 | 5 | |
| D102-250-SB | 250 | 10 | 60 | 2 3/8 | 1,0 | + | 0.49 | 5 | |
| D102-300 | 300 | 12 | 79 | 3 | 1,0 | + | 0.72 | 5 | |



English pattern snips



| N ^o | ← a → | | ← b → | | ↓ max. ↑ mm | ⚙️ | ⚖️ | 📦 | V5 |
|----------------|-------|----|-------|---------|----------------|----|------|---|----|
| | mm | " | mm | " | | | | | |
| D159-200 | 200 | 8 | 46 | 1 7/8 | 1,0 | + | 0.29 | 6 | |
| D159-250 | 250 | 10 | 57 | 2 1/4 | 1,0 | + | 0.49 | 6 | |
| D159-300 | 300 | 12 | 68 | 2 11/16 | 1,0 | + | 0.63 | 6 | |
| D159-350 | 350 | 14 | 70 | 2 3/4 | 1,0 | + | 0.83 | 6 | |

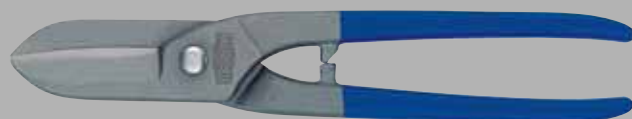

While stocks last



- For straight cuts
- D202 – Painted handles
- D102 – PVC dipped handles
- Available only in right cutting version



- For straight cuts
- Available only in left cutting version
- Painted handles

Standard tin snips



American pattern snips

| No | ← a → | | ← b → | | ↓ max. ↓ mm | ⚙️ | ⚖️ | 📦 | V5 |
|----------|-------|----|-------|---------|----------------|----|------|---|----|
| | mm | " | mm | " | | | | | |
| D146-200 | 200 | 8 | 41 | 1 5/8 | 1,0 | + | 0.32 | 6 | |
| D146-250 | 250 | 10 | 54 | 2 1/3 | 1,0 | + | 0.47 | 6 | |
| D146-300 | 300 | 12 | 68 | 2 11/16 | 1,0 | + | 0.67 | 6 | |
| D146-350 | 350 | 14 | 72 | 2 13/16 | 1,0 | + | 0.75 | 6 | |



- For straight cuts
- Available only in left cutting version
- PVC dipped handles

Display DVK, unstocked

| No | Width x depth x height | ⚖️ | V6 |
|-----|------------------------|------|----|
| | mm | kg | |
| DVK | 500 x 250 x 180 (350) | 3.28 | |



- Wire display for up to 42 snips, 6 different types of snips
- With label, adhesive label and scanner rail
- For counter and perforated panel

Display DVK2, unstocked

| No | Width x depth x height | ⚖️ | V6 |
|------|------------------------|------|----|
| | mm | kg | |
| DVK2 | 190 x 275 x 255 (340) | 1.35 | |



- Wire display for up to 10 snips, 2 different types of snips
- With advertising plate and sticker for D39ASS and D39ASSL or "neutral" for other snips types
- For counter and perforated panel

General purpose snips



D48A-2 combi-snips – multi-purpose comfort with angled edges.

The D49-2 Electricians' scissors – for multicore cables with diameter up to 10 mm.

Universal range of services – and applications

These versatile multi-purpose snips are equally at home in the toolbox, kitchen gadget drawer or garden shed. Always and everywhere. The hard stainless steel blades are well suited both for cutting thin metal sheets as well as a variety of

soft materials such as paper, fabrics and cardboard. Also works well for cutting flowers and light pruning. The handles are plastic with a soft cushion insert for comfort and to prevent slipping. Ergonomic design makes this snip a pleasure to use!

Multi-purpose cutters

- ERGO-handle for increased comfort – reduced hand fatigue!
- Stainless steel blades
- On carded hang pack

Multi-purpose cutters

| N ^o | ←a→ | | ←b→ | | kg | qty. | V5 |
|----------------|-----|-------|-----|-------|------|------|----|
| | mm | " | mm | " | | | |
| D47-2 | 140 | 5 1/2 | 31 | 1 1/4 | 0.05 | 15 | |
| D48-2 | 190 | 7 1/2 | 42 | 1 5/8 | 0.11 | 10 | |



Angled combi snips

- ERGO-handle for increased comfort – reduced hand fatigue!
- Stainless steel blades
- Offset blades
- On carded hang pack

| N ^o | ←a→ | | ←b→ | | kg | qty. | V5 |
|----------------|-----|-------|-----|-------|------|------|----|
| | mm | " | mm | " | | | |
| D48A-2 | 190 | 7 1/2 | 36 | 1 3/8 | 0.11 | 10 | |



Cable cutters

- ERGO-handle for increased comfort – reduced hand fatigue!
- For multicore cables with diameter up to 10 mm
- Stainless steel blades
- On carded hang pack

| N ^o | ←a→ | | kg | qty. | V5 |
|----------------|-----|-------|------|------|----|
| | mm | " | | | |
| D49-2 | 165 | 6 1/2 | 0.12 | 10 | |



Multi-purpose cutters MULTISNIP Master

- For long continuous straight and curved cuts
- All metal parts are made of stainless steel
- Handle made of robust fibreglass-reinforced plastic with a soft material insert
- On carded hang pack

| N ^o | ←a→ | | ←b→ | | mm | kg | qty. | V5 |
|----------------|-----|-------|-----|---|-----|------|------|----|
| | mm | " | mm | " | | | | |
| D51A | 235 | 9 1/4 | 50 | 2 | 0,4 | 0.19 | 5 | |



Multi-purpose cutters

Multi-purpose cutters

| N ^o | <a> | | | | kg | qty. | V5 |
|----------------|-----|-------|-----|-------|------|------|----|
| | mm | " | mm | " | | | |
| D47 | 140 | 5 1/2 | 31 | 1 1/4 | 0.08 | 15 | |
| D48 | 190 | 7 1/2 | 42 | 1 5/8 | 0.12 | 10 | |



- Stainless steel blades
- Edges with serrations for slip-proof working
- On carded hang pack

Angled combi snips

| N ^o | <a> | | | | kg | qty. | V5 |
|----------------|-----|-------|-----|-------|------|------|----|
| | mm | " | mm | " | | | |
| D48A | 190 | 7 1/2 | 38 | 1 1/2 | 0.11 | 10 | |



- Stainless steel blades
- Offset blades
- Edges with serrations for slip-proof working
- On carded hang pack

Cable cutters

| N ^o | <a> | | kg | qty. | V5 |
|----------------|-----|-------|------|------|----|
| | mm | " | | | |
| D49 | 160 | 6 1/4 | 0.12 | 10 | |



- For multicore cables with diameter up to 10 mm
- Stainless steel blades
- On carded hang pack

Multi-purpose cutters Combinox

| N ^o | <a> | | | | kg | qty. | V5 |
|----------------|-----|-------|-----|--------|------|------|----|
| | mm | " | mm | " | | | |
| D50 | 190 | 7 1/2 | 40 | 1 9/16 | 0.14 | 10 | |



- Stainless steel blades
- Ergonomically designed handles with soft-insert
- With wire guide for cutting binding wire to Ø 2.5 mm
- Circular cutting to stop for stripping cable from Ø 1.0 to 1.5 mm
- On carded hang pack

Folding utility knives and multitool

Razor sharp cuts



Your benefits at a glance:

- 1 Blade change mechanism**
Lever for safe locking of blades. This mechanism permits a quick and easy blade change.
- 2 Soft thumb pad**
Soft plastic thumb pad allows maximum pressure.
- 3 Storage compartment**
Safe storage of spare blades so they are always quickly accessible.
- 4 Release lever**
It needs just a short push on the metal release lever to unlock the knife so that it can be safely folded.

- **DBKPH-EU:** Comfortable plastic handle; thumb cushion for max. contact pressure; blade compartment with 5 replacement blades included
- **DBKWH-EU:** High quality wooden handle
- **DBKAH-EU:** Light weight aluminium handle
- Quick blade exchange
- Belt clip
- On carded hang pack

Folding utility knife

| № | <a> | | | | ⚖ kg | 📦 qty. | V6 |
|----------|-----|-------|-----|-------|---------|-----------|----|
| | mm | " | mm | " | | | |
| DBKPH-EU | 160 | 6 1/4 | 28 | 1 1/8 | 0.18 | 12 | |
| DBKWH-EU | 160 | 6 1/4 | 28 | 1 1/8 | 0.20 | 12 | |
| DBKAH-EU | 160 | 6 1/4 | 28 | 1 1/8 | 0.14 | 12 | |



DBKPH-EU



DBKWH-EU



DBKAH-EU



All knives will be delivered in an attractive sales presenter.
Sale to dealers in pack-ging units only.

Knife-set DBKPH

| N ^o | Layout | ☐ | |
|----------------|--|------|----|
| | | qty. | V6 |
| DBKPH-SET | DBKPH Folding locking utility knife with convenient nylon storage case ■ + 15 pc. standard blade DBK-T ■ + 5 pc. hook blade DBK-H ■ + 2 pc. linoleum blade DBK-L ■ + 2 pc. scoring blade DBK-A | 8 | |



The knife-set will be delivered in an attractive sales presenter. Sale to dealers in packaging units only.



- Knife with comfortable plastic handle
- Practical nylon zip-up case
- Four different blades for different tools
- On carded hang pack

Spare blades

| N ^o | ← a → | | Content per unit | ☐ | |
|----------------|-------|-------|------------------|------|------|
| | mm | " | | pcs. | qty. |
| DBK-T | 60 | 2 3/8 | 10 | 1 | |
| DBK-H | 50 | 2 | 10 | 1 | |
| DBK-L | 87 | 3 1/2 | 5 | 1 | |



DBK-T



DBK-H



DBK-L

- Suitable for all BESSEY bladed folding utility knives
- On carded hang pack

Multitool

| N ^o | Overall length open | | Overall length closed | | ← b → | | ⚖ | ☐ | V6 |
|----------------|---------------------|---|-----------------------|---|-------|--------|------|---|----|
| | mm | " | mm | " | mm | " | | | |
| DBST | 175 | 7 | 100 | 4 | 55 | 2 3/16 | 0.36 | 8 | |



The Multitool will be delivered in an attractive sales presenter. Sale to dealers in packaging units only.

- 1 Multitool with 7 options: Shears, blade, saw, file, Phillips head screwdriver and large and small slotted screwdriver
- Cuts: Leather, rope, vinyl, thin cable, cord, thin plastic, paper and much more besides
- With a robust belt pouch for secure, it provides handy storage
- Stainless steel handle with soft cushioned elements for slip-free work
- On carded hang pack

Jewellers' and thin sheet snips

High-precision edges



Best BESSEY quality with the highest precision

BESSEY has over 80 years of experience in manufacturing metal cutting snips. We use this unmatched know-how in all our products.

This becomes self evident to all who use one of these fine jewellers' snips. Having the best quality tools pays off again and again wherever highest precision is required.

Jewellers' and thin sheet snips – wide variety of styles for precision cutting of thin metals!

Jewellers' snips

| No | Description | <a> | | | | kg | qty. | V5 |
|-------|----------------|-----|---|-----|-------|------|------|----|
| | | mm | " | mm | " | | | |
| D70-1 | Straight edges | 180 | 7 | 31 | 1 1/4 | 0.13 | 12 | |
| D71-1 | Curved edges | 175 | 7 | 32 | 1 1/4 | 0.13 | 12 | |



- Closed handles
- Completely nickel coated

Jewellers' snips

| No | Description | <a> | | | | kg | qty. | V5 |
|-------|----------------|-----|---|-----|-------|------|------|----|
| | | mm | " | mm | " | | | |
| D72-1 | Straight edges | 180 | 7 | 31 | 1 1/4 | 0.11 | 12 | |



- Open handles
- Completely nickel coated

Jewellers' snips

| No | Description | <a> | | | | kg | qty. | V5 |
|-------|----------------|-----|---|-----|--------|------|------|----|
| | | mm | " | mm | " | | | |
| D74-1 | Straight edges | 180 | 7 | 34 | 1 3/8 | 0.09 | 12 | |
| D75-1 | Curved edges | 175 | 7 | 33 | 1 5/16 | 0.09 | 12 | |

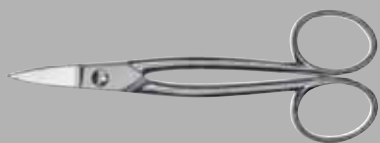

- With handle loops
- Completely nickel coated

Jewellers' snips

| No | Description | <a> | | | | kg | qty. | V5 |
|-------|----------------|-----|---|-----|---|------|------|----|
| | | mm | " | mm | " | | | |
| D76-1 | Straight edges | 180 | 7 | 26 | 1 | 0.14 | 12 | |



- Closed handle with spring
- Completely nickel coated

Household and multi-purpose shears

Multi-purpose shears



- Stainless steel blades
- Comfortable handles loops with soft cushion inserts
- On carded hang pack

| N ^o | ←a→ | | ←b→ | | kg | qty. | V5 |
|----------------|-----|-------|-----|-------|------|------|----|
| | mm | " | mm | " | | | |
| D820-200 | 200 | 7 7/8 | 80 | 3 1/3 | 0.07 | 12 | |
| D820-250 | 250 | 10 | 105 | 4 1/4 | 0.10 | 12 | |



Multi-purpose shears

- Stainless steel blades
- Comfortable handles loops with soft cushion inserts
- On carded hang pack

| N ^o | ←a→ | | ←b→ | | kg | qty. | V5 |
|----------------|-----|-------|-----|-------|------|------|----|
| | mm | " | mm | " | | | |
| D821-160 | 160 | 6 1/4 | 70 | 2 3/4 | 0.04 | 12 | |
| D821-180 | 180 | 7 | 80 | 3 1/3 | 0.06 | 12 | |



Electricians' scissors



- Nickel plated serrated blades
- With a wire cutter

| N ^o | ←a→ | | ←b→ | | kg | qty. | V5 |
|----------------|-----|---|-----|--------|------|------|----|
| | mm | " | mm | " | | | |
| D53 | 125 | 5 | 40 | 1 9/16 | 0.07 | 12 | |



Household and multi-purpose shears

Erdi

Household and dressmakers' shears

| N ^o | <a> | | | | kg | qty. | V5 |
|----------------|-----|---|-----|---|------|------|----|
| | mm | " | mm | " | | | |
| D840-150 | 150 | 6 | 50 | 2 | 0.07 | 12 | |
| D840-180 | 180 | 7 | 77 | 3 | 0.09 | 12 | |



- Completely nickel coated

Paperhangers' and paper shears

| N ^o | <a> | | | | kg | qty. | V5 |
|----------------|-----|---|-----|-------|------|------|----|
| | mm | " | mm | " | | | |
| D853-200 | 200 | 8 | 95 | 3 3/4 | 0.08 | 12 | |



- Completely nickel coated

Industrial and professional shears

| N ^o | <a> | | | | kg | qty. | V5 |
|----------------|-----|----|-----|-------|------|------|----|
| | mm | " | mm | " | | | |
| D860-200 | 200 | 8 | 80 | 3 1/3 | 0.20 | 6 | |
| D860-225 | 225 | 9 | 85 | 3 1/4 | 0.27 | 6 | |
| D860-250 | 250 | 10 | 90 | 3 1/2 | 0.36 | 6 | |



- Robust design
- Black handle
- Oblong and round handle loops

Safety strap cutter

One-handed cutting of strong steel straps



Secure – with just one hand!

With the D123S BESSEY offers you the unique, single-handed operation steel strap cutter, which can even cut through 32 x 1 mm hardened steel straps. This means that over half of all commonly-used packaging straps can be cut, for example, steel strapping on wooden crates. With an overall length of just 260 mm it is very short and so light and easy to handle. The cutter head is flat formed and can be easily slid underneath tightly tensioned straps. During the cutting process a retainer holds the strap tightly and thus prevents it from springing up dangerously. If you are looking for safe handling using only one hand, then the D123S is unbeatable – simply peerless!

Your benefits at a glance:

1 Tempered cutter head

The tempered fine-cast cutter head cuts steel straps up to 32 x 1 mm. The cutting edge is induction hardened for long service life.

2 Strap holding element

The holding-down element made of polymer material prevents the strap from snapping upwards. For your safety.

3 Compound leverage

Compound leverage reduces the effort required considerably. This improves productivity while reducing hand fatigue for the worker.

4 Ergonomic handle

The plastic grips on the ergonomically designed handles have soft cushion inserts that further reduce hand fatigue for the worker. The soft cushion inserts also keep the hand from slipping on the grips.

Steel strap cutters

Safety strap cutter with compound leverage

| N ^o | ←a→ | | ←b→ | | kg | qty. | V5 |
|----------------|-----|--------|-----|-------|------|------|----|
| | mm | " | mm | " | | | |
| D123S | 260 | 10 1/4 | 38 | 1 1/2 | 0.55 | 5 | |
| D123S-SB | 260 | 10 1/4 | 38 | 1 1/2 | 0.56 | 5 | |



- One-handed operation with little effort thanks to double leverage
- Metal fastening will not spring up dangerously due to safety hold mechanism in the snip
- Flat lower jaw easily slips under taut banding
- Can even be used with hardened steel belts (560 N/mm²) with belt widths up to 32 mm, belt thicknesses up to 1 mm

Steel strap cutter

| N ^o | ←a→ | | ←b→ | | kg | qty. | V5 |
|----------------|-----|---|-----|-------|------|------|----|
| | mm | " | mm | " | | | |
| D122N | 225 | 9 | 31 | 1 1/4 | 0.40 | 5 | |

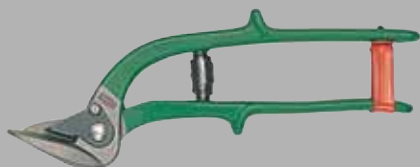

- The lower holder prevents band ends from springing up
- For band width up to 25 mm, band thickness up to 0.6 mm
- Flat lower jaw easily slips under taut banding
- Painted handles

Steel strap cutter

| N ^o | ←a→ | | ←b→ | | kg | qty. | V5 |
|----------------|-----|--------|-----|--------|------|------|----|
| | mm | " | mm | " | | | |
| D122A | 260 | 10 1/4 | 30 | 1 3/16 | 0.42 | 5 | |
| D122A-SB | 260 | 10 1/4 | 30 | 1 3/16 | 0.43 | 5 | |



- Flat lower jaw easily slips under taut banding
- High price to performance ratio
- For band width up to 25 mm, band thickness up to 0.6 mm
- PVC dipped handles

Tools for sheet metal work and plumbing

Special tools for specialists



Developed by professionals in the field of cutting technology

Being specialists ourselves, we know what specialists appreciate: highest quality and maximum reliability. Tools for sheet metal work –

and plumbing by BESSEY provide you with both. These drop-forged, quality steel tools distinguish themselves due to their robustness and durability. Designed to the highest standards and to be the best! Designed to never let you down! Designed to be in your toolbox, because you want only the best!

Tools for sheet metal work and plumbing. Highest professional quality.

Seaming and clinching pliers

| № | Form | Pivot screw version | Jaw width | | <a> | | kg | qty. | V6 |
|---------|----------|---------------------|-----------|-----|--------|------|----|------|----|
| | | | mm | mm | mm | " | | | |
| D33-60 | straight | passed through | 60 | 280 | 11 | 0.60 | 6 | | |
| D331-40 | straight | put on | 40 | 280 | 11 | 0.56 | 6 | | |
| D331-60 | straight | put on | 60 | 280 | 11 | 0.63 | 6 | | |
| D331-80 | straight | put on | 80 | 320 | 12 3/4 | 0.92 | 5 | | |
| D34-60 | 45° bent | passed through | 60 | 270 | 10 3/4 | 0.72 | 6 | | |
| D341-40 | 45° bent | put on | 40 | 270 | 10 3/4 | 0.69 | 6 | | |
| D341-60 | 45° bent | put on | 60 | 270 | 10 3/4 | 0.63 | 6 | | |
| D341-80 | 45° bent | put on | 80 | 320 | 12 3/4 | 0.92 | 5 | | |
| D35-60 | 90° bent | passed through | 60 | 255 | 10 | 0.71 | 6 | | |
| D351-60 | 90° bent | put on | 60 | 255 | 10 | 0.67 | 6 | | |



- Forged in quality steel
- Black powder coated
- Minimum jaw depth straight 60 mm
- Minimum jaw depth bent 50 mm

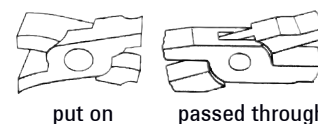

Seaming and clinching pliers, PVC-coated handle

| № | Form | Pivot screw version | Jaw width | | <a> | | kg | qty. | V6 |
|-----------|----------|---------------------|-----------|-----|--------|------|----|------|----|
| | | | mm | mm | mm | " | | | |
| D33-60-P | straight | passed through | 60 | 280 | 11 | 0.60 | 6 | | |
| D331-60-P | straight | put on | 60 | 280 | 11 | 0.62 | 6 | | |
| D34-60-P | 45° bent | passed through | 60 | 270 | 10 3/4 | 0.64 | 6 | | |
| D341-60-P | 45° bent | put on | 60 | 270 | 10 3/4 | 0.63 | 6 | | |
| D35-60-P | 90° bent | passed through | 60 | 255 | 10 | 0.71 | 6 | | |
| D351-60-P | 90° bent | put on | 60 | 255 | 10 | 0.67 | 6 | | |



- Forged in quality steel
- Black powder coated
- PVC-coated handle
- Minimum jaw depth straight 60 mm
- Minimum jaw depth bent 50 mm

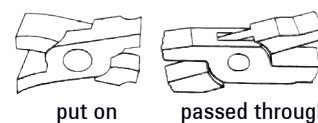

Mini-folding pliers

| № | Form | Pivot screw version | Jaw width | | <a> | | kg | qty. | V6 |
|---------|----------|---------------------|-----------|-----|-----|------|----|------|----|
| | | | mm | mm | mm | " | | | |
| D331-22 | straight | put on | 22 | 180 | 7 | 0.21 | 10 | | |
| D341-22 | 45° bent | put on | 22 | 180 | 7 | 0.19 | 10 | | |



- For small and precise seaming – and bending operations
- Forged from quality steel
- PVC-coated handles
- Completely hardened
- Jaw depth straight 30 mm
- Jaw depth bent 28 mm

Tools for sheet metal work and plumbing

- Forged from quality steel
- PVC-coated handles
- Flat jawed pliers
- Jaw depth 45 mm
- Serration every 0.8 mm

Flat-nosed pliers for sheet metal work

| N ^o | Pivot screw version | ← a → | | kg | qty. | V6 |
|----------------|---------------------|-------|-------|------|------|----|
| | | mm | " | | | |
| D301 | put on | 240 | 9 1/2 | 0.40 | 6 | |



Round nosed pliers

| N ^o | Pivot screw version | ← a → | | kg | qty. | V6 |
|----------------|---------------------|-------|--------|------|------|----|
| | | mm | " | | | |
| D311 | put on | 260 | 10 1/4 | 0.38 | 6 | |



- Forged from quality steel
- PVC-coated handles
- Round jawed pliers
- Jaw depth 50 mm
- Serration every 1 mm



- Forged from quality steel
- Bronzed
- PVC-coated handles

Folding pliers

| N ^o | Form | Pivot screw version | Jaw width | ← a → | | kg | qty. | V6 |
|----------------|----------|---------------------|-----------|-------|----|------|------|----|
| | | | mm | mm | " | | | |
| D355 | straight | put on | 30 | 250 | 10 | 0.43 | 5 | |



Corner seaming and clinching pliers

| N ^o | Form | Pivot screw version | Jaw width | ← a → | | kg | qty. | V6 |
|----------------|----------|---------------------|-----------|-------|----|------|------|----|
| | | | mm | mm | " | | | |
| D335 | straight | put on | 60 | 280 | 11 | 0.74 | 5 | |



- Forged from quality steel
- Bronzed
- PVC-coated handles
- Jaw depth 65 mm

Squeeze folding pliers

| No | Form | Pivot screw version | Jaw width | | ← a → | | kg | qty. | V6 |
|------|----------|---------------------|-----------|-----|-------|-----|------|------|----|
| | | | mm | mm | mm | " | | | |
| D336 | straight | passed through | 80 | 320 | 12 | 3/4 | 0.78 | 5 | |



- Forged in quality steel
- Burnished
- PVC-coated handles
- Jaw depth 80 mm

Crimper

| No | ← a → | | kg | qty. | V6 |
|-----|-------|----|------|------|----|
| | mm | " | | | |
| D36 | 250 | 10 | 0.47 | 1 | |



- 3 bottom- and 2 top jaws enable quick and efficient work
- Self-opening
- Completely galvanised
- PVC-coated handles
- Jaw depth 28 mm

Gutter support bowing pliers

| No | ← a → | | kg | qty. | V6 |
|------|-------|----|------|------|----|
| | mm | " | | | |
| D396 | 680 | 20 | 3.10 | 1 | |



- 10 mm recess width for gutter irons up to 40 x 6 mm
- Head made of rust-proof malleable cast iron
- Gliding role for protecting the plastic-coated gutter irons

Alphabetic register

| | | | |
|---|------------------------------------|-------------------------------------|----------------------------|
| A | | F | |
| Accessories | 16, 26, 29, 38, 45, 47, 50, 64, 95 | Fitters' clamp | 39 |
| Adapter for multi-purpose table STC-SET-T20 | 79 | Flat-nosed pliers | 172 |
| All-steel screw clamp | 25, 26, 27 | Flooring and clamping system | 127 |
| Aluminium mini clamp | 101 | Folding utility knife | 162 |
| American pattern snips | 158 | Framing set | 83 |
| Angle clamp | 111 | G | |
| Angle door frame straightening clamp | 123 | Gearclamp | 87 |
| Area pressure clamp | 85 | Grip plier | 55 |
| Aviation snips D16/D16L/D16S | 145 | Gutter support bowing pliers | 173 |
| B | | H | |
| Band clamps | 109 | High-performance clamp | 36, 37, 38, 39 |
| BAS-C compact clamp | 70 | Horizontal toggle clamp | 77 |
| BAS-CB compact clamp | 70 | Household and dressmakers' shears | 167 |
| Base unit | 71 | I | |
| Berlin pattern snips | 157 | Industrial and professional shears | 167 |
| Box clamp | 85 | J | |
| C | | Jewellers' snips | 165 |
| Cable cutters | 160, 161 | K | |
| Cast iron screw clamp | 101 | K Body Extender | 84 |
| C-clamp | 53 | K Body REVO parallel clamp | 82 |
| C-frame edge clamp | 114 | Kantenfix | 113 |
| C-grip | 55 | KliKlamp | 99 |
| Clamp trolley | 133 | KombiKlamp | 41 |
| Clamping elements for multifunction tables | 79, 118 | L | |
| Clamping elements for welding tables | 62, 63, 64, 65, 67, 117 | Lever clamp | 32, 33 |
| Clamping elements for workbenches | 116 | Light duty bar clamp U-style | 100 |
| Claw clamp | 47 | Lightweight parallel clamp UniKlamp | 85 |
| Claw machine clamp | 72 | M | |
| Clippix | 107 | Machine table clamp | 70, 72, 73 |
| Combinox | 161 | Malleable cast iron screw clamp | 15, 16, 17, 18, 19, 20, 21 |
| D | | Metal angle clamp | 59 |
| Deep throat clamp | 21 | Mini folding pliers | 171, 172, 173 |
| Demonstration trolley | 132 | Mitre clamping system | 111 |
| Door frame assembly | 124 | Multi angle pad | 57 |
| Door frame brace extension | 123 | Multi-function tool | 163 |
| Door frame clamp | 123 | Multi-function/laser fixture | 131 |
| Door frame straightening clamp | 123 | Multi-purpose cutters | 160, 161 |
| DSET15 | 147 | Multi-purpose shears | 166 |
| DSET16 | 145 | MULTISNIP Longstyle D22A | 144 |
| DSET29-15 | 142 | MULTISNIP Master D51A | 160 |
| DSET-SF3 | 153 | Multitool | 163 |
| DuoKlamp | 92 | O | |
| E | | Omega screw clamp | 29 |
| Earth (ground) clamp | 56 | One-handed clamp | 89, 91, 93 |
| Edge clamp | 57, 113, 114 | One-handed edge clamp | 113 |
| Electricians' scissors | 166 | One-handed table clamp | 105 |
| English pattern snips | 157 | | |
| Extender | 84 | | |

| | | | |
|--|--------------------|---|---------------|
| P | | T | |
| Panel carrier | 114 | Table clamp | 84, 102 |
| Paperhangers' and paper shears | 167 | Telescopic drywall support | 129, 130, 131 |
| Parallel grip | 55 | Tilting K Body clamp adapter | 84 |
| Parallel screw clamp | 101 | Toggle clamp | 76, 77, 78 |
| Pelican snips D218/D118 | 154 | Tools for sheet metal work and plumbing | 171, 172, 173 |
| Pelican snips HSS D418 | 151 | | |
| Pipe clamping | 124 | U | |
| Pipe grip | 55 | U-clamp | 44, 45 |
| Pipe-pulling pliers | 173 | UniKlamp | 85 |
| POS Presentation | 132, 133 | Universal snips | 156 |
| Pressure cap strips | 16, 26, 29 | Universal snips with wide blade | 156 |
| Pressure piece | 47 | U-shaped all-steel screw clamp | 44 |
| Punch snips D207/D107 | 155 | U-shaped high-performance clamp | 44, 45 |
| Punch snips HSS D407 | 150 | U-shaped lever clamp | 45 |
| Punch snips with curved blades | 156 | | |
| Push/pull clamp | 78 | V | |
| | | Variable high-performance clamp | 50 |
| Q | | Variable jaw | 83 |
| Quick clamp | 77, 78 | Vario corners | 109 |
| | | VarioClippix | 107 |
| R | | Variogrip | 55 |
| Rafter clamps | 95 | Vertical toggle clamp | 76 |
| Replacement contact surface | 131 | | |
| Round nosed pliers | 172 | W | |
| | | Welding clamp set | 59 |
| S | | Window installation clamp | 124 |
| Safety strap cutter with compound leverage | 169 | Wood Klemmy | 101 |
| Sales display | 132 | Wrench with T-bar | 71 |
| Sash clamp | 125 | | |
| Seaming tool | 120, 121 | | |
| Shape and straight cutting snips D08 | 144 | | |
| Shape and straight cutting snips D15A | 147 | | |
| Shape and straight cutting snips D17ASS/D17A | 144 | | |
| Shape and straight cutting snips D216/D116 | 153 | | |
| Shape and straight cutting snips D216-280-B-SBSK | 154 | | |
| Shape and straight cutting snips D27A | 143 | | |
| Shape and straight cutting snips D29ASS-2 | 142 | | |
| Shape and straight cutting snips D39ASS | 141 | | |
| Shape and straight cutting snips HSS D27AH | 150 | | |
| Shape and straight cutting snips HSS D416 | 151 | | |
| Shape and straight cutting snips TiN D27AH-TiN | 149 | | |
| Shape cutting punch snips D214/D114 | 155 | | |
| Shape cutting snips D27 | 143 | | |
| Shape cutting snips D29SS-2 | 142 | | |
| Spacer | 127 | | |
| Spare blades | 163 | | |
| Special pressure plate | 38, 45, 50, 64, 95 | | |
| Spring clamp | 107 | | |
| Steel strap cutter | 169 | | |
| Straight cutting snips D27B | 143 | | |
| Straight cutting snips D29BSS-2 | 142 | | |
| Support plate | 131 | | |



Simply better.



E-Newsletter



<http://www.bessey.de>



http://www.instagram.com/besseytool_official



<https://www.facebook.com/BESSEY.Tool.Einfach.Besser>



<http://www.youtube.com/user/besseytoolsdeutsch>



<http://newsletter.bessey.de>

www.bessey.de

BESSEY Tool GmbH & Co. KG ■ Mühlwiesenstraße 40
74321 Bietigheim-Bissingen, Germany
Fon +49 7142 401-0 ■ Fax +49 7142 401-452
E-Mail: info@bessey.de

X-ON Electronics

Largest Supplier of Electrical and Electronic Components

Click to view similar products for [Hand Tools](#) category:

Click to view products by [BESSEY](#) manufacturer:

Other Similar products are found below :

[58284-1](#) [662908-1](#) [68764-0001](#) [690619-6](#) [D20419-189](#) [7-354778-7](#) [768531-1](#) [821903-5](#) [822253-1](#) [854183-1](#) [854358-1](#) [992258-1](#) [1-21046-3](#)
[1-22278-0](#) [1-22278-2](#) [1-24954-2](#) [125529-5](#) [126513-1](#) [1-305579-8](#) [1320846-1](#) [1338618-1](#) [1338968-2](#) [1-354779-0](#) [1-354779-2](#) [1-354779-4](#)
[1424443-1](#) [1424289-1](#) [1424444-1](#) [MS24256A16](#) [1-525442-0](#) [1532195-2](#) [1538773-2](#) [1-59681-8](#) [1-59907-5](#) [1-692134-3](#) [1725760-1](#) [HT-](#)
[920A-124-HTELE-RPL-KIT](#) [1976923-1](#) [1976969-1](#) [2063794-1](#) [2063795-1](#) [2-21002-1](#) [2-21002-3](#) [2-21002-4](#) [2-21002-7](#) [2-21002-9](#) [2-21004-](#)
[0](#) [229399-2](#) [229707-1](#) [911737-2](#)