



贝特卫士®

更好的电路安全卫士!  
You build electronics, We safeguard them!

# 承 认 书

## APPROVAL SHEET

编 号 No.	5221100201-C/5-T
日期 Date	2020.02.20

客 户 Customer	
-----------------	--

品 名 Product	Cartridge Fuse-link
系 列 Series	522 Series

料号 Part No.	规格描述 Specification	备注 Remark
贝特电子 Betterfuse		
客 户 Customer		

环保特别提示 Special instructions for environmental protection
本产品:

供应商-贝特电子 Supplier-Betterfuse	零件承认章 Approval Signet	客 户 Customer	零件承认章 Approval Signet
制 作 Make	YaLan Wang		
审 核 Check	Gao Fei		
确 认 Approval	Jun Li		

联络 Contact			
业务 Sales	电话 Telephone	手机 Cellphone	邮箱 E-mail
零件承认后敬请回签一份给我司留存, 或将承认后的封面传真(0769-8352 1857)至我司, 谢谢!			



Document Record						
No.	Date	Modified Content	Page	Edition	Prepared/modified by	Checked by
1	2012.08.25	Draft	9	A/0	Runsong Zhong	Lianghua Guo
2	2014.07.27	Release Edition	8	B/0	Kings Luo	Wenhua Yan
3	2015.03.12	Add KC Certification	3,7	B/1	Kings Luo	Wenhua Yan
4	2015.05.05	Lead standard length: 38mm change as 30mm	4	B/2	Kings Luo	Wenhua Yan
5	2015.06.25	Add UR certification	7	B/3	Jeffery	Gem Guo
6	2015.07.27	Add 12.5A PSE , Update UR certification	6	B/4	Jeffery	Gem Guo
7	2015.08.05	Add 12.5A VDE certification	3	B/5	Jeffery	Gem Guo
8	2015.12.12	Update the PSE certification and add the packaging code for 15.	5	B/6	Jeffery	Lin Gao
9	2016.09.28	Modify the CCC certificate no.		B/7	Jeffery	WenQiang Luo
10	2017.04.05	Update 3.15A I2T Value	6, 7	B/8	Jeffery	WenQiang Luo
11	2017.01.05	Update CCC certification		C/0	J.Q.	Fei Gao
12	2018.10.11	Add the TUV certification		C/1	Xiang Xiong	Fei Gao
13	2019.10.30	Update CQC certification		C/2	YaLan Wang	Fei Gao
14	2019.11.21	Update 8A 10A CQC certification		C/3	YaLan Wang	Fei Gao
15	2020.01.06	Update CCC certification		C/4	YaLan Wang	Fei Gao
16	2020.02.20	Add Resistance value		C/5	YaLan Wang	Fei Gao

## TABLE OF CONTENTS

1. SCOPE AND DESCRIPTION.....	3
2. GENERAL INFORMATION.....	3
3. AGENCY APPROVALS.....	3
4. PART NUMBERING SYSTEM.....	4
5. MECHANICAL SPECIFICATIONS.....	5
6. ELECTRICAL SPECIFICATIONS.....	6
7. SOLDERING PARAMETERS.....	8
8. ORDERING INFORMATION.....	8
9. PACKING INFORMATION.....	9
10. APPENDIX.....	10



## 1. SCOPE AND DESCRIPTION



Following electronic product specifications apply to fuses of the 522 series. The 522 series is a cartridge fuse link for over-current protection.

With its low breaking capacity, the 522 fuse series is ideal for supplementary protection in electrical appliances and equipment to provide excellent protection for components or circuits.

## 2. GENERAL INFORMATION





### General Description

522 series time-lag fuse with low breaking capacity for use with printed circuit boards is used in a large variety of applications. This 5x20mm device is constructed of a glass tube with electro-plated brass end caps. The 522 series with 250 VAC rating and 35A or 10In Ampere breaking capacity, offers excellent quality and is 100% tested for cold resistance and precise length.

### Detailed Features

- Miniature fuse with time-lag, low breaking capacity
- 5mm x 20mm physical dimensions
- Glass tube, encapsulated design with nickel - plated brass end caps
- Optional axial leads are  $\Phi 0.65\text{mm} \times 38\text{mm}$  @ 100mA~7A,  $\Phi 0.8\text{mm} \times 38\text{mm}$  @ 8A~12.5A;  $\Phi 1.0\text{mm} \times 38\text{mm}$  @ 15A and 16A
- Protection against harmful over-currents in primary and secondary applications.
- Lead-free, Halogen-free, RoHS compliant
- Designed compliant to IEC 60127-2/ II

## 3. AGENCY APPROVALS

Agency	Agency File Number	Ampere/ Voltage Range
	E300003	250V AC: 100mA~800mA; 1A~3.15A; 4~8A; 10A~15A
	40019022 40042731	250V AC: 500mA; 1A; 1.6A; 2A; 2.5A; 3.15A; 4A; 5A; 6.3A; 8A; 10A 250V AC: 12.5A
	CQC05012012795 CQC06012017150	250V: 8A; 10A 250V: 12.5A; 16A
	PSE15020944 PSE15020936 PSE15020906	250V: 1A; 1.6A; 2A; 2.5A; 3.15A; 4A; 5A 250V: 6.3A 250V: 12.5A



	2004010207122270	250V: 250mA; 315mA; 500mA; 1A; 1.6A; 2A; 2.5A; 3.15A; 4A; 5A; 6.3A
	SU05042-14007	250V AC: 3.15A, 5A, 6.3A
	J50415641	250V: 250mA; 315mA; 400mA; 1.25A; 12A; 15A; 16A

## 4. PART NUMBERING SYSTEM

### 4.1 Part Number

Example: 5221100201

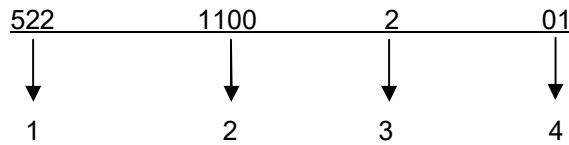

- |                              |                                      |
|------------------------------|--------------------------------------|
| 1 .Product Series .....      | 522                                  |
| 2 .Ampere Rating .....       | 1A (see table 4.2 below)             |
| 3 .Max. Voltage Rating ..... | 1-125V 2 – 250V                      |
| 4 .Supplementary Code .....  | Complement Code(see table 4.3 below) |

### 4.2 Ampere / Voltage Rating Table

AMP CODE	CURRENT RATING	VOLTAGE RATING
0100	100mA	250V AC
0125	125mA	250V AC
0160	160mA	250V AC
0200	200mA	250V AC
0250	250mA	250V AC
0315	315mA	250V AC
0400	400mA	250V AC
0500	500mA	250V AC
0630	630mA	250V AC
0800	800mA	250V AC
1100	1.00A	250V AC
1125	1.25A	250V AC
1150	1.50A	250V AC
1160	1.60A	250V AC
1200	2.00A	250V AC
1250	2.50A	250V AC
1300	3.00A	250V AC
1315	3.15A	250V AC
1350	3.50A	250V AC
1400	4.00A	250V AC
1500	5.00A	250V AC
1630	6.30A	250V AC

### 4.3. Supplementary Code

CODE	DESIGNATION
00	without leads
01	Octangular cap Φ0.65mm
02	Round Cap Φ0.65mm
03	Octangular cap Φ0.8mm
04	Round Cap Φ0.8mm
05	Octangular cap Φ1.0mm
06	Round Cap Φ1.0mm
.	.
.	.
31	Taping



AMP CODE	CURRENT RATING	VOLTAGE RATING
1700	7.00A	250V AC
1800	8.00A	250V AC
2100	10.00A	250V AC
2120	12.00A	250V AC
2125	12.50A	250V AC
2150	15.00A	250V AC
2160	16.00A	250V AC

### 5. MECHANICAL SPECIFICATIONS

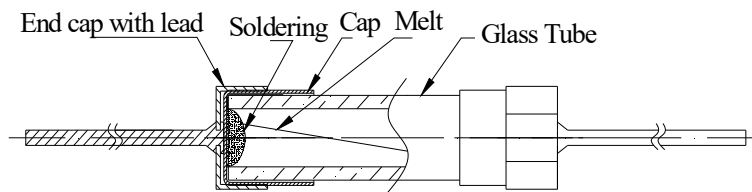
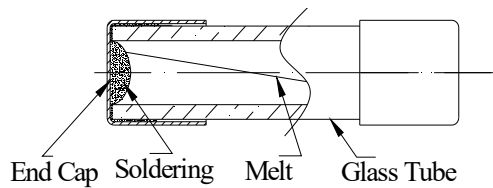

Dimensions (units: mm)

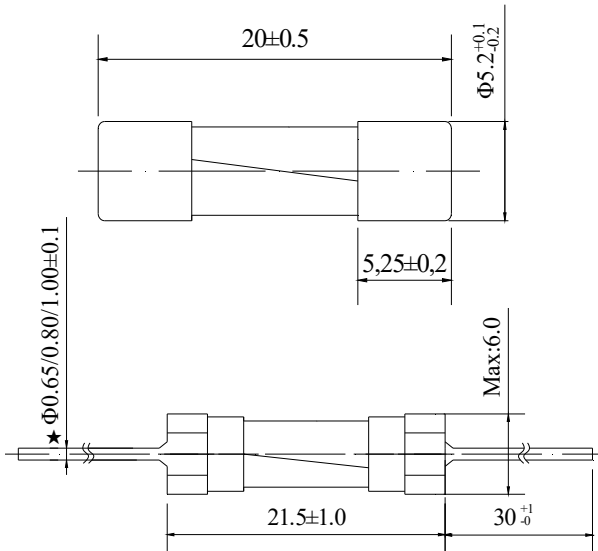

Note: ★  
 100mA~7.0A \*\* Φ0.65mm  
 8.0A~12.5A \*\* Φ0.80mm  
 15.0A~16A \*\* Φ1.00mm

**Operating Temperature:**

-55°C to +125°C

**Storage Conditions:**

+10°C to +60°C

Relative humidity: ≤ 75% yearly average  
 without dew, maximum 30 days at 95%

**Vibration Resistance:**

24 cycles at 15 min. each (60068-6)

10-60Hz at 0.75mm amplitude

60-2000Hz at 10g acceleration



## 6. ELECTRICAL SPECIFICATIONS

### Time vs Current Characteristics Table

(measured with constant current power supply)

Time vs Current Characteristics: IEC 60127-2/III					
Rated Current	150%	210%	275%	400%	1000%
100mA	>1h	<2min	200ms-10s	40ms-3s	10ms~300ms
125mA~10A	>1h	<2min	600ms~10s	150ms~3s	20ms~300ms
12A~16A	>30min	<5min	600ms~15s	150ms~5s	20ms~400ms

### Average Time Current (I-T) Curves

Average Current Curve(I-T Curve)

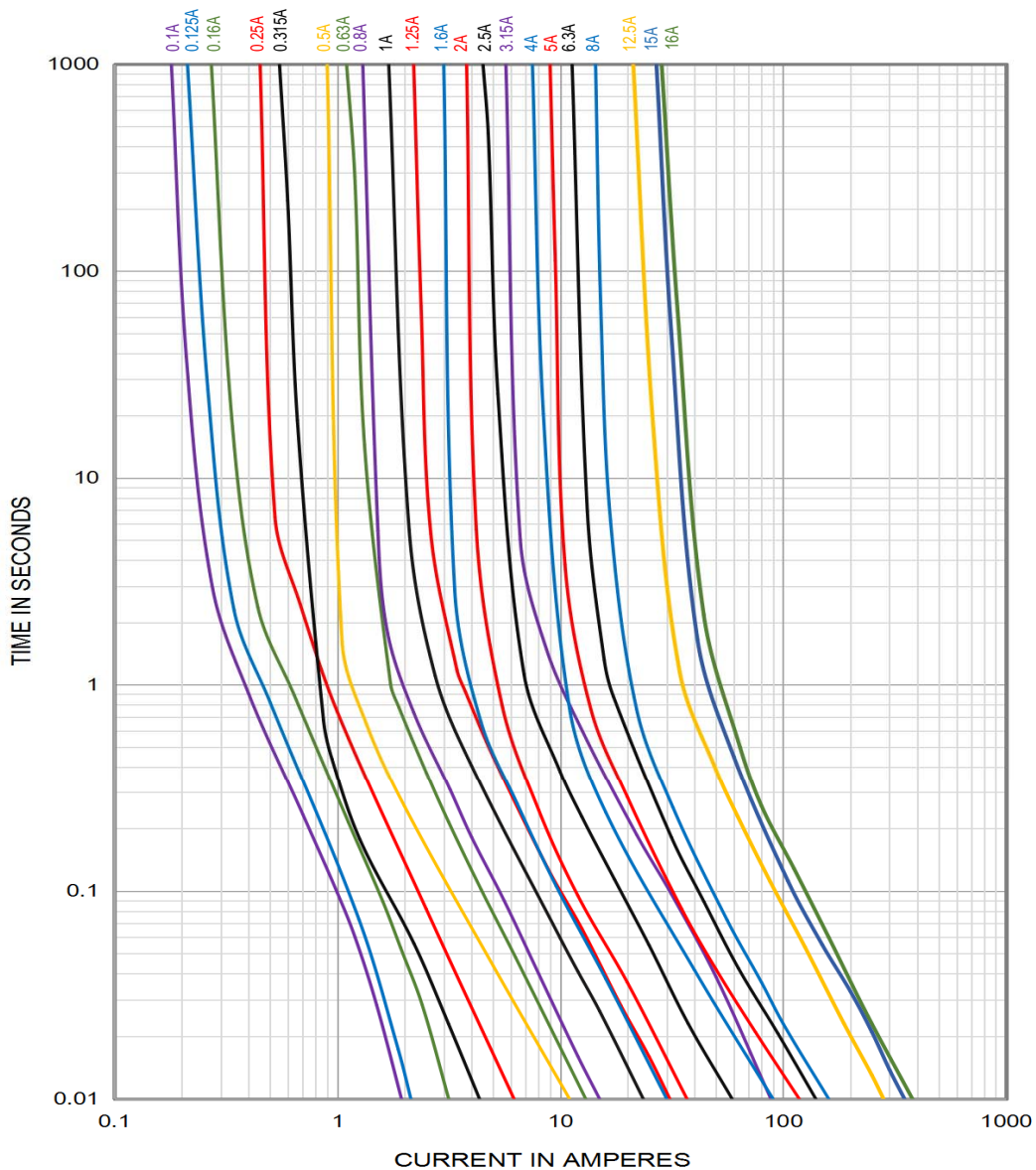



Electrical characteristics

Electrical Characteristics at 25°C														
Amp	Rated Current	Max Voltage	Max Voltage Drop(mV)	Max.Power Dissipation (W)	Nominal Melting I <sup>2</sup> t(A <sup>2</sup> sec)	Typical Code Resistance ±20%(ohms)	Breaking Capacity	Approvals						
								VDE	CQC	cURus	PSE	CCC	KC	TUV
0100	100mA	250V AC	2500	1.6	0.036	-	35A or 10In@250V AC 50-60Hz Cosφ=0.7~0.8	○	○	●	○	○	○	○
0125	125mA		2000	1.6	0.052	-		○	○	●	○	○	○	○
0160	160mA		1900	1.6	0.087	-		○	○	●	○	○	○	○
0200	200mA		1500	1.6	0.123	-		○	○	●	○	○	○	○
0250	250mA		1300	1.6	0.384	860		○	○	●	○	●	○	●
0315	315mA		1100	1.6	0.462	320		○	○	●	○	●	○	●
0400	400mA		1000	1.6	0.723	225		○	○	●	○	○	○	●
0500	500mA		900	1.6	1.21	185.3		●	○	●	○	●	○	○
0630	630mA		300	1.6	1.69	135.0		○	○	●	○	○	○	○
0800	800mA		250	1.6	2.25	96.30		○	○	●	○	○	○	○
1100	1.00A		150	1.6	5.52	71.00		●	○	●	●	●	○	○
1125	1.25A		150	1.6	9.61	51.00		○	○	●	○	○	○	●
1150	1.50A		150	1.6	6.25	65.00		○	○	●	○	○	○	○
1160	1.60A		150	1.6	9	42.00		●	○	●	●	●	○	○
1200	2.00A		150	1.6	13.69	32.00		●	○	●	●	●	○	○
1250	2.50A		120	1.6	36	41.50		●	○	●	●	●	○	○
1300	3.00A		120	1.6	37.6	-		○	○	●	○	○	○	○
1315	3.15A		100	1.6	75	17.20		●	○	●	●	●	○	○
1350	3.50A		100	1.6	57.9	-		○	○	○	○	○	○	○
1400	4.00A		100	1.6	81	14.30		●	○	●	●	●	○	○
1500	5.00A		100	1.6	139	10.80		●	○	●	●	●	○	○
1630	6.30A		100	1.6	196	8.20		●	○	●	●	●	○	○
1700	7.00A		100	1.6	212	-		○	○	●	○	○	○	○
1800	8.00A		100	4	256	6.50		●	●	●	○	○	○	○
2100	10.00A		100	4	576	5.30		●	●	●	○	○	○	○
2120	12.00A		100	4	676	4.10		○	○	●	○	○	○	●
2125	12.50A		100	4	795	4.30		●	●	●	○	○	○	○
2150	15.00A		100	4	1100	3.10		○	○	●	○	○	○	●
2160	16.00A		100	4	1444	3.00		○	●	○	○	○	○	●

Note: Permissible continuous operating current is 100% at ambient temperature of 23°C (73.4°F)

Temperature Derating Curve

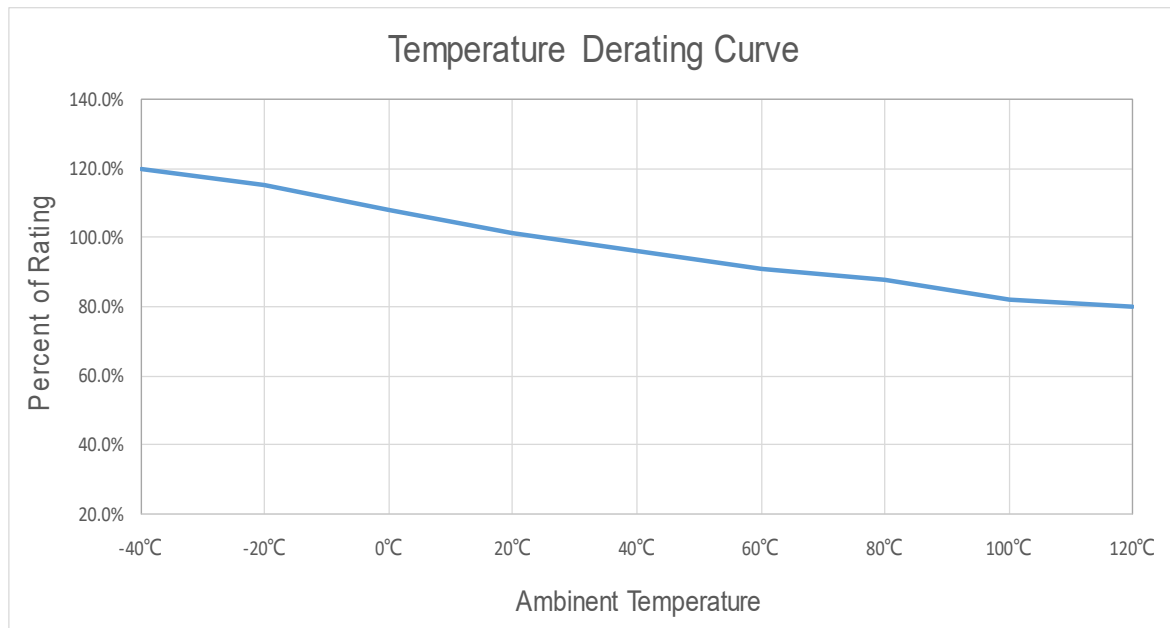

Calculation for ideal fuse selection =  $\frac{\text{Operating Current (A)}}{\text{Rating (\%} \times 0.75)}$



### 7.SOLDERING PARAMETERS

260°C.≤5 sec (Wave Soldering)

350°C.≤3 sec (Hand Soldering)

Soldering Peak:

260°C - 10 sec (IEC 60068-20)

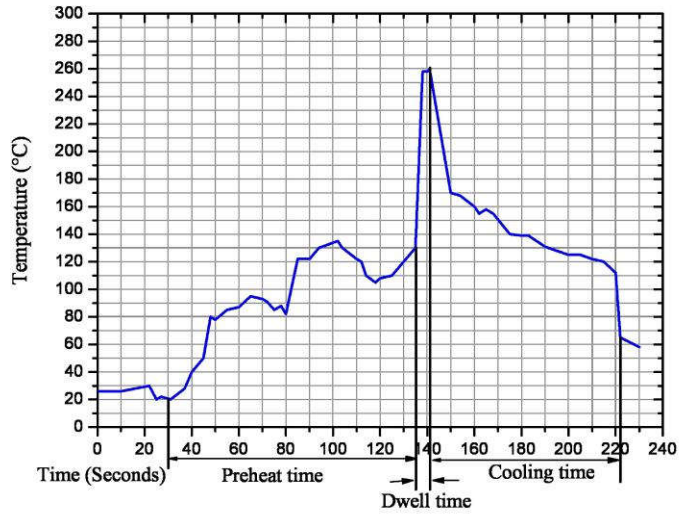

### 8.ORDERING INFORMATION

The following information are necessary in order to place your order with us correctly:

Series	Amp Code	Supplementary Code	Qty
522			





**9.PACKING INFORMATION**

**Packing details**

Plastic bag

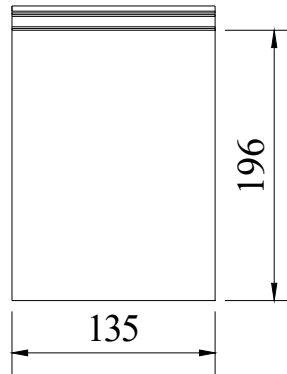

Inner Box

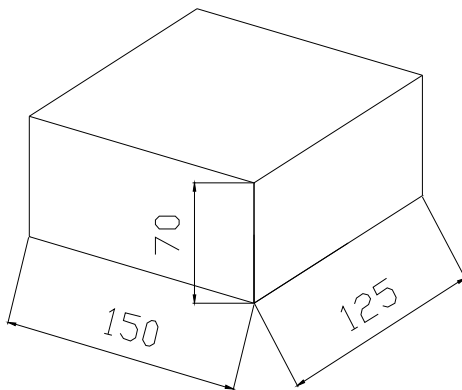

Master Carton

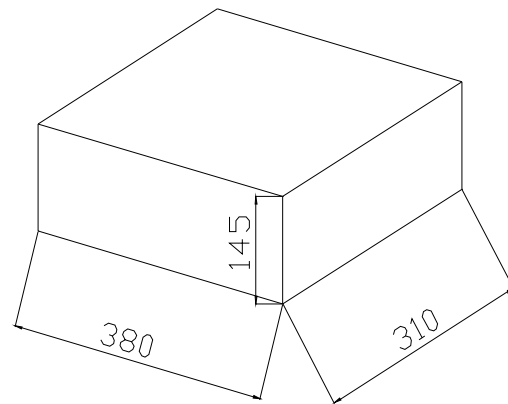

Net Weight (100pcs/bag)	415g	Inner box weight	880g	Master Carton Weight	9.7kg
Qty per bag	500pcs	Qty per box	1000pcs	Qty per carton	10000pcs

© Dongguan Better Electronics Technology Co., Ltd.

东莞市贝特电子科技股份有限公司

Room 601 of 16 Block, Xinzhu Yuan, No.4, Xinzhu Road, Songshanlake Hightech Industrial Development Zone, Dongguan City, Guangdong P.R.C  
中国广东省东莞市松山湖国家高新技术产业开发区新竹路4号新竹苑16座办公601

Tel: +86 769-2307 8212 Fax: +86 769-8352 1857

Web: [www.betterfuse.com](http://www.betterfuse.com)

Email: [info@betterfuse.com](mailto:info@betterfuse.com)



## 10. APPENDIX



# 产品认证证书

证书编号：CQC06012017150

## 申请人名称及地址

东莞市贝特电子科技股份有限公司  
东莞市松山湖高新技术产业开发区新竹路4号新竹苑16座办公601

## 制造商名称及地址

东莞市贝特电子科技股份有限公司  
东莞市松山湖高新技术产业开发区新竹路4号新竹苑16座办公601

## 生产企业名称及地址

东莞市贝特电子科技股份有限公司(V003591)  
东莞市寮步镇横坑南门村第二工业区C座、B座

## 产品名称和系列、规格、型号

特殊应用的小型熔断体(管状)  
522 12.5A a.c. 250V、522 16A a.c. 250V(额定分断能力：10In，主要尺寸：Φ5mm×20mm)

## 产品标准和技术要求

GB/T 9364.1-2015;GB/T 9364.7-2016

## 认证模式

产品型式试验+初次工厂检查+获证后监督

上述产品符合 CQC11-462125-2018 认证规则的要求，特发此证。

发证日期：2019年10月25日

本证书的有效性依据发证机构的定期监督获得保持。

本证书为变更证书，证书首次颁发日期：2006年08月15日

主任：\_\_\_\_\_

陆梅



## 中国质量认证中心

中国·北京·南四环西路188号9区100070

<http://www.cqc.com.cn>

C 0157246



# PRODUCT CERTIFICATE

CERTIFICATE NO.: CQC06012017150

## NAME AND ADDRESS OF THE APPLICANT

Dongguan Better Electronics Technology Co.,Ltd.  
Room 601 of 16 Block, Xinzhu Yuan, No. 4 Xinzhu Road, Songshanlake Hightech Industrial Development  
Zone, Dongguan City

## NAME AND ADDRESS OF THE MANUFACTURER

Dongguan Better Electronics Technology Co.,Ltd.  
Room 601 of 16 Block, Xinzhu Yuan, No. 4 Xinzhu Road, Songshanlake Hightech Industrial Development  
Zone, Dongguan City

## NAME AND ADDRESS OF THE FACTORY

Dongguan Better Electronics Technology Co.,Ltd. (V003591)  
NanMen Village, HengKen Administrative Zone LiaoBu Town, Dongguan, Guangdong, China.

## PRODUCT NAME, MODEL AND SPECIFICATION

Miniature Fuse-links for Special applications  
522 12.5A a.c. 250V、522 16A a.c. 250V(额定分断能力: 10In, 主要尺寸:Φ5mm×20mm)

## THE STANDARDS AND TECHNICAL REQUIREMENTS FOR THE PRODUCTS

GB/T 9364.1-2015;GB/T 9364.7-2016

## TYPE OF CERTIFICATION SCHEMES

Type Testing of Product + Initial Factory Inspection + Follow up Factory Inspection

This is to certify that the above mentioned product(s) complies with the requirements of certification  
rules of CQC11-462125-2018 .

Valid from: Oct.25,2019

The validity of the certificate is subject to positive result of the regular follow up inspection by issuing  
certification body.

Date of original issued: Aug.15,2006

President: \_\_\_\_\_

Lu Mei



## CHINA QUALITY CERTIFICATION CENTRE

Section 9, No.188, Nansihuan Xilu, Beijing 100070 P.R.China  
<http://www.cqc.com.cn>

C 0157246



# 产品认证证书

证书编号：CQC05012012795

## 申请人名称及地址

东莞市贝特电子科技股份有限公司  
东莞市松山湖高新技术产业开发区新竹路4号新竹苑16座办公601

## 制造商名称及地址

东莞市贝特电子科技股份有限公司  
东莞市松山湖高新技术产业开发区新竹路4号新竹苑16座办公601

## 生产企业名称及地址

东莞市贝特电子科技股份有限公司(V003591)  
东莞市寮步镇横坑南门村第二工业区C座、B座

## 产品名称和系列、规格、型号

特殊应用的小型熔断体(管状)  
522 8A a.c. 250V、522 10A a.c. 250V(额定分断能力：10In, 主要尺寸:Φ5mm×20mm)

## 产品标准和技术要求

GB/T 9364.1-2015;GB/T 9364.7-2016

## 认证模式

产品型式试验+初次工厂检查+获证后监督

上述产品符合 CQC11-462125-2018 认证规则的要求，特发此证。

发证日期：2019年11月18日

本证书的有效性依据发证机构的定期监督获得保持。

本证书为变更证书，证书首次颁发日期：2005年04月15日

主任：\_\_\_\_\_

陆梅



## 中国质量认证中心

中国·北京·南四环西路188号9区100070

<http://www.cqc.com.cn>

C 0154665



# PRODUCT CERTIFICATE

CERTIFICATE NO.: CQC05012012795

## NAME AND ADDRESS OF THE APPLICANT

Dongguan Better Electronics Technology Co.,Ltd.  
Room 601 of 16 Block, Xinzhu Yuan, No. 4 Xinzhu Road, Songshanlake Hightech Industrial Development  
Zone, Dongguan City

## NAME AND ADDRESS OF THE MANUFACTURER

Dongguan Better Electronics Technology Co.,Ltd.  
Room 601 of 16 Block, Xinzhu Yuan, No. 4 Xinzhu Road, Songshanlake Hightech Industrial Development  
Zone, Dongguan City

## NAME AND ADDRESS OF THE FACTORY

Dongguan Better Electronics Technology Co.,Ltd. (V003591)  
NanMen Village, HengKen Administrative Zone LiaoBu Town, Dongguan, Guangdong, China.

## PRODUCT NAME, MODEL AND SPECIFICATION

Miniature Fuse-links for Special applications  
522 8A a.c. 250V、522 10A a.c. 250V(额定分断能力: 10In, 主要尺寸:Φ5mm×20mm)

## THE STANDARDS AND TECHNICAL REQUIREMENTS FOR THE PRODUCTS

GB/T 9364.1-2015;GB/T 9364.7-2016

## TYPE OF CERTIFICATION SCHEMES

Type Testing of Product + Initial Factory Inspection + Follow up Factory Inspection

This is to certify that the above mentioned product(s) complies with the requirements of certification  
rules of CQC11-462125-2018 .

Valid from: Nov.18,2019

The validity of the certificate is subject to positive result of the regular follow up inspection by issuing  
certification body.

Date of original issued: Apr.15,2005

President: \_\_\_\_\_

Lu Mei



## CHINA QUALITY CERTIFICATION CENTRE

Section 9, No.188, Nansihuan Xilu, Beijing 100070 P.R.China  
<http://www.cqc.com.cn>

C 0154665

## ZEICHENGENEHMIGUNG MARKS APPROVAL

Dongguan Better Electronics  
Technology Co., Ltd.  
Room 601 of 16 Block, Xinzhu Yuan  
No 4, Xinzhu Road  
523808 DONGGUAN  
CHINA

ist berechtigt, für ihr Produkt /  
*is authorized to use for their product*

**G-Sicherungseinsatz**  
**Cartridge fuse-link**

die hier abgebildeten markenrechtlich geschützten Zeichen  
für die ab Blatt 2 aufgeführten Typen zu benutzen /  
*the legally protected Marks as shown below for the types referred to on page 2 ff.*



Geprüft und zertifiziert nach /  
*Tested and certified according to*

DIN EN 60127-1 (VDE 0820-1):2015-12; EN 60127-1:2006+A1:2011+A2:2015  
DIN EN 60127-2 (VDE 0820-2):2015-07; EN 60127-2:2014  
IEC 60127-1:2006  
IEC 60127-1:2006/AMD1:2011  
IEC 60127-1:2006/AMD2:2015  
IEC 60127-2:2014



Aktenzeichen: 5015514-1170-0001 / 228704

File ref.:

Ausweis-Nr. 40019022

Blatt 1

Certificate No.

Page

Weitere Bedingungen siehe Rückseite und Folgeblätter /  
further conditions see overleaf and following pages

Offenbach, 2006-09-29

(letzte Änderung / updated 2016-11-16 )

VDE Prüf- und Zertifizierungsinstitut GmbH  
VDE Testing and Certification Institute  
Zertifizierungsstelle / Certification

M. Tasotti

VDE Zertifikate sind nur gültig bei Veröffentlichung unter:  
VDE certificates are valid only when published on:

<http://www.vde.com/zertifikat>  
<http://www.vde.com/certificate>

Name und Sitz des Genehmigungs-Inhabers / *Name and registered seat of the Certificate holder*

Dongguan Better Electronics Technology Co., Ltd., Room 601 of 16 Block, Xinzhu Yuan, No 4, Xinzhu Road,  
523808 DONGGUAN, Guangdong, CHINA

Aktenzeichen / *File ref.*

5015514-1170-0001 / 228704 / CC2 / EUL

letzte Änderung / *updated*

2016-11-16

Datum / *Date*

2006-09-29

Dieses Blatt gilt nur in Verbindung mit Blatt 1 des Zeichengenehmigungsausweises Nr. 40019022.

*This supplement is only valid in conjunction with page 1 of the Certificate No. 40019022.*

## G-Sicherungseinsatz Cartridge fuse-link

Typ(en) / *Type(s)*

### 522

Bemessungsspannung <i>Rated voltage</i>	AC 250 V
Bemessungsstrom <i>Rated current</i>	500 mA; 1 A; 1,6 A; 2 A; 2,5 A 3,15 A; 4 A; 5 A; 6,3 A; 8 A; 10 A
Normblatt <i>Standard sheet</i>	3
Maße in mm <i>Dimension in mm</i>	5 x 20
Kennzeichnung der Charakteristik <i>Characteristic symbol</i>	T
Kennzeichnung des Ausschaltvermögens <i>Breaking capacity symbol</i>	L
Bemessungsausschaltvermögen <i>Rated breaking capacity</i>	35 A bzw. 10 x In 35 A resp. 10 x In
Zeit/Strom-Charakteristik <i>Time/current-characteristic</i>	träge time-lag

Fortsetzung siehe Blatt 3 /  
*continued on page 3*



Name und Sitz des Genehmigungs-Inhabers / *Name and registered seat of the Certificate holder*

Dongguan Better Electronics Technology Co., Ltd., Room 601 of 16 Block, Xinzhu Road,  
523808 DONGGUAN, Guangdong, CHINA

Aktenzeichen / *File ref.*

5015514-1170-0001 / 228704 / CC2 / EUL

letzte Änderung / *updated*

2016-11-16

Datum / *Date*

2006-09-29

Dieses Blatt gilt nur in Verbindung mit Blatt 1 des Zeichengenehmigungsausweises Nr. 40019022.

*This supplement is only valid in conjunction with page 1 of the Certificate No. 40019022.*

Anmerkung

*Remark*

Die Prüfspannung in Abschnitt 9.2 war DC 125 V

*The test voltage in clause 9.2 was DC 125 V*

Dieser Zeichengenehmigungs-Ausweis bildet eine Grundlage für die EG-Konformitätserklärung und CE-Kennzeichnung durch den Hersteller oder dessen Bevollmächtigten und bescheinigt die Konformität mit den grundlegenden Schutzanforderungen der **EG-Niederspannungsrichtlinie 2014/35/EU**.

*This Marks Approval is a basis for the EC Declaration of Conformity and the CE Marking by the manufacturer or his agent and proves the conformity with the essential safety requirements of the **EC Low-Voltage Directive 2014/35/EU**.*

VDE Prüf- und Zertifizierungsinstitut GmbH

*VDE Testing and Certification Institute*

Fachgebiet CC2

*Section CC2*

# VDE Prüf- und Zertifizierungsinstitut Zeichengenehmigung

Ausweis-Nr. / Beiblatt /  
Certificate No. Supplement  
40019022

Name und Sitz des Genehmigungs-Inhabers / *Name and registered seat of the Certificate holder*

Dongguan Better Electronics Technology Co., Ltd., Room 601 of 16 Block, Xinzhu Road,  
523808 DONGGUAN, Guangdong, CHINA

Aktenzeichen / *File ref.*

5015514-1170-0001 / 228704 / CC2 / EUL

letzte Änderung / *updated*

2016-11-16

Datum / *Date*

2006-09-29

Dieses Beiblatt ist Bestandteil des Zeichengenehmigungsausweises Nr. 40019022.

*This supplement is part of the Certificate No. 40019022.*

## G-Sicherungseinsatz Cartridge fuse-link

Fertigungsstätte(n)

*Place(s) of manufacture*

Referenz/*Reference*  
**30017543**

Dongguan Better Electronics  
Technology Co., Ltd.  
Nanmen Village  
Hengkeng Administrative Zone  
523413 LIAOBU TOWN, DONGGUAN  
Guangdong  
CHINA

VDE Prüf- und Zertifizierungsinstitut GmbH

*VDE Testing and Certification Institute*

Fachgebiet CC2

*Section CC2*

Name und Sitz des Genehmigungs-Inhabers / *Name and registered seat of the Certificate holder*

Dongguan Better Electronics Technology Co., Ltd., Room 601 of 16 Block, Xinzhu Road,  
523808 DONGGUAN, Guangdong, CHINA

Aktenzeichen / *File ref.*

5015514-1170-0001 / 228704 / CC2 / EUL

letzte Änderung / *updated*

2016-11-16

Datum / *Date*

2006-09-29

Dieses Blatt gilt nur in Verbindung mit Blatt 1 des Zeichengenehmigungsausweises Nr. 40019022.

*This supplement is only valid in conjunction with page 1 of the Certificate No. 40019022.*

## **Genehmigung zum Benutzen des auf Seite 1 abgebildeten markenrechtlich geschützten Zeichens des VDE:**

Grundlage für die Benutzung sind die Allgemeinen Geschäftsbedingungen (AGB) der VDE Prüf- und Zertifizierungsinstitut GmbH ([www.vde.com\AGB-Institut](http://www.vde.com\AGB-Institut)). Das Recht zur Benutzung erstreckt sich nur auf die bezeichnete Firma mit den genannten Fertigungsstätten und die oben aufgeführten Produkte mit den zugeordneten Bezeichnungen. Die Fertigungsstätte muss so eingerichtet sein, dass eine gleichmäßige Herstellung der geprüften und zertifizierten Ausführung gewährleistet ist.

Die Genehmigung ist so lange gültig wie die VDE-Bestimmungen gelten, die der Zertifizierung zugrunde gelegen haben, sofern sie nicht auf Grund anderer Bedingungen aus der VDE Prüf- und Zertifizierungsordnung (PM102) zurückgezogen werden muss.

Der Gültigkeitszeitraum einer VDE-GS-Zeichengenehmigung kann auf Antrag verlängert werden. Bei gesetzlichen und / oder normativen Änderungen kann die VDE-GS-Zeichengenehmigung ihre Gültigkeit zu einem früheren als dem angegebenen Datum verlieren.

Produkte, die das Biozid Dimethylfumarat (DMF) enthalten, dürfen gemäß der Kommissionsentscheidung 2009/251/EG nicht mehr in den Verkehr gebracht oder auf dem Markt bereitgestellt werden.

Der VDE-Zeichengenehmigungsausweis wird ausschließlich auf der ersten Seite unterzeichnet.

### **Approval to use the legally protected Mark of the VDE as shown on the first page:**

*Basis for the use are the general terms and conditions of the VDE Testing and Certification Institute ([www.vde.com\terms-institute](http://www.vde.com\terms-institute)). The right to use the mark is granted only to the mentioned company with the named places of manufacture and the listed products with the related type references. The place of manufacture shall be equipped in a way that a constant manufacturing of the certified construction is assured.*

*The approval is valid as long as the VDE specifications are in force, on which the certification is based on, unless it is withdrawn according to the VDE Testing and Certification Procedure (PM102E).*

*The validity period of a VDE-GS-Mark Approval may be prolonged on request. In case of changes in legal and / or normative requirements, the validity period of a VDE-GS-Mark Approval may be shortened.*

*Products containing the biocide dimethylfumarate (DMF) may not be marketed or made available on the EC market according to the Commission Decision 2009/251/EC.*

*The approval is solely signed on the first page.*

## GUTACHTEN MIT FERTIGUNGSÜBERWACHUNG CERTIFICATE OF CONFORMITY WITH FACTORY SURVEILLANCE

Dongguan Better Electronics  
Technology Co., Ltd.  
Room 601 of 16 Block, Xinzhu Yuan  
No 4, Xinzhu Road  
523808 DONGGUAN  
CHINA

ist berechtigt, für ihr Produkt /  
is authorized to use for their product

**G-Sicherungseinsatz**  
**Cartridge fuse-link**

die hier abgebildeten markenrechtlich geschützten Zeichen  
für die ab Blatt 2 aufgeführten Typen zu benutzen /  
the legally protected Marks as shown below for the types referred to on page 2 ff.



REG.-Nr. E781 oder/or



oder/or VDE-REG.-Nr. E781

REG.-Nr. E781

Geprüft und zertifiziert nach /  
Tested and certified according to

DIN EN 60127-1 (VDE 0820-1):2015-12; EN 60127-1:2006+A1:2011+A2:2015  
DIN EN 60127-2 (VDE 0820-2):2015-07; EN 60127-2:2014  
IEC 60127-1:2006  
IEC 60127-1:2006/AMD1:2011  
IEC 60127-1:2006/AMD2:2015  
IEC 60127-2:2014



Aktenzeichen: 5015514-1170-0001 / 228750

File ref.:

Ausweis-Nr. 40042731

Blatt 1

Certificate No.

Page

Weitere Bedingungen siehe Rückseite und Folgeblätter /  
further conditions see overleaf and following pages

Offenbach, 2015-07-29

(letzte Änderung / updated 2016-11-16)

VDE Prüf- und Zertifizierungsinstitut GmbH  
VDE Testing and Certification Institute  
Zertifizierungsstelle / Certification

M. Tesotti

VDE Zertifikate sind nur gültig bei Veröffentlichung unter:  
VDE certificates are valid only when published on:

<http://www.vde.com/zertifikat>  
<http://www.vde.com/certificate>

Name und Sitz des Genehmigungs-Inhabers / *Name and registered seat of the Certificate holder*

Dongguan Better Electronics Technology Co., Ltd., Room 601 of 16 Block, Xinzhu Road,  
523808 DONGGUAN, Guangdong, CHINA

Aktenzeichen / *File ref.*

5015514-1170-0001 / 228750 / CC2 / EUL

letzte Änderung / *updated*

2016-11-16

Datum / *Date*

2015-07-29

Dieses Blatt gilt nur in Verbindung mit Blatt 1 des Gutachtens mit Fertigungsüberwachung Nr. 40042731.

*This supplement is only valid in conjunction with page 1 of the Certificate of Conformity with factory surveillance No. 40042731.*

## G-Sicherungseinsatz Cartridge fuse-link

Typ(en) / *Type(s)*

### 522

Bemessungsspannung  
*Rated voltage* AC 250 V

Bemessungsstrom  
*Rated current* 12,5 A

Normblatt  
*Standard sheet* 3

Maße in mm  
*Dimension in mm* 5 x 20

Kennzeichnung der Charakteristik  
*Characteristic symbol* T

Kennzeichnung des Ausschaltvermögens  
*Breaking capacity symbol* L

Bemessungsausschaltvermögen  
*Rated breaking capacity* 10 x I<sub>n</sub>

Zeit/Strom-Charakteristik  
*Time/current-characteristic* trträge  
*time-lag*

Fortsetzung siehe Blatt 3 /  
*continued on page 3*

# VDE Prüf- und Zertifizierungsinstitut Gutachten mit Fertigungsüberwachung

Ausweis-Nr. / Blatt /  
Certificate No. / Page  
40042731 / 3

Name und Sitz des Genehmigungs-Inhabers / *Name and registered seat of the Certificate holder*

Dongguan Better Electronics Technology Co., Ltd., Room 601 of 16 Block, Xinzhu Road,  
523808 DONGGUAN, Guangdong, CHINA

Aktenzeichen / *File ref.*

5015514-1170-0001 / 228750 / CC2 / EUL

letzte Änderung / *updated*

2016-11-16

Datum / *Date*

2015-07-29

Dieses Blatt gilt nur in Verbindung mit Blatt 1 des Gutachtens mit Fertigungsüberwachung Nr. 40042731.

*This supplement is only valid in conjunction with page 1 of the Certificate of Conformity with factory surveillance No. 40042731.*

Anmerkung

*Remark*

Die Prüfspannung in Abschnitt 9.2 war DC 125 V

*The test voltage in clause 9.2 was DC 125 V*

---

Dieser Zeichengenehmigungs-Ausweis bildet eine Grundlage für die EG-Konformitätserklärung und CE-Kennzeichnung durch den Hersteller oder dessen Bevollmächtigten und bescheinigt die Konformität mit den grundlegenden Schutzanforderungen der **EG-Niederspannungsrichtlinie 2014/35/EU**.

*This Marks Approval is a basis for the EC Declaration of Conformity and the CE Marking by the manufacturer or his agent and proves the conformity with the essential safety requirements of the **EC Low-Voltage Directive 2014/35/EU**.*

VDE Prüf- und Zertifizierungsinstitut GmbH

*VDE Testing and Certification Institute*

Fachgebiet CC2

*Section CC2*

# VDE Prüf- und Zertifizierungsinstitut Gutachten mit Fertigungsüberwachung

Ausweis-Nr. / Beiblatt /  
Certificate No. Supplement  
40042731

Name und Sitz des Genehmigungs-Inhabers / *Name and registered seat of the Certificate holder*

Dongguan Better Electronics Technology Co., Ltd., Room 601 of 16 Block, Xinzhu Yuan, No 4, Xinzhu Road,  
523808 DONGGUAN, Guangdong, CHINA

Aktenzeichen / *File ref.*

5015514-1170-0001 / 228750 / CC2 / EUL

letzte Änderung / *updated*

2016-11-16

Datum / *Date*

2015-07-29

Dieses Beiblatt ist Bestandteil des Gutachtens mit Fertigungsüberwachung Nr. 40042731.

*This supplement is part of the Certificate of Conformity with factory surveillance No. 40042731.*

## G-Sicherungseinsatz Cartridge fuse-link

### Fertigungsstätte(n) Place(s) of manufacture

Referenz/*Reference*  
**30017543**

Dongguan Better Electronics  
Technology Co., Ltd.  
Nanmen Village  
Hengkeng Administrative Zone  
523413 LIAOBU TOWN, DONGGUAN  
Guangdong  
CHINA

VDE Prüf- und Zertifizierungsinstitut GmbH  
*VDE Testing and Certification Institute*  
Fachgebiet CC2  
*Section CC2*

Name und Sitz des Genehmigungs-Inhabers / *Name and registered seat of the Certificate holder*

Dongguan Better Electronics Technology Co., Ltd., Room 601 of 16 Block, Xinzhu Road,  
523808 DONGGUAN, Guangdong, CHINA

Aktenzeichen / *File ref.*

5015514-1170-0001 / 228750 / CC2 / EUL

letzte Änderung / *updated*

2016-11-16

Datum / *Date*

2015-07-29

Dieses Blatt gilt nur in Verbindung mit Blatt 1 des Gutachtens mit Fertigungsüberwachung Nr. 40042731.

*This supplement is only valid in conjunction with page 1 of the Certificate of Conformity with factory surveillance No. 40042731.*

## **Genehmigung zum Benutzen des auf Seite 1 abgebildeten markenrechtlich geschützten Zeichens des VDE:**

Grundlage für die Benutzung sind die Allgemeinen Geschäftsbedingungen (AGB) der VDE Prüf- und Zertifizierungsinstitut GmbH ([www.vde.com\AGB-Institut](http://www.vde.com\AGB-Institut)). Das Recht zur Benutzung erstreckt sich nur auf die bezeichnete Firma mit den genannten Fertigungsstätten und die oben aufgeführten Produkte mit den zugeordneten Bezeichnungen. Die Fertigungsstätte muss so eingerichtet sein, dass eine gleichmäßige Herstellung der geprüften und zertifizierten Ausführung gewährleistet ist.

Die Genehmigung ist so lange gültig wie die VDE-Bestimmungen gelten, die der Zertifizierung zugrunde gelegen haben, sofern sie nicht auf Grund anderer Bedingungen aus der VDE Prüf- und Zertifizierungsordnung (PM102) zurückgezogen werden muss.

Der Gültigkeitszeitraum einer VDE-GS-Zeichengenehmigung kann auf Antrag verlängert werden. Bei gesetzlichen und / oder normativen Änderungen kann die VDE-GS-Zeichengenehmigung ihre Gültigkeit zu einem früheren als dem angegebenen Datum verlieren.

Produkte, die das Biozid Dimethylfumarat (DMF) enthalten, dürfen gemäß der Kommissionsentscheidung 2009/251/EG nicht mehr in den Verkehr gebracht oder auf dem Markt bereitgestellt werden.

Der VDE-Zeichengenehmigungsausweis wird ausschließlich auf der ersten Seite unterzeichnet.

### **Approval to use the legally protected Mark of the VDE as shown on the first page:**

*Basis for the use are the general terms and conditions of the VDE Testing and Certification Institute ([www.vde.com\terms-institute](http://www.vde.com\terms-institute)). The right to use the mark is granted only to the mentioned company with the named places of manufacture and the listed products with the related type references. The place of manufacture shall be equipped in a way that a constant manufacturing of the certified construction is assured.*

*The approval is valid as long as the VDE specifications are in force, on which the certification is based on, unless it is withdrawn according to the VDE Testing and Certification Procedure (PM102E).*

*The validity period of a VDE-GS-Mark Approval may be prolonged on request. In case of changes in legal and / or normative requirements, the validity period of a VDE-GS-Mark Approval may be shortened.*

*Products containing the biocide dimethylfumarate (DMF) may not be marketed or made available on the EC market according to the Commission Decision 2009/251/EC.*

*The approval is solely signed on the first page.*



**Zertifikat**  
mit überwachter Konformität

**Certificate**  
of surveyed conformity



Zertifikat Nr. *Certificate No.*  
J 50415641

Blatt *Sheet*  
0001

<b>Ihr Zeichen</b> <i>Client Reference</i>	<b>Unser Zeichen</b> <i>Our Reference</i>	<b>Ausstellungsdatum</b>	<b>Date of Issue</b>
	05-YFC-50158206 001	15.08.2018	(day/mo/yr)

**Genehmigungsinhaber** *License Holder*  
Dongguan Better Electronics  
Technology Co., Ltd.  
Room 601 of 16 Block, Xinzhu Yuan  
No 4, Xinzhu Road, Songshanlake  
Hightech Ind. Development Zone  
Dongguan City, Guangdong Province  
P. R. China

**Fertigungsstätte** *Manufacturing Plant*  
Dongguan Better Electronics  
Technology Co., Ltd.  
Nanmen Village, Hengkeng  
Administrative Zone, Liaobu Town  
Dongguan, Guangdong  
P. R. China

**Prüfzeichen** *Test Mark*



**Geprüft nach** *Tested acc. to*  
EN 60127-1:2006+A1+A2  
EN 60127-2:2014

**Zertifiziertes Produkt (Geräteidentifikation)**  
*Certified Product (Product Identification)*

**Lizenzentgelte - Einheit**  
*License Fee - Unit*

(Cartridge Fuse-links)

Type Designation : 522  
Trademark : Better (Logo)  
Rated Voltage : AC 250V  
Rated Current : 250mA; 315mA; 400mA; 1,25A; 12A;  
15A; 16A  
T/I Characteristic : T  
Rated Breaking Capacity: 35A or 10In, whichever is greater  
Dimension : 5mmx20mm

6

**Remark:**

The labelling requirements according to EU Directive 2001/95 have to be observed for distribution within the EEA. The installation has to be carried out according to installation instruction accompanying the products.

6

**ANLAGE (Appendix): 1**

Dem Zertifikat liegt unsere Prüf- und Zertifizierungsordnung zugrunde.  
Das Produkt entspricht den o.g. Anforderungen, die Herstellung wird überwacht.  
This certificate is based on our Testing and Certification Regulation. The product fulfills above mentioned requirements, the production is subject to surveillance.

**TÜV Rheinland LGA Products GmbH, Tillystraße 2, 90431 Nürnberg**

Tel.: +49 221 806-1371 e-mail: cert-validity@de.tuv.com  
Fax: +49 221 806-3935 http://www.tuv.com/safety





# 適合証明書

Certificate of Conformity

証明書番号 Certificate No.  
PSE15020944

申請者照会番号 Applicant Reference  
CJP2015102003-1190

発行年月日 Date of Issue  
2015年11月24日

申請者 Applicant  
DONGGUAN BETTER ELECTRONICS  
TECHNOLOGY CO.,LTD  
ROOM 601 OF 16 BLOCK, XINZHUYUAN, NO 4,  
XINZHU ROAD, SONGSHANLAKE HIGHTECH  
INDUSTRIAL DEVELOPMENT ZONE, DONGGUAN  
CITY, GUANGDONG PROVINCE, P.R.CHINA 523808

製造工場 Factory  
DONGGUAN BETTER ELECTRONICS  
TECHNOLOGY CO.,LTD  
NANMEN VILLAGE, HENKENG  
ADMINISTRATIVE ZONE LIAOBU TOWN,  
DONGGUAN, GUANGDONG, P.R.CHINA 523413



検査の方法 Standard for Certificate

- 電気用品の技術基準の解釈 別表第十二 国際規格等に準拠した基準  
J60127-1(H26); J60127-2(H26)
- 施行規則別表第四  
Appendix 4 of the Enforcement Regulations

特定電気用品名 :  
Name of Specified Electrical  
Appliance and Material

管形ヒューズ  
Cartridge fuse

型式の区分 :  
Type Classification

(「添付書類」参照)  
(Refer to Attachment)

モデル名 :

522 T1AL250V, 522 T1.6AL250V, 522 T2AL250V, 522 T2.5AL250V,  
522 T3.15AL250V, 522 T4AL250V, 522 T5AL250V

Model

製造事業者 :  
Manufacturer

DONGGUAN BETTER ELECTRONICS TECHNOLOGY CO.,LTD

証明書の有効期間 :  
Validity of Certificate

2022年11月23日まで有効です。  
This certificate is expired on Nov. 23rd, 2022

これは、上記申請者より申請のあった上記特定電気用品及び製造工場が、電気用品安全法第八条第一項に規定する技術基準及び同法第九条第二項の経済産業省令で定める基準に適合していることを証明するものです。

This is to certify that the above-mentioned Specified Electrical Appliances and Materials and the factory which the above-mentioned applicant applied for have been complied with the Technical Requirements stipulated by Article 8, Paragraph 1 of the Electrical Appliance and Material Safety Law and the requirements stipulated by the METI Ordinance specified in Article 9, paragraph 2 of the said law.

中国品質認証センター  
CHINA QUALITY  
CERTIFICATION CENTRE

氏名  
Name

発行者  
Issued by



中国100070北京市南四環西路188号9区  
Section 9, No.188, Nansihuan Xilu, Beijing 100070, China

PJ 0004167



# 適合証明書

Certificate of Conformity

添付書類 Attachment 1

証明書番号(Certificate No.):  
PSE15020944

発行日 Date of Issue :  
2015年11月24日

## 【 型式の区分 Type Classification 】

特定電気用品 :  
(Name of Specified Electrical Appliance and Material)

管形ヒューズ  
Cartridge fuse

要素	区分
定格電圧	(1) 125V以下のもの (2) 125Vを超えるもの
定格電流 (定格電流表示のあるものの場合に限る。)	(1) 5A以下のもの (2) 5Aを超え15A以下のもの (3) 15Aを超え30A以下のもの (4) 30Aを超え60A以下のもの (5) 60Aを超え100A以下のもの (6) 100Aを超えるもの
適用電動機の定格容量 (定格電流表示のないものの場合に限る。)	(1) 単相で200W以下のもの (2) 単相で200Wを超え400W以下のもの (3) 単相で400Wを超え750W以下のもの (4) 単相で750Wを超えるもの (5) 3相で750W以下のもの (6) 3相で750Wを超え2.2kW以下のもの (7) 3相で2.2kWを超え3.7kW以下のもの (8) 3相で3.7kWを超え7.5kW以下のもの (9) 3相で7.5kWを超えるもの
可溶体の主材料	(1) 銀のもの (2) アルミニウムのもの (3) 亜鉛のもの (4) 鉛のもの (5) 銅のもの (6) その他のもの

中国品質認証センター  
CHINA QUALITY  
CERTIFICATION CENTRE

氏名  
Name

発行者  
Issued by



中国100070北京市南四環西路188号9区

Section 9, No.188, Nansihuan Xilu, Beijing 100070, China



# 適合証明書

Certificate of Conformity

添付書類 Attachment 2

証明書番号(Certificate No.):  
PSE15020944

発行日 Date of Issue :  
2015年11月24日

## 【型式の区分 Type Classification】

特定電気用品 :  
(Name of Specified Electrical Appliance and Material)

管形ヒューズ  
Cartridge fuse

可溶体の数	(1) 1のもの (2) 2以上のもの
再使用 (管形ヒューズを除く。)	(1) できるもの (2) できないもの
内部充てん物	(1) あるもの (2) ないもの
筒 (内筒を除く。) の材料	(1) フェノール樹脂のもの (2) ファイバーのもの (3) 磁器のもの又はガラスのもの (4) ポリエステル樹脂のもの (5) メラミン樹脂のもの (6) ユリア樹脂のもの (7) その他のもの
端子	(1) 刃形のもの (2) 筒形のもの (3) 締付け形のもの (4) リード線付きのもの (5) その他のもの
排気孔	(1) あるもの (2) ないもの
溶断の表示	(1) あるもの (2) ないもの
用途	(1) 電動機用のもの (2) 電子機器用のもの (3) 短絡保護専用のもの (4) その他のもの

中国品質認証センター  
CHINA QUALITY  
CERTIFICATION CENTRE

氏名  
Name

発行者  
Issued by



中国100070北京市南四环西路188号9区

Section 9, No.188, Nansihuan Xilu, Beijing 100070, China



# 適合証明書

Certificate of Conformity

添付書類 Attachment 3

証明書番号(Certificate No.):  
PSE15020944

発行日 Date of Issue :  
2015年11月24日

## 【 型式の区分 Type Classification 】

特定電気用品 :  
(Name of Specified Electrical Appliance and Material)

管形ヒューズ  
Cartridge fuse

定格遮断電流	(1)	100A以下のもの
	(2)	100Aを超え300A以下のもの
	(3)	300Aを超え500A以下のもの
	(4)	500Aを超え1,000A以下のもの
	(5)	1,000Aを超え1,500A以下のもの
	(6)	1,500Aを超え2,500A以下のもの
	(7)	2,500Aを超え5,000A以下のもの
	(8)	5,000Aを超え7,500A以下のもの
	(9)	7,500Aを超え10,000A以下のもの
	(10)	10,000Aを超え15,000A以下のもの
	(11)	15,000Aを超え20,000A以下のもの
	(12)	20,000Aを超え25,000A以下のもの
	(13)	25,000Aを超え30,000A以下のもの
	(14)	30,000Aを超えるもの

中国品質認証センター  
CHINA QUALITY  
CERTIFICATION CENTRE

氏名  
Name

発行者  
Issued by



中国100070北京市南四環西路188号9区  
Section 9, No.188, Nansihuan Xilu, Beijing 100070, China



# 適合証明書

証明書番号 Certificate No.

PSE15020936

Certificate of Conformity

申請者照会番号 Applicant Reference

CJP2015102003-1193

発行年月日 Date of Issue

2015年11月18日

申請者 Applicant

DONGGUAN BETTER ELECTRONICS

TECHNOLOGY CO.,LTD

ROOM 601 OF 16 BLOCK, XINZHUYUAN, NO 4,

XINZHU ROAD, SONGSHANLAKE HIGHTECH

INDUSTRIAL DEVELOPMENT ZONE,

DONGGUAN CITY, GUANGDONG PROVINCE,

P.R.CHINA 523808

製造工場 Factory

DONGGUAN BETTER ELECTRONICS

TECHNOLOGY CO.,LTD

NANMEN VILLAGE, HENGKENG

ADMINISTRATIVE ZONE LIAOBU TOWN,

DONGGUAN, GUANGDONG, P.R.CHINA 523413



検査の方法 Standard for Certificate

- 電気用品の技術基準の解釈 別表第十二 国際規格等に準拠した基準  
J60127-1(H26); J60127-2(H26)

- 施行規則別表第四

Appendix 4 of the Enforcement Regulations

特定電気用品名:

Name of Specified Electrical  
Appliance and Material

型式の区分:

Type Classification

モデル名:

Model

製造事業者:

Manufacturer

証明書の有効期間:

Validity of Certificate

管形ヒューズ

Cartridge fuse

(「添付書類」参照)

(Refer to Attachment)

522 T6.3AL250V

DONGGUAN BETTER ELECTRONICS TECHNOLOGY CO.,LTD

2022年11月17日までに有効です。

This certificate is expired on Nov. 17th, 2022

これは、上記申請者より申請のあった上記特定電気用品及び製造工場が、電気用品安全法第八条第一項に規定する技術基準及び同法第九条第二項の経済産業省令で定める基準に適合していることを証明するものです。

This is to certify that the above-mentioned Specified Electrical Appliances and Materials and the factory which the above-mentioned applicant applied for have been complied with the Technical Requirements stipulated by Article 8, Paragraph 1 of the Electrical Appliance and Material Safety Law and the requirements stipulated by the METI Ordinance specified in Article 9, paragraph 2 of the said law.

中国品質認証センター  
CHINA QUALITY  
CERTIFICATION CENTRE

氏名  
Name

発行者  
Issued by



中国100070北京市南四环西路188号9区

Section 9, No.188, Nansihuan Xilu, Beijing 100070, China

PJ 0004148



# 適合証明書

Certificate of Conformity

添付書類 Attachment 1

証明書番号(Certificate No.):  
PSE15020936

発行日 Date of Issue:  
2015年11月18日

## 【型式の区分 Type Classification】

特定電気用品:  
(Name of Specified Electrical Appliance and Material)

管形ヒューズ  
Cartridge fuse

要素	区分
定格電圧	(1) 125V以下のもの (2) 125Vを超えるもの
定格電流 (定格電流表示のあるものの場合に限る。)	(1) 5A以下のもの (2) 5Aを超え15A以下のもの (3) 15Aを超え30A以下のもの (4) 30Aを超え60A以下のもの (5) 60Aを超え100A以下のもの (6) 100Aを超えるもの
適用電動機の定格容量 (定格電流表示のないものの場合に限る。)	(1) 単相で200W以下のもの (2) 単相で200Wを超え400W以下のもの (3) 単相で400Wを超え750W以下のもの (4) 単相で750Wを超えるもの (5) 3相で750W以下のもの (6) 3相で750Wを超え2.2kW以下のもの (7) 3相で2.2kWを超え3.7kW以下のもの (8) 3相で3.7kWを超え7.5kW以下のもの (9) 3相で7.5kWを超えるもの
可溶体の主材料	(1) 銀のもの (2) アルミニウムのもの (3) 亜鉛のもの (4) 鉛のもの (5) 銅のもの (6) その他のもの

中国品質認証センター  
CHINA QUALITY  
CERTIFICATION CENTRE

氏名  
Name

発行者  
Issued by



中国100070北京市南四環西路188号9区  
Section 9, No.188, Nansihuan Xilu, Beijing 100070, China



# 適合証明書

Certificate of Conformity

添付書類 Attachment 2

証明書番号(Certificate No.):  
PSE15020936

発行日 Date of Issue :  
2015年11月18日

## 【 型式の区分 Type Classification 】

特定電気用品 :  
(Name of Specified Electrical Appliance and Material)

管形ヒューズ  
Cartridge fuse

可溶体の数	(1) 1のもの (2) 2以上のもの
再使用 (管形ヒューズを除く。)	(1) できるもの (2) できないもの
内部充てん物	(1) あるもの (2) ないもの
筒 (内筒を除く。) の材料	(1) フェノール樹脂のもの (2) ファイバーのもの (3) 磁器のもの又はガラスのもの (4) ポリエステル樹脂のもの (5) メラミン樹脂のもの (6) ユリア樹脂のもの (7) その他のもの
端子	(1) 刃形のもの (2) 筒形のもの (3) 締付け形のもの (4) リード線付きのもの (5) その他のもの
排気孔	(1) あるもの (2) ないもの
溶断の表示	(1) あるもの (2) ないもの
用途	(1) 電動機用のもの (2) 電子機器用のもの (3) 短絡保護専用のもの (4) その他のもの

中国品質認証センター  
CHINA QUALITY  
CERTIFICATION CENTRE

氏名  
Name

発行者  
Issued by



中国100070北京市南四环西路188号9区

Section 9, No.188, Nansihuan Xilu, Beijing 100070, China





# 適合証明書

Certificate of Conformity

添付書類 Attachment 3

証明書番号(Certificate No.) :  
PSE15020936

発行日 Date of Issue :  
2015年11月18日

## 【 型式の区分 Type Classification 】

特定電気用品 :  
(Name of Specified Electrical Appliance and Material)

管形ヒューズ  
Cartridge fuse

定格遮断電流	<ul style="list-style-type: none"> <li>(1) 100A以下のもの</li> <li>(2) 100Aを超え300A以下のもの</li> <li>(3) 300Aを超え500A以下のもの</li> <li>(4) 500Aを超え1,000A以下のもの</li> <li>(5) 1,000Aを超え1,500A以下のもの</li> <li>(6) 1,500Aを超え2,500A以下のもの</li> <li>(7) 2,500Aを超え5,000A以下のもの</li> <li>(8) 5,000Aを超え7,500A以下のもの</li> <li>(9) 7,500Aを超え10,000A以下のもの</li> <li>(10) 10,000Aを超え15,000A以下のもの</li> <li>(11) 15,000Aを超え20,000A以下のもの</li> <li>(12) 20,000Aを超え25,000A以下のもの</li> <li>(13) 25,000Aを超え30,000A以下のもの</li> <li>(14) 30,000Aを超えるもの</li> </ul>
--------	--

中国品質認証センター  
CHINA QUALITY  
CERTIFICATION CENTRE

氏名  
Name

発行者  
Issued by



中国100070北京市南四環西路188号9区

Section 9, No.188, Nansihuan Xilu, Beijing 100070, China



# 適合証明書

証明書番号 Certificate No.

PSE15020906

Certificate of Conformity

申請者照会番号 Applicant Reference

CJP2015102003-1111

発行年月日 Date of Issue

2015年7月21日

申請者 Applicant

DONGGUAN BETTER ELECTRONICS

TECHNOLOGY CO.,LTD

ROOM 601 OF 16 BLOCK, XINZHUYUAN, NO 4,

XINZHU ROAD, SONGSHANLAKE HIGHTECH

INDUSTRIAL DEVELOPMENT ZONE,

DONGGUAN CITY, GUANGDONG PROVINCE,

P.R.CHINA 523808

製造工場 Factory

DONGGUAN BETTER ELECTRONICS

TECHNOLOGY CO.,LTD

NANMEN VILLAGE, HENKENG

ADMINISTRATIVE ZONE LIAOBU TOWN,

DONGGUAN, GUANGDONG, P.R.CHINA 523413



検査の方法 Standard for Certificate

・電気用品の技術基準の解釈 別表第十二 国際規格等に準拠した基準  
J60127-1(H26);J60127-2(H26)

・施行規則別表第四

Appendix 4 of the Enforcement Regulations

特定電気用品名 :

Name of Specified Electrical  
Appliance and Material

型式の区分 :

Type Classification

モデル名 :

Model

製造事業者 :

Manufacturer

証明書の有効期間 :

Validity of Certificate

管形ヒューズ

Cartridge fuse

(「添付書類」参照)

(Refer to Attachment)

522 T12.5AL 250V

DONGGUAN BETTER ELECTRONICS TECHNOLOGY CO.,LTD

2022年7月20日までに有効です。

This certificate is expired on Jul. 20th, 2022

これは、上記申請者より申請のあった上記特定電気用品及び製造工場が、電気用品安全法第八条第一項に規定する技術基準及び同法第九条第二項の経済産業省令で定める基準に適合していることを証明するものです。

This is to certify that the above-mentioned Specified Electrical Appliances and Materials and the factory which the above-mentioned applicant applied for have been complied with the Technical Requirements stipulated by Article 8, Paragraph 1 of the Electrical Appliance and Material Safety Law and the requirements stipulated by the METI Ordinance specified in Article 9, paragraph 2 of the said law.

中国品質認証センター  
CHINA QUALITY  
CERTIFICATION CENTRE

氏名  
Name

発行者  
Issued by



中国100070北京市南四环西路188号9区

Section 9, No.188, Nansihuan Xilu, Beijing 100070, China

PJ 0004119



# 適合証明書

Certificate of Conformity

添付書類 Attachment 1

証明書番号(Certificate No.):  
PSE15020906

発行日 Date of Issue :  
2015年7月21日

## 【 型式の区分 Type Classification 】

特定電気用品 :  
(Name of Specified Electrical Appliance and Material)

管形ヒューズ  
Cartridge fuse

要素	区分
定格電圧	(1) 125V以下のもの (2) 125Vを超えるもの
定格電流 (定格電流表示のあるものの場合に限る。)	(1) 5A以下のもの (2) 5Aを超え15A以下のもの (3) 15Aを超え30A以下のもの (4) 30Aを超え60A以下のもの (5) 60Aを超え100A以下のもの (6) 100Aを超えるもの
適用電動機の定格容量 (定格電流表示のないものの場合に限る。)	(1) 単相で200W以下のもの (2) 単相で200Wを超え400W以下のもの (3) 単相で400Wを超え750W以下のもの (4) 単相で750Wを超えるもの (5) 3相で750W以下のもの (6) 3相で750Wを超え2.2kW以下のもの (7) 3相で2.2kWを超え3.7kW以下のもの (8) 3相で3.7kWを超え7.5kW以下のもの (9) 3相で7.5kWを超えるもの
可溶体の主材料	(1) 銀のもの (2) アルミニウムのもの (3) 亜鉛のもの (4) 鉛のもの (5) 銅のもの (6) その他のもの

中国品質認証センター  
CHINA QUALITY  
CERTIFICATION CENTRE

氏名  
Name

発行者  
Issued by



中国100070北京市南四环西路188号9区

Section 9, No.188, Nansihuan Xilu, Beijing 100070, China



# 適合証明書

Certificate of Conformity

添付書類 Attachment 2

証明書番号(Certificate No.):  
PSE15020906

発行日 Date of Issue :  
2015年7月21日

## 【 型式の区分 Type Classification 】

特定電気用品 :  
(Name of Specified Electrical Appliance and Material)

管形ヒューズ  
Cartridge fuse

可溶体の数	(1) 1のもの (2) 2以上のもの
再使用 (管形ヒューズを除く。)	(1) できるもの (2) できないもの
内部充てん物	(1) あるもの (2) ないもの
筒 (内筒を除く。) の材料	(1) フェノール樹脂のもの (2) ファイバーのもの (3) 磁器のもの又はガラスのもの (4) ポリエステル樹脂のもの (5) メラミン樹脂のもの (6) ユリア樹脂のもの (7) その他のもの
端子	(1) 刃形のもの (2) 筒形のもの (3) 締付け形のもの (4) リード線付きのもの (5) その他のもの
排気孔	(1) あるもの (2) ないもの
溶断の表示	(1) あるもの (2) ないもの
用途	(1) 電動機用のもの (2) 電子機器用のもの (3) 短絡保護専用のもの (4) その他のもの

中国品質認証センター  
CHINA QUALITY  
CERTIFICATION CENTRE

氏名  
Name

発行者  
Issued by



中国100070北京市南四环西路188号9区

Section 9, No.188, Nansihuan Xilu, Beijing 100070, China



# 適合証明書

Certificate of Conformity

添付書類 Attachment 3

証明書番号(Certificate No.):  
PSE15020906

発行日 Date of Issue :  
2015年7月21日

## 【 型式の区分 Type Classification 】

特定電気用品 :  
(Name of Specified Electrical Appliance and Material)

管形ヒューズ  
Cartridge fuse

定格遮断電流	(1)	100A以下のもの
	(2)	100Aを超え300A以下のもの
	(3)	300Aを超え500A以下のもの
	(4)	500Aを超え1,000A以下のもの
	(5)	1,000Aを超え1,500A以下のもの
	(6)	1,500Aを超え2,500A以下のもの
	(7)	2,500Aを超え5,000A以下のもの
	(8)	5,000Aを超え7,500A以下のもの
	(9)	7,500Aを超え10,000A以下のもの
	(10)	10,000Aを超え15,000A以下のもの
	(11)	15,000Aを超え20,000A以下のもの
	(12)	20,000Aを超え25,000A以下のもの
	(13)	25,000Aを超え30,000A以下のもの
	(14)	30,000Aを超えるもの

中国品質認証センター  
CHINA QUALITY  
CERTIFICATION CENTRE

氏名  
Name

発行者  
Issued by



中国100070北京市南四环西路188号9区

Section 9, No.188, Nansihuan Xilu, Beijing 100070, China



# 中国国家强制性产品认证证书

证书编号：2004010207122270

## 委托人名称、地址

东莞市贝特电子科技股份有限公司  
东莞市松山湖高新技术产业开发区新竹路4号新竹苑16座办公601

## 生产者（制造商）名称、地址

东莞市贝特电子科技股份有限公司  
东莞市松山湖高新技术产业开发区新竹路4号新竹苑16座办公601

## 生产企业名称、地址

东莞市贝特电子科技股份有限公司  
东莞市寮步镇横坑南门村第二工业区C座、B座

## 产品名称和系列、规格、型号

管状熔断体

522 T250mAL250V, 522 T315mAL250V, 522 T500mAL250V, 522 T1AL250V, 522  
T1.6AL250V, 522 T2AL250V, 522 T2.5AL250V, 522 T3.15AL250V, 522 T4AL250V, 522  
T5AL250V, 522 T6.3AL250V

## 产品标准和技术要求

GB/T9364. 1-2015; GB/T9364. 2-2018

上述产品符合强制性产品认证实施规则 CNCA-C02-01:2014 的要求，  
特发此证。

发证日期：2019年12月30日 有效期至：2022年12月21日

证书有效期内本证书的有效性依据发证机构的定期监督获得保持。

本证书为变更证书，证书首次颁发日期：2004年07月15日

本证书的相关信息可通过国家认监委网站 [www.cnca.gov.cn](http://www.cnca.gov.cn) 查询

经中国合格评定国家认可委员会认可 CNAS C001-P



主任：陆梅



## 中国质量认证中心



# CERTIFICATE FOR CHINA COMPULSORY PRODUCT CERTIFICATION

**CERTIFICATE NO.: 2004010207122270**

## **NAME AND ADDRESS OF THE APPLICANT**

Dongguan Better Electronics Technology Co., Ltd.  
Room 601 of 16 Block, Xinzhu Yuan, No 4, Xinzhu Road, Songshanlake Hightech Industrial  
Development Zone, Dongguan City, Guangdong Province, PRC

## **NAME AND ADDRESS OF THE MANUFACTURER**

Dongguan Better Electronics Technology Co., Ltd.  
Room 601 of 16 Block, Xinzhu Yuan, No 4, Xinzhu Road, Songshanlake Hightech Industrial  
Development Zone, Dongguan City, Guangdong Province, PRC

## **NAME AND ADDRESS OF THE FACTORY**

Dongguan Better Electronics Technology Co., Ltd.  
NanMen Village, HengKeng Administrative Zone LiaoBu Town, Dongguan, Guangdong, China.

## **PRODUCT NAME, MODEL AND SPECIFICATION**

Cartidge Fuse-link

522 T250mAL250V,522 T315mAL250V,522 T500mAL250V,522 T1AL250V,522 T1.6AL250  
V,522 T2AL250V,522 T2.5AL250V,522 T3.15AL250V,522 T4AL250V,522 T5AL250V,522 T  
6.3AL250V

## **THE STANDARDS AND TECHNICAL REQUIREMENTS FOR THE PRODUCTS**

GB/T9364.1-2015;GB/T9364.2-2018

**This is to certify that the above mentioned product(s) complies with the requirements of  
implementation rules for compulsory certification(REFNO.CNCA-C02-01:2014).**

**Valid from:** Dec.30,2019

**Valid until:** Dec.21,2022

**The validity of the certificate is subject to positive result of the regular follow up  
inspection by issuing certification body until the expiry date.**

Date of original issued: Jul.15,2004

The certificate information is available through CNCA's website: [www.cnca.gov.cn](http://www.cnca.gov.cn)  
Accredited by China National Accreditation Service for Conformity Assessment CNAS C001-P



**President:**

Lu Mei



**CHINA QUALITY CERTIFICATION CENTRE**

접수번호 : 14-064422-01  
(Receipt No.)



# 전기용품안전인증서

## Electrical Appliances Safety Certificate

안전인증번호 : SU05042-14007  
(Certificate No.)

제조사명 : Dongguan Better Electronics Technoloy Co.,Ltd  
(Manufacturer)

대표자명 : Han Lu  
(President)

제조공장의 주소 : 2nd Industrial Zone, Nanmen Village, Hengkeng, Liao Bu Town,  
(Factory Address) Dongguan, Guangdong, P.R.China

제품명 : 퓨즈  
(Product) (Cartridge Fuse-links)

기본모델명 : 522 T6.3AL250V  
(Basic Model)

정격 : 250 VAC 6.3 A  
(Rating)

파생모델명 : 522 T5AL250V, 522 T3.15AL250V  
(Series Model)

적용기준 : KC60127-2(2014-09), K60127-1(2011-12)  
(Standard)

「전기용품안전 관리법 시행규칙」 제6조제2항에 따라 위의 전기용품에 대하여 안전인증  
서를 발급합니다.

We Issue Electrical Appliances Safety Certification as above product by Article 6 Sectio  
n 2 of the Electrical Appliances Safety Control Law Enforcement Regulation.

2015 년 02 월 17 일  
Year month day



한국산업기술시험원장  
KOREA TESTING LABORATORY



\* 이 인증서는 「전기용품안전 관리법」에 따른 전기용품 안전성 확인에 한정된 것이며, 그 밖의 다른  
법률이 적용되는 제품의 경우에는 해당 법률에 따라 추가로 인증·허가 등을 받아야 합니다.

- 첨부 :  
(Annex)
1. 안전관리부품 및 재질목록 (List of Critical Components)
  2. 기본모델·파생모델의 내용 (Descriptions of the basic and series model)
  3. 전기용품안전인증의 변경 현황 (Revisions Status)



**첨부 1 : 안전관리부품 및 재질목록**  
 List of Critical Components

부품명(회로기호) Component(Part no.)	제조사(상표명) Manufacturer(Brand)	모델명(형식) Model(Type)	정격 또는 특성 Rating or Characteristics	인증마크 Tested by
Not applicable				
<p><input type="checkbox"/> <b>유의사항 (Attention) :</b></p> <p>1. 안전관리부품은 전기적인 안전에 직접적인 영향을 주는 부품으로서 안전인증기관이 정기공장검사 시 확인 관리 하는 사항입니다. 따라서 상기목록에 기재된 사항을 변경하거나 또는 복수등재를 원하시는 경우는 안전인증기관에 인증변경신청을 하여야 합니다.</p> <p><i>As the "Critical components" are parts in directly related with safety, these components shall be checked during a factory inspection by the certification body. In case of applying multiful listing or changing the items above, the certification revision shall be applied.</i></p> <p>2. 인증변경신청 없이 임의로 변경하는 경우는, 전기용품안전관리법 제 8 조제 1 항의 규정에 의한 안전인증취소 사유가 됨을 유의하시기 바랍니다.</p> <p><i>The Safety Certification will be cancelled under the Safety Control Law for Electrical Appliances, Paragraph 1 of Article 8 if the contents of the Certification is altered without our authorization.</i></p>				

FP511-10-00

**첨부 2 : 기본모델 · 파생모델의 내용**  
 General description of Certified Products

파생모델명 Derivative model	기본모델과의 차이점 Differences between the basic and derivative model(s)
522 T5AL250V	Rated current (5A) is different.
522 T3.15AL250V	Rated current (3.15A) is different.
제품특기사항 및 시험조건 Remarks & Test conditions	
<p>1. Test report number: 14-064422-01</p> <p>2. Product Description</p> <ul style="list-style-type: none"> <li>- AC 250 V 6.3 A</li> <li>- Rated Breaking capacity : 63 A</li> <li>- Time-lag type, low-breaking capacity</li> <li>- Standard sheet 3</li> </ul>	
<p><input type="checkbox"/> 본 제품의 시험내용에 관하여 문의하실 사항이 있으시면 아래 연락처로 문의하시기 바랍니다.        시험담당자: 디지털산업본부 전기용품평가센터 박갑수 / (02)860-1427</p> <p><input type="checkbox"/> <i>If you have any question on product testing, please contact the person below:</i>  <i>Job holder: G.S Park /+82 2 860-1427</i></p>	

FP511-09-00

**첨부 3 : 전기용품안전인증의 변경 현황**  
 Status of Certificate Revisions

변경발급 내용 Contents of Certificate Revisions
Not applicable

FP511-11-00

## X-ON Electronics

Largest Supplier of Electrical and Electronic Components

*Click to view similar products for [Surface Mount Fuses](#) category:*

*Click to view products by [Better manufacturer](#):*

Other Similar products are found below :

[FHC20402ADTP](#) [NFVC6125S0R50TRF](#) [SFT-125MA](#) [TF16SN2.00TTD](#) [7010.9810.57](#) [FCC16501ABTP](#) [FCC16102ABTP](#) [FHC16322ADTP](#)  
[0308.250UR](#) [0308.375UR](#) [0308.500UR](#) [0308.750UR](#) [0308001.UR](#) [030801.5UR](#) [FCC16202ABTP](#) [F0603G0R03FNTR](#) [SKY87604-12](#)  
[SKY87604-11](#) [SKY87604-13](#) [3404.0110.22](#) [7010.9962.63](#) [R451003.L](#) [R451.500L](#) [R451001.L](#) [3-103-119](#) [3-103-123](#) [S1206-FC-1.0A](#)  
[CFS06V3TR63](#) [F06F3](#) [F12F7](#) [F12T20](#) [F06T0.5](#) [F12F2.5](#) [F06F1](#) [F06F8](#) [F06T1](#) [F12F10](#) [F06F2](#) [F06F0.75](#) [F06F6](#) [F06F1.5](#) [F12T5](#)  
[F12T1.25](#) [F06F0.5](#) [06 100.2](#) [F06T3](#) [F12T12](#) [TA3VT4](#) [24T 5A250V](#) [F12F1.5](#)