



贝特卫士®

更好的电路安全卫士!
You build electronics, We safeguard them!

承 认 书

APPROVAL SHEET

| | |
|---------|------------------|
| 编号 No. | BTT010142B-D/5-B |
| 日期 Date | 2020.06.15 |

| | |
|-----------------|--|
| 客 户 Customer | |
|-----------------|--|

| | |
|----------------|---------------|
| 品 名 Product | Thermal Links |
| 系 列 Series | BTT Series |

| 料号 Part No. | 规格描述 Specification | 备注 Remark |
|--------------------|--------------------|-----------|
| 贝特电子 Betterfuse | | |
| 客 户 Customer | | |

| |
|--|
| 环保特别提示 Special instructions for environmental protection |
| 本产品: |

| 供应商-贝特电子 Supplier-Betterfuse | 零件承认章 Approval Signet | 客 户 Customer | 零件承认章 Approval Signet |
|---------------------------------|--------------------------|-----------------|--------------------------|
| 制 作 Make | YaLan Wang | | |
| 审 核 Check | YaBao Zhong | | |
| 确 认 Approval | Zhimin Hu | | |

| | | | |
|--|--------------|--------------|-----------|
| 联络 Contact | | | |
| 业务 Sales | 电话 Telephone | 手机 Cellphone | 邮箱 E-mail |
| | | | |
| 零件承认后敬请回签一份给我司留存, 或将承认后的封面传真(0769-8352 1857)至我司, 谢谢! | | | |



| Document Record | | | | | | |
|-----------------|------------|---|------------|---------|----------------------|--------------|
| No. | Date | Modified Content | Page | Edition | Prepared/modified by | Checked by |
| 1 | 2013.02.14 | Draft | 6 | A | Runsong Zhong | Lianghua Guo |
| 2 | 2015.12.25 | Update UL certification | 9,12~14,17 | B/5 | Jeffery | Lin Gao |
| 3 | 2016.02.23 | Add the 216°C VDE certification | 12 | B/6 | Jeffery | Lin Gao |
| 4 | 2016.03.30 | Add the Tf: 73, 84, 128, 157, 184, 216°C UL certification | 12 | B/7 | Jeffery | Helge |
| 5 | 2016.5.13 | Update the CCC certification | 3,6 | B/8 | Jeffery | Helge |
| 6 | 2016.8.23 | Change the Tf 172, 240°C operating temperature, remove the Ip | | B/9 | Jeffery | Hu Zhimin |
| 7 | 2016.11.08 | Change the operation temperature 71°C to 69°C | | B/10 | Jeffery | Hu Zhimin |
| 8 | 2017.11.23 | Update the CCC certification | | C/0 | J.Q. | Zhimin Hu |
| 9 | 2018.07.03 | Update UL certification | | C/1 | J.Q. | Zhimin Hu |
| 10 | 2018.10.16 | Update UL certification | 10 | C/2 | Xiang Xiong | Zhimin Hu |
| 11 | 2019.01.22 | Update 077 Operating temperature | 6 | C/3 | Xiang Xiong | Zhimin Hu |
| 12 | 2019.03.22 | Update VDE certification | 4 | C/4 | Xiang Xiong | Zhimin Hu |
| 13 | 2019.07.01 | Update product size drawing | 5 | C/5 | Xiang Xiong | Zhimin Hu |
| 14 | 2019.09.04 | Add 249 operation | 6 | D/0 | YaLan Wang | Zhimin Hu |
| 15 | 2019.12.30 | Add the Tf 229°C CCC certification | 6 | D/1 | YaLan Wang | Zhimin Hu |
| 16 | 2020.02.26 | Add the Tf 184°C PSE certification | 6 | D/2 | YaLan Wang | Zhimin Hu |
| 17 | 2020.03.13 | Add the Tf 229°C PSE certification | 6 | D/3 | YaLan Wang | Zhimin Hu |
| 18 | 2020.03.26 | Add the Tf 229°C cURus certification | 6 | D/4 | YaLan Wang | Zhimin Hu |
| 19 | 2020.06.15 | Add the Tf 229°C TUV certification | 6 | D/5 | YaLan Wang | Zhimin Hu |



TABLE OF CONTENTS

| | |
|---|----|
| 1. SCOPE AND DESCRIPTION..... | 4 |
| 2. GENERAL INFORMATION..... | 4 |
| 3. AGENCY APPROVALS..... | 4 |
| 4. PART NUMBERING SYSTEM..... | 5 |
| 5. CONSTRUCTION AND MECHANICAL CHARACTERISTICS..... | 5 |
| 6. OPERATION PRINCIPLE..... | 6 |
| 7. ELECTRICAL SPECIFICATIONS..... | 7 |
| 8. INSTALLATION AND SOLDERING..... | 8 |
| 9. ORDERING INFORMATION..... | 9 |
| 10. PACKING INFORMATION..... | 10 |



1. SCOPE AND DESCRIPTION



The following product specifications apply to fuses of the BTT series. The BTT series consists of thermal cutoff fuses for over-temperature protection. The BTT series thermal fuses are widely used in various applications such as transformers, adapters, secondary batteries, household appliances, gas water heaters, lighting and other heating equipment.

2. GENERAL INFORMATION

General Description

The BTT thermal cutoff fuses are non-resetting single-pole and normally closed devices and provide accurate, reliable protection for high temperature applications against overheating through interrupting electric current. With their metal body and strong leads these fuses offer a sturdy built and high rated currents such as 10 or 15 Amperes.

Detailed Features

- Metal casing, epoxy sealing material
- Small size, $\Phi 4.0\text{mm} \times 10\text{mm}$
- 1.0mm lead wires made of tin or silver plated copper.
- Protection against harmful over-temperature in primary and secondary applications.
- Lead-free, RoHS compliant
- Designed according to IEC 60691, UL 60691, EN 60691, etc.

3. AGENCY APPROVALS

| Agency | Agency File Number | Tf Range |
|---|---|---|
| | E346843 | Tf: 73°C; 77°C; 84°C; 99°C; 113°C; 121°C; 128°C; 133°C; 142°C; 157°C; 172°C; 184°C; 192°C; 216°C; 229°C; 240°C; |
| | 2013010205660964 | Tf: 73°C; 77°C; 84°C; 94°C; 99°C; 113°C; 121°C; 128°C; 133°C; 142°C; 157°C; 172°C; 184°C; 192°C; 216°C; 240°C |
| | 2019010205257357 | Tf: 229°C |
|  | PSE13020652 PSE13020653 PSE13020654 PSE13020655 PSE13020656 PSE13020657 PSE13020658 PSE13020659 PSE13020660 PSE20021602 PSE20021603 | Tf: 240°C Tf: 216°C Tf: 192°C Tf: 172°C Tf: 142°C; 157°C Tf: 121°C; 128°C; 133°C Tf: 113°C; Tf: 84°C; 94°C; 99°C Tf: 73°C; 77°C Tf: 184°C Tf: 229°C |



| | | |
|--|---|--|
| | R 50273319 | Tf: 73°C; 77°C; 84°C; 94°C; 99°C; 113°C; 121°C; 128°C; 133°C; 142°C; 157°C; 172°C; 192°C; 216°C; 229°C; 240°C |
| | 40041299 | Tf: 73°C; 99°C; 113°C; 121°C; 133°C; 142°C; 157°C; 172°C; 184°C; 192°C; 216°C; 240°C |
| | SU05042-14004 SU05042-14005 SU05042-14006 SU05042-14002 SU05042-14003 | Tf: 113°C Tf: 157°C; 121°C; 128°C; 133°C; 142°C Tf: 192°C; 172°C Tf: 240°C; 216°C Tf: 99°C; 73°C; 77°C; 84°C; 94°C |

4. PART NUMBERING SYSTEM

4.1 Part Number

Example: BTT010142B

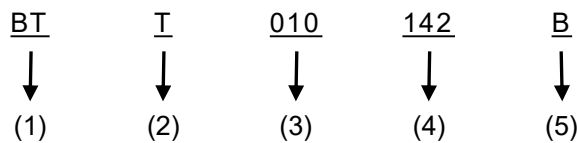

- | | | |
|-------------------------------|-----------|--------------------------------------|
| (1) Model | ...BT... | Better's Brand |
| (2) Product Type..... | ...T... | Thermal fuse |
| (3) Rated Current..... | ...010... | Rated current: 10A |
| | ...015... | Rated current: 15A |
| (4) Functional Temperature... | ...142... | Tf: 142°C |
| (5) Size | ...A... | Special series with lead length 18mm |
| | ...B... | Normal series with lead length 18mm |
| | ...C... | Special series with lead length 43mm |
| | ...D... | Normal series with lead length 43mm |

5. CONSTRUCTION AND MECHANICAL CHARACTERISTICS

Construction (cross section)

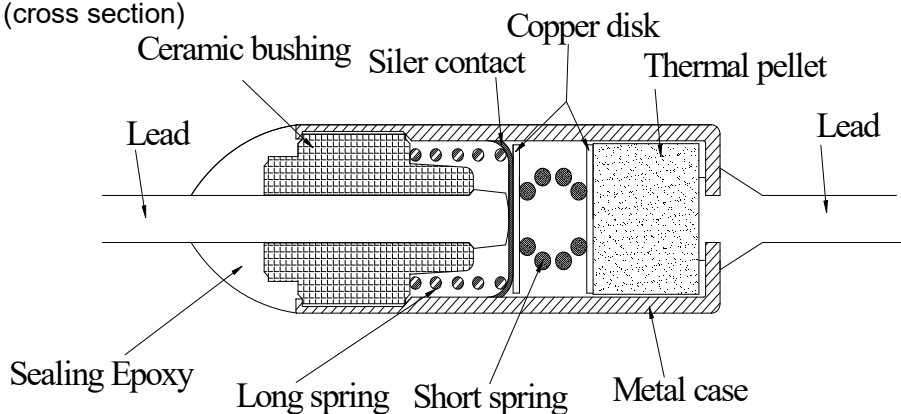



Dimensions (units: mm)

- ☆ BTTXXXXXXA: Special, length 18mm
- BTTXXXXXXB: Normal, length 18mm
- BTTXXXXXXC: Special, length 43mm
- BTTXXXXXXD: Normal, length 43mm

6. OPERATION PRINCIPLE

Before action:

In normal condition the thermal pellet keeps the Short Spring in tension, which provides contact between the copper disk and the silver contact. All parts, lead A, silver contact, metal case and lead B are connected and electric circuit current can pass freely through the thermal fuse.

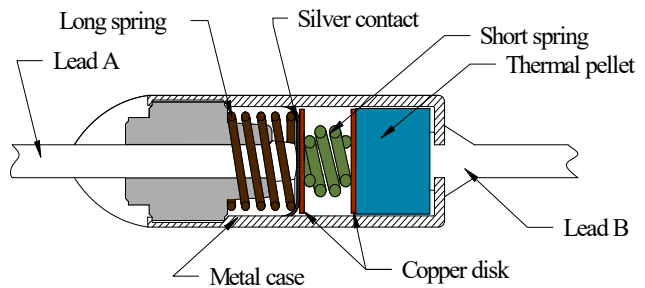

Cut off:

When the temperature increases and reaches the Rated Functioning Temperature(Tf), the thermal pellet starts to melt and liquefies. this will release the Long Spring and separates the silver contact from the lead, cutting off the current.

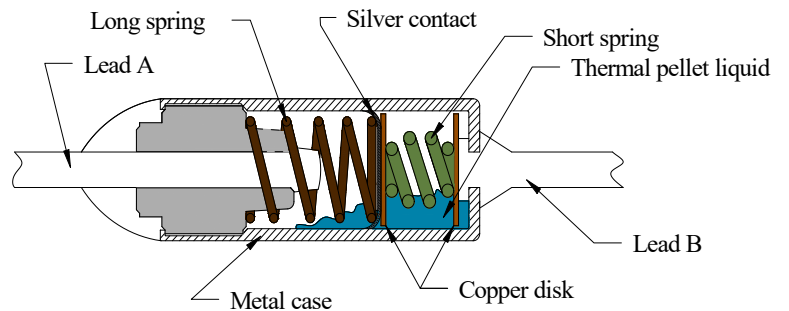



7. ELECTRICAL SPECIFICATIONS

Electrical Characteristics at 25°C

| NO. | Part number | Tf (°C) | Operating Temperature (°C) | Th (°C) | Tm (°C) | Ir (A) | | Voltage (V) | Approvals | | | | | |
|-----|-------------|---------|----------------------------|---------|---------|--------|-----|-------------|-----------|-----|-----|-----|-----|----|
| | | | | | | | | | UL | CCC | TUV | PSE | VDE | KC |
| 1 | BTT0**073 | 73 | 69±2 | 50 | 150 | 10A | 15A | 250Vac | ● | ● | ● | ● | ● | ● |
| 2 | BTT0**077 | 77 | 72±2 | 62 | 150 | 10A | 15A | 250Vac | ● | ● | ● | ● | ○ | ● |
| 3 | BTT0**084 | 84 | 80±3 | 50 | 150 | 10A | 15A | 250Vac | ● | ● | ● | ● | ○ | ● |
| 4 | BTT0**094 | 94 | 91+3-2 | 65 | 150 | 10A | 15A | 250Vac | ○ | ● | ● | ● | ○ | ● |
| 5 | BTT0**099 | 99 | 95±2 | 71 | 150 | 10A | 15A | 250Vac | ● | ● | ● | ● | ● | ● |
| 6 | BTT0**113 | 113 | 108+2-3 | 95 | 180 | 10A | 15A | 250Vac | ● | ● | ● | ● | ● | ● |
| 7 | BTT0**121 | 121 | 117±3 | 106 | 180 | 10A | 15A | 250Vac | ● | ● | ● | ● | ● | ● |
| 8 | BTT0**128 | 128 | 124±3 | 102 | 160 | 10A | 15A | 250Vac | ● | ● | ● | ● | ○ | ● |
| 9 | BTT0**133 | 133 | 129+3-2 | 105 | 160 | 10A | 15A | 250Vac | ● | ● | ● | ● | ● | ● |
| 10 | BTT0**142 | 142 | 138±3 | 110 | 160 | 10A | 15A | 250Vac | ● | ● | ● | ● | ● | ● |
| 11 | BTT0**157 | 157 | 152±2 | 130 | 175 | 10A | 15A | 250Vac | ● | ● | ● | ● | ● | ● |
| 12 | BTT0**172 | 172 | 168±3 | 145 | 190 | 10A | 15A | 250Vac | ● | ● | ● | ● | ● | ● |
| 13 | BTT0**184 | 184 | 180±2 | 160 | 210 | 10A | 15A | 250Vac | ● | ● | ○ | ● | ● | ○ |
| 14 | BTT0**192 | 192 | 189±2 | 170 | 300 | 10A | 15A | 250Vac | ● | ● | ● | ● | ● | ● |
| 15 | BTT0**216 | 216 | 213±3 | 190 | 300 | 10A | 15A | 250Vac | ● | ● | ● | ● | ● | ● |
| 16 | BTT0**229 | 229 | 225±2 | 200 | 380 | 10A | 15A | 250Vac | ● | ● | ● | ● | ○ | ○ |
| 17 | BTT0**240 | 240 | 235±2 | 200 | 300 | 10A | 15A | 250Vac | ● | ● | ● | ● | ● | ● |

Note: (1) **: Response the 10 or 15.

(2) ●=Approved ○=Pending

(3) Except CCC certification, in UL&VDE&TUV&PSE&KC certifications, for BTT0**077 by Th is 50° C; for BTT0**113 by Th is 85° C, Tm is 150° C; for BTT0**121 by Th is 95° C, Tm is 160° C.

(4) The 125VAC certification only for UL.

| Ratings | Indicator | Description |
|-------------------------------|-----------|--|
| Rated Functioning Temperature | Tf | The temperature at which the thermal cutoff fuse changes its state of conductivity and opens the circuit with detection current of <10mA as the only load. The temperature tolerance for UL CSA and VDE standards is +0. -10°C |
| Hold Temperature | Thold | The maximum temperature at which a thermal cutoff can be maintained while conducting rated current for 168 hours without causing a change in the conductivity to open the circuit. |
| Maximum Temperature Limit | Tm | At the rated voltage, the temperature the fuse can withstand for 10 minutes at highest temperature rating without change in the conductivity |
| Rated Current | Ir | The maximum current which the thermal cutoff fuse is able to carry and not affect its electrical characteristics. |
| Rated Voltage | Vr | The maximum voltage which the thermal cutoff fuse is able to carry and not affect its electrical characteristics. |



7.1 Test Conditions

7.1.1 Resistance Standard

Test Environment Temperature: 25±5°C

Test Conditions: Centering on the shell, 25 mm (diagram below)

Standard: less than 1.5mΩ

7.1.2 Insulation Resistance

Test Conditions: After fusing between wire and the wire

Test Standard: DC 500V; more than 1000 MΩ

7.1.3 Withstand Voltage

Test Conditions: After fusing between wire and the wire

Test Standard: Bear AC500V; No damage for 1 minute ontology (leakage current: 0.5 mA)

7.2 Storage Environment

Please put the temperature fuse in the packing, storage in temperature 10 °C to 40 °C, relative humidity 30-75%, the fuse individual parts have silver plating processing, when by sulfide, there will be change by color and affect the welding effect, please note that don't make the product contact sulfide gas.

7.3 Mark

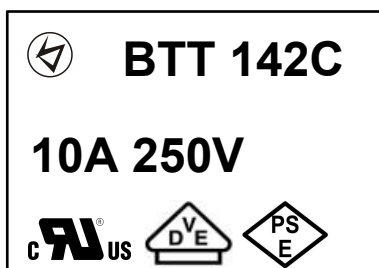

Note:

-  : Betterfuse Mark
- BTT : Series Name
- 10A : Rated Current
- 250V : Rated Voltage
- 142°C : Action Temperature

 : Safety Certification

8. INSTALLATION AND SOLDERING

1. Installation Location

- 1.1 Make sure that the thermal fuse and its leads are fully able to detect ambient heat.
- 1.2 Ensure that the thermal fuse in your design is located as

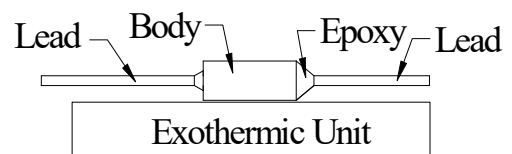



close to the source of a heat risk as possible.

2. Lead Forming

- 2.1 When bending the thermal fuses, make sure the bending point is at least 3mm away from the thermal fuses body.
- 2.2 When bending then thermal fuses, make sure that the fuse body and epoxy shows no signs of cracking or breaking.
- 2.3 During assembly and normal operation, make sure the thermal fuses is not subjected to mechanical force.

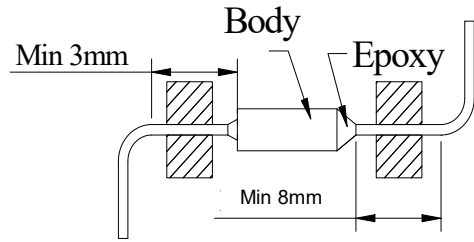

3. Soldering

- 3.1 Do not use solder on low temperature models.
- 3.2 Do soldering work on the leads as far away from the fuse body as possible.
- 3.3 Make sure to keep soldering time as short as possible. To shorten the time, employ pre-soldering process at the intended soldering area. Use a heatsink to prevent heat.
- 3.4 After soldering, check resistance to ensure that the thermal fuses has not been damaged.

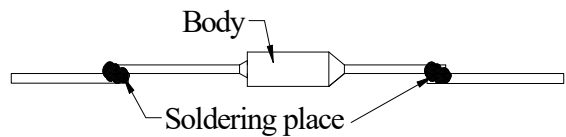

4. Connections in electronic circuit

- 4.1 Do not let the lead contacts and epoxy get connected with the fuses body. Do not connect to other conductive parts such as metal.
- 4.2 If the thermal fuses' body is made of metal, consider its effect on other components in the electronic circuit.

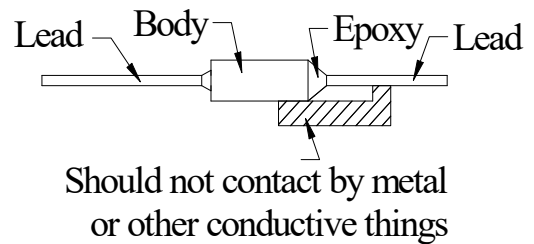

5. Handling and Storage

- 5.1 During transport and assembly, make sure that the thermal fuse is not subjected to strenuous vibrations, it is maybe cause damage to fuses.
- 5.2 Avoid any mechanical force that maybe cause damage to thermal fuses.
- 5.3 The shelf life is 12 months storage, during which the fuse must avoid sunlight and dusty environment.

9.ORDERING INFORMATION

The following information are necessary in order to place your order with us correctly:

| Series | Function Temperature (Tf) | Supplementary Code | Qty |
|--------|---------------------------|--------------------|-----|
| BTT | | | |



10.PACKING INFORMATION

Packing details

Unit:mm

Plastic bag

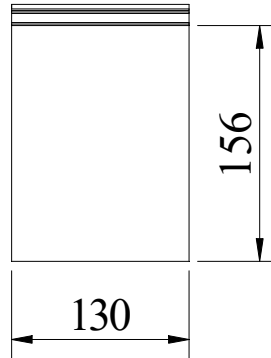

Inner Packaging Box

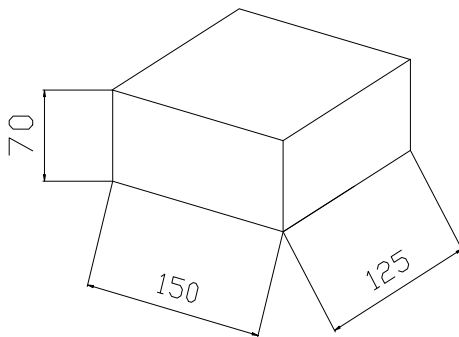

Master Carton

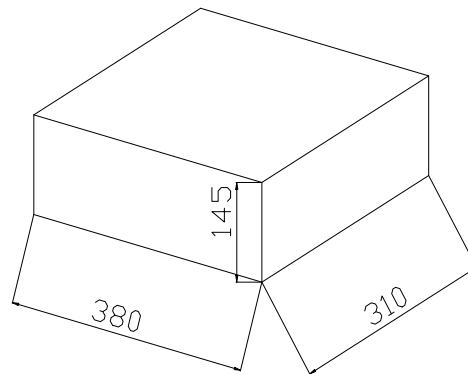

| | | | | | |
|-------------|--------|------------------|---------|----------------------|----------|
| Net Weight | 247g | Inner box weight | 1.23kg | Master Carton Weight | 14.6kg |
| Qty per bag | 250pcs | Qty per box | 1000pcs | Qty per carton | 10000pcs |

© Dongguan Better Electronics Technology Co., Ltd.

东莞市贝特电子科技股份有限公司

Room 601 of 16 Block, Xinzhu Yuan, No.4, Xinzhu Road, Songshanlake Hightech Industrial Development Zone, Dongguan City, Guangdong P.R.C

中国广东省东莞市松山湖国家高新技术产业开发区新竹路4号新竹苑16座办公601

Tel: +86 769-2307 8212 Fax: +86 769-8352 1857

Web: www.betterfuse.com

Email: info@betterfuse.com

XCMQ2.E346843 - Thermal Links - Component

Thermal Links - Component

See General Information for Thermal Links - Component

DONGGUAN BETTER ELECTRONICS TECHNOLOGY CO LTD

E346843

Rm 601 Of 16 Blk

Xinzhu Yuan No 4 Xinzhu Rd

Songshanlake Hightech Industrial Development Zone

Dongguan, Guangdong 523808 CHINA

Thermal links, Model(s) BTT010073, BTT010077, BTT010084, BTT010099, BTT010113, BTT010121, BTT010128, BTT010133, BTT010142, BTT010157, BTT010172, BTT010184, BTT010192, BTT010216, BTT015073, BTT015077, BTT015084, BTT015099, BTT015113, BTT015121, BTT015128, BTT015133, BTT015142, BTT015157, BTT015172, BTT015184, BTT015192, BTT015216

Model(s) BTA135C1A, BTA145C1A, BTA150C1A, BTB115C2A, BTA115C1A, BTB125C2A, BTA125C1A, BTB130C2A, BTA130C1A, BTB135C2A, BTB145C2A, BTB150C2A, BTC115C 3.5A, BTC115C 3A, BTT010229, BTT015229, BTT015240, BTT010240, BTT113C 15A, BTT113C 10A, BTT121C 15A, BTT121C 10A, BTT128C 15A, BTT128C 10A, BTT133C 15A, BTT133C 10A, BTT142C 15A, BTT142C 10A, BTT157C 15A, BTT157C 10A, BTT172C 15A, BTT172C 10A, BTT184C 15A, BTT184C 10A, BTT192C 15A, BTT192C 10A, BTT216C 15A, BTT216C 10A, BTT229C 10A, BTT229C 15A, BTT240C 15A, BTT240C 10A, BTT73C 15A, BTT73C 10A, BTT77C 15A, BTT77C 10A, BTT84C 15A, BTT84C 10A, BTT99C 15A, BTT99C 10A, BTW150C 1A, BTW150C 2A

Marking: Company name or trademark  and model designation.

Last Updated on 2020-03-25

The appearance of a company's name or product in this database does not in itself assure that products so identified have been manufactured under UL's Follow-Up Service. Only those products bearing the UL Mark should be considered to be Certified and covered under UL's Follow-Up Service. Always look for the Mark on the product.

UL permits the reproduction of the material contained in the Online Certification Directory subject to the following conditions: 1. The Guide Information, Assemblies, Constructions, Designs, Systems, and/or Certifications (files) must be presented in their entirety and in a non-misleading manner, without any manipulation of the data (or drawings). 2. The statement "Reprinted from the Online Certifications Directory with permission from UL" must appear adjacent to the extracted material. In addition, the reprinted material must include a copyright notice in the following format: "© 2020 UL LLC"

XCMQ8.E346843 - Thermal Links Certified for Canada - Component

Thermal Links Certified for Canada - Component

See General Information for Thermal Links Certified for Canada - Component

DONGGUAN BETTER ELECTRONICS TECHNOLOGY CO LTD

E346843

Rm 601 Of 16 Blk

Xinzhu Yuan No 4 Xinzhu Rd

Songshanlake Hightech Industrial Development Zone

Dongguan, Guangdong 523808 CHINA

Thermal links, Model(s) BTT010073, BTT010077, BTT010084, BTT010099, BTT010113, BTT010121, BTT010128, BTT010133, BTT010142, BTT010157, BTT010172, BTT010184, BTT010192, BTT010216, BTT015073, BTT015077, BTT015084, BTT015099, BTT015113, BTT015121, BTT015128, BTT015133, BTT015142, BTT015157, BTT015172, BTT015184, BTT015192, BTT015216

Model(s) BTA135C1A, BTA145C1A, BTA150C1A, BTB115C2A, BTA115C1A, BTB125C2A, BTA125C1A, BTB130C2A, BTA130C1A, BTB135C2A, BTB145C2A, BTB150C2A, BTC115C 3.5A, BTC115C 3A, BTT010229, BTT015229, BTT015240, BTT010240, BTT113C 15A, BTT113C 10A, BTT121C 15A, BTT121C 10A, BTT128C 15A, BTT128C 10A, BTT133C 15A, BTT133C 10A, BTT142C 15A, BTT142C 10A, BTT157C 15A, BTT157C 10A, BTT172C 15A, BTT172C 10A, BTT184C 15A, BTT184C 10A, BTT192C 15A, BTT192C 10A, BTT216C 15A, BTT216C 10A, BTT229C 10A, BTT229C 15A, BTT240C 15A, BTT240C 10A, BTT73C 15A, BTT73C 10A, BTT77C 15A, BTT77C 10A, BTT84C 15A, BTT84C 10A, BTT99C 15A, BTT99C 10A, BTW150C 1A, BTW150C 2A

Marking: Company name or trademark  , model designation and the Recognized Component Mark for Canada, 

Last Updated on 2020-03-25

The appearance of a company's name or product in this database does not in itself assure that products so identified have been manufactured under UL's Follow-Up Service. Only those products bearing the UL Mark should be considered to be Certified and covered under UL's Follow-Up Service. Always look for the Mark on the product.

UL permits the reproduction of the material contained in the Online Certification Directory subject to the following conditions: 1. The Guide Information, Assemblies, Constructions, Designs, Systems, and/or Certifications (files) must be presented in their entirety and in a non-misleading manner, without any manipulation of the data (or drawings). 2. The statement "Reprinted from the Online Certifications Directory with permission from UL" must appear adjacent to the extracted material. In addition, the reprinted material must include a copyright notice in the following format: "© 2020 UL LLC"



中国国家强制性产品认证证书

证书编号：2013010205660964

委托人名称、地址

东莞市贝特电子科技股份有限公司
东莞市松山湖高新技术产业开发区新竹路4号新竹苑16座办公601

生产者（制造商）名称、地址

东莞市贝特电子科技股份有限公司
东莞市松山湖高新技术产业开发区新竹路4号新竹苑16座办公601

生产企业名称、地址

东莞市贝特电子科技股份有限公司
东莞市寮步镇横坑南门村第二工业区C座、B座

产品名称和系列、规格、型号

热熔断体

BTT Tf:73℃, Th:50℃, Tm:150℃; Tf:77℃, Th:62℃, Tm:150℃; Tf:84℃, Th:50℃, Tm:150℃; Tf:94℃, Th:65℃, Tm:150℃; Tf:99℃, Th:71℃, Tm:150℃; Tf:113℃, Th:95℃, Tm:180℃; Tf:121℃, Th:106℃, Tm:180℃; Tf:128℃, Th:102℃, Tm:160℃; Tf:133℃, Th:105℃, Tm:160℃; Tf:142℃, Th:110℃, Tm:160℃; Tf:157℃, Th:130℃, Tm:175℃; Tf:172℃, Th:145℃, Tm:190℃; Tf:184℃, Th:160℃, Tm:210℃; Tf:192℃, Th:165℃, Tm:300℃; Tf:216℃, Th:190℃, Tm:300℃; Tf:240℃, Th:190℃, Tm:300℃ 250V AC 10A/ 250V AC 15A 电阻性负载 PTI 250

产品标准和技术要求

GB/T9816.1-2013

上述产品符合强制性产品认证实施规则 CNCA-C02-01:2014 的要求，特发此证。

发证日期：2017年10月30日 有效期至：2022年10月30日

证书有效期内本证书的有效性依据发证机构的定期监督获得保持。

本证书为变更证书，证书首次颁发日期：2013年12月24日

本证书的相关信息可通过国家认监委网站 www.cnca.gov.cn 查询



主任：



中国质量认证中心



CERTIFICATE FOR CHINA COMPULSORY PRODUCT CERTIFICATION

CERTIFICATE NO.: 2013010205660964

NAME AND ADDRESS OF THE APPLICANT

Dongguan Better Electronics Technology Co., Ltd.
Room 601 of 16 Block, Xinzhu Yuan, No 4, Xinzhu Road, Songshanlake Hightech Industrial Development Zone, Dongguan City, Guangdong Province, PRC

NAME AND ADDRESS OF THE MANUFACTURER

Dongguan Better Electronics Technology Co., Ltd.
Room 601 of 16 Block, Xinzhu Yuan, No 4, Xinzhu Road, Songshanlake Hightech Industrial Development Zone, Dongguan City, Guangdong Province, PRC

NAME AND ADDRESS OF THE FACTORY

Dongguan Better Electronics Technology Co., Ltd.
NanMen Village, HengKeng Administrative Zone LiaoBu Town, Dongguan, Guangdong, China.

PRODUCT NAME, MODEL AND SPECIFICATION

Thermal Links

BTT Tf:73°C, Th:50°C, Tm:150°C; Tf:77°C, Th:62°C, Tm:150°C; Tf:84°C, Th:50°C, Tm:150°C; Tf:94°C, Th:65°C, Tm:150°C; Tf:99°C, Th:71°C, Tm:150°C; Tf:113°C, Th:95°C, Tm:180°C; Tf:121°C, Th:106°C, Tm:180°C; Tf:128°C, Th:102°C, Tm:160°C; Tf:133°C, Th:105°C, Tm:160°C; Tf:142°C, Th:110°C, Tm:160°C; Tf:157°C, Th:130°C, Tm:175°C; Tf:172°C, Th:145°C, Tm:190°C; Tf:184°C, Th:160°C, Tm:210°C; Tf:192°C, Th:165°C, Tm:300°C; Tf:216°C, Th:190°C, Tm:300°C; Tf:240°C, Th:190°C, Tm:300°C 250V AC 10A/ 250V AC 15A 电阻性负载 PTI 250

THE STANDARDS AND TECHNICAL REQUIREMENTS FOR THE PRODUCTS

GB/T9816.1-2013

This is to certify that the above mentioned product(s) complies with the requirements of implementation rules for compulsory certification(REFNO.CNCA-C02-01:2014).

Valid from: Oct.30,2017

Valid until: Oct.30,2022

The validity of the certificate is subject to positive result of the regular follow up inspection by issuing certification body until the expiry date.

Date of original issued: Dec.24,2013

The certificate information is available through CNCA's website: www.cnca.gov.cn



President:

Wang Kejiao



CHINA QUALITY CERTIFICATION CENTRE

<http://www.cqc.com.cn>

Section 9, No. 188, Nansihuan Xilu, Beijing 100070 P. R. China

Tel: +86 10 83886666

Q 1813452



中国国家强制性产品认证证书

证书编号：2019010205257357

委托人名称、地址

东莞市贝特电子科技股份有限公司
东莞市松山湖高新技术产业开发区新竹路4号新竹苑16座办公601

生产者（制造商）名称、地址

东莞市贝特电子科技股份有限公司
东莞市松山湖高新技术产业开发区新竹路4号新竹苑16座办公601

生产企业名称、地址

东莞市贝特电子科技股份有限公司
东莞市寮步镇横坑三和路7号

产品名称和系列、规格、型号

热熔断体

BTT Tf:229℃, Th:200℃, Tm:380℃; 250V AC 10A/ 250V AC 15A 电阻性负载 PTI 250

产品标准和技术要求

GB/T9816.1-2013

上述产品符合强制性产品认证实施规则 CNCA-C02-01:2014 的要求，
特发此证。

发证日期：2019年12月23日 有效期至：2024年12月23日

证书有效期内本证书的有效性依据发证机构的定期监督获得保持。

本证书的相关信息可通过国家认监委网站 www.cnca.gov.cn 查询
经中国合格评定国家认可委员会认可 CNAS C001-P



主任：

陆梅



中国质量认证中心



CERTIFICATE FOR CHINA COMPULSORY PRODUCT CERTIFICATION

CERTIFICATE NO.: 2019010205257357

NAME AND ADDRESS OF THE APPLICANT

Dongguan Better Electronics Technology Co., Ltd.
Room 601 of 16 Block, Xinzhu Yuan, No 4, Xinzhu Road, Songshanlake Hightech Industrial
Development Zone, Dongguan City

NAME AND ADDRESS OF THE MANUFACTURER

Dongguan Better Electronics Technology Co., Ltd.
Room 601 of 16 Block, Xinzhu Yuan, No 4, Xinzhu Road, Songshanlake Hightech Industrial
Development Zone, Dongguan City

NAME AND ADDRESS OF THE FACTORY

Dongguan Better Electronics Technology Co.,Ltd.
No.7, Sanhe Road, Hengkeng Administrative Zone, Liaobu Town, Dongguan City, Guangdong
Province, P.R.C

PRODUCT NAME, MODEL AND SPECIFICATION

Thermal Links
BTT Tf:229°C, Th:200°C, Tm:380°C; 250V AC 10A/ 250V AC 15A 电阻性负载 PTI
250

THE STANDARDS AND TECHNICAL REQUIREMENTS FOR THE PRODUCTS

GB/T9816.1-2013

This is to certify that the above mentioned product(s) complies with the requirements of implementation rules for compulsory certification(REFNO.CNCA-C02-01:2014).

Valid from: Dec.23,2019

Valid until: Dec.23,2024

The validity of the certificate is subject to positive result of the regular follow up inspection by issuing certification body until the expiry date.

The certificate information is available through CNCA's website: www.cnca.gov.cn
Accredited by China National Accreditation Service for Conformity Assessment CNAS C001-P

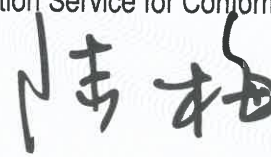

President: 
Lu Mei



CHINA QUALITY CERTIFICATION CENTRE

Zertifikat

Certificate



Zertifikat Nr. *Certificate No.*
R 50273319

Blatt *Page*
0001

Ihr Zeichen *Client Reference*

Unser Zeichen *Our Reference*

Ausstellungsdatum

Date of Issue
(day/mo/yr)

05-HUANGHA- 16056809 001 08.01.2014

Genehmigungsinhaber *License Holder*

Dongguan Better Electronics
Technology Co., Ltd.
Room No. 102, 103 of 3rd block
114 of 4th Block Innovtive Tech.
Park of Songshan Lake High-tech Ind.
Park, Dongguan, Guangdong
P.R. China

Fertigungsstätte *Manufacturing Plant*

Dongguan Better Electronics
Technology Co., Ltd.
Nanmen Village, Hengken
Administrative Zone, Liaobu Town
Dongguan, Guangdong
P.R. China

Prüfzeichen *Test Mark*



Type Approved
Safety
Regular Production
Surveillance

www.tuv.com
ID 200000000

Geprüft nach *Tested acc. to*

EN 60691:2003+A1+A2

Zertifiziertes Produkt (Geräteidentifikation)
Certified Product (Product Identification)

Lizenzentgelte - Einheit
License Fee - Unit

Thermal Fuse (Thermal-links)

Type Designation:

Characteristic Temperatures

| | Tf(°C): | Th(°C): | Tm(°C): | |
|----------|---------|---------|---------|----|
| BTT 073C | 73 | 50 | 150 | 15 |
| BTT 077C | 77 | 50 | 150 | |
| BTT 084C | 84 | 50 | 150 | |
| BTT 094C | 94 | 65 | 150 | |
| BTT 099C | 99 | 71 | 150 | |
| BTT 113C | 113 | 85 | 150 | |
| BTT 121C | 121 | 95 | 160 | |
| BTT 128C | 128 | 102 | 160 | |
| BTT 133C | 133 | 105 | 160 | |
| BTT 142C | 142 | 110 | 160 | |
| BTT 157C | 157 | 130 | 175 | |
| BTT 172C | 172 | 145 | 190 | |
| BTT 192C | 192 | 165 | 300 | |
| BTT 216C | 216 | 190 | 300 | |
| BTT 240C | 240 | 190 | 300 | |

Continued on Page 0002



15

Dem Zertifikat liegt unsere Prüf- und Zertifizierungsordnung zugrunde und es bestätigt die Konformität des Produktes mit den oben genannten Standards und Prüfgrundlagen. Zusätzliche Anforderungen in Ländern, in denen das Produkt in Verkehr gebracht werden soll, müssen zusätzlich betrachtet werden. Die Herstellung des zertifizierten Produktes wird überwacht.

This certificate is based on our Testing and Certification Regulation and states the conformity of the product with the standards and testing requirements as indicated above. Any additional requirements in countries where the product is going to be marketed have to be considered additionally. The manufacturing of the certified product is subject to surveillance.

Zertifizierungsstelle

G.

TÜV Rheinland LGA Products GmbH - Tillystraße 2 - 90431 Nürnberg

Tel.: (+49/221)8 06 - 13 71 e-mail: cert-validity@de.tuv.com
Fax: (+49/221)8 06 - 39 35 http://www.tuv.com/safety

Zertifikat

Certificate



Zertifikat Nr. *Certificate No.*
R 50273319

Blatt *Page*
0002

Ihr Zeichen *Client Reference*

Unser Zeichen *Our Reference*

Ausstellungsdatum

Date of Issue
(day/mo/yr)

05-HUANGHA- 16056809 001 08.01.2014

Genehmigungsinhaber *License Holder*

Dongguan Better Electronics
Technology Co., Ltd.
Room No. 102, 103 of 3rd block
114 of 4th Block Innovtive Tech.
Park of Songshan Lake High-tech Ind.
Park, Dongguan, Guangdong
P.R. China

Fertigungsstätte *Manufacturing Plant*

Dongguan Better Electronics
Technology Co., Ltd.
Nanmen Village, Hengken
Administrative Zone, Liaobu Town
Dongguan, Guangdong
P.R. China

Prüfzeichen *Test Mark*

Geprüft nach *Tested acc. to*

EN 60691:2003+A1+A2



Zertifiziertes Produkt (Geräteidentifikation)
Certified Product (Product Identification)

Lizenzentgelte - Einheit
License Fee - Unit

Thermal Fuse (Thermal-links)

Continuation from Page 0001

Trademark : Better (logo)
Rated Voltage : AC 250V
Rated Current (Ir) : 10A or 15A
Transient Overload Current (Ip) : 150A or 225A
Interrupting Current (Ib) : 15A or 22,5A
Tracking Index : PTI 250
Circuit Conditions : resistive
Ambient Conditions : normal

Remark : The labelling requirements acc. to EU Directive 2001/95 have to be observed for distribution within the EEA. The installation has to be carried out according to installation instruction accompanying the products.

ANLAGE (Appendix) : 1

Dem Zertifikat liegt unsere Prüf- und Zertifizierungsordnung zugrunde und es bestätigt die Konformität des Produktes mit den oben genannten Standards und Prüfgrundlagen. Zusätzliche Anforderungen in Ländern, in denen das Produkt in Verkehr gebracht werden soll, müssen zusätzlich betrachtet werden. Die Herstellung des zertifizierten Produktes wird überwacht. This certificate is based on our Testing and Certification Regulation and states the conformity of the product with the standards and testing requirements as indicated above. Any additional requirements in countries where the product is going to be marketed have to be considered additionally. The manufacturing of the certified product is subject to surveillance.

Zertifizierungsstelle

TÜV Rheinland LGA Products GmbH - Tillystraße 2 - 90431 Nürnberg

Tel.: (+49/221)8 06 - 13 71 e-mail: cert-validity@de.tuv.com
Fax: (+49/221)8 06 - 39 35 http://www.tuv.com/safety



Zertifikat Certificate



Zertifikat Nr. *Certificate No.*
R 50273319

Blatt *Page*
0003

Ihr Zeichen *Client Reference*

Unser Zeichen *Our Reference*

Ausstellungsdatum

Date of Issue
(day/mo/yr)

05-RW- 16056809 002

30.07.2019

Genehmigungsinhaber *License Holder*

Dongguan Better Electronics
Technology Co., Ltd.
Room 601 of 16 Block, Xinzhu Yuan
No 4, Xinzhu Road, Songshanlake
Hightech Ind. Development Zone
Dongguan City, Guangdong Province
P. R. China

Fertigungsstätte *Manufacturing Plant*

Dongguan Better Electronics
Technology Co., Ltd. ,
Second Branch Factory
No.7, Sanhe Road, Hengkeng
Administrative Zone, Liaobu Town,
Dongguan City, Guangdong Province
P. R. China

Prüfzeichen *Test Mark*

Geprüft nach *Tested acc. to*

EN 60691:2003+A1+A2



Zertifiziertes Produkt *(Geräteidentifikation)*
Certified Product (Product Identification)

Lizenzentgelte - Einheit
License Fee - Unit

Thermal Fuse (Thermal-links)

as pages 0001-0002

Change

Address and name of factory : See above

Remark : The labelling requirements acc. to EU Directive
2001/95 have to be observed for distribution within the EEA.
The installation has to be carried out according to
installation instruction accompanying the products.

Dem Zertifikat liegt unsere Prüf- und Zertifizierungsordnung zugrunde und es bestätigt die Konformität des Produktes mit den oben genannten Standards und Prüfgrundlagen. Zusätzliche Anforderungen in Ländern, in denen das Produkt in Verkehr gebracht werden soll, müssen zusätzlich betrachtet werden. Die Herstellung des zertifizierten Produktes wird überwacht.
This certificate is based on our Testing and Certification Regulation and states the conformity of the product with the standards and testing requirements as indicated above. Any additional requirements in countries where the product is going to be marketed have to be considered additionally. The manufacturing of the certified product is subject to surveillance.

TÜV Rheinland LGA Products GmbH - Tillystraße 2 - 90431 Nürnberg

Tel.: (+49/221)8 06 - 13 71 e-mail: cert-validity@de.tuv.com

Fax: (+49/221)8 06 - 39 35 http://www.tuv.com/safety



Zertifikat *Certificate*



Zertifikat Nr. *Certificate No.*
R 50273319

Blatt *Page*
0004

Ihr Zeichen *Client Reference*

Unser Zeichen *Our Reference*

Ausstellungsdatum

Date of Issue
(day/mo/yr)

05-ZHANGVIVI- 16056809 003 27.08.2019

Genehmigungsinhaber *License Holder*

Dongguan Better Electronics
Technology Co., Ltd.
Room 601 of 16 Block, Xinzhu Yuan
No 4, Xinzhu Road, Songshanlake
Hightech Ind. Development Zone
Dongguan City, Guangdong Province
P. R. China

Fertigungsstätte *Manufacturing Plant*

Dongguan Better Electronics
Technology Co., Ltd. ,
Second Branch Factory
No.7, Sanhe Road, Hengkeng
Administrative Zone, Liaobu Town,
Dongguan City, Guangdong Province
P. R. China

Prüfzeichen *Test Mark*

Geprüft nach *Tested acc. to*
EN 60691:2016



Zertifiziertes Produkt *(Geräteidentifikation)*
Certified Product (Product Identification)

Lizenzentgelte - Einheit
License Fee - Unit

Thermal Fuse (Thermal-links)

as pages 0001-0003

Change

Test Requirement : see above

Remark : The labelling requirements acc. to EU Directive
2001/95 have to be observed for distribution within the EEA.
The installation has to be carried out according to
installation instruction accompanying the products.

*Dem Zertifikat liegt unsere Prüf- und Zertifizierungsordnung zugrunde und es bestätigt die Konformität
des Produktes mit den oben genannten Standards und Prüfgrundlagen. Zusätzliche Anforderungen
in Ländern, in denen das Produkt in Verkehr gebracht werden soll, müssen zusätzlich
betrachtet werden. Die Herstellung des zertifizierten Produktes wird überwacht.*

*This certificate is based on our Testing and Certification Regulation and states the conformity
of the product with the standards and testing requirements as indicated above. Any additional
requirements in countries where the product is going to be marketed have to be considered
additionally. The manufacturing of the certified product is subject to surveillance.*

TÜV Rheinland LGA Products GmbH - Tillystraße 2 - 90431 Nürnberg
Tel.: (+49/221)8 06 - 13 71 e-mail: cert-validity@de.tuv.com
Fax: (+49/221)8 06 - 39 35 <http://www.tuv.com/safety>



Zertifikat *Certificate*



Zertifikat Nr. *Certificate No.*
R 50273319

Blatt *Page*
0005

| <i>Ihr Zeichen Client Reference</i> | <i>Unser Zeichen Our Reference</i> | <i>Ausstellungsdatum</i> | <i>Date of Issue</i> (day/mo/yr) |
|-------------------------------------|------------------------------------|--------------------------|-------------------------------------|
| | 05-YFC- 16056809 005 | 09.06.2020 | |

Genehmigungsinhaber *License Holder*

Dongguan Better Electronics
Technology Co., Ltd.
Room 601 of 16 Block, Xinzhu Yuan
No 4, Xinzhu Road, Songshanlake
Hightech Ind. Development Zone
523808 Dongguan City Guangdong
P.R. China

Fertigungsstätte *Manufacturing Plant*

Dongguan Better Electronics
Technology Co., Ltd. ,
Second Branch Factory
No.7, Sanhe Road, Hengkeng
Administrative Zone, Liaobu Town,
Dongguan City Guangdong
P.R. China

Prüfzeichen *Test Mark*

Geprüft nach *Tested acc. to*
EN 60691:2016



Zertifiziertes Produkt *(Geräteidentifikation)*
Certified Product (Product Identification)

Lizenzentgelte - Einheit
License Fee - Unit

Thermal Fuse (Thermal-links)

as pages 0001-0004

Addition

| | | |
|------------------------------------|------------|---|
| Type Designation | : BTT 229C | 2 |
| Rated functioning temperature (Tf) | : 229°C | |
| Holding temperature (Th) | : 200°C | |
| Maximum temperature limit (Tm) | : 380°C | |

Remark : The labelling requirements acc. to EU Directive 2001/95 have to be observed for distribution within the EEA. The installation has to be carried out according to installation instruction accompanying the products.

2

Dem Zertifikat liegt unsere Prüf- und Zertifizierungsordnung zugrunde und es bestätigt die Konformität des Produktes mit den oben genannten Standards und Prüfgrundlagen. Zusätzliche Anforderungen in Ländern, in denen das Produkt in Verkehr gebracht werden soll, müssen zusätzlich betrachtet werden. Die Herstellung des zertifizierten Produktes wird überwacht. This certificate is based on our Testing and Certification Regulation and states the conformity of the product with the standards and testing requirements as indicated above. Any additional requirements in countries where the product is going to be marketed have to be considered additionally. The manufacturing of the certified product is subject to surveillance.

TÜV Rheinland LGA Products GmbH - Tillystraße 2 - 90431 Nürnberg
Tel.: (+49/221)8 06 - 13 71 e-mail: cert-validity@de.tuv.com
Fax: (+49/221)8 06 - 39 35 http://www.tuv.com/safety



ZEICHENGENEHMIGUNG MARKS APPROVAL

Dongguan Better Electronics
Technology Co., Ltd.
Room 601 of 16 Block, Xinzhu Yuan
No 4, Xinzhu Road
523808 DONGGUAN, Guangdong
CHINA

ist berechtigt, für ihr Produkt /
is authorized to use for their product

Temperatursicherung
Thermal link

die hier abgebildeten markenrechtlich geschützten Zeichen
für die ab Blatt 2 aufgeführten Typen zu benutzen /
the legally protected Marks as shown below for the types referred to on page 2 ff.



Geprüft und zertifiziert nach /
Tested and certified according to

DIN EN 60691 (VDE 0821):2017-04; EN 60691:2016
IEC 60691:2015



Aktenzeichen: 5015514-1171-0002 / 241963

File ref.:

Ausweis-Nr. 40041299

Blatt 1

Certificate No.

Page

Weitere Bedingungen siehe Rückseite und Folgeblätter /
further conditions see overleaf and following pages

Offenbach, 2014-12-12

(letzte Änderung / updated 2019-03-15)

VDE Prüf- und Zertifizierungsinstitut GmbH
VDE Testing and Certification Institute
Zertifizierungsstelle / *Certification*

M. Tasotti

VDE Zertifikate sind nur gültig bei Veröffentlichung unter:
VDE certificates are valid only when published on:

<http://www.vde.com/zertifikat>
<http://www.vde.com/certificate>

Name und Sitz des Genehmigungs-Inhabers / *Name and registered seat of the Certificate holder*

Dongguan Better Electronics Technology Co., Ltd., Room 601 of 16 Block, Xinzhu Yuan, No 4, Xinzhu Road,
523808 DONGGUAN, Guangdong, CHINA

Aktenzeichen / *File ref.*

5015514-1171-0002 / 241963 / TL3 / EUL

letzte Änderung / *updated*

2019-03-15

Datum / *Date*

2014-12-12

Dieses Blatt gilt nur in Verbindung mit Blatt 1 des Zeichengenehmigungsausweises Nr. 40041299.

This supplement is only valid in conjunction with page 1 of the Certificate No. 40041299.

Temperatursicherung

Thermal link

| Typ(en) / <i>Type(s)</i> | Bemessungsschalt- Temperatur <i>Rated functioning temperature</i> | Max. Grenztemperatur <i>Max. temperature limit</i> | Dauerbetriebstemperatur <i>r</i> <i>Holding temperature</i> |
|--------------------------|---|---|---|
| BTT73C | 73°C | 150°C | 50°C |
| BTT99C | 99°C | 150°C | 71°C |
| BTT113C | 113°C | 180°C | 85°C |
| BTT121C | 121°C | 180°C | 95°C |
| BTT133C | 133°C | 160°C | 105°C |
| BTT142C | 142°C | 160°C | 110°C |
| BTT157C | 157°C | 175°C | 130°C |
| BTT172C | 172°C | 190°C | 145°C |
| BTT184C | 184°C | 210°C | 160°C |
| BTT192C | 192°C | 300°C | 170°C |
| BTT216C | 216°C | 300°C | 190°C |
| BTT240C | 240°C | 300°C | 200°C |

Bemessungsspannung
Rated voltage

AC 250 V

Bemessungsstrom
Rated current

10 A; 15 A

Zur Verwendung in
For use in

ohmschen Stromkreisen $\cos \phi > 0,95$
resistive circuits $\cos \phi > 0,95$

induktiven Stromkreisen $0,6 < \cos \phi < 0,95$
inductive circuits $0,6 < \cos \phi < 0,95$

Kriechstromfestigkeit
Tracking resistance

PTI 175

Art der Montage
Method of mounting

Einbau
built-in

Fortsetzung siehe Blatt 3 /
continued on page 3

VDE Prüf- und Zertifizierungsinstitut Zeichengenehmigung

Ausweis-Nr. / Blatt /
Certificate No. / Page
40041299 3

Name und Sitz des Genehmigungs-Inhabers / *Name and registered seat of the Certificate holder*

Dongguan Better Electronics Technology Co., Ltd., Room 601 of 16 Block, Xinzhu Yuan, No 4, Xinzhu Road,
523808 DONGGUAN, Guangdong, CHINA

Aktenzeichen / *File ref.*

5015514-1171-0002 / 241963 / TL3 / EUL

letzte Änderung / *updated*

2019-03-15

Datum / *Date*

2014-12-12

Dieses Blatt gilt nur in Verbindung mit Blatt 1 des Zeichengenehmigungsausweises Nr. 40041299.

This supplement is only valid in conjunction with page 1 of the Certificate No. 40041299.

Dieser Zeichengenehmigungs-Ausweis bildet eine Grundlage für die EG-Konformitätserklärung und CE-Kennzeichnung durch den Hersteller oder dessen Bevollmächtigten und bescheinigt die Konformität mit den grundlegenden Schutzanforderungen der **EG-Niederspannungsrichtlinie 2014/35/EU**.

*This Marks Approval is a basis for the EC Declaration of Conformity and the CE Marking by the manufacturer or his agent and proves the conformity with the essential safety requirements of the **EC Low-Voltage Directive 2014/35/EU**.*

VDE Prüf- und Zertifizierungsinstitut GmbH

VDE Testing and Certification Institute

Fachgebiet TL3

Section TL3

VDE Prüf- und Zertifizierungsinstitut Zeichengenehmigung

Ausweis-Nr. / Beiblatt /
Certificate No. Supplement
40041299

Name und Sitz des Genehmigungs-Inhabers / *Name and registered seat of the Certificate holder*

Dongguan Better Electronics Technology Co., Ltd., Room 601 of 16 Block, Xinzhu Yuan, No 4, Xinzhu Road,
523808 DONGGUAN, Guangdong, CHINA

Aktenzeichen / *File ref.*

5015514-1171-0002 / 241963 / TL3 / EUL

letzte Änderung / *updated*

2019-03-15

Datum / *Date*

2014-12-12

Dieses Beiblatt ist Bestandteil des Zeichengenehmigungsausweises Nr. 40041299.

This supplement is part of the Certificate No. 40041299.

Temperatursicherung

Thermal link

Fertigungsstätte(n)

Place(s) of manufacture

Referenz/*Reference*

30017543

Dongguan Better Electronics
Technology Co., Ltd.
Nanmen Village
Hengkeng Administrative Zone
523413 LIAOBU TOWN, DONGGUAN
Guangdong
CHINA

VDE Prüf- und Zertifizierungsinstitut GmbH

VDE Testing and Certification Institute

Fachgebiet TL3

Section TL3



Name und Sitz des Genehmigungs-Inhabers / *Name and registered seat of the Certificate holder*

Dongguan Better Electronics Technology Co., Ltd., Room 601 of 16 Block, Xinzhu Yuan, No 4, Xinzhu Road,
523808 DONGGUAN, Guangdong, CHINA

Aktenzeichen / *File ref.*

5015514-1171-0002 / 241963 / TL3 / EUL

letzte Änderung / *updated*

2019-03-15

Datum / *Date*

2014-12-12

Dieses Blatt gilt nur in Verbindung mit Blatt 1 des Zeichengenehmigungsausweises Nr. 40041299.

This supplement is only valid in conjunction with page 1 of the Certificate No. 40041299.

Genehmigung zum Benutzen des auf Seite 1 abgebildeten markenrechtlich geschützten Zeichens des VDE:

Grundlage für die Benutzung sind die Allgemeinen Geschäftsbedingungen (AGB) der VDE Prüf- und Zertifizierungsinstitut GmbH (www.vde.com\AGB-Institut). Das Recht zur Benutzung erstreckt sich nur auf die bezeichnete Firma mit den genannten Fertigungsstätten und die oben aufgeführten Produkte mit den zugeordneten Bezeichnungen. Die Fertigungsstätte muss so eingerichtet sein, dass eine gleichmäßige Herstellung der geprüften und zertifizierten Ausführung gewährleistet ist.

Die Genehmigung ist so lange gültig wie die VDE-Bestimmungen gelten, die der Zertifizierung zugrunde gelegen haben, sofern sie nicht auf Grund anderer Bedingungen aus der VDE Prüf- und Zertifizierungsordnung (PM102) zurückgezogen werden muss.

Der Gültigkeitszeitraum einer VDE-GS-Zeichengenehmigung kann auf Antrag verlängert werden. Bei gesetzlichen und / oder normativen Änderungen kann die VDE-GS-Zeichengenehmigung ihre Gültigkeit zu einem früheren als dem angegebenen Datum verlieren.

Produkte, die das Biozid Dimethylfumarat (DMF) enthalten, dürfen gemäß der Kommissionsentscheidung 2009/251/EG nicht mehr in den Verkehr gebracht oder auf dem Markt bereitgestellt werden.

Der VDE-Zeichengenehmigungsausweis wird ausschließlich auf der ersten Seite unterzeichnet.

Approval to use the legally protected Mark of the VDE as shown on the first page:

Basis for the use are the general terms and conditions of the VDE Testing and Certification Institute (www.vde.com\terms-institute). The right to use the mark is granted only to the mentioned company with the named places of manufacture and the listed products with the related type references. The place of manufacture shall be equipped in a way that a constant manufacturing of the certified construction is assured.

The approval is valid as long as the VDE specifications are in force, on which the certification is based on, unless it is withdrawn according to the VDE Testing and Certification Procedure (PM102E).

The validity period of a VDE-GS-Mark Approval may be prolonged on request. In case of changes in legal and / or normative requirements, the validity period of a VDE-GS-Mark Approval may be shortened.

Products containing the biocide dimethylfumarate (DMF) may not be marketed or made available on the EC market according to the Commission Decision 2009/251/EC.

The approval is solely signed on the first page.

접수번호 : 14-053986-02
(Receipt No.)



전기용품안전인증서

Electrical Appliances Safety Certificate

안전인증번호 : SU05042-14003
(Certificate No.)

제조사명 : Dongguan Better Electronics Technoloy Co.,Ltd
(Manufacturer)

대표자명 : Han Lu
(President)

제조공장의 주소 : 2nd Industrial Zone, Nanmen Village, Hengkeng, Liao Bu Town,
(Factory Address) Dongguan, Guangdong, P.R.China

제품명 : 온도퓨즈
(Product) (Thermal fuse)

기본모델명 : BTT Tf:99℃ 250VAC 15A PTI 250
(Basic Model)

정격 : 250 VAC 15 A Tf:99 ℃ PTI 250
(Rating)

파생모델명 : See the attachment 2
(Series Model)

적용기준 : K60691(2011-12)
(Standard)

「전기용품안전 관리법 시행규칙」 제6조제2항에 따라 위의 전기용품에 대하여 안전인증
서를 발급합니다.

We Issue Electrical Appliances Safety Certification as above product by Article 6 Sectio
n 2 of the Electrical Appliances Safety Control Law Enforcement Regulation.

2014 년 12 월 30 일
Year month day



한국산업기술시험원장
KOREA TESTING LABORATORY



※ 이 인증서는 「전기용품안전 관리법」에 따른 전기용품 안전성 확인에 한정된 것이며, 그 밖의 다른
법률이 적용되는 제품의 경우에는 해당 법률에 따라 추가로 인증·허가 등을 받아야 합니다.

- 첨부 :
(Annex)
1. 안전관리부품 및 재질목록 (List of Critical Components)
 2. 기본모델·파생모델의 내용 (Descriptions of the basic and series model)
 3. 전기용품안전인증의 변경 현황 (Revisions Status)

첨부 1 : 안전관리부품 및 재질목록
 List of Critical Components

| 부품명(회로기호) Component(Part no.) | 제조사(상표명) Manufacturer(Brand) | 모델명(형식) Model(Type) | 정격 또는 특성 Rating or Characteristics | 인증마크 Tested by |
|--|---------------------------------|------------------------|---------------------------------------|-------------------|
| Not applicable | | | | |
| <p><input type="checkbox"/> 유의사항 (Attention) :</p> <p>1. 안전관리부품은 전기적인 안전에 직접적인 영향을 주는 부품으로서 안전인증기관이 정기공장검사 시 확인 관리 하는 사항입니다. 따라서 상기목록에 기재된 사항을 변경하거나 또는 복수등재를 원하시는 경우는 안전인증기관에 인증변경신청을 하여야 합니다.</p> <p><i>As the "Critical components" are parts in directly related with safety, these components shall be checked during a factory inspection by the certification body. In case of applying multiful listing or changing the items above, the certification revision shall be applied.</i></p> <p>2. 인증변경신청 없이 임의로 변경하는 경우는, 전기용품안전관리법 제 8 조제 1 항의 규정에 의한 안전인증취소 사유가 됨을 유의하시기 바랍니다.</p> <p><i>The Safety Certification will be cancelled under the Safety Control Law for Electrical Appliances, Paragraph 1 of Article 8 if the contents of the Certification is altered without our authorization.</i></p> | | | | |

FP511-10-00

첨부 2 : 기본모델 · 파생모델의 내용
General description of Certified Products

| 파생모델명 Derivative model | 기본모델과의 차이점 Differences between the basic and derivative model(s) |
|--|---|
| BTT Tf:73℃ 250VAC 15A PTI 250 | 동작온도 상이(73 ℃) |
| BTT Tf:77℃ 250VAC 15A PTI 250 | 동작온도 상이(77 ℃) |
| BTT Tf:84℃ 250VAC 15A PTI 250 | 동작온도 상이(84 ℃) |
| BTT Tf:94℃ 250VAC 15A PTI 250 | 동작온도 상이(94 ℃) |
| BTT Tf:73℃ 250VAC 10A PTI 250 | 동작온도 상이(73 ℃), 정격전류 상이(10 A) |
| BTT Tf:77℃ 250VAC 10A PTI 250 | 동작온도 상이(77 ℃), 정격전류 상이(10 A) |
| BTT Tf:84℃ 250VAC 10A PTI 250 | 동작온도 상이(84 ℃), 정격전류 상이(10 A) |
| BTT Tf:94℃ 250VAC 10A PTI 250 | 동작온도 상이(94 ℃), 정격전류 상이(10 A) |
| BTT Tf:99℃ 250VAC 10A PTI 250 | 정격전류 상이(10 A) |
| 제품특기사항 및 시험조건 Remarks & Test conditions | |
| <p>1. Test Report Ref. No. : 14-053986-02</p> | |
| <p><input type="checkbox"/> 본 제품의 시험내용에 관하여 문의하실 사항이 있으시면 아래 연락처로 문의하시기 바랍니다. 시험담당자: 전기전자본부 광융합/부품평가센터 박갑수 / (02)860-1427</p> <p><input type="checkbox"/> <i>If you have any question on product testing, please contact the person below:</i> <i>Job holder : Electrical and Electronic Division & Lighting Appliances & Electrical Components Testing Center, G.S , Park/ +82 2 860-1427</i></p> | |

FP511-09-00

첨부 3 : 전기용품안전인증의 변경 현황
Status of Certificate Revisions

| 변경발급 내용 Contents of Certificate Revisions |
|--|
| Not applicable |

FP511-11-00

접수번호 : 14-053986-03
(Receipt No.)



전기용품안전인증서

Electrical Appliances Safety Certificate

안전인증번호 : SU05042-14004
(Certificate No.)

제조사명 : Dongguan Better Electronics Technoloy Co.,Ltd
(Manufacturer)

대표자명 : Han Lu
(President)

제조공장의 주소 : 2nd Industrial Zone, Nanmen Village, Hengkeng, Liao Bu Town,
(Factory Address) Dongguan, Guangdong, P.R.China

제품명 : 온도퓨즈
(Product) (Thermal fuse)

기본모델명 : BTT Tf:113℃ 250VAC 15A PTI 250
(Basic Model)

정격 : 250 VAC 15 A Tf:113 ℃ PTI 250
(Rating)

파생모델명 : BTT Tf:113℃ 250VAC 10A PTI 250
(Series Model)

적용기준 : K60691(2011-12)
(Standard)

「전기용품안전 관리법 시행규칙」 제6조제2항에 따라 위의 전기용품에 대하여 안전인증서를 발급합니다.

We Issue Electrical Appliances Safety Certification as above product by Article 6 Section 2 of the Electrical Appliances Safety Control Law Enforcement Regulation.

2014 년 12 월 30 일
Year month day



한국산업기술시험원장
KOREA TESTING LABORATORY



* 이 인증서는 「전기용품안전 관리법」에 따른 전기용품 안전성 확인에 한정된 것이며, 그 밖의 다른 법률이 적용되는 제품의 경우에는 해당 법률에 따라 추가로 인증·허가 등을 받아야 합니다.

- 첨부 :
(Annex)
1. 안전관리부품 및 재질목록 (List of Critical Components)
 2. 기본모델·파생모델의 내용 (Descriptions of the basic and series model)
 3. 전기용품안전인증의 변경 현황 (Revisions Status)

첨부 1 : 안전관리부품 및 재질목록
 List of Critical Components

| 부품명(회로기호) Component(Part no.) | 제조사(상표명) Manufacturer(Brand) | 모델명(형식) Model(Type) | 정격 또는 특성 Rating or Characteristics | 인증마크 Tested by |
|--|---------------------------------|------------------------|---------------------------------------|-------------------|
| Not applicable | | | | |
| <p><input type="checkbox"/> 유의사항 (Attention) :</p> <p>1. 안전관리부품은 전기적인 안전에 직접적인 영향을 주는 부품으로서 안전인증기관이 정기공장검사 시 확인 관리 하는 사항입니다. 따라서 상기목록에 기재된 사항을 변경하거나 또는 복수등재를 원하시는 경우는 안전인증기관에 인증변경신청을 하여야 합니다.</p> <p><i>As the "Critical components" are parts in directly related with safety, these components shall be checked during a factory inspection by the certification body. In case of applying multiful listing or changing the items above, the certification revision shall be applied.</i></p> <p>2. 인증변경신청 없이 임의로 변경하는 경우는, 전기용품안전관리법 제 8 조제 1 항의 규정에 의한 안전인증취소 사유가 됨을 유의하시기 바랍니다.</p> <p><i>The Safety Certification will be cancelled under the Safety Control Law for Electrical Appliances, Paragraph 1 of Article 8 if the contents of the Certification is altered without our authorization.</i></p> | | | | |

FP511-10-00

첨부 2 : 기본모델 · 파생모델의 내용
 General description of Certified Products

| 파생모델명 Derivative model | 기본모델과의 차이점 Differences between the basic and derivative model(s) |
|--|---|
| BTT Tf:113℃ 250VAC 10A PTI 250 | 정격전류 상이(10 A) |
| 제품특기사항 및 시험조건 Remarks & Test conditions | |
| 1. Test Report Ref. No. : 14-053986-03 | |
| <p><input type="checkbox"/> 본 제품의 시험내용에 관하여 문의하실 사항이 있으시면 아래 연락처로 문의하시기 바랍니다. 시험담당자: 전기전자본부 광응합/부품평가센터 박갑수 / (02)860-1427</p> <p><input type="checkbox"/> <i>If you have any question on product testing, please contact the person below:</i> <i>Job holder : Electrical and Electronic Division & Lighting Appliances & Electrical Components Testing Center, G.S , Park/ +82 2 860-1427</i></p> | |

FP511-09-00

첨부 3 : 전기용품안전인증의 변경 현황
 Status of Certificate Revisions

| 변경발급 내용 Contents of Certificate Revisions |
|--|
| Not applicable |

FP511-11-00

접수번호 : 14-053986-04
(Receipt No.)



전기용품안전인증서

Electrical Appliances Safety Certificate

안전인증번호 : SU05042-14005
(Certificate No.)

제조사명 : Dongguan Better Electronics Technoloy Co.,Ltd
(Manufacturer)

대표자명 : Han Lu
(President)

제조공장의 주소 : 2nd Industrial Zone, Nanmen Village, Hengkeng, Liao Bu Town,
(Factory Address) Dongguan, Guangdong, P.R.China

제품명 : 온도퓨즈
(Product) (Thermal fuse)

기본모델명 : BTT Tf:157℃ 250VAC 15A PTI 250
(Basic Model)

정격 : 250 VAC 15 A Tf:157 ℃ PTI 250
(Rating)

파생모델명 : See the attachment 2
(Series Model)

적용기준 : K60691(2011-12)
(Standard)

「전기용품안전 관리법 시행규칙」 제6조제2항에 따라 위의 전기용품에 대하여 안전인증
서를 발급합니다.

We Issue Electrical Appliances Safety Certification as above product by Article 6 Sectio
n 2 of the Electrical Appliances Safety Control Law Enforcement Regulation.

2014 년 12 월 30 일
Year month day



한국산업기술시험원장
KOREA TESTING LABORATORY



* 이 인증서는 「전기용품안전 관리법」에 따른 전기용품 안전성 확인에 한정된 것이며, 그 밖의 다른
법률이 적용되는 제품의 경우에는 해당 법률에 따라 추가로 인증·허가 등을 받아야 합니다.

- 첨부 :
(Annex)
1. 안전관리부품 및 재질목록 (List of Critical Components)
 2. 기본모델·파생모델의 내용 (Descriptions of the basic and series model)
 3. 전기용품안전인증의 변경 현황 (Revisions Status)

첨부 1 : 안전관리부품 및 재질목록
 List of Critical Components

| 부품명(회로기호) Component(Part no.) | 제조사(상표명) Manufacturer(Brand) | 모델명(형식) Model(Type) | 정격 또는 특성 Rating or Characteristics | 인증마크 Tested by |
|---|---------------------------------|------------------------|---------------------------------------|-------------------|
| Not applicable | | | | |
| <p><input type="checkbox"/> 유의사항 (Attention) :</p> <p>1. 안전관리부품은 전기적인 안전에 직접적인 영향을 주는 부품으로서 안전인증기관이 정기공장검사 시 확인 관리 하는 사항입니다. 따라서 상기목록에 기재된 사항을 변경하거나 또는 복수등재를 원하시는 경우는 안전인증기관에 인증변경신청을 하여야 합니다.</p> <p><i>As the "Critical components" are parts in directly related with safety, these components shall be checked during a factory inspection by the certification body. In case of applying multiful listing or changing the items above, the certification revision shall be applied.</i></p> <p>2. 인증변경신청 없이 임의로 변경하는 경우는, 전기용품안전관리법 제 8 조제 1 항의 규정에 의한 안전인증취소 사유가 됨을 유의하시기 바랍니다.</p> <p><i>The Safety Certification will be cancelled under the Safety Control Law for Electrical Appliances, Paragraph 1 of Article 8 if the contents of the Certification is altered without our authorization.</i></p> | | | | |

FP511-10-00

첨부 2 : 기본모델 · 파생모델의 내용
General description of Certified Products

| 파생모델명 Derivative model | 기본모델과의 차이점 Differences between the basic and derivative model(s) |
|---|---|
| BTT Tf:121℃ 250VAC 15A PTI 250 | 동작온도 상이(121 ℃) |
| BTT Tf:128℃ 250VAC 15A PTI 250 | 동작온도 상이(128 ℃) |
| BTT Tf:133℃ 250VAC 15A PTI 250 | 동작온도 상이(133 ℃) |
| BTT Tf:142℃ 250VAC 15A PTI 250 | 동작온도 상이(142 ℃) |
| BTT Tf:121℃ 250VAC 10A PTI 250 | 동작온도 상이(121 ℃), 정격전류 상이(10 A) |
| BTT Tf:128℃ 250VAC 10A PTI 250 | 동작온도 상이(128 ℃), 정격전류 상이(10 A) |
| BTT Tf:133℃ 250VAC 10A PTI 250 | 동작온도 상이(133 ℃), 정격전류 상이(10 A) |
| BTT Tf:142℃ 250VAC 10A PTI 250 | 동작온도 상이(142 ℃), 정격전류 상이(10 A) |
| BTT Tf:157℃ 250VAC 10A PTI 250 | 정격전류 상이(10 A) |
| 제품특기사항 및 시험조건 Remarks & Test conditions | |
| 1. Test Report Ref. No. : 14-053986-04 | |
| <input type="checkbox"/> 본 제품의 시험내용에 관하여 문의하실 사항이 있으시면 아래 연락처로 문의하시기 바랍니다. 시험담당자: 전기전자본부 광융합/부품평가센터 박갑수 / (02)860-1427 <input type="checkbox"/> <i>If you have any question on product testing, please contact the person below:</i> <i>Job holder : Electrical and Electronic Division & Lighting Appliances & Electrical Components Testing Center, G.S , Park/ +82 2 860-1427</i> | |

FP511-09-00

첨부 3 : 전기용품안전인증의 변경 현황
Status of Certificate Revisions

| 변경발급 내용 Contents of Certificate Revisions |
|--|
| Not applicable |

FP511-11-00

접수번호 : 14-053986-05
(Receipt No.)



전기용품안전인증서

Electrical Appliances Safety Certificate

안전인증번호 : SU05042-14006
(Certificate No.)

제조사명 : Dongguan Better Electronics Technoloy Co.,Ltd
(Manufacturer)

대표자명 : Han Lu
(President)

제조공장의 주소 : 2nd Industrial Zone, Nanmen Village, Hengkeng, Liao Bu Town,
(Factory Address) Dongguan, Guangdong, P.R.China

제품명 : 온도퓨즈
(Product) (Thermal fuse)

기본모델명 : BTT Tf:192℃ 250VAC 15A PTI 250
(Basic Model)

정격 : 250 VAC 15 A Tf:192 ℃ PTI 250
(Rating)

파생모델명 : See the attachment 2
(Series Model)

적용기준 : K60691(2011-12)
(Standard)

「전기용품안전 관리법 시행규칙」 제6조제2항에 따라 위의 전기용품에 대하여 안전인증
서를 발급합니다.

We Issue Electrical Appliances Safety Certification as above product by Article 6 Sectio
n 2 of the Electrical Appliances Safety Control Law Enforcement Regulation.

2014 년 12 월 30 일
Year month day



한국산업기술시험원장
KOREA TESTING LABORATORY



* 이 인증서는 「전기용품안전 관리법」에 따른 전기용품 안전성 확인에 한정된 것이며, 그 밖의 다른
법률이 적용되는 제품의 경우에는 해당 법률에 따라 추가로 인증·허가 등을 받아야 합니다.

- 첨부 :
(Annex)
1. 안전관리부품 및 재질목록 (List of Critical Components)
 2. 기본모델·파생모델의 내용 (Descriptions of the basic and series model)
 3. 전기용품안전인증의 변경 현황 (Revisions Status)

첨부 1 : 안전관리부품 및 재질목록
List of Critical Components

| 부품명(회로기호) Component(Part no.) | 제조사(상표명) Manufacturer(Brand) | 모델명(형식) Model(Type) | 정격 또는 특성 Rating or Characteristics | 인증마크 Tested by |
|---|---------------------------------|------------------------|---------------------------------------|-------------------|
| Not applicable | | | | |
| <p><input type="checkbox"/> 유의사항 (Attention) :</p> <p>1. 안전관리부품은 전기적인 안전에 직접적인 영향을 주는 부품으로서 안전인증기관이 정기공장검사 시 확인 관리 하는 사항입니다. 따라서 상기목록에 기재된 사항을 변경하거나 또는 복수등재를 원하시는 경우는 안전인증기관에 인증변경신청을 하여야 합니다.</p> <p><i>As the "Critical components" are parts in directly related with safety, these components shall be checked during a factory inspection by the certification body. In case of applying multiful listing or changing the items above, the certification revision shall be applied.</i></p> <p>2. 인증변경신청 없이 임의로 변경하는 경우는, 전기용품안전관리법 제 8 조제 1 항의 규정에 의한 안전인증취소 사유가 됨을 유의하시기 바랍니다.</p> <p><i>The Safety Certification will be cancelled under the Safety Control Law for Electrical Appliances, Paragraph 1 of Article 8 if the contents of the Certification is altered without our authorization.</i></p> | | | | |

FP511-10-00

첨부 2 : 기본모델 · 파생모델의 내용
 General description of Certified Products

| 파생모델명 Derivative model | 기본모델과의 차이점 Differences between the basic and derivative model(s) |
|--|---|
| BTT Tf:172℃ 250VAC 15A PTI 250 | 동작온도 상이(172 ℃) |
| BTT Tf:172℃ 250VAC 10A PTI 250 | 동작온도 상이(172 ℃), 정격전류 상이(10 A) |
| BTT Tf:192℃ 250VAC 10A PTI 250 | 정격전류 상이(10 A) |
| 제품특기사항 및 시험조건 Remarks & Test conditions | |
| <p>1. Test Report Ref. No. : 14-053986-05</p> | |
| <p><input type="checkbox"/> 본 제품의 시험내용에 관하여 문의하실 사항이 있으시면 아래 연락처로 문의하시기 바랍니다. 시험담당자: 전기전자본부 광융합/부품평가센터 박갑수 / (02)860-1427 <input type="checkbox"/> <i>If you have any question on product testing, please contact the person below:</i> <i>Job holder : Electrical and Electronic Division & Lighting Appliances & Electrical Components Testing Center, G.S , Park/ +82 2 860-1427</i></p> | |

FP511-09-00

첨부 3 : 전기용품안전인증의 변경 현황
 Status of Certificate Revisions

| 변경발급 내용 Contents of Certificate Revisions |
|--|
| <p>Not applicable</p> |

FP511-11-00

접수번호 : 14-053986-01
(Receipt No.)



전기용품안전인증서

Electrical Appliances Safety Certificate

안전인증번호 : SU05042-14002
(Certificate No.)

제조사명 : Dongguan Better Electronics Technoloy Co.,Ltd
(Manufacturer)

대표자명 : Han Lu
(President)

제조공장의 주소 : 2nd Industrial Zone, Nanmen Village, Hengkeng, Liao Bu Town,
(Factory Address) Dongguan, Guangdong, P.R.China

제품명 : 온도퓨즈
(Product) (Thermal fuse)

기본모델명 : BTT Tf:240℃ 250VAC 15A PTI 250
(Basic Model)

정격 : 250 VAC 15 A Tf:240 ℃ PTI 250
(Rating)

파생모델명 : See the attachment 2
(Series Model)

적용기준 : K60691(2011-12)
(Standard)

「전기용품안전 관리법 시행규칙」 제6조제2항에 따라 위의 전기용품에 대하여 안전인증서를 발급합니다.

We Issue Electrical Appliances Safety Certification as above product by Article 6 Section 2 of the Electrical Appliances Safety Control Law Enforcement Regulation.

2014 년 12 월 30 일
Year month day



한국산업기술시험원장
KOREA TESTING LABORATORY



* 이 인증서는 「전기용품안전 관리법」에 따른 전기용품 안전성 확인에 한정된 것이며, 그 밖의 다른 법률이 적용되는 제품의 경우에는 해당 법률에 따라 추가로 인증·허가 등을 받아야 합니다.

- 첨부 :
(Annex)
1. 안전관리부품 및 재질목록 (List of Critical Components)
 2. 기본모델·파생모델의 내용 (Descriptions of the basic and series model)
 3. 전기용품안전인증의 변경 현황 (Revisions Status)

첨부 1 : 안전관리부품 및 재질목록
 List of Critical Components

| 부품명(회로기호) Component(Part no.) | 제조사(상표명) Manufacturer(Brand) | 모델명(형식) Model(Type) | 정격 또는 특성 Rating or Characteristics | 인증마크 Tested by |
|--|---------------------------------|------------------------|---------------------------------------|-------------------|
| Not applicable | | | | |
| <p><input type="checkbox"/> 유의사항 (Attention) :</p> <p>1. 안전관리부품은 전기적인 안전에 직접적인 영향을 주는 부품으로서 안전인증기관이 정기공장검사 시 확인 관리 하는 사항입니다. 따라서 상기목록에 기재된 사항을 변경하거나 또는 복수등재를 원하시는 경우는 안전인증기관에 인증변경신청을 하여야 합니다.</p> <p><i>As the "Critical components" are parts in directly related with safety, these components shall be checked during a factory inspection by the certification body. In case of applying multiful listing or changing the items above, the certification revision shall be applied.</i></p> <p>2. 인증변경신청 없이 임의로 변경하는 경우는, 전기용품안전관리법 제 8 조제 1 항의 규정에 의한 안전인증취소 사유가 됨을 유의하시기 바랍니다.</p> <p><i>The Safety Certification will be cancelled under the Safety Control Law for Electrical Appliances, Paragraph 1 of Article 8 if the contents of the Certification is altered without our authorization.</i></p> | | | | |

FP511-10-00

첨부 2 : 기본모델 · 파생모델의 내용
 General description of Certified Products

| 파생모델명 Derivative model | 기본모델과의 차이점 Differences between the basic and derivative model(s) |
|--|---|
| BTT Tf:216℃ 250VAC 15A PTI 250 | 동작온도 상이(216 ℃) |
| BTT Tf:216℃ 250VAC 10A PTI 250 | 동작온도 상이(216 ℃), 정격전류 상이(10 A) |
| BTT Tf:240℃ 250VAC 10A PTI 250 | 정격전류 상이(10 A) |
| 제품특기사항 및 시험조건 Remarks & Test conditions | |
| <p>1. Test Report Ref. No. : 14-053986-01</p> | |
| <p><input type="checkbox"/> 본 제품의 시험내용에 관하여 문의하실 사항이 있으시면 아래 연락처로 문의하시기 바랍니다. 시험담당자: 전기전자본부 광융합/부품평가센터 박갑수 / (02)860-1427 <input type="checkbox"/> <i>If you have any question on product testing, please contact the person below:</i> <i>Job holder : Electrical and Electronic Division & Lighting Appliances & Electrical Components Testing Center, G.S , Park/ +82 2 860-1427</i></p> | |

FP511-09-00

첨부 3 : 전기용품안전인증의 변경 현황
 Status of Certificate Revisions

| 변경발급 내용 Contents of Certificate Revisions |
|--|
| <p>Not applicable</p> |

FP511-11-00



適合証明書

証明書番号 Certificate No.
PSE14020831

Certificate of Conformity

申請者照会番号 Applicant Reference
CJP2013102001-0901

発行年月日 Date of Issue
2014年11月21日

申請者 Applicant

製造工場 Factory

DONGGUAN BETTER ELECTRONICS TECHNOLOGY CO.,LTD
ROOM 601 OF 16 BLOCK, XINZHUYUAN, NO 4,
XINZHU ROAD, SONGSHANLAKE HIGHTECH INDUSTRIAL DEVELOPMENT ZONE,
DONGGUAN CITY, GUANGDONG PROVINCE,
P.R.CHINA 523808

DONGGUAN BETTER ELECTRONICS TECHNOLOGY CO.,LTD
NANMEN VILLAGE, HENGKENG ADMINISTRATIVE ZONE LIAOBU TOWN,
DONGGUAN, GUANGDONG, P.R.CHINA 523413



検査の方法 Standard for Certificate

- 電気用品の技術基準の解釈 別表第十二 国際規格等に準拠した基準 J60691(H22)
- 施行規則別表第四 Appendix 4 of the Enforcement Regulations

特定電気用品名 :
Name of Specified Electrical Appliance and Material

温度ヒューズ
Thermal-link

型式の区分 :
Type Classification

(「添付書類」参照)
(Refer to Attachment)

モデル名 :
Model

BTT Tf: 184°C 250V AC 10A/ 250V AC 15A Resistive load

製造事業者 :
Manufacturer

DONGGUAN BETTER ELECTRONICS TECHNOLOGY CO.,LTD

証明書の有効期間 :
Validity of Certificate

2021年11月22日までに有効です。
This certificate is expired on Nov 22th, 2021

これは、上記申請者より申請のあった上記特定電気用品及び製造工場が、電気用品安全法第八条第一項に規定する技術基準及び同法第九条第二項の経済産業省令で定める基準に適合していることを証明するものです。

This is to certify that the above-mentioned Specified Electrical Appliances and Materials and the factory which the above-mentioned applicant applied for have been complied with the Technical Requirements stipulated by Article 8, Paragraph 1 of the Electrical Appliance and Material Safety Law and the requirements stipulated by the METI Ordinance specified in Article 9, paragraph 2 of the said law.

中国品質認証センター
CHINA QUALITY
CERTIFICATION CENTRE

氏名
Name

発行者
Issued by



中国100070北京市南四環西路188号9区
Section 9, No.188, Nansihuan Xilu, Beijing 100070, China

PJ 0004751



適合証明書

Certificate of Conformity

添付書類 Attachment 1

証明書番号(Certificate No.):
PSE14020831

発行日 Date of Issue:
2014年11月21日

【型式の区分 Type Classification】

特定電気用品:
(Name of Specified Electrical Appliance and Material)

温度ヒューズ
Thermal-link

| 要素 | 区分 |
|---------|---|
| 定格電圧 | (1) 125V以下のもの (2) 125Vを超えるもの |
| 定格電流 | (1) 5A以下のもの (2) 5Aを超え15A以下のもの (3) 15Aを超え30A以下のもの (4) 30Aを超えるもの |
| 公称動作温度 | (1) 80°C以下のもの (2) 80°Cを超え100°C以下のもの (3) 100°Cを超え120°C以下のもの (4) 120°Cを超え140°C以下のもの (5) 140°Cを超え160°C以下のもの (6) 160°Cを超え180°C以下のもの (7) 180°Cを超え200°C以下のもの (8) 200°Cを超え220°C以下のもの (9) 220°Cを超え240°C以下のもの (10) 240°Cを超え260°C以下のもの (11) 260°Cを超え280°C以下のもの (12) 280°Cを超え300°C以下のもの (13) 300°Cを超えるもの |
| 可溶体への通電 | (1) あるもの (2) ないもの |

中国品質認証センター
CHINA QUALITY
CERTIFICATION CENTRE

氏名
Name

発行者
Issued by



中国100070北京市南四環西路188号9区

Section 9, No.188, Nansihuan Xilu, Beijing 100070, China



適合証明書

Certificate of Conformity

添付書類 Attachment 2

証明書番号(Certificate No.):
PSE14020831

発行日 Date of Issue :
2014年11月21日

【 型式の区分 Type Classification 】

特定電気用品 :
(Name of Specified Electrical Appliance and Material)

温度ヒューズ
Thermal-link

| | |
|---------|---|
| 可溶体の主材料 | (1) ずず、鉛及びビスマスの合金のもの (2) ずず、鉛及びビスマスの合金以外の合金のもの (3) 合成樹脂又は有機化合物のもの (4) その他のもの |
| 容器 | (1) あるもの (2) ないもの |
| 端子 | (1) つめ形 (丸形を含む。) のもの (2) 線付きのもの (3) その他のもの |
| 可溶体の形状 | (1) 板状のもの (2) 塊状のもの (3) その他もの |

中国品質認証センター
CHINA QUALITY
CERTIFICATION CENTRE

氏名
Name

発行者
Issued by



中国100070北京市南四环西路188号9区

Section 9, No.188, Nansihuan Xilu, Beijing 100070, China



適合同等証明書

証明書番号 Statement No. Statement of Conformity Assessment
PSE20021602

| | |
|---|--|
| 申請者照会番号 Applicant Reference CJP2019102001-1840 | 発行年月日 Date of Issue 2020年1月16日 |
| 申請者 Applicant DONGGUAN BETTER ELECTRONICS TECHNOLOGY CO.,LTD ROOM 601 OF 16 BLOCK, XINZHUYUAN, NO 4, XINZHU ROAD, SONGSHANLAKE HIGHTECH INDUSTRIAL DEVELOPMENT ZONE, DONGGUAN CITY, GUANGDONG PROVINCE, P.R.CHINA 523808 | 製造工場 Factory DONGGUAN BETTER ELECTRONICS TECHNOLOGY CO.,LTD., SECOND BRANCH FACTORY NO.7, SANHE ROAD, HENGKENG ADMINISTRATIVE ZONE, LIAOBU TOWN, DONGGUAN CITY, GUANGDONG PROVINCE, P.R.C. 523413 |



検査の方法 Technical standards

・電気用品の技術上の基準を定める省令の解釈 別表第十二 国際規格等に準拠した基準

J60691(H28)

・施行規則別表第四

Appendix 4 of the Enforcement Regulations

| | |
|---|--|
| 特定電気用品名 : Name of Specified Electrical Appliance and Material | 温度ヒューズ Thermal-link |
| 型式の区分 : Type Classification | (「添付書類」参照) (Refer to Attachment) |
| モデル名 : Model | BTT Tf: 184°C 250V AC 10A / 250V AC 15A PTI 250 |
| 証明書の有効期間 : Validity of Statement | 2027年1月15日まで有効です。 This statement will expire on Jan.15th,2027 |

電気用品安全法第8条第1項に規定する技術基準及び同法第9条第2項の経済産業省令で定める基準(法第9条第1項第2号に係る検査に係るものに限る)に適合していることを証明します

I hereby certify that the product mentioned above complies with the technical requirements stipulated in Paragraph 1 of Article 8 of Electrical Appliances and Materials Safety Act (here under referred to as the Act) and the requirements defined by the ordinance of the Ministry of Economy, Trade and Industry based on Paragraph 2 of Article 9 of the Act (limited to Item 2 of Paragraph 1 of Article 9 for Inspection of the Act).

中国品質認証センター
CHINA QUALITY
CERTIFICATION CENTRE
〒100070

氏名
Name

陸梅

発行者
Issued by



中国100070北京市南四环西路188号9区
Section 9, No.188, Nansihuan Xilu, Beijing 100070 P.R. China

ST 0001144



適合同等証明書

添付書類 Attachment 1 Statement of Conformity Assessment

証明書番号(Statement No.):
PSE20021602

発行日 Date of Issue :
2020年1月16日

【 型式の区分 Type Classification 】

特定電気用品 :
(Name of Specified Electrical Appliance and Material)

温度ヒューズ
Thermal-link

| 要素 | 区分 |
|---------|---|
| 定格電圧 | (1) 125V以下のもの (2) 125Vを超えるもの |
| 定格電流 | (1) 5A以下のもの (2) 5Aを超え15A以下のもの (3) 15Aを超え30A以下のもの (4) 30Aを超えるもの |
| 公称動作温度 | (1) 80℃以下のもの (2) 80℃を超え100℃以下のもの (3) 100℃を超え120℃以下のもの (4) 120℃を超え140℃以下のもの (5) 140℃を超え160℃以下のもの (6) 160℃を超え180℃以下のもの (7) 180℃を超え200℃以下のもの (8) 200℃を超え220℃以下のもの (9) 220℃を超え240℃以下のもの (10) 240℃を超え260℃以下のもの (11) 260℃を超え280℃以下のもの (12) 280℃を超え300℃以下のもの (13) 300℃を超えるもの |
| 可溶体への通電 | (1) あるもの (2) ないもの |

中国品質認証センター
CHINA QUALITY
CERTIFICATION CENTRE
〒100070

氏名
Name

陸梅

発行者
Issued by



中国100070北京市南四环西路188号9区
Section 9, No.188, Nansihuan Xilu, Beijing 100070 P.R. China



適合同等証明書

添付書類 Attachment 2 Statement of Conformity Assessment

証明書番号(Statement No.) :
PSE20021602

発行日 Date of Issue :
2020年1月16日

【型式の区分 Type Classification】

特定電気用品 :

(Name of Specified Electrical Appliance and Material)

温度ヒューズ

Thermal-link

| | |
|---------|---|
| 可溶体の主材料 | (1) ずず、鉛及びビスマスの合金のもの (2) ずず、鉛及びビスマスの合金以外の合金のもの (3) 合成樹脂又は有機化合物のもの (4) その他のもの |
| 容器 | (1) あるもの (2) ないもの |
| 端子 | (1) つめ形(丸形を含む。)のもの (2) 線付きのもの (3) その他のもの |
| 可溶体の形状 | (1) 板状のもの (2) 塊状のもの (3) その他のもの |

中国品質認証センター
CHINA QUALITY
CERTIFICATION CENTRE
〒100070

中国100070北京市南四環西路188号9区

Section 9, No.188, Nansihuan Xilu, Beijing 100070 P.R. China

氏名
Name

陸梅

発行者
Issued by





適合同等証明書

証明書番号 Statement No.
PSE20021603

Statement of Conformity Assessment

| | |
|---|--|
| 申請者照会番号 Applicant Reference CJP2019102001-1912 | 発行年月日 Date of Issue 2020年3月10日 |
| 申請者 Applicant DONGGUAN BETTER ELECTRONICS TECHNOLOGY CO.,LTD ROOM 601 OF 16 BLOCK, XINZHUYUAN, NO 4, XINZHU ROAD, SONGSHANLAKE HIGHTECH INDUSTRIAL DEVELOPMENT ZONE, DONGGUAN CITY, GUANGDONG PROVINCE, P.R.CHINA 523808 | 製造工場 Factory DONGGUAN BETTER ELECTRONICS TECHNOLOGY CO.,LTD., SECOND BRANCH FACTORY NO.7, SANHE ROAD, HENGKENG ADMINISTRATIVE ZONE, LIAOBU TOWN, DONGGUAN CITY, GUANGDONG PROVINCE, P.R.C. 523413 |

検査の方法 Technical standards

・電気用品の技術上の基準を定める省令の解釈 別表第十二 国際規格等に準拠した基準

J60691(H28)

・施行規則別表第四

Appendix 4 of the Enforcement Regulations



| | |
|---|--|
| 特定電気用品名 : Name of Specified Electrical Appliance and Material | 温度ヒューズ Thermal-link |
| 型式の区分 : Type Classification | (「添付書類」参照) (Refer to Attachment) |
| モデル名 : Model | BTT Tf: 229°C 250V AC 10A / 250V AC 15A PTI 250 |
| 証明書の有効期間 : Validity of Statement | 2027年3月9日まで有効です。 This statement will expire on Mar.9th,2027 |

電気用品安全法第8条第1項に規定する技術基準及び同法第9条第2項の経済産業省令で定める基準(法第9条第1項第2号に係る検査に係るものに限る)に適合していることを証明します

I hereby certify that the product mentioned above complies with the technical requirements stipulated in Paragraph 1 of Article 8 of Electrical Appliances and Materials Safety Act (here under referred to as the Act) and the requirements defined by the ordinance of the Ministry of Economy, Trade and Industry based on Paragraph 2 of Article 9 of the Act (limited to Item 2 of Paragraph 1 of Article 9 for Inspection of the Act).

中国品質認証センター
CHINA QUALITY
CERTIFICATION CENTRE
〒100070

氏名
Name

陸梅

発行者
Issued by



中国100070北京市南四環西路188号9区
Section 9, No.188, Nansihuan Xilu, Beijing 100070 P.R. China

ST 0001182



適合同等証明書

添付書類 Attachment 1 Statement of Conformity Assessment

証明書番号(Statement No.):
PSE20021603

発行日 Date of Issue :
2020年3月10日

【 型式の区分 Type Classification 】

特定電気用品 :
(Name of Specified Electrical Appliance and Material)

温度ヒューズ
Thermal-link

| 要素 | 区分 |
|---------|-------------------------|
| 定格電圧 | (1) 125V以下のもの |
| | (2) 125Vを超えるもの |
| 定格電流 | (1) 5A以下のもの |
| | (2) 5Aを超え15A以下のもの |
| | (3) 15Aを超え30A以下のもの |
| | (4) 30Aを超えるもの |
| 公称動作温度 | (1) 80°C以下のもの |
| | (2) 80°Cを超え100°C以下のもの |
| | (3) 100°Cを超え120°C以下のもの |
| | (4) 120°Cを超え140°C以下のもの |
| | (5) 140°Cを超え160°C以下のもの |
| | (6) 160°Cを超え180°C以下のもの |
| | (7) 180°Cを超え200°C以下のもの |
| | (8) 200°Cを超え220°C以下のもの |
| | (9) 220°Cを超え240°C以下のもの |
| | (10) 240°Cを超え260°C以下のもの |
| | (11) 260°Cを超え280°C以下のもの |
| | (12) 280°Cを超え300°C以下のもの |
| | (13) 300°Cを超えるもの |
| 可溶体への通電 | (1) あるもの |
| | (2) ないもの |

中国品質認証センター
CHINA QUALITY
CERTIFICATION CENTRE
〒100070

氏名
Name

陸 楠

発行者
Issued by



中国100070北京市南四环西路188号9区
Section 9, No.188, Nansihuan Xilu, Beijing 100070 P.R. China



適合同等証明書

添付書類 Attachment 2 Statement of Conformity Assessment

証明書番号(Statement No.) :
PSE20021603

発行日 Date of Issue :
2020年3月10日

【 型式の区分 Type Classification 】

特定電気用品 :

(Name of Specified Electrical Appliance and Material)

温度ヒューズ

Thermal-link

| | |
|---------|---|
| 可溶体の主材料 | (1) すず、鉛及びビスマスの合金のもの (2) すず、鉛及びビスマスの合金以外の合金のもの (3) 合成樹脂又は有機化合物のもの (4) その他のもの |
| 容器 | (1) あるもの (2) ないもの |
| 端子 | (1) つめ形 (丸形を含む。) のもの (2) 線付きのもの (3) その他のもの |
| 可溶体の形状 | (1) 板状のもの (2) 塊状のもの (3) その他のもの |

中国品質認証センター
CHINA QUALITY
CERTIFICATION CENTRE
〒100070

氏名
Name

陸梅

発行者
Issued by



中国100070北京市南四环西路188号9区
Section 9, No.188, Nansihuan Xilu, Beijing 100070 P.R. China



適合証明書

Certificate of Conformity

証明書番号 Certificate No.

PSE13020660

申請者照会番号 Applicant Reference

CJP2013102001-0813

発行年月日 Date of Issue

2013年11月14日

申請者 Applicant

DONGGUAN BETTER ELECTRONIC TECHNOLOGY CO.,LTD

ROOM NO.102,103 OF 3RD BLOCK,114 OF 4TH BLOCK INNOVTIVE TECHNOLOGY PARK OF SONGSHAN LAKE HIGH-TECH INDUSTRY PARK DONGGUAN GUANGDONG CHINA

製造工場 Factor y

DONGGUAN BETTER ELECTRONIC TECHNOLOGY CO.,LTD

NANMEN VILLAGE, HENGKEN ADMINISTRATIVE ZONE, LIAOBU TOWN,DONGGUAN,GUANDONG. 523413,P.R.CHINA.

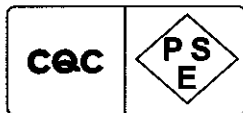

検査の方法 Standard for Certificate

・省令第2項技術基準：J60691(H22)

Article 2 of the Technical Requirements of the METI Ordinance

・施行規則別表第四

Appendix 4 of the Enforcement Regulations

特定電気用品名：

Name of Specified Electrical Appliance and Material

型式の区分：

Type Classification

モデル名：

Model

製造事業者：

Manufacturer

証明書の有効期間：

Validity of Certificate

温度ヒューズ

Thermal-link

(「添付書類」参照)

(Refer to Attachment)

BTT Tf: 73°C, 77°C

DONGGUAN BETTER ELECTRONIC TECHNOLOGY CO.,LTD

2020年11月13日までに有効です。

This certificate is expired on Nov. 13th, 2020

これは、上記申請者より申請のあった上記特定電気用品及び製造工場が、電気用品安全法第八条第一項に規定する技術基準及び同法第九条第二項の経済産業省令で定める基準に適合していることを証明するものです。

This is to certify that the above-mentioned Specified Electrical Appliances and Materials and the factory which the above-mentioned applicant applied for have been complied with the Technical Requirements stipulated by Article 8, Paragraph 1 of the Electrical Appliance and Material Safety Law and the requirements stipulated by the METI Ordinance specified in Article 9, paragraph 2 of the said law.

中国品質認証センター
CHINA QUALITY
CERTIFICATION CENTRE

氏名
Name

発行者
Issued by



中国100070北京市南四环西路188号9区

Section 9, No.188, Nansihuan Xilu, Beijing 100070, China

PJ 0003474



適合証明書

Certificate of Conformity

添付書類 Attachment 1

証明書番号(Certificate No.):
PSE13020660

発行日 Date of Issue :
2013年11月14日

【型式の区分 Type Classification】

特定電気用品 :
(Name of Specified Electrical Appliance and Material)

温度ヒューズ
Thermal-link

| 要素 | 区分 |
|---------|-----------------------|
| 定格電圧 | (1) 125V以下のもの |
| | (2) 125Vを超えるもの |
| 定格電流 | (1) 5A以下のもの |
| | (2) 5Aを超え15A以下のもの |
| | (3) 15Aを超え30A以下のもの |
| | (4) 30Aを超えるもの |
| 公称動作温度 | (1) 80℃以下のもの |
| | (2) 80℃を超え100℃以下のもの |
| | (3) 100℃を超え120℃以下のもの |
| | (4) 120℃を超え140℃以下のもの |
| | (5) 140℃を超え160℃以下のもの |
| | (6) 160℃を超え180℃以下のもの |
| | (7) 180℃を超え200℃以下のもの |
| | (8) 200℃を超え220℃以下のもの |
| | (9) 220℃を超え240℃以下のもの |
| | (10) 240℃を超え260℃以下のもの |
| | (11) 260℃を超え280℃以下のもの |
| | (12) 280℃を超え300℃以下のもの |
| | (13) 300℃を超えるもの |
| 可溶体への通電 | (1) あるもの |
| | (2) ないもの |

中国品質認証センター
CHINA QUALITY
CERTIFICATION CENTRE

氏名
Name

発行者
Issued by



中国100070北京市南四环西路188号9区
Section 9, No.188, Nansihuan Xilu, Beijing 100070, China



適合証明書

Certificate of Conformity

添付書類 Attachment 2

証明書番号(Certificate No.):
PSE13020660

発行日 Date of Issue :
2013 年 11 月 14 日

【 型式の区分 Type Classification 】

特定電気用品 :
(Name of Specified Electrical Appliance and Material)

温度ヒューズ
Thermal-link

| | |
|---------|---|
| 可溶体の主材料 | (1) ずず、鉛及びビスマスの合金のもの (2) ずず、鉛及びビスマスの合金以外の合金のもの (3) 合成樹脂又は有機化合物のもの (4) その他のもの |
| 容器 | (1) あるもの (2) ないもの |
| 端子 | (1) つめ形 (丸形を含む。) のもの (2) 線付きのもの (3) その他のもの |
| 可溶体の形状 | (1) 板状のもの (2) 塊状のもの (3) その他のもの |

中国品質認証センター
CHINA QUALITY
CERTIFICATION CENTRE

氏名
Name

発行者
Issued by



中国100070北京市南四环西路188号9区
Section 9, No.188, Nansihuan Xilu, Beijing 100070, China



適合証明書

Certificate of Conformity

証明書番号 Certificate No.

PSE13020659

申請者照会番号 Applicant Reference

CJP2013102001-0812

発行年月日 Date of Issue

2013年11月14日

申請者 Applicant

DONGGUAN BETTER ELECTRONIC TECHNOLOGY CO.,LTD

ROOM NO.102,103 OF 3RD BLOCK,114 OF 4TH BLOCK INNOVTIVE TECHNOLOGY PARK OF SONGSHAN LAKE HIGH-TECH INDUSTRY PARK DONGGUAN GUANGDONG CHINA

製造工場 Factor y

DONGGUAN BETTER ELECTRONIC TECHNOLOGY CO.,LTD

NANMEN VILLAGE, HENGKEN ADMINISTRATIVE ZONE, LIAOBU TOWN,DONGGUAN,GUANDONG. 523413,P.R.CHINA.



検査の方法 Standard for Certificate

・省令第2項技術基準：J60691(I122)

Article 2 of the Technical Requirements of the METI Ordinance

・施行規則別表第四

Appendix 4 of the Enforcement Regulations

特定電気用品名：

Name of Specified Electrical Appliance and Material

型式の区分：

Type Classification

モデル名：

Model

製造事業者：

Manufacturer

証明書の有効期間：

Validity of Certificate

温度ヒューズ

Thermal-link

(「添付書類」参照)

(Refer to Attachment)

BTTF: 84°C, 94°C, 99°C

DONGGUAN BETTER ELECTRONIC TECHNOLOGY CO.,LTD

2020年11月13日までに有効です。

This certificate is expired on Nov. 13th, 2020

これは、上記申請者より申請のあった上記特定電気用品及び製造工場が、電気用品安全法第八条第一項に規定する技術基準及び同法第九条第二項の経済産業省令で定める基準に適合していることを証明するものです。

This is to certify that the above-mentioned Specified Electrical Appliances and Materials and the factory which the above-mentioned applicant applied for have been complied with the Technical Requirements stipulated by Article 8, Paragraph 1 of the Electrical Appliance and Material Safety Law and the requirements stipulated by the METI Ordinance specified in Article 9, paragraph 2 of the said law.

中国品質認証センター
CHINA QUALITY
CERTIFICATION CENTRE

氏名
Name

発行者
Issued by



中国100070北京市南四环西路188号9区

Section 9, No.188, Nansihuan Xilu, Beijing 100070, China

PJ 0003476



適合証明書

Certificate of Conformity

添付書類 Attachment 1

証明書番号(Certificate No.):
PSE13020659

発行日 Date of Issue :
2013年11月14日

【型式の区分 Type Classification】

特定電気用品 :
(Name of Specified Electrical Appliance and Material)

温度ヒューズ
Thermal-link

| 要素 | 区分 |
|---------|-----------------------|
| 定格電圧 | (1) 125V以下のもの |
| | (2) 125Vを超えるもの |
| 定格電流 | (1) 5A以下のもの |
| | (2) 5Aを超え15A以下のもの |
| | (3) 15Aを超え30A以下のもの |
| | (4) 30Aを超えるもの |
| 公称動作温度 | (1) 80℃以下のもの |
| | (2) 80℃を超え100℃以下のもの |
| | (3) 100℃を超え120℃以下のもの |
| | (4) 120℃を超え140℃以下のもの |
| | (5) 140℃を超え160℃以下のもの |
| | (6) 160℃を超え180℃以下のもの |
| | (7) 180℃を超え200℃以下のもの |
| | (8) 200℃を超え220℃以下のもの |
| | (9) 220℃を超え240℃以下のもの |
| | (10) 240℃を超え260℃以下のもの |
| | (11) 260℃を超え280℃以下のもの |
| | (12) 280℃を超え300℃以下のもの |
| | (13) 300℃を超えるもの |
| 可溶体への通電 | (1) あるもの |
| | (2) ないもの |

中国品質認証センター
CHINA QUALITY
CERTIFICATION CENTRE

氏名
Name

発行者
Issued by



中国100070北京市南四环西路188号9区
Section 9, No.188, Nansihuan Xilu, Beijing 100070, China



適合証明書

Certificate of Conformity

添付書類 Attachment 2

証明書番号(Certificate No.):

PSE13020659

発行日 Date of Issue:

2013年11月14日

【 型式の区分 Type Classification 】

特定電気用品:

(Name of Specified Electrical Appliance and Material)

温度ヒューズ

Thermal-link

| | |
|---------|---------------------------|
| 可溶体の主材料 | (1) ずず、鉛及びビスマスの合金のもの |
| | (2) ずず、鉛及びビスマスの合金以外の合金のもの |
| | (3) 合成樹脂又は有機化合物のもの |
| | (4) その他のもの |
| 容器 | (1) あるもの |
| | (2) ないもの |
| 端子 | (1) つめ形 (丸形を含む。) のもの |
| | (2) 線付きのもの |
| | (3) その他のもの |
| 可溶体の形状 | (1) 板状のもの |
| | (2) 塊状のもの |
| | (3) その他のもの |

中国品質認証センター
CHINA QUALITY
CERTIFICATION CENTRE

氏名
Name

発行者
Issued by



中国100070北京市南四环西路188号9区
Section 9, No.188, Nansihuan Xilu, Beijing 100070, China



適合証明書

Certificate of Conformity

証明書番号 Certificate No.
PSE13020658

申請者照会番号 Applicant Reference
CJP2013102001-0811

発行年月日 Date of Issue
2013年11月14日

| | |
|---|---|
| 申請者 Applicant | 製造工場 Factory |
| DONGGUAN BETTER ELECTRONIC TECHNOLOGY CO.,LTD | DONGGUAN BETTER ELECTRONIC TECHNOLOGY CO.,LTD |
| ROOM NO.102,103 OF 3RD BLOCK,114 OF 4TH BLOCK INNOVTIVE TECHNOLOGY PARK OF SONGSHAN LAKE HIGH-TECH INDUSTRY PARK DONGGUAN GUANGDONG CHINA | NANMEN VILLAGE, HENGKEN ADMINISTRATIVE ZONE, LIAOBU TOWN,DONGGUAN,GUANDONG. 523413,P.R.CHINA. |



検査の方法 Standard for Certificate

- 省令第2項技術基準：J60691(H22)
Article 2 of the Technical Requirements of the METI Ordinance
- 施行規則別表第四
Appendix 4 of the Enforcement Regulations

特定電気用品名：
Name of Specified Electrical Appliance and Material

温度ヒューズ
Thermal-link

型式の区分：
Type Classification

(「添付書類」参照)
(Refer to Attachment)

モデル名：
Model

BTTTF: 113°C

製造事業者：
Manufacturer

DONGGUAN BETTER ELECTRONIC TECHNOLOGY CO.,LTD

証明書の有効期間：
Validity of Certificate

2020年11月13日までに有効です。
This certificate is expired on Nov. 13th, 2020

これは、上記申請者より申請のあった上記特定電気用品及び製造工場が、電気用品安全法第八条第一項に規定する技術基準及び同法第九条第二項の経済産業省令で定める基準に適合していることを証明するものです。

This is to certify that the above-mentioned Specified Electrical Appliances and Materials and the factory which the above-mentioned applicant applied for have been complied with the Technical Requirements stipulated by Article 8, Paragraph 1 of the Electrical Appliance and Material Safety Law and the requirements stipulated by the METI Ordinance specified in Article 9, paragraph 2 of the said law.

中国品質認証センター
CHINA QUALITY
CERTIFICATION CENTRE

氏名
Name

発行者
Issued by



中国100070北京市南四环西路188号9区
Section 9, No.188, Nansihuan Xilu, Beijing 100070, China

PJ 0003480



適合証明書

Certificate of Conformity

添付書類 Attachment 1

証明書番号(Certificate No.):
PSE13020658

発行日 Date of Issue :
2013年11月14日

【型式の区分 Type Classification】

特定電気用品:

(Name of Specified Electrical Appliance and Material)

温度ヒューズ

Thermal-link

| 要素 | 区分 |
|---------|-----------------------|
| 定格電圧 | (1) 125V以下のもの |
| | (2) 125Vを超えるもの |
| 定格電流 | (1) 5A以下のもの |
| | (2) 5Aを超え15A以下のもの |
| | (3) 15Aを超え30A以下のもの |
| | (4) 30Aを超えるもの |
| 公称動作温度 | (1) 80℃以下のもの |
| | (2) 80℃を超え100℃以下のもの |
| | (3) 100℃を超え120℃以下のもの |
| | (4) 120℃を超え140℃以下のもの |
| | (5) 140℃を超え160℃以下のもの |
| | (6) 160℃を超え180℃以下のもの |
| | (7) 180℃を超え200℃以下のもの |
| | (8) 200℃を超え220℃以下のもの |
| | (9) 220℃を超え240℃以下のもの |
| | (10) 240℃を超え260℃以下のもの |
| | (11) 260℃を超え280℃以下のもの |
| | (12) 280℃を超え300℃以下のもの |
| | (13) 300℃を超えるもの |
| 可溶体への通電 | (1) あるもの |
| | (2) ないもの |

中国品質認証センター
CHINA QUALITY
CERTIFICATION CENTRE

氏名
Name

発行者
Issued by



中国100070北京市南四环西路188号9区
Section 9, No.188, Nansihuan Xilu, Beijing 100070, China



適合証明書

Certificate of Conformity

添付書類 Attachment 2

証明書番号(Certificate No.):
PSE13020658

発行日 Date of Issue :
2013 年 11 月 14 日

【 型式の区分 Type Classification 】

特定電気用品 :
(Name of Specified Electrical Appliance and Material)

温度ヒューズ
Thermal-link

| | |
|---------|---|
| 可溶体の主材料 | (1) ずず、鉛及びビスマスの合金のもの (2) ずず、鉛及びビスマスの合金以外の合金のもの (3) 合成樹脂又は有機化合物のもの (4) その他のもの |
| 容器 | (1) あるもの (2) ないもの |
| 端子 | (1) つめ形 (丸形を含む。) のもの (2) 線付きのもの (3) その他のもの |
| 可溶体の形状 | (1) 板状のもの (2) 塊状のもの (3) その他もの |

中国品質認証センター
CHINA QUALITY
CERTIFICATION CENTRE

氏名
Name

発行者
Issued by



中国100070北京市南四环西路188号9区
Section 9, No.188, Nansihuan Xilu, Beijing 100070, China



適合証明書

Certificate of Conformity

証明書番号 Certificate No.

PSE13020657

申請者照会番号 Applicant Reference

CJP2013102001-0810

発行年月日 Date of Issue

2013年11月14日

申請者 Applicant

DONGGUAN BETTER ELECTRONIC TECHNOLOGY CO.,LTD
ROOM NO.102,103 OF 3RD BLOCK,114 OF 4TH BLOCK INNOVTIVE TECHNOLOGY PARK OF SONGSHAN LAKE HIGH-TECH INDUSTRY PARK DONGGUAN GUANGDONG CHINA

製造工場 Factory

DONGGUAN BETTER ELECTRONIC TECHNOLOGY CO.,LTD
NANMEN VILLAGE, HENGKEN ADMINISTRATIVE ZONE, LIAOBU TOWN,DONGGUAN,GUANDONG. 523413,P.R.CHINA.

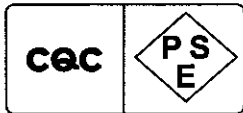

検査の方法 Standard for Certificate

・省令第2項技術基準：J60691(I122)

Article 2 of the Technical Requirements of the METI Ordinance

・施行規則別表第四

Appendix 4 of the Enforcement Regulations

特定電気用品名：

Name of Specified Electrical Appliance and Material

温度ヒューズ

Thermal-link

型式の区分：

Type Classification

(「添付書類」参照)

(Refer to Attachment)

モデル名：

Model

BTTTf: 121°C, 128°C, 133°C

製造事業者：

Manufacturer

DONGGUAN BETTER ELECTRONIC TECHNOLOGY CO.,LTD

証明書の有効期間：

Validity of Certificate

2020年11月13日までに有効です。

This certificate is expired on Nov. 13th, 2020

これは、上記申請者より申請のあった上記特定電気用品及び製造工場が、電気用品安全法第八条第一項に規定する技術基準及び同法第九条第二項の経済産業省令で定める基準に適合していることを証明するものです。

This is to certify that the above-mentioned Specified Electrical Appliances and Materials and the factory which the above-mentioned applicant applied for have been complied with the Technical Requirements stipulated by Article 8, Paragraph 1 of the Electrical Appliance and Material Safety Law and the requirements stipulated by the METI Ordinance specified in Article 9, paragraph 2 of the said law.

中国品質認証センター
CHINA QUALITY
CERTIFICATION CENTRE

氏名
Name

発行者
Issued by



中国100070北京市南四环西路188号9区

Section 9, No.188, Nansihuan Xilu, Beijing 100070, China

PJ 0003478



適合証明書

Certificate of Conformity

添付書類 Attachment 1

証明書番号(Certificate No.) :
PSE13020657

発行日 Date of Issue :
2013年11月14日

【型式の区分 Type Classification】

特定電気用品 :
(Name of Specified Electrical Appliance and Material)

温度ヒューズ
Thermal-link

| 要素 | 区分 |
|---------|-----------------------|
| 定格電圧 | (1) 125V以下のもの |
| | (2) 125Vを超えるもの |
| 定格電流 | (1) 5A以下のもの |
| | (2) 5Aを超え15A以下のもの |
| | (3) 15Aを超え30A以下のもの |
| | (4) 30Aを超えるもの |
| 公称動作温度 | (1) 80℃以下のもの |
| | (2) 80℃を超え100℃以下のもの |
| | (3) 100℃を超え120℃以下のもの |
| | (4) 120℃を超え140℃以下のもの |
| | (5) 140℃を超え160℃以下のもの |
| | (6) 160℃を超え180℃以下のもの |
| | (7) 180℃を超え200℃以下のもの |
| | (8) 200℃を超え220℃以下のもの |
| | (9) 220℃を超え240℃以下のもの |
| | (10) 240℃を超え260℃以下のもの |
| | (11) 260℃を超え280℃以下のもの |
| | (12) 280℃を超え300℃以下のもの |
| | (13) 300℃を超えるもの |
| 可溶体への通電 | (1) あるもの |
| | (2) ないもの |

中国品質認証センター
CHINA QUALITY
CERTIFICATION CENTRE

氏名
Name

発行者
Issued by



中国100070北京市南四环西路188号9区
Section 9, No.188, Nansihuan Xilu, Beijing 100070, China



適合証明書

Certificate of Conformity

添付書類 Attachment 2

証明書番号(Certificate No.):
PSE13020657

発行日 Date of Issue :
2013 年 11 月 14 日

【 型式の区分 Type Classification 】

特定電気用品 :
(Name of Specified Electrical Appliance and Material)

温度ヒューズ
Thermal-link

| | |
|---------|---|
| 可溶体の主材料 | (1) ずず、鉛及びビスマスの合金のもの (2) ずず、鉛及びビスマスの合金以外の合金のもの (3) 合成樹脂又は有機化合物のもの (4) その他のもの |
| 容器 | (1) あるもの (2) ないもの |
| 端子 | (1) つめ形（丸形を含む。）のもの (2) 線付きのもの (3) その他のもの |
| 可溶体の形状 | (1) 板状のもの (2) 塊状のもの (3) その他もの |

中国品質認証センター
CHINA QUALITY
CERTIFICATION CENTRE

氏名
Name

発行者
Issued by



中国100070北京市南四环西路188号9区
Section 9, No.188, Nansihuan Xilu, Beijing 100070, China



適合証明書

Certificate of Conformity

証明書番号 Certificate No.

PSE13020656

| | | | |
|-----------------------------|--|---------------------|--|
| 申請者照会番号 Applicant Reference | CJP2013102001-0809 | 発行年月日 Date of Issue | 2013年11月14日 |
| 申請者 Applicant | DONGGUAN BETTER ELECTRONIC TECHNOLOGY CO.,LTD ROOM NO.102,103 OF 3RD BLOCK,114 OF 4TH BLOCK INNOVTIVE TECHNOLOGY PARK OF SONGSHAN LAKE HIGH-TECH INDUSTRY PARK DONGGUAN GUANGDONG CHINA | 製造工場 Factor y | DONGGUAN BETTER ELECTRONIC TECHNOLOGY CO.,LTD NANMEN VILLAGE, HENGKEN ADMINISTRATIVE ZONE, LIAOBU TOWN,DONGGUAN,GUANDONG. 523413,P.R.CHINA. |

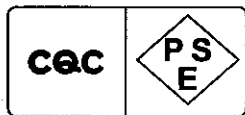

検査の方法 Standard for Certificate

・省令第2項技術基準：J60691(H22)

Article 2 of the Technical Requirements of the METI Ordinance

・施行規則別表第四

Appendix 4 of the Enforcement Regulations

| | |
|---|---|
| 特定電気用品名： Name of Specified Electrical Appliance and Material | 温度ヒューズ Thermal-link |
| 型式の区分： Type Classification | (「添付書類」参照) (Refer to Attachment) |
| モデル名： Model | BITTLE: 142°C, 157°C |
| 製造事業者： Manufacturer | DONGGUAN BETTER ELECTRONIC TECHNOLOGY CO.,LTD |
| 証明書の有効期間： Validity of Certificate | 2020年11月13日までに有効です。 This certificate is expired on Nov. 13th, 2020 |

これは、上記申請者より申請のあった上記特定電気用品及び製造工場が、電気用品安全法第八条第一項に規定する技術基準及び同法第九条第二項の経済産業省令で定める基準に適合していることを証明するものです。

This is to certify that the above-mentioned Specified Electrical Appliances and Materials and the factory which the above-mentioned applicant applied for have been complied with the Technical Requirements stipulated by Article 8, Paragraph 1 of the Electrical Appliance and Material Safety Law and the requirements stipulated by the METI Ordinance specified in Article 9, paragraph 2 of the said law.

中国品質認証センター
CHINA QUALITY
CERTIFICATION CENTRE

氏名
Name

発行者
Issued by



中国100070北京市南四环西路188号9区
Section 9, No.188, Nansihuan Xilu, Beijing 100070, China

PJ 0003486



適合証明書

Certificate of Conformity

添付書類 Attachment 1

証明書番号(Certificate No.):
PSE13020656

発行日 Date of Issue:
2013年11月14日

【型式の区分 Type Classification】

特定電気用品:
(Name of Specified Electrical Appliance and Material)

温度ヒューズ
Thermal-link

| 要素 | 区分 |
|---------|-----------------------|
| 定格電圧 | (1) 125V以下のもの |
| | (2) 125Vを超えるもの |
| 定格電流 | (1) 5A以下のもの |
| | (2) 5Aを超え15A以下のもの |
| | (3) 15Aを超え30A以下のもの |
| | (4) 30Aを超えるもの |
| 公称動作温度 | (1) 80℃以下のもの |
| | (2) 80℃を超え100℃以下のもの |
| | (3) 100℃を超え120℃以下のもの |
| | (4) 120℃を超え140℃以下のもの |
| | (5) 140℃を超え160℃以下のもの |
| | (6) 160℃を超え180℃以下のもの |
| | (7) 180℃を超え200℃以下のもの |
| | (8) 200℃を超え220℃以下のもの |
| | (9) 220℃を超え240℃以下のもの |
| | (10) 240℃を超え260℃以下のもの |
| | (11) 260℃を超え280℃以下のもの |
| | (12) 280℃を超え300℃以下のもの |
| | (13) 300℃を超えるもの |
| 可溶体への通電 | (1) あるもの |
| | (2) ないもの |

中国品質認証センター
CHINA QUALITY
CERTIFICATION CENTRE

氏名
Name

発行者
Issued by



中国100070北京市南四环西路188号9区
Section 9, No.188, Nansihuan Xilu, Beijing 100070, China



適合証明書

Certificate of Conformity

添付書類 Attachment 2

証明書番号(Certificate No.):
PSE13020656

発行日 Date of Issue :
2013 年 11 月 14 日

【 型式の区分 Type Classification 】

特定電気用品 :
(Name of Specified Electrical Appliance and Material)

温度ヒューズ
Thermal-link

| | |
|---------|---|
| 可溶体の主材料 | (1) ずず、鉛及びビスマスの合金のもの (2) ずず、鉛及びビスマスの合金以外の合金のもの (3) 合成樹脂又は有機化合物のもの (4) その他のもの |
| 容器 | (1) あるもの (2) ないもの |
| 端子 | (1) つめ形（丸形を含む。）のもの (2) 線付きのもの (3) その他のもの |
| 可溶体の形状 | (1) 板状のもの (2) 塊状のもの (3) その他もの |

中国品質認証センター
CHINA QUALITY
CERTIFICATION CENTRE

氏名
Name

発行者
Issued by



中国100070北京市南四环西路188号9区
Section 9, No.188, Nansihuan Xilu, Beijing 100070, China



適合証明書

Certificate of Conformity

証明書番号 Certificate No.

PSE13020655

申請者照会番号 Applicant Reference

CJP2013102001-0808

発行年月日 Date of Issue

2013年11月14日

申請者 Applicant

DONGGUAN BETTER ELECTRONIC TECHNOLOGY CO.,LTD

ROOM NO.102,103 OF 3RD BLOCK,114 OF 4TH BLOCK INNOVATIVE TECHNOLOGY PARK OF SONGSHAN LAKE HIGH-TECH INDUSTRY PARK DONGGUAN GUANGDONG CHINA

製造工場 Factor y

DONGGUAN BETTER ELECTRONIC TECHNOLOGY CO.,LTD

NANMEN VILLAGE, HENGKEN ADMINISTRATIVE ZONE, LIAOBU TOWN,DONGGUAN,GUANDONG. 523413,P.R.CHINA.

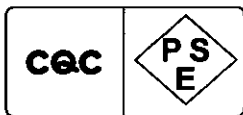

検査の方法 Standard for Certificate

・省令第2項技術基準：J60691(H22)

Article 2 of the Technical Requirements of the METI Ordinance

・施行規則別表第四

Appendix 4 of the Enforcement Regulations

特定電気用品名：

Name of Specified Electrical Appliance and Material

型式の区分：

Type Classification

モデル名：

Model

製造事業者：

Manufacturer

証明書の有効期間：

Validity of Certificate

温度ヒューズ

Thermal-link

(「添付書類」参照)

(Refer to Attachment)

BTT Tf: 172°C

DONGGUAN BETTER ELECTRONIC TECHNOLOGY CO.,LTD

2020年11月13日までに有効です。

This certificate is expired on Nov. 13th, 2020

これは、上記申請者より申請のあった上記特定電気用品及び製造工場が、電気用品安全法第八条第一項に規定する技術基準及び同法第九条第二項の経済産業省令で定める基準に適合していることを証明するものです。

This is to certify that the above-mentioned Specified Electrical Appliances and Materials and the factory which the above-mentioned applicant applied for have been complied with the Technical Requirements stipulated by Article 8, Paragraph 1 of the Electrical Appliance and Material Safety Law and the requirements stipulated by the METI Ordinance specified in Article 9, paragraph 2 of the said law.

中国品質認証センター
CHINA QUALITY
CERTIFICATION CENTRE

氏名
Name

発行者
Issued by



中国100070北京市南四环西路188号9区

Section 9, No.188, Nansihuan Xilu, Beijing 100070, China

PJ 0003482



適合証明書

Certificate of Conformity

添付書類 Attachment 1

証明書番号(Certificate No.):
PSE13020655

発行日 Date of Issue :
2013 年 11 月 14 日

【型式の区分 Type Classification】

特定電気用品 :
(Name of Specified Electrical Appliance and Material)

温度ヒューズ
Thermal-link

| 要素 | 区分 |
|---------|-----------------------|
| 定格電圧 | (1) 125V以下のもの |
| | (2) 125Vを超えるもの |
| 定格電流 | (1) 5A以下のもの |
| | (2) 5Aを超え15A以下のもの |
| | (3) 15Aを超え30A以下のもの |
| | (4) 30Aを超えるもの |
| 公称動作温度 | (1) 80℃以下のもの |
| | (2) 80℃を超え100℃以下のもの |
| | (3) 100℃を超え120℃以下のもの |
| | (4) 120℃を超え140℃以下のもの |
| | (5) 140℃を超え160℃以下のもの |
| | (6) 160℃を超え180℃以下のもの |
| | (7) 180℃を超え200℃以下のもの |
| | (8) 200℃を超え220℃以下のもの |
| | (9) 220℃を超え240℃以下のもの |
| | (10) 240℃を超え260℃以下のもの |
| | (11) 260℃を超え280℃以下のもの |
| | (12) 280℃を超え300℃以下のもの |
| | (13) 300℃を超えるもの |
| 可溶体への通電 | (1) あるもの |
| | (2) ないもの |

中国品質認証センター
CHINA QUALITY
CERTIFICATION CENTRE

氏名
Name

発行者
Issued by



中国100070北京市南四环西路188号9区
Section 9, No.188, Nansihuan Xilu, Beijing 100070, China



適合証明書

Certificate of Conformity

添付書類 Attachment 2

証明書番号(Certificate No.):
PSE13020655

発行日 Date of Issue :
2013 年 11 月 14 日

【 型式の区分 Type Classification 】

特定電気用品 :
(Name of Specified Electrical Appliance and Material)

温度ヒューズ
Thermal-link

| | |
|---------|---|
| 可溶体の主材料 | (1) ずず、鉛及びビスマスの合金のもの (2) ずず、鉛及びビスマスの合金以外の合金のもの (3) 合成樹脂又は有機化合物のもの (4) その他のもの |
| 容器 | (1) あるもの (2) ないもの |
| 端子 | (1) つめ形（丸形を含む。）のもの (2) 線付きのもの (3) その他のもの |
| 可溶体の形状 | (1) 板状のもの (2) 塊状のもの (3) その他もの |

中国品質認証センター
CHINA QUALITY
CERTIFICATION CENTRE

氏名
Name

発行者
Issued by



中国100070北京市南四环西路188号9区
Section 9, No.188, Nansihuan Xilu, Beijing 100070, China



適合証明書

Certificate of Conformity

証明書番号 Certificate No.

PSE13020654

申請者照会番号 Applicant Reference

CJP2013102001-0807

発行年月日 Date of Issue

2013年11月14日

申請者 Applicant

DONGGUAN BETTER ELECTRONIC TECHNOLOGY CO.,LTD
ROOM NO.102,103 OF 3RD BLOCK,114 OF 4TH BLOCK INNOVATIVE TECHNOLOGY PARK OF SONGSHAN LAKE HIGH-TECH INDUSTRY PARK DONGGUAN GUANGDONG CHINA

製造工場 Factor y

DONGGUAN BETTER ELECTRONIC TECHNOLOGY CO.,LTD
NANMEN VILLAGE, HENGKEN ADMINISTRATIVE ZONE, LIAOBU TOWN,DONGGUAN,GUANDONG. 523413,P.R.CHINA.

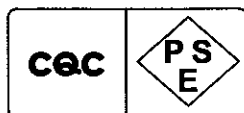

検査の方法 Standard for Certificate

・省令第2項技術基準：J60691(1122)

Article 2 of the Technical Requirements of the METI Ordinance

・施行規則別表第四

Appendix 4 of the Enforcement Regulations

特定電気用品名：

温度ヒューズ

Name of Specified Electrical Appliance and Material

Thermal-link

型式の区分：

(「添付書類」参照)

Type Classification

(Refer to Attachment)

モデル名：

BT1TF: 192°C

Model

製造事業者：

DONGGUAN BETTER ELECTRONIC TECHNOLOGY CO.,LTD

Manufacturer

証明書の有効期間：

2020年11月13日までに有効です。

Validity of Certificate

This certificate is expired on Nov. 13th, 2020

これは、上記申請者より申請のあった上記特定電気用品及び製造工場が、電気用品安全法第八条第一項に規定する技術基準及び同法第九条第二項の経済産業省令で定める基準に適合していることを証明するものです。

This is to certify that the above-mentioned Specified Electrical Appliances and Materials and the factory which the above-mentioned applicant applied for have been complied with the Technical Requirements stipulated by Article 8, Paragraph 1 of the Electrical Appliance and Material Safety Law and the requirements stipulated by the METI Ordinance specified in Article 9, paragraph 2 of the said law.

中国品質認証センター
CHINA QUALITY
CERTIFICATION CENTRE

氏名
Name

発行者
Issued by



中国100070北京市南四环西路188号9区

Section 9, No.188, Nansihuan Xilu, Beijing 100070, China

PJ 0003484



適合証明書

Certificate of Conformity

添付書類 Attachment 1

証明書番号(Certificate No.):
PSE13020654

発行日 Date of Issue :
2013年11月14日

【型式の区分 Type Classification】

特定電気用品 :
(Name of Specified Electrical Appliance and Material)

温度ヒューズ
Thermal-link

| 要素 | 区分 |
|---------|-----------------------|
| 定格電圧 | (1) 125V以下のもの |
| | (2) 125Vを超えるもの |
| 定格電流 | (1) 5A以下のもの |
| | (2) 5Aを超え15A以下のもの |
| | (3) 15Aを超え30A以下のもの |
| | (4) 30Aを超えるもの |
| 公称動作温度 | (1) 80℃以下のもの |
| | (2) 80℃を超え100℃以下のもの |
| | (3) 100℃を超え120℃以下のもの |
| | (4) 120℃を超え140℃以下のもの |
| | (5) 140℃を超え160℃以下のもの |
| | (6) 160℃を超え180℃以下のもの |
| | (7) 180℃を超え200℃以下のもの |
| | (8) 200℃を超え220℃以下のもの |
| | (9) 220℃を超え240℃以下のもの |
| | (10) 240℃を超え260℃以下のもの |
| | (11) 260℃を超え280℃以下のもの |
| | (12) 280℃を超え300℃以下のもの |
| | (13) 300℃を超えるもの |
| 可溶体への通電 | (1) あるもの |
| | (2) ないもの |

中国品質認証センター
CHINA QUALITY
CERTIFICATION CENTRE

氏名
Name

発行者
Issued by



中国100070北京市南四環西路188号9区
Section 9, No.188, Nansihuan Xilu, Beijing 100070, China



適合証明書

Certificate of Conformity

添付書類 Attachment 2

証明書番号(Certificate No.):
PSE13020654

発行日 Date of Issue :
2013 年 11 月 14 日

【 型式の区分 Type Classification 】

特定電気用品 :
(Name of Specified Electrical Appliance and Material)

温度ヒューズ
Thermal-link

| | |
|---------|---|
| 可溶体の主材料 | (1) ずず、鉛及びビスマスの合金のもの (2) ずず、鉛及びビスマスの合金以外の合金のもの (3) 合成樹脂又は有機化合物のもの (4) その他のもの |
| 容器 | (1) あるもの (2) ないもの |
| 端子 | (1) つめ形（丸形を含む。）のもの (2) 線付きのもの (3) その他のもの |
| 可溶体の形状 | (1) 板状のもの (2) 塊状のもの (3) その他のもの |

中国品質認証センター
CHINA QUALITY
CERTIFICATION CENTRE

氏名
Name

発行者
Issued by



中国100070北京市南四環西路188号9区
Section 9, No.188, Nansihuan Xilu, Beijing 100070, China



適合証明書

Certificate of Conformity

証明書番号 Certificate No.

PSE13020653

| | |
|---|---|
| 申請者照会番号 Applicant Reference | 発行年月日 Date of Issue |
| CJP2013102001-0806 | 2013年11月14日 |
| 申請者 Applicant | 製造工場 Factory |
| DONGGUAN BETTER ELECTRONIC TECHNOLOGY CO.,LTD | DONGGUAN BETTER ELECTRONIC TECHNOLOGY CO.,LTD |
| ROOM NO.102,103 OF 3RD BLOCK,114 OF 4TH BLOCK INNOVTIVE TECHNOLOGY PARK OF SONGSHAN LAKE HIGH-TECH INDUSTRY PARK DONGGUAN GUANGDONG CHINA | NANMEN VILLAGE, HENGKEN ADMINISTRATIVE ZONE, LIAOBU TOWN,DONGGUAN,GUANDONG. 523413,P.R.CHINA. |

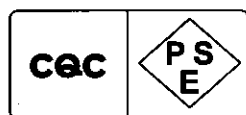

検査の方法 Standard for Certificate

- 省令第2項技術基準：J60691(H22)
Article 2 of the Technical Requirements of the METI Ordinance
- 施行規則別表第四
Appendix 4 of the Enforcement Regulations

| | |
|---|---|
| 特定電気用品名： Name of Specified Electrical Appliance and Material | 温度ヒューズ Thermal-link |
| 型式の区分： Type Classification | (「添付書類」参照) (Refer to Attachment) |
| モデル名： Model | BIT TF: 216°C |
| 製造事業者： Manufacturer | DONGGUAN BETTER ELECTRONIC TECHNOLOGY CO.,LTD |
| 証明書の有効期間： Validity of Certificate | 2020年11月13日までに有効です。 This certificate is expired on Nov. 13th, 2020 |

これは、上記申請者より申請のあった上記特定電気用品及び製造工場が、電気用品安全法第八条第一項に規定する技術基準及び同法第九条第二項の経済産業省令で定める基準に適合していることを証明するものです。

This is to certify that the above-mentioned Specified Electrical Appliances and Materials and the factory which the above-mentioned applicant applied for have been complied with the Technical Requirements stipulated by Article 8, Paragraph 1 of the Electrical Appliance and Material Safety Law and the requirements stipulated by the METI Ordinance specified in Article 9, paragraph 2 of the said law.

中国品質認証センター
CHINA QUALITY
CERTIFICATION CENTRE

氏名
Name

発行者
Issued by



中国100070北京市南四环西路188号9区
Section 9, No.188, Nansihuan Xilu, Beijing 100070, China

PJ 0003470



適合証明書

Certificate of Conformity

添付書類 Attachment 1

証明書番号(Certificate No.):
PSE13020653

発行日 Date of Issue:
2013年11月14日

【型式の区分 Type Classification】

特定電気用品:
(Name of Specified Electrical Appliance and Material)

温度ヒューズ
Thermal-link

| 要素 | 区分 |
|---------|-----------------------|
| 定格電圧 | (1) 125V以下のもの |
| | (2) 125Vを超えるもの |
| 定格電流 | (1) 5A以下のもの |
| | (2) 5Aを超え15A以下のもの |
| | (3) 15Aを超え30A以下のもの |
| | (4) 30Aを超えるもの |
| 公称動作温度 | (1) 80℃以下のもの |
| | (2) 80℃を超え100℃以下のもの |
| | (3) 100℃を超え120℃以下のもの |
| | (4) 120℃を超え140℃以下のもの |
| | (5) 140℃を超え160℃以下のもの |
| | (6) 160℃を超え180℃以下のもの |
| | (7) 180℃を超え200℃以下のもの |
| | (8) 200℃を超え220℃以下のもの |
| | (9) 220℃を超え240℃以下のもの |
| | (10) 240℃を超え260℃以下のもの |
| | (11) 260℃を超え280℃以下のもの |
| | (12) 280℃を超え300℃以下のもの |
| | (13) 300℃を超えるもの |
| 可溶体への通電 | (1) あるもの |
| | (2) ないもの |

中国品質認証センター
CHINA QUALITY
CERTIFICATION CENTRE

氏名
Name

発行者
Issued by



中国100070北京市南四环西路188号9区
Section 9, No.188, Nansihuan Xilu, Beijing 100070, China



適合証明書

Certificate of Conformity

添付書類 Attachment 2

証明書番号(Certificate No.):

PSE13020653

発行日 Date of Issue:

2013年11月14日

【 型式の区分 Type Classification 】

特定電気用品:

(Name of Specified Electrical Appliance and Material)

温度ヒューズ

Thermal-link

| | |
|---------|---|
| 可溶体の主材料 | (1) ずず、鉛及びビスマスの合金のもの (2) ずず、鉛及びビスマスの合金以外の合金のもの (3) 合成樹脂又は有機化合物のもの (4) その他のもの |
| 容器 | (1) あるもの (2) ないもの |
| 端子 | (1) つめ形(丸形を含む。)のもの (2) 線付きのもの (3) その他のもの |
| 可溶体の形状 | (1) 板状のもの (2) 塊状のもの (3) その他のもの |

中国品質認証センター
CHINA QUALITY
CERTIFICATION CENTRE

氏名
Name

発行者
Issued by



中国100070北京市南四环西路188号9区

Section 9, No.188, Nansihuan Xilu, Beijing 100070, China



適合証明書

Certificate of Conformity

証明書番号 Certificate No.

PSE13020652

申請者照会番号 Applicant Reference

CJP2013102001-0805

発行年月日 Date of Issue

2013年11月14日

申請者 Applicant

DONGGUAN BETTER ELECTRONIC TECHNOLOGY CO.,LTD

ROOM NO.102,103 OF 3RD BLOCK,114 OF 4TH BLOCK INNOVTIVE TECHNOLOGY PARK OF SONGSHAN LAKE HIGH-TECH INDUSTRY PARK DONGGUAN GUANGDONG CHINA

製造工場 Factory

DONGGUAN BETTER ELECTRONIC TECHNOLOGY CO.,LTD

NANMEN VILLAGE, HENGKEN ADMINISTRATIVE ZONE, LIAOBU TOWN,DONGGUAN,GUANDONG. 523413,P.R.CHINA.



検査の方法 Standard for Certificate

・省令第2項技術基準：J60691(H122)

Article 2 of the Technical Requirements of the METI Ordinance

・施行規則別表第四

Appendix 4 of the Enforcement Regulations

特定電気用品名：

Name of Specified Electrical Appliance and Material

型式の区分：

Type Classification

モデル名：

Model

製造事業者：

Manufacturer

証明書の有効期間：

Validity of Certificate

温度ヒューズ

Thermal-link

(「添付書類」参照)

(Refer to Attachment)

BTT Tf: 240°C

DONGGUAN BETTER ELECTRONIC TECHNOLOGY CO.,LTD

2020年11月13日までに有効です。

This certificate is expired on Nov. 13th, 2020

これは、上記申請者より申請のあった上記特定電気用品及び製造工場が、電気用品安全法第八条第一項に規定する技術基準及び同法第九条第二項の経済産業省令で定める基準に適合していることを証明するものです。

This is to certify that the above-mentioned Specified Electrical Appliances and Materials and the factory which the above-mentioned applicant applied for have been complied with the Technical Requirements stipulated by Article 8, Paragraph 1 of the Electrical Appliance and Material Safety Law and the requirements stipulated by the METI Ordinance specified in Article 9, paragraph 2 of the said law.

中国品質認証センター
CHINA QUALITY
CERTIFICATION CENTRE

氏名
Name

発行者
Issued by



中国100070北京市南四环西路188号9区

Section 9, No.188, Nansihuan Xilu, Beijing 100070, China

PJ 0003472



適合証明書

Certificate of Conformity

添付書類 Attachment 1

証明書番号(Certificate No.):
PSE13020652

発行日 Date of Issue :
2013年11月14日

【型式の区分 Type Classification】

特定電気用品 :
(Name of Specified Electrical Appliance and Material)

温度ヒューズ
Thermal-link

| 要素 | 区分 |
|---------|-----------------------|
| 定格電圧 | (1) 125V以下のもの |
| | (2) 125Vを超えるもの |
| 定格電流 | (1) 5A以下のもの |
| | (2) 5Aを超え15A以下のもの |
| | (3) 15Aを超え30A以下のもの |
| | (4) 30Aを超えるもの |
| 公称動作温度 | (1) 80℃以下のもの |
| | (2) 80℃を超え100℃以下のもの |
| | (3) 100℃を超え120℃以下のもの |
| | (4) 120℃を超え140℃以下のもの |
| | (5) 140℃を超え160℃以下のもの |
| | (6) 160℃を超え180℃以下のもの |
| | (7) 180℃を超え200℃以下のもの |
| | (8) 200℃を超え220℃以下のもの |
| | (9) 220℃を超え240℃以下のもの |
| | (10) 240℃を超え260℃以下のもの |
| | (11) 260℃を超え280℃以下のもの |
| | (12) 280℃を超え300℃以下のもの |
| | (13) 300℃を超えるもの |
| 可溶体への通電 | (1) あるもの |
| | (2) ないもの |

中国品質認証センター
CHINA QUALITY
CERTIFICATION CENTRE

氏名
Name

発行者
Issued by



中国100070北京市南四環西路188号9区
Section 9, No.188, Nansihuan Xilu, Beijing 100070, China



適合証明書

Certificate of Conformity

添付書類 Attachment 2

証明書番号(Certificate No.):
PSE13020652

発行日 Date of Issue :
2013 年 11 月 14 日

【 型式の区分 Type Classification 】

特定電気用品 :
(Name of Specified Electrical Appliance and Material)

温度ヒューズ
Thermal-link

| | |
|---------|---|
| 可溶体の主材料 | (1) ずず、鉛及びビスマスの合金のもの (2) ずず、鉛及びビスマスの合金以外の合金のもの (3) 合成樹脂又は有機化合物のもの (4) その他のもの |
| 容器 | (1) あるもの (2) ないもの |
| 端子 | (1) つめ形（丸形を含む。）のもの (2) 線付きのもの (3) その他のもの |
| 可溶体の形状 | (1) 板状のもの (2) 塊状のもの (3) その他のもの |

中国品質認証センター
CHINA QUALITY
CERTIFICATION CENTRE

氏名
Name

発行者
Issued by



中国100070北京市南四环西路188号9区
Section 9, No.188, Nansihuan Xilu, Beijing 100070, China

X-ON Electronics

Largest Supplier of Electrical and Electronic Components

Click to view similar products for [Thermal Cutoffs](#) category:

Click to view products by [Better manufacturer](#):

Other Similar products are found below :

[RTP200HR010SA](#) [MHP-TAT18-9-85N](#) [MHP-TAT18-9-77N](#) [MHP-TAT18-9-72N](#) [MHP-TAT18-9-82N](#) [MHP-TAT18-9-90N](#) [CR-135-EWT](#)
[AA72A10](#) [AA85A10](#) [AA77A10](#) [MHP-TAM15-9-90](#) [SA85SB0](#) [AA82A10](#) [MHP-TAM15-9-72](#) [SA77SB0](#) [SA72SB0](#) [MHP-TAM6-9-85](#)
[MHP-TAM15-9-85](#) [9K9.9700-080/5JSB/060C/QTG](#) [AA72AB0](#) [AC72ABD](#) [AC77ABD](#) [AC82ABD](#) [AC85ABD](#) [AC90ABD](#) [CB72A1B](#)
[CB72ABB](#) [CB77A1B](#) [CB77ABB](#) [CB82A1B](#) [CB85A1B](#) [CB85ABB](#) [HC72AY-1](#) [HC77AY-1](#) [HC82AY-1](#) [HC85AY-1](#) [KCA72AB0](#)
[KCA85AB0](#) [LC82AY-1](#) [LC85AY-1](#) [NR77AB0](#) [NR77CB0](#) [NR82CB0](#) [NR85AB0](#) [NR85CB0](#) [P-TCO-N350/12-2](#) [P-TCO-N400/12-2](#) [P-TCO-N450/12-2](#) [P-TCO-U350/12-2](#) [P-TCO-U400/12-2](#)