

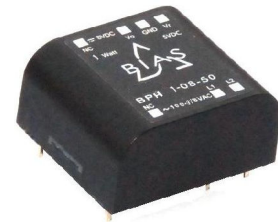

BIAS 1 Watt Power Supply BPH 1 Series Data Sheet

Single (Vo) or Dual (Vo & Vr) output
BPH 1-08-00, -08-33, -08-50
BPH 1-14-00, -14-33, -14-50



Actual Size

The BPH Power Supply Module is specifically design to comply with Canadian power distribution where operation from 347VAC mains is required. This low-cost supply provides up to one watt of output power at 8 or 14 VDC (Vo) and an optional 3.3 or 5 VDC (Vr) output for microprocessors, logic, timing circuits, transceivers, sensors or other control functions. A patented design incorporating a custom integrated circuit into a small package (0.55 in³ [9.0 cm³]) the BIAS Module provides an immediate “drop-in” solution, requiring no additional external components.

Operating Specifications

(@120VAC / 60 Hz / 25°C unless otherwise specified)

Electrical	
Input Voltage Range	100 - 375 VAC (50/60Hz)
Input Surge Withstand	420V, < 30 sec
Output Power (Pmax)	1.0 W min. (60Hz) 0.83 W min. (50Hz)
Efficiency	70% nom.
Output Vo (Peak)	8 or 14 VDC nom. +/- 5%
Line / Load Regulation Vo (Peak)	+/- 1% Po < Pmax
Temperature Regulation Vo (Peak)	+/- 2% Po < Pmax
Ripple Vo (@120 Hz) (@ 100 kHz)	1.00 V p:p 0.25 V p:p
Output Vr, 3.3 volt (+/- 5%)	For Vo = 8V, Ir out 53mA max, Io+Ir ≤ 125mA* For Vo = 14V, Ir out 23mA max, Io+Ir ≤ 71mA*
Output Vr, 5.0 volt (+/- 5%)	For Vo = 8V, Ir out 83mA max, Io+Ir ≤ 125mA* For Vo = 14V, Ir out 28mA max, Io+Ir ≤ 71mA*
No-load Consumption	30 mW typical @ Vin=120 VAC
Isolation	3000 VAC (meets UL / CSA & EN Product Safety)
Earth Leakage @ 120 VAC	< 10 uA
Short Circuit Protection	Continuous, Pin ≤ 0.6 w @ Vin = 120 VAC
Reliability @ 25° C, MIL HDBK-217F	> 500 Khr MTBF
Thermal	
Operating Temperature	-30 to +70° C
Operating Relative Humidity	0 – 95%, non-condensing
Storage Temperature	-40 to +105° C
Mechanical	
Package Size (L x W x H)	1.10 x 0.92 x 0.55 inches [27.94 x 23.24 x 13.97 mm]
Safety	
Safety Compliance	UL/EN 60950-1 2 nd Edition (CB Report Available)
EMI Emissions	EN 55022, Class B, FCC Part 15, Class B

Features

- Complies with CSA CAN3-C235-83
- Universal Input (100-375 VAC, 50/60Hz)
- Small Size—0.55in³ [9.0cm³]
- Low no-load input power <30mW
- Constant power mode, not current limit
- 3000 VAC Isolation
- Up to 75% efficiency
- EN 55022, Class B; FCC Part 15, Class B
- Meets UL/CSA and EN Product Safety (ITE)

Bias Power AC/DC power supplies are designed to be applied in two major categories of applications...

Auxiliary, where the Bias supply is one of two or more supplies and provides power for standby, housekeeping, biasing or other requirements. Generally, these supply 3.3V or 5.0V requirements from the Vr output. In some cases a small amount of Vo power is used.

Second is as a main or utility supply where Bias is the only supply and provides all power necessary for the product or system. Both Vr and Vo supplies are often utilized for optimum system performance.

The characteristics of the Vo and Vr outputs are different and each has application-specific benefits which can provide high value to the system designer.

Vo is a voltage-regulated output which has a constant power mode instead of a conventional current limit. This output is best suited to drive mechanical relays, solenoids, SSRs, capacitive loads, indicating lights, LEDs and as a source for isolated DC utility power which may be used directly or post-regulated with either a linear regulator or a DC/DC converter. Vo is self protecting, cannot be overloaded and can be shorted indefinitely. The graceful transition from voltage regulation to constant power along with the wide range of product ratings, allows the designer to select a supply tightly matched to the design load. There is no need to oversize a Bias Power supply. Unlike design-your-own, or partially complete modules where significant design margin is required, to stay far away from current limit, Bias's constant power alternative requires no such over-spec'ing.

Vr is also a voltage-regulated output and is thermally protected from overload. It has very low output ripple capable of driving microprocessors, logic, transceiver, sensors and other elements which require a low-noise, tightly-regulated supply. In addition, Vr is supplied internally by Vo. This means that any capacitance added to Vo can increase the hold-up time of Vr as well.

*Note: maximum currents specified for constant voltage range only. See V-I curve on page 2 for Vo in constant power range.



BIAS 1 Watt Power Supply

BPH 1 Series Data Sheet

Single (Vo) or Dual (Vo & Vr) output

BPH 1-08-00, -08-33, -08-50

BPH 1-14-00, -14-33, -14-50

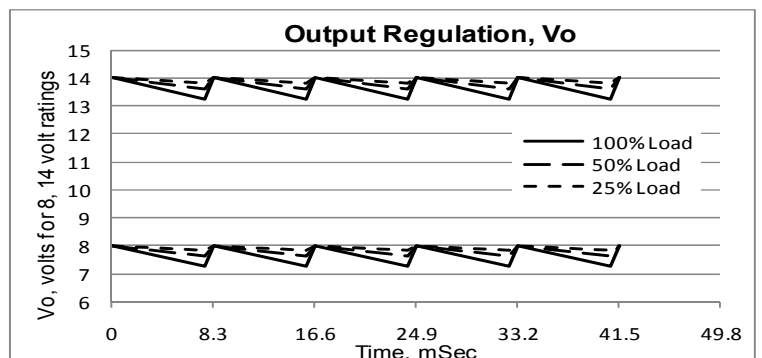
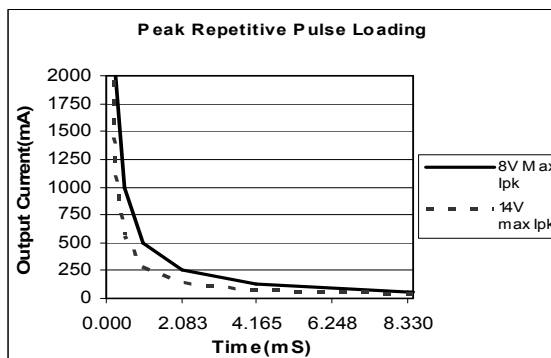
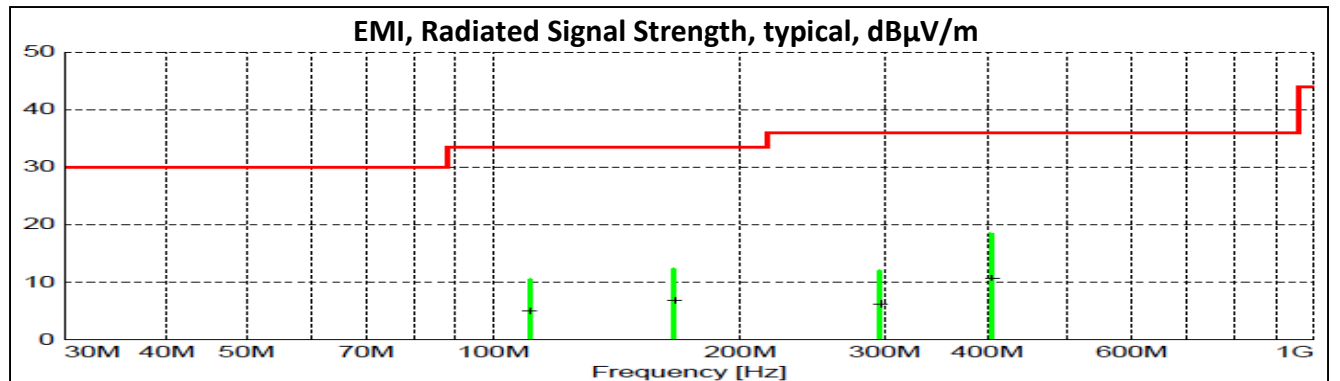
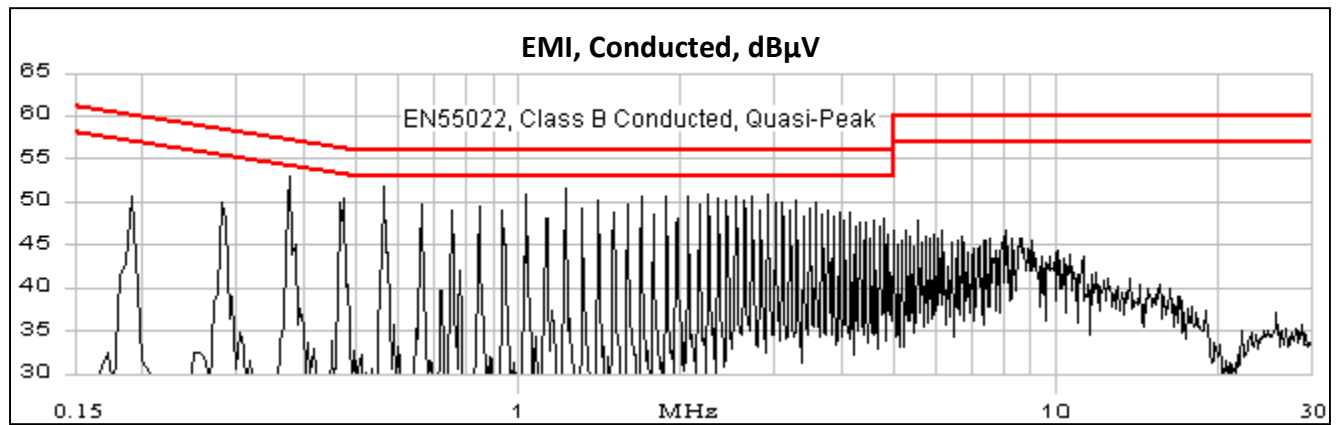
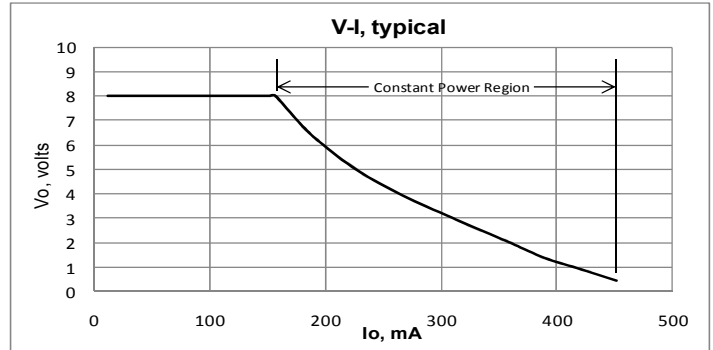
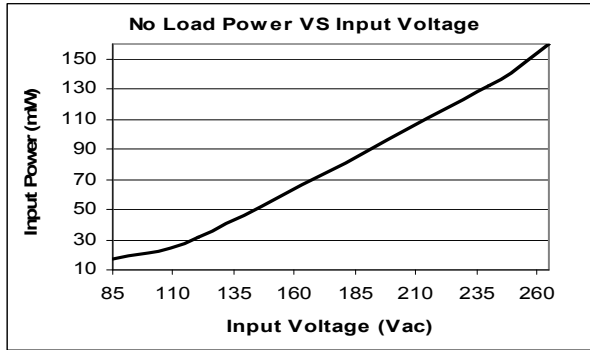



BIAS 1 Watt Power Supply

BPH 1 Series Data Sheet

Single (Vo) or Dual (Vo & Vr) output

BPH 1-08-00, -08-33, -08-50

BPH 1-14-00, -14-33, -14-50

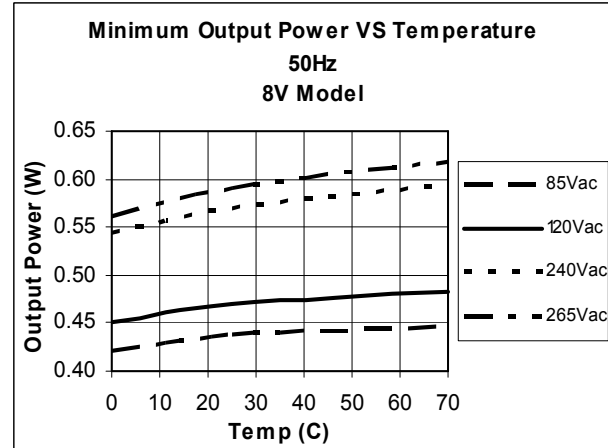
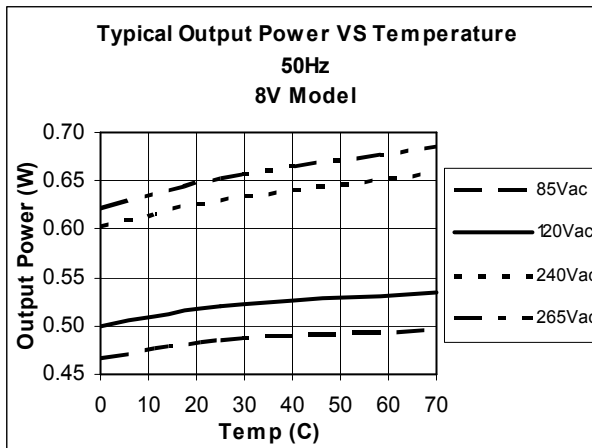
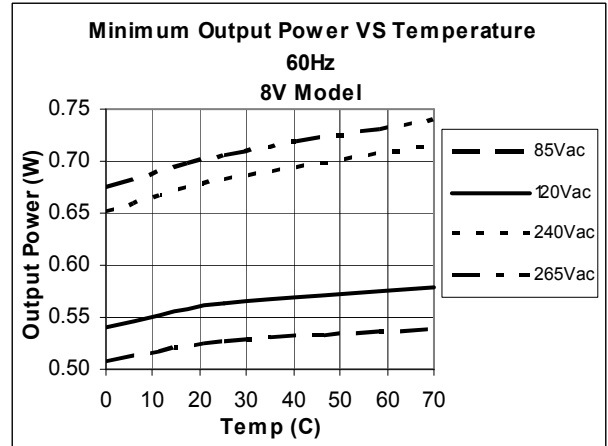
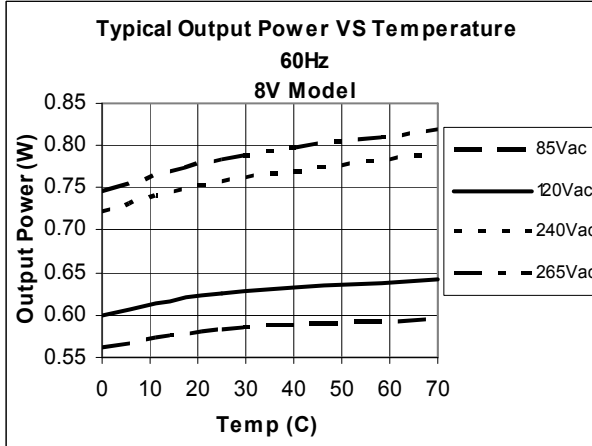



BIAS 1 Watt Power Supply

BPH 1 Series Data Sheet

Single (Vo) or Dual (Vo & Vr) output

BPH 1-08-00, -08-33, -08-50

BPH 1-14-00, -14-33, -14-50

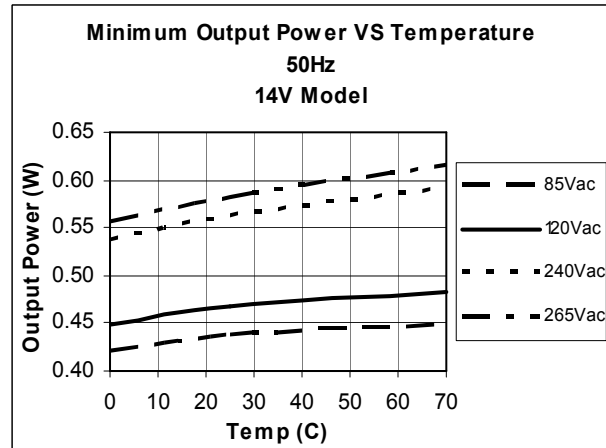
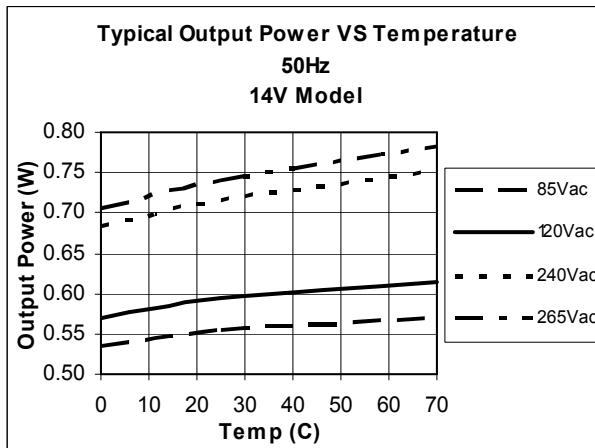
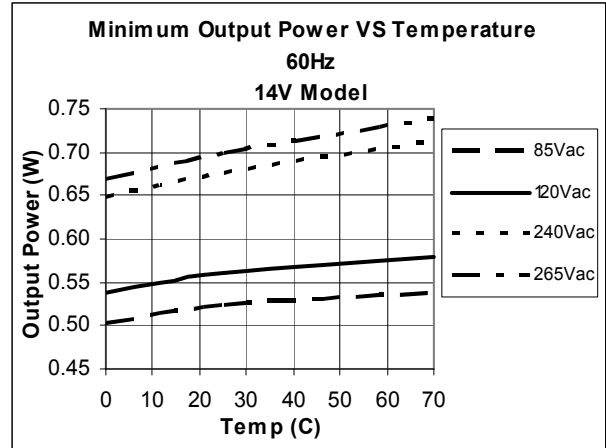
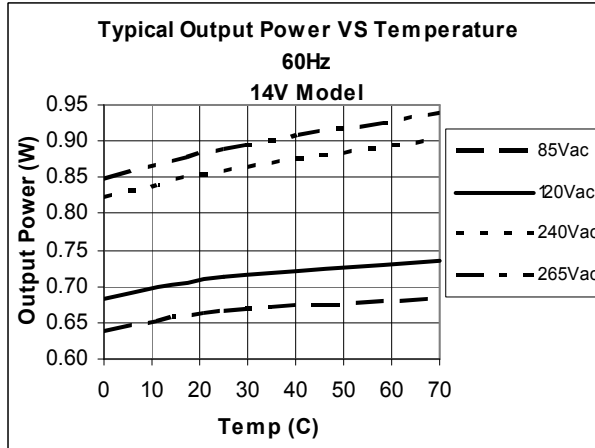



BIAS 1 Watt Power Supply

BPH 1 Series Data Sheet

Single (Vo) or Dual (Vo & Vr) output

BPH 1-08-00, -08-33, -08-50

BPH 1-14-00, -14-33, -14-50



Part Number Designation

Part Number	Output Configuration	Vo	Vr
BPH 1-08-00	Single output	8 VDC	N/A
BPH 1-14-00	Single output	14 VDC	N/A
BPH 1-08-33	Dual Output	8 VDC	3.3 VDC
BPH 1-08-50	Dual Output	8 VDC	5 VDC
BPH 1-14-33	Dual Output	14 VDC	3.3 VDC
BPH 1-14-50	Dual Output	14 VDC	5 VDC

For custom configurations, contact BIAS Power.

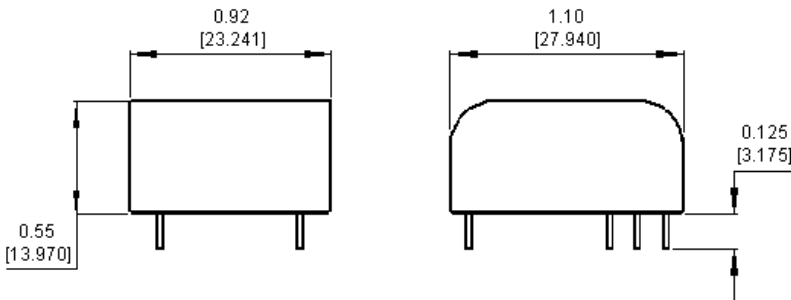

PIN	DESCRIPTION
L1	Input High
L2	Input Low
N/C	No Connection
Vo	Output
GND	Ground
Vr	Vr Output
N/C	No Connection

Recommended Land Pattern, top view

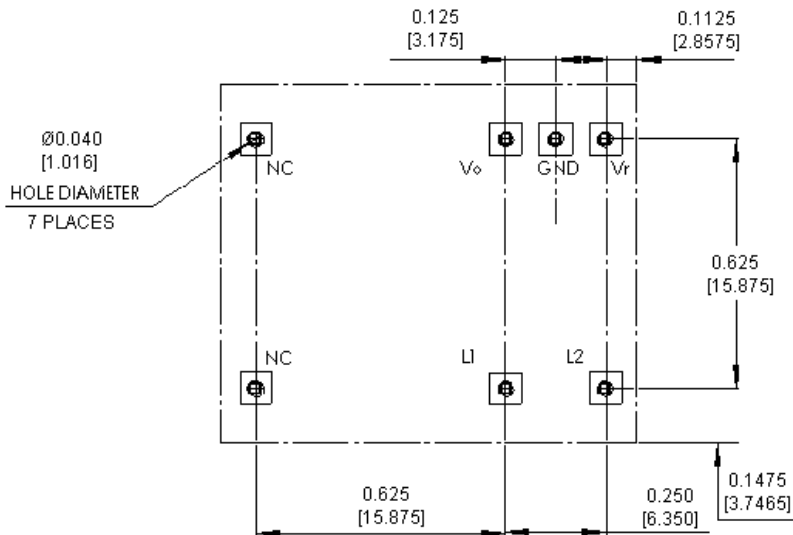

Isolation, Bottom View

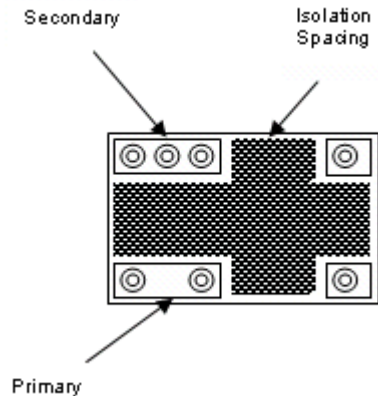

- NOTES**
1. Pins 0.031" [0.787 mm] round
 2. Pins extend 0.125" [3.175 mm] below stand-offs

X-ON Electronics

Largest Supplier of Electrical and Electronic Components

Click to view similar products for [AC/DC Power Modules](#) category:

Click to view products by [BIAS Power](#) manufacturer:

Other Similar products are found below :

[VI-HAM-CM](#) [ERP-350-12](#) [KPSB25-12-J](#) [KPSB25-15-J](#) [KPSB25-24-J](#) [KPSB25-36-J](#) [KPSB25-5-J](#) [KPSB6-12-J](#) [KPSB6-5-J](#) [TMPS 03-112](#)
[TMPS 03-115](#) [TMPS 03-124](#) [IRM-03-9S](#) [LFWLT300-CK](#) [TMPS 03-109](#) [TPP 40-112](#) [TPP 65-105](#) [TPP 65-112](#) [VOF-275-48](#) [RAC04-12DC/277-E](#) [RAC04-12SC/277-E](#) [RAC04-05DC/277-E](#) [RAC04-0512DC/277-E](#) [PFE700SA-48/T](#) [MFM-15-12](#) [MFM-15-5](#) [MFM-20-12](#)
[MFM-20-5](#) [MPM-05-12](#) [MPM-05-24](#) [MPM-05-5](#) [MPM-10-12](#) [MPM-10-24](#) [MPM-15-24](#) [MPM-15-5](#) [MPM-20-12](#) [MPM-20-24](#) [MPM-20-5](#)
[MPM-30-12](#) [MPM-30-24](#) [MPM-30-5](#) [RAC01-05SGA](#) [RAC01-05SGB](#) [RAC01-12SGB](#) [RAC02-05SGA](#) [RAC02-05SGB](#) [RAC02-12SGA](#)
[RAC03-05SGA](#) [RAC03-05SGB](#) [RAC03-12SGA](#)