

## Subminiatursteckverbinder Serie 710 Subminiature connectors series 710

Bezeichnung  
Description

Flanschstecker  
Male socket

Flanschdose  
Female socket

Abbildung  
Figure



Maßzeichnung  
Drawing

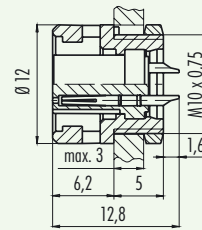
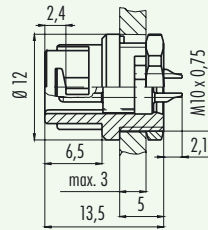

Bestell-Nr.  
Ordering-No.

Polzahl Contacts	Bestell-Nr. Ordering-No.
2	09-0973-00-02
3	09-0977-00-03
4	09-0981-00-04
5	09-0997-00-05
7	09-9477-00-07
8	09-9481-00-08

Polzahl Contacts	Bestell-Nr. Ordering-No.
2	09-0974-00-02
3	09-0978-00-03
4	09-0982-00-04
5	09-0998-00-05
7	09-9478-00-07
8	09-9482-00-08

### Technische Daten Specifications

	2	3	4	5	7	8	
Polzahl	2	3	4	5	7	8	Number of contacts
Steckverbinder Verriegelung	Bajonett/bayonet						Connector locking system
Anschlussart	löten/solder						Termination
Anschlussquerschnitt	max. 0,25 mm <sup>2</sup> (max. AWG 24)			max. 0,14 mm <sup>2</sup> (max. AWG 26)			Wire gauge
Kabeldurchlass	-						Cable outlet
Schutzart	IP40						Degree of protection
Mechanische Lebensdauer	> 500 Steckzyklen/>5100 mating cycles						Mechanical operation
Obere Grenztemperatur	+ 85 °C						Upper temperature
Untere Grenztemperatur	- 40 °C						Lower temperature
Bemessungsspannung	125 V						Rated voltage
Bemessungsstoßspannung	1500 V						Rated impulse voltage
Verschmutzungsgrad	I						Pollution degree
Überspannungskategorie	II						Overvoltage categorie
Isolierstoffgruppe	III						Material group
Bemessungsstrom (40°C)	4 A		3 A		1 A		Rated current (40 °C)
Durchgangswiderstand	≤ 3 mΩ						Contact resistance
Material Kontakt	Stift/pin CuZn (Messing/brass), Buchse/socket CuSn (Bronze/bronze)						Material of contact
Kontaktoberfläche	Au (Gold/gold)						Contact plating
Material Kontaktkörper	PA (UL 94 V-0)						Material of contact body
Material Gehäuse	PA (UL 94 HB)						Material of housing



ü

TI

SI P40

SI P67

Bajonett

PP P67

M9 P40

M9 P67

SI P67

Bajonett

PP P67

M16 P40

M16 P67

M23

Bajonett

M25

RD24

RD30

M5

M8

M12-A

VL

M12-PP

Verteiler

M12-B

M12-D

M12-US

M18

7/8"

BF-A

BF-B

BF-C

R



# Bajonett

## Subminiatursteckverbinder Serie 710 Subminiature connectors series 710

Einzelteildarstellung  
Component part drawing

Kabelstecker  
Male cable connectors

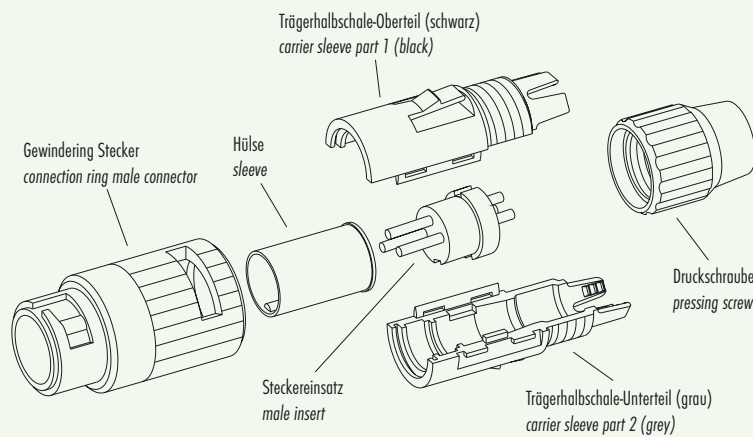

Kabeldose  
Female cable connectors

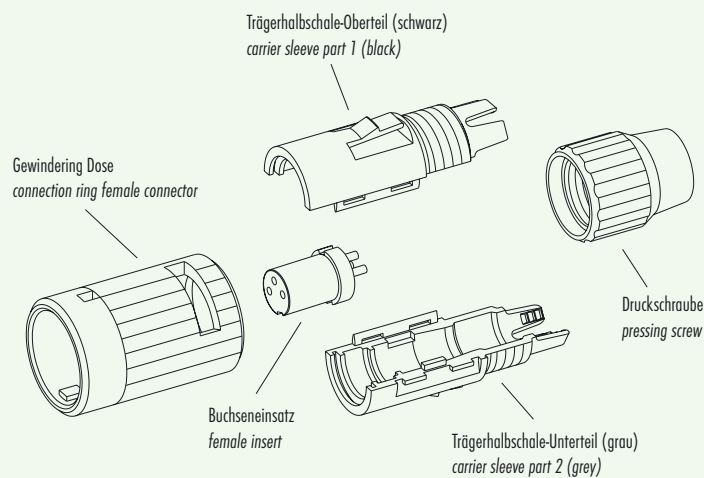

## Subminiatursteckverbinder Serie 710 Subminiature connectors series 710

## Zubehör Accessories

Abbildung  
Figure

Montageschlüssel  
Mounting spanner

Maßzeichnung  
Drawing

Bestell-Nr.  
Ordering-No.

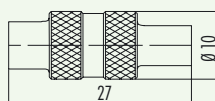

01-5059-001



## Subminiatursteckverbinder Serie 710 Subminiature connectors series 710

Polbilder  
Contact arrangements

Stifteinsatz (Steckseite)  
Male insert (mating side)

Buchseinsatz (Steckseite)  
Female insert (mating side)

2 pol  
2 contacts

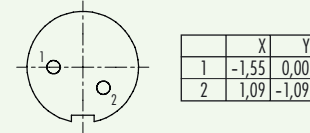
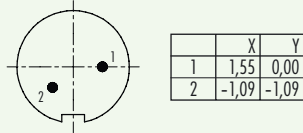

3 pol  
3 contacts

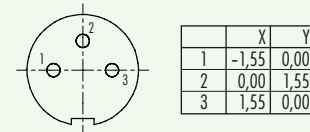
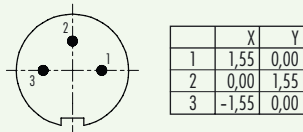

4 pol  
4 contacts

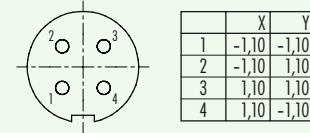
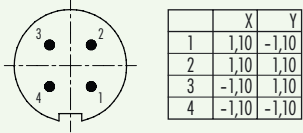

5 pol  
5 contacts

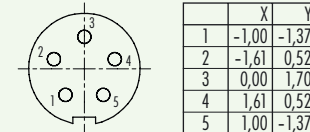
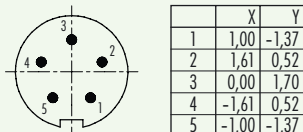

7 pol  
7 contacts

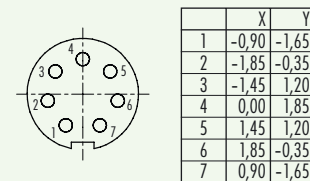
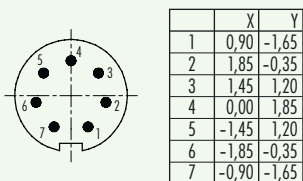

8 pol  
8 contacts

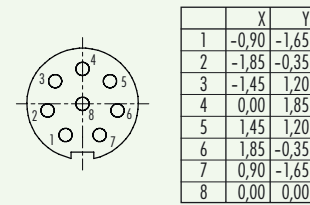
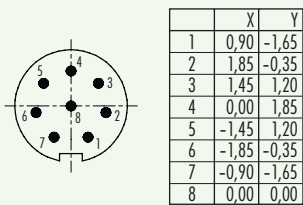

Montageausschnitt  
Panel cut out

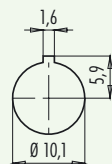

## X-ON Electronics

Largest Supplier of Electrical and Electronic Components

*Click to view similar products for [binder manufacturer](#):*

Other Similar products are found below :

[16-8085-001](#) [16-8100-000](#) [16-8090-000](#) [16-8093-000](#) [09 0330 00 12](#) [09 0153 70 08](#) [09 0305 00 03](#) [09 0337 00 16](#) [09 0477 00 07](#) [09 9478 00 07](#) [66-0004-001](#) [99-9125-60-08](#) [99-9106-60-03](#) [99 0612 00 04](#) [99 0079 100 04](#) [79-3108-52-04](#) [79-3110-52-04](#) [66-0003-001](#) [99-3782-200-08](#) [61-0903-139](#) [09 5283 00 03](#) [09-0316-702-05](#) [66-0005-000](#) [02-0055-001](#) [09-5288-00-08](#) [09-0104-300-02](#) [09-0110-25-04](#) [09-0112-782-04](#) [09-0173-300-08](#) [09-0312-290-04](#) [99-4218-300-07](#) [09-3442-92-05](#) [99-0437-186-05](#) [99-0218-210-07](#) [43-1706-000-04](#) [08-2809-000-000](#) [99-9205-050-03](#) [99-0201-00-07](#) [09-0312-09-04](#) [99-0610-02-04](#) [09-0319-80-05](#) [99-9206-050-03](#) [09-0073-20-02](#) [09-0081-20-04](#) [99-0143-12-06](#) [99-2009-210-04](#) [09-4912-080-04](#) [99-5681-15-07](#) [09-0062-00-05](#) [09-0053-80-14](#)