

Product description	M5 male panel mount connector, Contacts: 4, not shielded, single wires, IP67
Area	M5 series 707
Order number	09 3111 00 04

Illustration

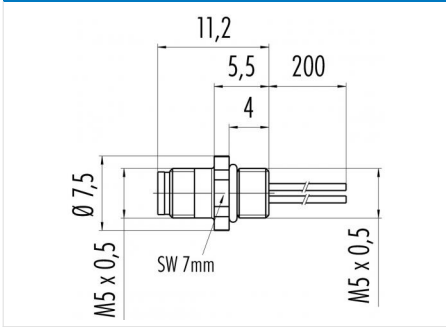

Scale drawing



Contact arrangement (Plug-in side)

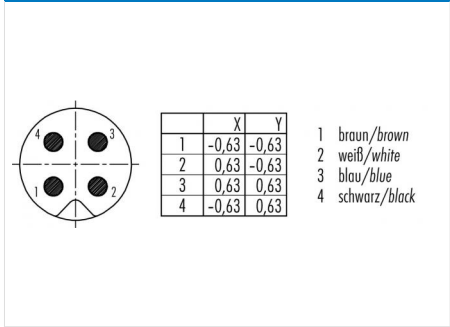

Technical data

General values

Connector design	male panel mount connector
Connector locking system	screw
Termination	single wires
Wire gauge (mm)	0.14 mm ²
Wire gauge (AWG)	26
Upper limit temperature	80 °C
Lower limit temperature	-25 °C
Customs tariff number	85369010

Electrical values

Rated current (40 °C)	1 A
Rated voltage	60 V
Rated impulse voltage	800 V
Pollution degree	3
Overvoltage category	II
Insulating material group	I
Insulation resistance	> 10 ⁸ Ω
EMC compliance	not shielded
Degree of protection	IP67
Mechanical operation	> 100 Mating cycles

Material

Contact material	CuZn (brass)
Contact plating	Au (gold)
Contact body material	PA
REACH SVHC	CAS 7439-92-1 (Lead)

Product description	M5 male panel mount connector, Contacts: 4, not shielded, single wires, IP67
Area	M5 series 707
Order number	09 3111 00 04

Security notices

The connectors are designed for use in plant, control system and electrical equipment. The end user is responsible for checking whether the connectors are suitable for use in other applications. Connectors with degree of protection IP 67 and IP 68 are not suitable for use under water. When used outdoors, the connectors must be separately protected against corrosion. For further information about IP degrees of protection refer to 'Technical support' in the Download Centre.

X-ON Electronics

Largest Supplier of Electrical and Electronic Components

Click to view similar products for [Circular MIL Spec Connector](#) category:

Click to view products by [Binder manufacturer](#):

Other Similar products are found below :

[89075GULPR](#) [0025-262-542](#) [0025-263-3014](#) [0025-264-3014](#) [0031-065-002](#) [0031-071-002](#) [0134-201-1007](#) [0134-202-0800](#) [0134-202-1200](#)
[0134-202-2407](#) [0134-207-1206](#) [0134-207-1800](#) [0134-207-2207](#) [0134-213-0806](#) [0134-213-1007](#) [0134-213-1009](#) [0134-213-1200](#) [0134-213-1208](#) [0134-213-1800](#) [0134-213-2209](#) [0025-258-000](#) [0025-259-542](#) [0031-066-002](#) [0031-068-002](#) [0031-069-002](#) [0031-070-002](#) [0031-072-002](#)
[015-9516-002](#) [020313-0043](#) [020340-0009](#) [020418-0036](#) [020419-0080](#) [020419-0120](#) [020420-0108](#) [60-042022-07P](#) [60-042022-23P](#) [60-042217-10P](#) [60-042217-11P](#) [60-042722-19P](#) [0104-201-2402](#) [0114-201-1278](#) [024251-0015](#) [602GB06EG1832SN](#) [0134-201-1207](#) [0134-201-1410](#) [0134-201-1806](#) [0134-201-2006](#) [0134-201-2007](#) [0134-201-2010](#) [0134-201-2200](#)