



Ü

TI

SI IP40

SI IP67

Baionett

PP IP67

M9 IP40

M9 IP67

SI IP67

Baionett

PP IP67

M16 IP40

M16 IP67

M23

Baionett

M25

RD24

RD30

M5

M8

M12-A

VL

M12 PP

Verteiler

M12-B

M12-D

M12-US

M18

7/8"

BFA

BFB

BFC

R

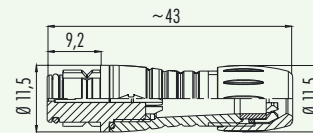
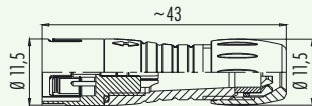
**binder****Snap-in IP67****Subminiatursteckverbinder Serie 620**  
**Subminiature connectors series 620****Bezeichnung**  
*Description***Kabelstecker**  
*Male cable connector***Kabeldose**  
*Female cable connector***Abbildung**  
*Figure***Maßzeichnung**  
*Drawing***Bestell-Nr.**  
*Ordering-No.*

Polzahl Contacts	Bestell-Nr. Ordering-No.
3	99-9205-00-03
4	99-9209-00-04
5	99-9213-00-05
8	99-9225-00-08

Polzahl Contacts	Bestell-Nr. Ordering-No.
3	99-9206-00-03
4	99-9210-00-04
5	99-9214-00-05
8	99-9226-00-08

**Technische Daten**  
*Specifications*

Polzahl	3	4	5	8	
Steckverbinder Verriegelung	schnapp/snap-in				Number of contacts
Anschlussart	löten/solder				Connector locking system
Anschlussquerschnitt	max. 0,25 mm <sup>2</sup> (max. AWG 24)				Termination
Kabeldurchlass	3-5 mm				Wire gauge
Schutzart	IP67				Cable outlet
Mechanische Lebensdauer	> 500 Steckzyklen/> 500 mating cycles				Degree of protection
Obere Grenztemperatur	+ 85 °C				Mechanical operation
Untere Grenztemperatur	- 25 °C				Upper temperature
Bemessungsspannung	125 V			63 V	Lower temperature
Bemessungsstoßspannung	1500 V			800 V	Rated voltage
Verschmutzungsgrad	2				Rated impulse voltage
Überspannungskategorie	II				Pollution degree
Isolierstoffgruppe	II				Overvoltage categorie
Bemessungsstrom (40 °C)	3 A	2,5 A	2 A	1 A	Material group
Durchgangswiderstand	≤ 3 mΩ				Rated current (40 °C)
Material Kontakt	Stift/pin CuZn (Messing/brass), Buchse/socket CuSn (Bronze/bronze)				Contact resistance
Kontaktoberfläche	Au (Gold/gold)				Material of contact
Material Kontaktkörper	PA (UL 94 V-0)				Contact plating
Material Gehäuse	PA (UL 94 V-0)				Material of contact body
					Material of housing

**3** Snap-in IP67

**Subminiatursteckverbinder Serie 620**  
**Subminiature connectors series 620**

Einzelteildarstellung  
 Component part drawing

Kabelsteckverbinder  
 Cable connectors

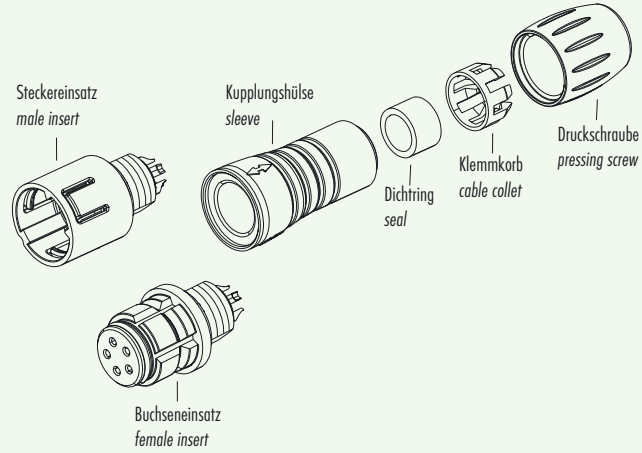

Flanschsteckverbinder  
 Socket connectors

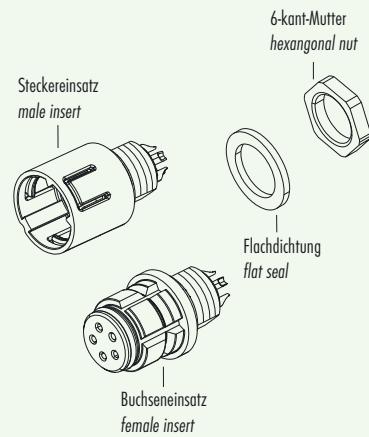

Adapter  
 Adapter

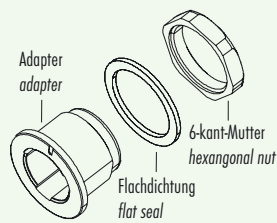

Adapter, von vorn verschraubt  
 Adapter, front fastened

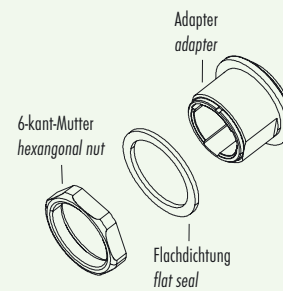

- ü
- TI
- SI IP40
- SI IP67**
- Bayonett
- PP IP67
- M9 IP40
- M9 IP67
- M9 IP67
- SI IP67
- Bayonett
- PP IP67
- M16 IP40
- M16 IP67
- M16 IP67
- M23
- Bayonett
- M25
- RD24
- RD30
- M5
- M8
- M12-A
- VL
- M12 PP
- Verteiler
- M12-B
- M12-D
- M12-US
- M18
- 7/8"
- BFA
- BF-B
- BF-C
- R



Ü

TI

SI IP40

SI IP67

Bajonet

PP IP67

M9 IP40

M9 IP67

SI IP67

Bajonet

PP IP67

M16 IP40

M16 IP67

M23

Bajonet

M25

RD24

RD30

M5

M8

M12-A

VL

M12-PP

Verteiler

M12-B

M12-D

M12-US

M18

7/8"

BF-A

BF-B

BF-C

R



# Snap-in IP67

## Subminiatursteckverbinder Serie 620 Subminiature connectors series 620

Polbilder  
Contact arrangements

Stifteinsatz (Steckseite)  
Male insert (mating side)

Buchseinsatz (Steckseite)  
Female insert (mating side)

3 pol  
3 contacts

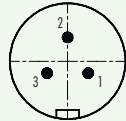

	X	Y
1	1,82	-1,05
2	0,00	2,10
3	-1,82	-1,05

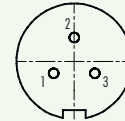

	X	Y
1	-1,82	-1,05
2	0,00	2,10
3	1,82	-1,05

4 pol  
4 contacts

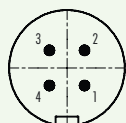

	X	Y
1	1,55	-1,55
2	1,55	1,55
3	-1,55	1,55
4	-1,55	-1,55

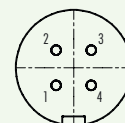

	X	Y
1	-1,55	-1,55
2	-1,55	1,55
3	1,55	1,55
4	1,55	-1,55

5 pol  
5 contacts



	X	Y
1	1,23	-1,70
2	2,00	0,65
3	0,00	2,10
4	-2,00	0,65
5	-1,23	-1,70



	X	Y
1	-1,23	-1,70
2	-2,00	0,65
3	0,00	2,10
4	2,00	0,65
5	1,23	-1,70

8 pol  
8 contacts

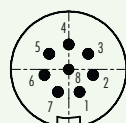

	X	Y
1	0,96	-1,98
2	2,15	-0,49
3	1,72	1,37
4	0,00	2,20
5	-1,72	1,37
6	-2,15	-0,49
7	-0,96	-1,98
8	0,00	0,00

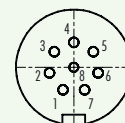

	X	Y
1	-0,96	-1,98
2	-2,15	-0,49
3	-1,72	1,37
4	0,00	2,20
5	1,72	1,37
6	2,15	-0,49
7	0,96	-1,98
8	0,00	0,00

Montageausschnitt  
Panel cut out

Flanschsteckverbinder  
Socket connectors

Adapter  
Adapter

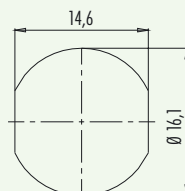
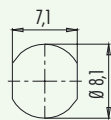

## X-ON Electronics

Largest Supplier of Electrical and Electronic Components

*Click to view similar products for [binder manufacturer](#):*

Other Similar products are found below :

[16-8085-001](#) [16-8100-000](#) [16-8090-000](#) [16-8093-000](#) [09 0330 00 12](#) [09 0153 70 08](#) [09 0305 00 03](#) [09 0337 00 16](#) [09 0477 00 07](#) [09 9478 00 07](#) [66-0004-001](#) [99-9125-60-08](#) [99-9106-60-03](#) [99 0079 100 04](#) [79-3108-52-04](#) [79-3110-52-04](#) [66-0003-001](#) [99-3782-200-08](#) [61-0903-139 09 5283 00 03](#) [09-0316-702-05](#) [66-0005-000](#) [02-0055-001](#) [09-5288-00-08](#) [09-0104-300-02](#) [09-0110-25-04](#) [09-0112-782-04](#) [09-0173-300-08](#) [09-0312-290-04](#) [99-4218-300-07](#) [09-3442-92-05](#) [99-0437-186-05](#) [99-0218-210-07](#) [43-1706-000-04](#) [08-2809-000-000](#) [99-9205-050-03](#) [99-0201-00-07](#) [09-0312-09-04](#) [99-0610-02-04](#) [09-0319-80-05](#) [99-9206-050-03](#) [09-0073-20-02](#) [09-0081-20-04](#) [09-0322-92-06](#) [99-2026-20-07](#) [43-1714-133-03](#) [99-0143-12-06](#) [99-0142-12-05](#) [99-3400-400-03](#) [99-2009-210-04](#)