

Subminiatursteckverbinder Serie 620 Subminiature connectors series 620

Bezeichnung
Description

Flanschstecker
Male socket

Flanschdose
Female socket

Abbildung
Figure



Maßzeichnung
Drawing

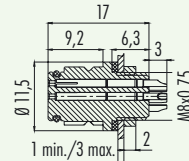
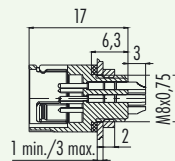

Bestell-Nr.
Ordering-No.

Polzahl Contacts	Bestell-Nr. Ordering-No.	Polzahl Contacts	Bestell-Nr. Ordering-No.
3	99-9207-00-03	3	99-9208-00-03
4	99-9211-00-04	4	99-9212-00-04
5	99-9215-00-05	5	99-9216-00-05
8	99-9227-00-08	8	99-9228-00-08

Technische Daten
Specifications

Polzahl	3	4	5	8	Number of contacts
Steckverbinder Verriegelung	schnapp/snap-in				Connector locking system
Anschlussart	löten/solder				Termination
Anschlussquerschnitt	max. 0,25 mm ² (max. AWG 24)				Wire gauge
Kabeldurchlass	3-5 mm				Cable outlet
Schutzart	IP67				Degree of protection
Mechanische Lebensdauer	> 500 Steckzyklen/> 500 mating cycles				Mechanical operation
Obere Grenztemperatur	+ 85 °C				Upper temperature
Untere Grenztemperatur	- 25 °C				Lower temperature
Bemessungsspannung	125 V			63 V	Rated voltage
Bemessungsstoßspannung	1500 V			800 V	Rated impulse voltage
Verschmutzungsgrad	2				Pollution degree
Überspannungskategorie	II				Overvoltage category
Isolierstoffgruppe	II				Material group
Bemessungsstrom (40°C)	3 A	2,5 A	2 A	1 A	Rated current (40 °C)
Durchgangswiderstand	≤ 3 mΩ				Contact resistance
Material Kontakt	Stift/pin CuZn (Messing/brass), Buchse/socket CuSn (Bronze/bronze)				Material of contact
Kontaktoberfläche	Au (Gold/gold)				Contact plating
Material Kontaktkörper	PA (UL 94 V-0)				Material of contact body
Material Gehäuse	PA (UL 94 V-0)				Material of housing

- ü
- TI
- SI IP40
- SI IP67
- Bayonett
- PP IP67
- M9 IP40
- M9 IP67
- SI IP67
- Bayonett
- PP IP67
- M16 IP40
- M16 IP67
- M23
- Bayonett
- M25
- RD24
- RD30
- M5
- M8
- M12-A
- VL
- M12 PP
- Verteiler
- M12-B
- M12-D
- M12-US
- M18
- 7/8"
- BFA
- BFB
- BFC
- R

Subminiatursteckverbinder Serie 620
Subminiature connectors series 620

Einzelteildarstellung
 Component part drawing

Kabelsteckverbinder
 Cable connectors

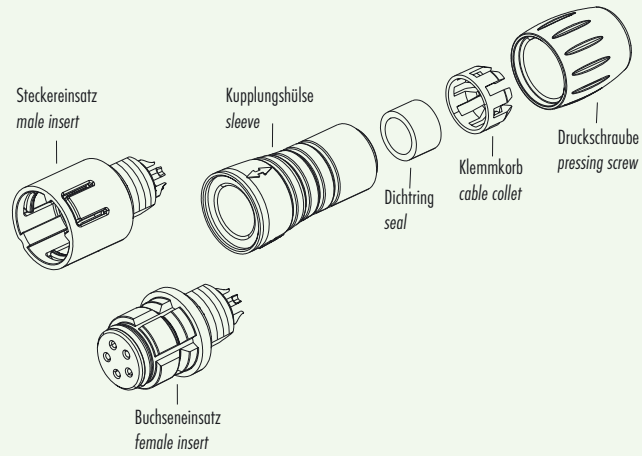

Flanschsteckverbinder
 Socket connectors

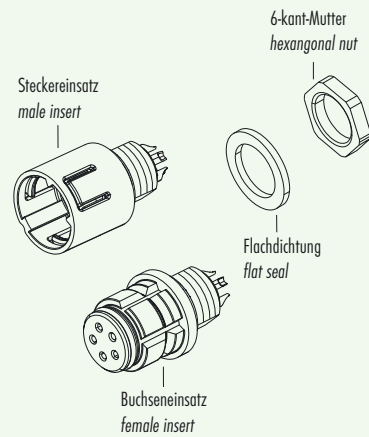

Adapter
 Adapter

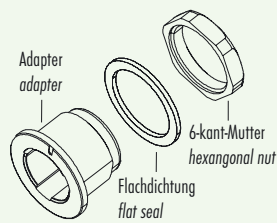

Adapter, von vorn verschraubt
 Adapter, front fastened

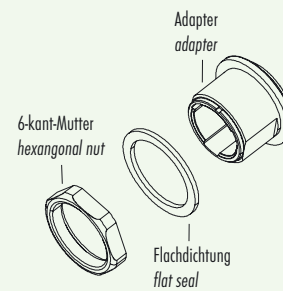

- ü
- TI
- SI IP40
- SI IP67**
- Bajonett
- PP IP67
- M9 IP40
- M9 IP67
- M9 IP67
- SI IP67
- Bajonett
- PP IP67
- M16 IP40
- M16 IP67
- M16 IP67
- M23
- Bajonett
- M25
- RD24
- RD30
- M5
- M8
- M12-A
- VL
- M12 PP
- Verteiler
- M12-B
- M12-D
- M12-US
- M18
- 7/8"
- BFA
- BF-B
- BF-C
- R



Ü

TI

SI IP40

SI IP67

Bajonet

PP IP67

M9 IP40

M9 IP67

SI IP67

Bajonet

PP IP67

M16 IP40

M16 IP67

M23

Bajonet

M25

RD24

RD30

M5

M8

M12-A

VL

M12-PP

Verteiler

M12-B

M12-D

M12-US

M18

7/8"

BF-A

BF-B

BF-C

R



Snap-in IP67

Subminiatursteckverbinder Serie 620 Subminiature connectors series 620

Polbilder
Contact arrangements

Stifteinsatz (Steckseite)
Male insert (mating side)

Buchseinsatz (Steckseite)
Female insert (mating side)

3 pol
3 contacts

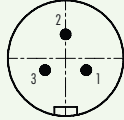

	X	Y
1	1,82	-1,05
2	0,00	2,10
3	-1,82	-1,05

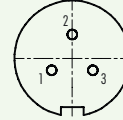

	X	Y
1	-1,82	-1,05
2	0,00	2,10
3	1,82	-1,05

4 pol
4 contacts

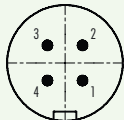

	X	Y
1	1,55	-1,55
2	1,55	1,55
3	-1,55	1,55
4	-1,55	-1,55

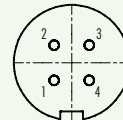

	X	Y
1	-1,55	-1,55
2	-1,55	1,55
3	1,55	1,55
4	1,55	-1,55

5 pol
5 contacts



	X	Y
1	1,23	-1,70
2	2,00	0,65
3	0,00	2,10
4	-2,00	0,65
5	-1,23	-1,70



	X	Y
1	-1,23	-1,70
2	-2,00	0,65
3	0,00	2,10
4	2,00	0,65
5	1,23	-1,70

8 pol
8 contacts

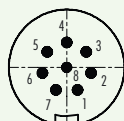

	X	Y
1	0,96	-1,98
2	2,15	-0,49
3	1,72	1,37
4	0,00	2,20
5	-1,72	1,37
6	-2,15	-0,49
7	-0,96	-1,98
8	0,00	0,00

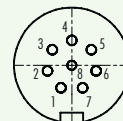

	X	Y
1	-0,96	-1,98
2	-2,15	-0,49
3	-1,72	1,37
4	0,00	2,20
5	1,72	1,37
6	2,15	-0,49
7	0,96	-1,98
8	0,00	0,00

Montageausschnitt
Panel cut out

Flanschsteckverbinder
Socket connectors

Adapter
Adapter

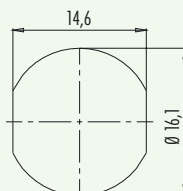
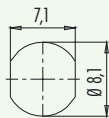



Ü

TI

SI IP40

SI IP67

Baionett

PP IP67

M9 IP40

M9 IP67

SI IP67

Baionett

PP IP67

M16 IP40

M16 IP67

M23

Baionett

M25

RD24

RD30

M5

M8

M12-A

VL

M12 PP

Verteiler

M12-B

M12-D

M12-US

M18

7/8"

BFA

BF-B

BF-C

R



Snap-in IP67

Subminiatursteckverbinder Serie 620 Subminiature connectors series 620

Bezeichnung
Description

Adapter für Flanschsteckverbinder
Adapter for sockets

Adapter für Flanschsteckverbinder ,
von vorn verschraubt
Adapter for sockets,
front fastened

Abbildung
Figure



Maßzeichnung
Drawing

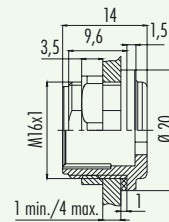
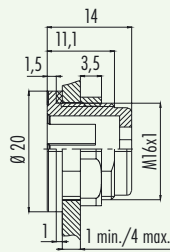

Bestell-Nr.
Ordering-No.

Bestell-Nr.
Ordering-No.

08-2636-000-001

Bestell-Nr.
Ordering-No.

08-2629-000-001

Technische Daten Specifications

Polzahl	-	Number of contacts
Steckverbinder Verriegelung	-	Connector locking system
Anschlussart	-	Termination
Anschlussquerschnitt	-	Wire gauge
Kabeldurchlass	-	Cable outlet
Schutzart	-	Degree of protection
Mechanische Lebensdauer	-	Mechanical operation
Obere Grenztemperatur	-	Upper temperature
Untere Grenztemperatur	-	Lower temperature
Bemessungsspannung	-	Rated voltage
Bemessungsstoßspannung	-	Rated impulse voltage
Verschmutzungsgrad	-	Pollution degree
Überspannungskategorie	-	Overvoltage categorie
Isolierstoffgruppe	-	Material group
Bemessungsstrom (40°C)	-	Rated current (40 °C)
Durchgangswiderstand	-	Contact resistance
Material Kontakt	-	Material of contact
Kontaktoberfläche	-	Contact plating
Material Kontaktkörper	-	Material of contact body
Material Gehäuse	-	Material of housing

5 Snap-in IP67



X-ON Electronics

Largest Supplier of Electrical and Electronic Components

Click to view similar products for [binder manufacturer](#):

Other Similar products are found below :

[16-8085-001](#) [16-8100-000](#) [16-8090-000](#) [16-8093-000](#) [09 0330 00 12](#) [09 0153 70 08](#) [09 0305 00 03](#) [09 0337 00 16](#) [09 0477 00 07](#) [09 9478 00 07](#) [66-0004-001](#) [99-9125-60-08](#) [99-9106-60-03](#) [99 0079 100 04](#) [79-3108-52-04](#) [79-3110-52-04](#) [66-0003-001](#) [99-3782-200-08](#) [61-0903-139 09 5283 00 03](#) [09-0316-702-05](#) [66-0005-000](#) [02-0055-001](#) [09-5288-00-08](#) [09-0104-300-02](#) [09-0110-25-04](#) [09-0112-782-04](#) [09-0173-300-08](#) [09-0312-290-04](#) [99-4218-300-07](#) [09-3442-92-05](#) [99-0437-186-05](#) [99-0218-210-07](#) [43-1706-000-04](#) [08-2809-000-000](#) [99-9205-050-03](#) [99-0201-00-07](#) [09-0312-09-04](#) [99-0610-02-04](#) [09-0319-80-05](#) [99-9206-050-03](#) [09-0073-20-02](#) [09-0081-20-04](#) [09-0322-92-06](#) [99-2026-20-07](#) [43-1714-133-03](#) [99-0143-12-06](#) [99-0142-12-05](#) [99-3400-400-03](#) [99-2009-210-04](#)