



ü

TI

SI IP40

SI IP67

Bajonett

PP IP67

M9 IP40

M9 IP67

SI IP67

Bajonett

PP IP67

M16 IP40

M16 IP67

M23

Bajonett

M25

RD24

RD30

M5

M8

M12-A

VL

M12 PP

Verteiler

M12-B

M12-D

M12-US

M18

7/8"

BFA

BFB

BFC

R

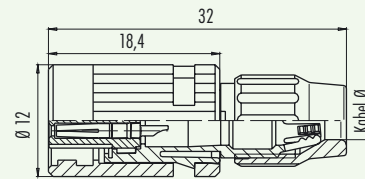
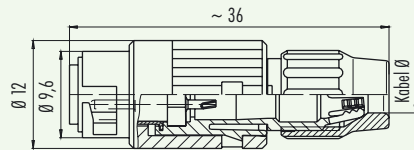
binder**Bajonett****Subminiatursteckverbinder Serie 710**
Subminiature connectors series 710**Bezeichnung**
*Description***Kabelstecker**
*Male cable connector***Kabeldose**
*Female cable connector***Abbildung**
Figure**Maßzeichnung**
Drawing**Bestell-Nr.**
Ordering-No.

Polzahl Contacts	Kabeldurchlass 3-4mm Cable outlet 3-4mm	Kabeldurchlass 4-5mm Cable outlet 4-5mm	Polzahl Contacts	Kabeldurchlass 3-4mm Cable outlet 3-4mm	Kabeldurchlass 4-5mm Cable outlet 4-5mm
2	99-0971-100-02	99-0971-102-02	2	99-0972-100-02	99-0972-102-02
3	99-0975-100-03	99-0975-102-03	3	99-0976-100-03	99-0976-102-03
4	99-0979-100-04	99-0979-102-04	4	99-0980-100-04	99-0980-102-04
5	99-0995-100-05	99-0995-102-05	5	99-0996-100-05	99-0996-102-05
7	99-9475-100-07	99-9475-102-07	7	99-9476-100-07	99-9476-102-07
8	99-9479-100-08	99-9479-102-08	8	99-9480-100-08	99-9480-102-08

Technische Daten
Specifications

Polzahl	2	3	4	5	7	8	Number of contacts
Steckverbinder Verriegelung	Bajonett/bayonet						Connector locking system
Anschlussart	löten/solder						Termination
Anschlussquerschnitt	max. 0,25 mm ² (max. AWG 24)			max. 0,14 mm ² (max. AWG 26)			Wire gauge
Kabeldurchlass	3-4 mm/4-5 mm						Cable outlet
Schutzart	IP40						Degree of protection
Mechanische Lebensdauer	> 500 Steckzyklen/> 500 mating cycles						Mechanical operation
Obere Grenztemperatur	+ 85 °C						Upper temperature
Untere Grenztemperatur	- 40 °C						Lower temperature
Bemessungsspannung	125 V						Rated voltage
Bemessungsstoßspannung	1500 V						Rated impulse voltage
Verschmutzungsgrad	I						Pollution degree
Überspannungskategorie	II						Overvoltage categorie
Isolierstoffgruppe	III						Material group
Bemessungsstrom (40°C)	4 A		3 A		1 A		Rated current (40 °C)
Durchgangswiderstand	≤ 3 mΩ						Contact resistance
Material Kontakt	Stift/pin CuZn (Messing/brass), Buchse/socket CuSn (Bronze/bronze)						Material of contact
Kontaktoberfläche	Au (Gold/gold)						Contact plating
Material Kontaktkörper	PA (UL 94 V-0)						Material of contact body
Material Gehäuse	PA (UL 94 HB)						Material of housing

3 Bajonett



- ü
- TI
- SI P40
- SI P67
- Bajonett
- PP IP67
- M9 IP40
- M9 IP67
- SI IP67
- Bajonett
- PP IP67
- M16 IP40
- M16 IP67
- M23
- Bajonett
- M25
- RD24
- RD30
- M5
- M8
- M12-A
- VL
- M12 PP
- Verteiler
- M12-B
- M12-D
- M12-US
- M18
- 7/8"
- BF-A
- BF-B
- BF-C
- R



Bajonett

Subminiatursteckverbinder Serie 710 Subminiature connectors series 710

Einzelteildarstellung
Component part drawing

Kabelstecker
Male cable connectors

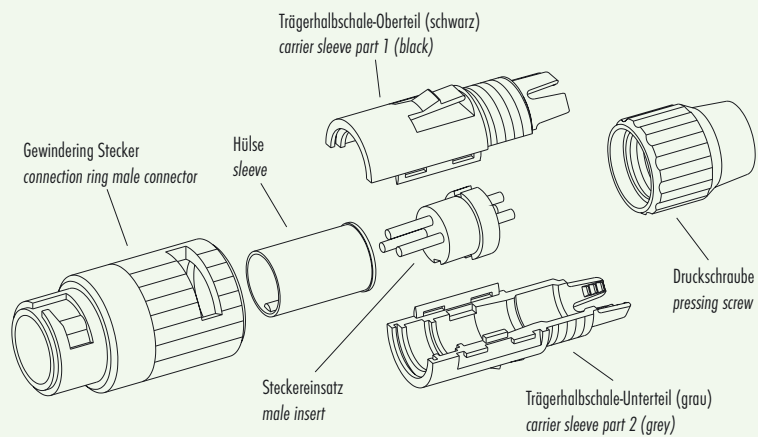

Kabeldose
Female cable connectors

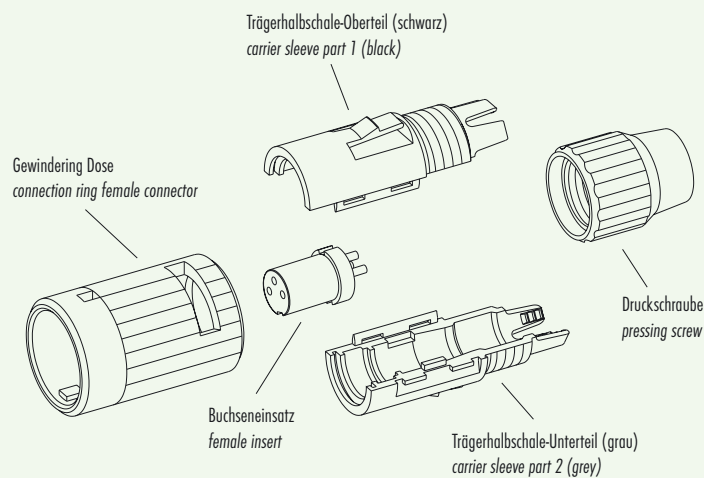

Subminiatursteckverbinder Serie 710 Subminiature connectors series 710

Zubehör Accessories

Abbildung
Figure

Montageschlüssel
Mounting spanner

Maßzeichnung
Drawing

Bestell-Nr.
Ordering-No.

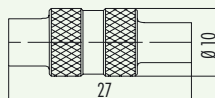

01-5059-001



Subminiatursteckverbinder Serie 710 Subminiature connectors series 710

Polbilder
Contact arrangements

Stifteinsatz (Steckseite)
Male insert (mating side)

Buchseinsatz (Steckseite)
Female insert (mating side)

2 pol
2 contacts

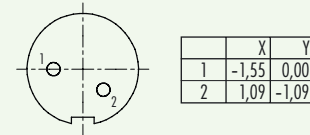
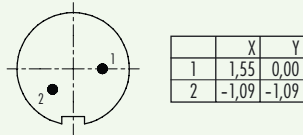

3 pol
3 contacts

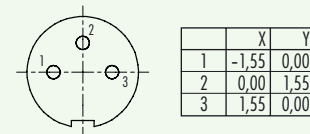
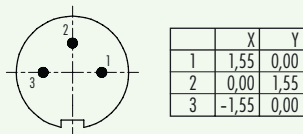

4 pol
4 contacts

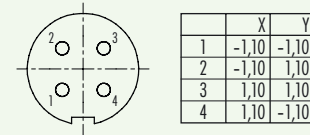
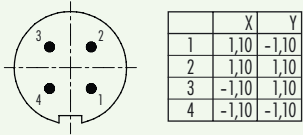

5 pol
5 contacts

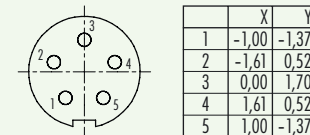
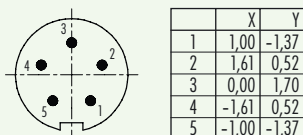

7 pol
7 contacts

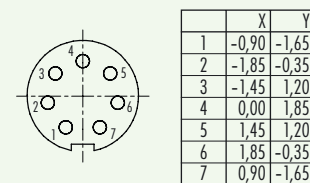
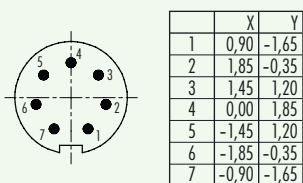

8 pol
8 contacts

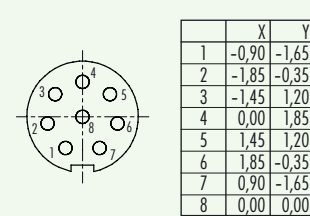
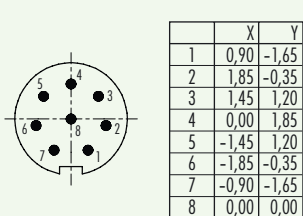

Montageausschnitt
Panel cut out

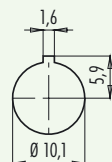

- i
- TI
- SI IP40
- SI IP67
- Bajonett
- PP IP67
- PP IP40
- M9 IP67
- M9 IP67
- SI IP67
- Bajonett
- PP IP67
- M16 IP40
- M16 IP67
- M16 IP67
- M23
- Bajonett
- M25
- RD24
- RD30
- M5
- M8
- M12-A
- VL
- M12 PP
- Verteiler
- M12-B
- M12-D
- M12-US
- M12-US
- M18
- 7/8"
- BF-A
- BF-B
- BF-C
- R

X-ON Electronics

Largest Supplier of Electrical and Electronic Components

Click to view similar products for [binder manufacturer](#):

Other Similar products are found below :

[16-8085-001](#) [16-8100-000](#) [16-8090-000](#) [16-8093-000](#) [09 0330 00 12](#) [09 0153 70 08](#) [09 0305 00 03](#) [09 0337 00 16](#) [09 0477 00 07](#) [09 9478 00 07](#) [66-0004-001](#) [99-9125-60-08](#) [99-9106-60-03](#) [99 0079 100 04](#) [79-3108-52-04](#) [79-3110-52-04](#) [66-0003-001](#) [99-3782-200-08](#) [61-0903-139 09 5283 00 03](#) [09-0316-702-05](#) [66-0005-000](#) [02-0055-001](#) [09-5288-00-08](#) [09-0104-300-02](#) [09-0110-25-04](#) [09-0112-782-04](#) [09-0173-300-08](#) [09-0312-290-04](#) [99-4218-300-07](#) [09-3442-92-05](#) [99-0437-186-05](#) [99-0218-210-07](#) [43-1706-000-04](#) [08-2809-000-000](#) [99-9205-050-03](#) [99-0201-00-07](#) [09-0312-09-04](#) [99-0610-02-04](#) [09-0319-80-05](#) [99-9206-050-03](#) [09-0073-20-02](#) [09-0081-20-04](#) [09-0322-92-06](#) [99-2026-20-07](#) [43-1714-133-03](#) [99-0143-12-06](#) [99-0142-12-05](#) [99-3400-400-03](#) [99-2009-210-04](#)