

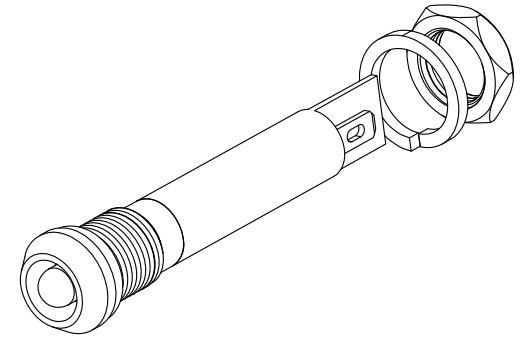

REV.	DESCRIPTION	DATE	APPROVED
A	Engineering Release	08/15/14	J. C.
B	Engineering Update w/o Changes	08/11/16	J. C.
C	Removed P/N Per EOL NOTICE 052317	07/24/17	J. C.

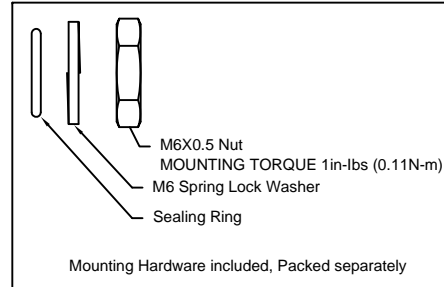
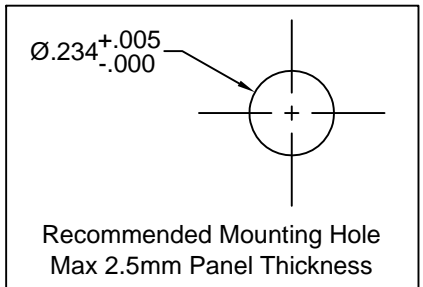
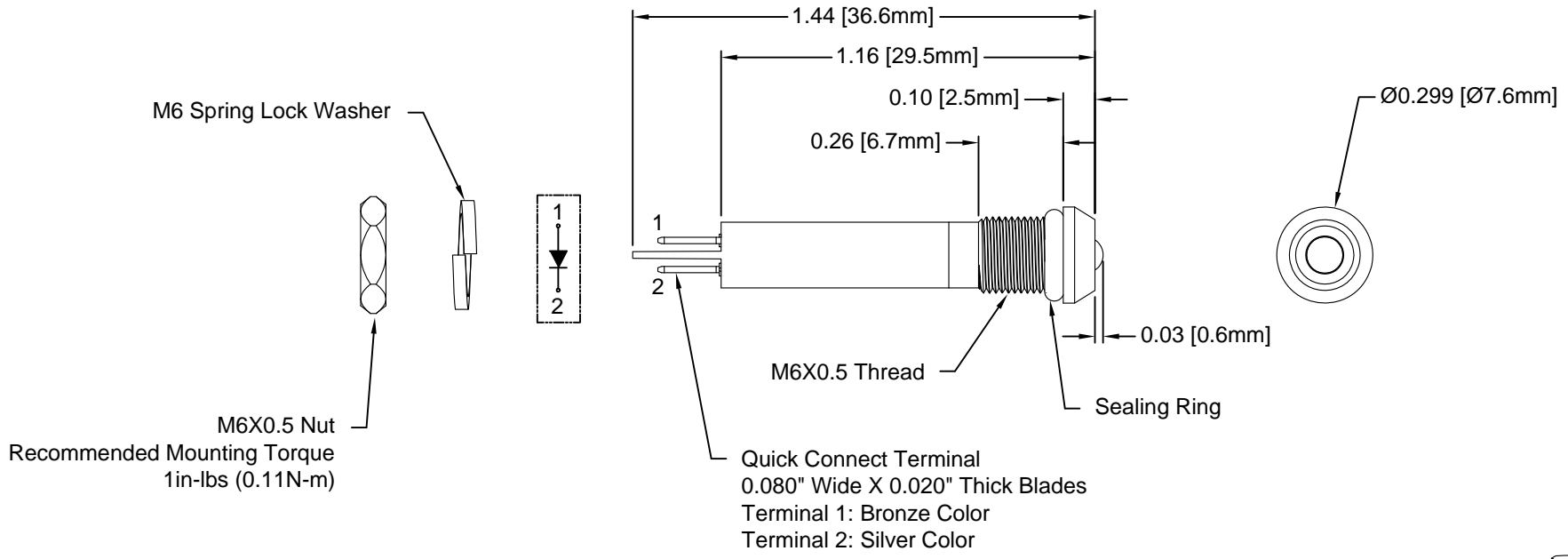

- NOTES:**
1. SEALED TO IP54 RATING
 2. VOLTAGE INPUT OPTIONS: 12V/24V
 3. ROHS COMPLIANT
 4. MOUNTING HARDWARE PACKED SEPARATELY NON-ASSEMBLED
 5. INSERT SEALING RING ON PANEL MOUNT ASSEMBLY PRIOR TO PANEL INSTALLATION

STANDARD TOLERANCE (UNLESS OTHERWISE SPECIFIED)		 4 THOMAS, IRVINE, CA. 92618 TEL: (949) 951-8808 FAX: (949) 951-3974	
DECIMALS	ANGULAR		
.X ± .1	X° ± 1°		TITLE: MPC6-1 SERIES, IP54 RATED PANEL MOUNT INDICATOR
.XX ± .02			
.XXX ± .010			
DESIGNED: M. Doan	DATE: 08/15/14	PART NO: MPC6-1XDXXV	REVISION: C
CHECKED: B. Oliver	DATE: 08/15/14	CAGE CODE : 32559	SHEET # 1 OF 2
CAD GENERATED DOCUMENT. DO NOT MEASURE DRAWING.			

REV.	DESCRIPTION	DATE	APPROVED
	SEE SHEET #1		

Part Number	Dominant Wave Length λ_d (nm)	Emitted Color	Lens Appearance	Voltage	Luminous Intensity (mcd)	Viewing Angle (degree)
MPC6-1RD12V	625	Red	Diffused	12V	310	45
MPC6-1GD12V	525	Green	Diffused	12V	2090	45
MPC6-1YD12V	590	Yellow	Diffused	12V	520	45
MPC6-1BWD12V	465	Blue	Diffused	12V	310	45
MPC6-1WD12V	x=0.28, y=0.30	White	Diffused	12V	2610	45
MPC6-1RD24V	625	Red	Diffused	24V	310	45
MPC6-1GD24V	525	Green	Diffused	24V	2090	45
MPC6-1YD24V	590	Yellow	Diffused	24V	520	45
MPC6-1BWD24V	465	Blue	Diffused	24V	310	45
MPC6-1WD24V	x=0.28, y=0.30	White	Diffused	24V	2610	45

ABSOLUTE MAXIMUM RATINGS (Ta = 25°C)

POWER INPUT _____ 0.5W MAX
 OPERATING TEMPERATURE RANGE _____ -40°C ~ 80°C
 STORAGE TEMPERATURE _____ -40°C ~ 80°C
 TERMINAL SOLDERING TEMPERATURE _____ 260°C, 5s

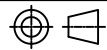
STANDARD TOLERANCE (UNLESS OTHERWISE SPECIFIED) DECIMALS ANGULAR		 4 THOMAS, IRVINE, CA. 92618 TEL: (949) 951-8808 FAX: (949) 951-3974	
			
DESIGNED: M. Doan	DATE: 08/15/14	TITLE: MPC6-1 SERIES, IP54 RATED PANEL MOUNT INDICATOR	
CHECKED: B. Oliver	DATE: 08/15/14	PART NO: MPC6-1XDXXV	REVISION: C
		CAGE CODE : 32559	SHEET # 2 OF 2
CAD GENERATED DOCUMENT. DO NOT MEASURE DRAWING.			

X-ON Electronics

Largest Supplier of Electrical and Electronic Components

Click to view similar products for [LED Panel Mount Indicators](#) category:

Click to view products by [Bivar](#) manufacturer:

Other Similar products are found below :

[607-3232-140F](#) [821-0331-503](#) [FL2870C8R](#) [FL2950WL7B](#) [FL2950WL8G](#) [FL589WL8R](#) [FL67C8R](#) [H8630FBBA3](#) [NL177WL2A](#)
[NL177WL3G](#) [NL276C2A](#) [NL2950BWL3G](#) [NL589WL2R](#) [NL67C2C](#) [NL67C3R](#) [C480AABG3](#) [PB22BM41K](#) [PB22SIM40Y](#)
[PB22SKRS31KC](#) [L32R-R2-2311](#) [L3353-MWRG](#) [L39UR-R24-2111](#) [L58D-G2-W](#) [L58D-Y2-W](#) [L59D-R12-W](#) [L59UD-R12-W](#) [L625DG](#)
[L625DR](#) [LE177WL39007](#) [LH1048BSWL3702](#) [LH1048BWL3702](#) [LH382A](#) [LH677G](#) [LHM628A](#) [FL276WL7R](#) [FL2950BWL7R](#)
[FL2950WL7R](#) [FL2950WL8R](#) [FL2950WL8R-12](#) [FL2951WL8G](#) [FL2951WL8R](#) [FL589C7R](#) [FL67WL8G](#) [MPC5BCW18.0](#) [556-1605-808F](#)
[556-1705-809F](#) [556-3008-839F](#) [558-0201-818F](#) [559-0001-813F](#) [559-1301-801F](#)