

ITEM	Q'TY	PART NUMBER	PART DESCRIPTION
1	1	PM5-3	LED Holder, 3-Lead Panel Mount, Press Fit, 5mm
2	1	5BC-3-XX	T1 ¼ (5mm) 3-Lead Shouldered Bi-Color LED, See Page 2.

REV.	DESCRIPTION	DATE	APPROVED
A	Engineering Release	12/02/08	T. Y.
B	Updated Recommended Mounting Hole	07/13/09	T. Y.
C	Updated 5BC-3 LED on Polarity Diagram	09/01/09	T. Y.

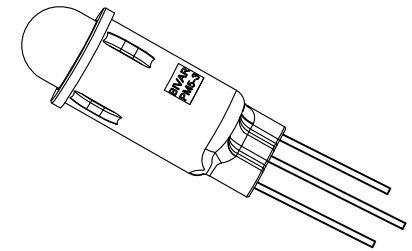
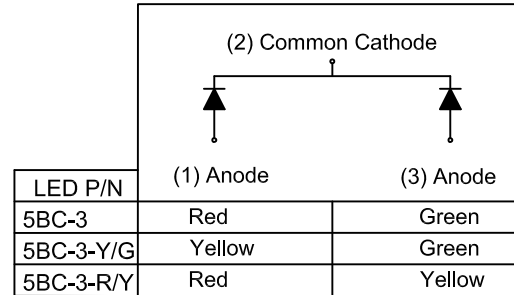
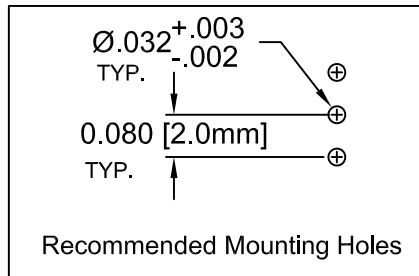
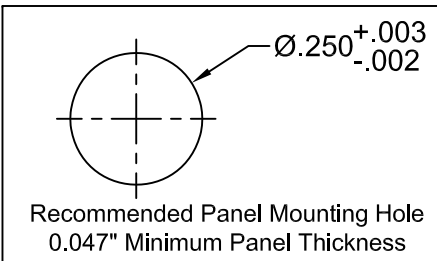
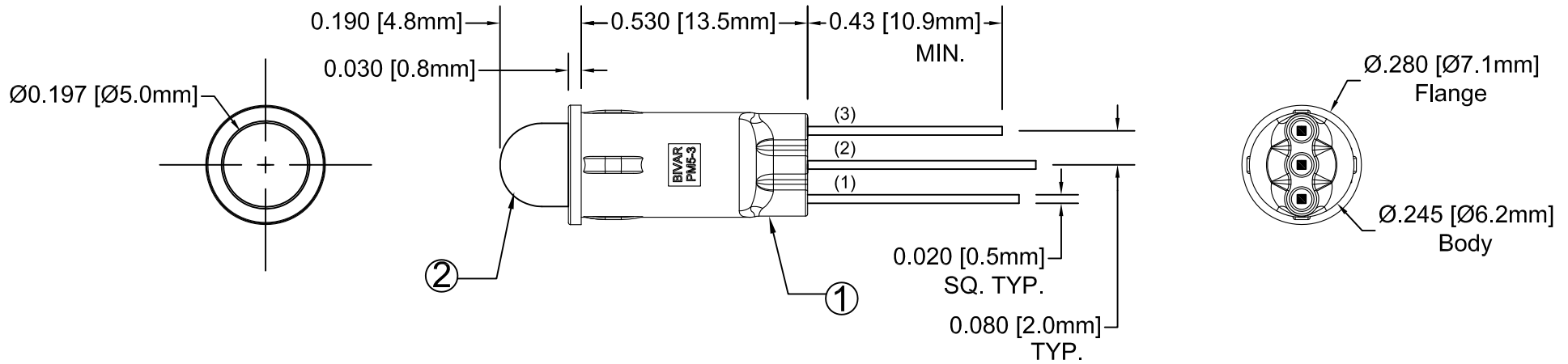

ABSOLUTE MAXIMUM RATINGS (Ta = 25°C)

REVERSE VOLTAGE	5V
REVERSE CURRENT (VR=5V)	100µA
OPERATING TEMPERATURE RANGE	-25°C ~ 85°C
STORAGE TEMPERATURE	-30°C ~ 100°C
LEAD SOLDERING TEMPERATURE (1/16" FROM BODY)	260°C for 5 Seconds



STANDARD TOLERANCE (UNLESS OTHERWISE SPECIFIED)		BIVAR®	
DECIMALS	ANGULAR	4 THOMAS, IRVINE, CA. 92618	
.X ± .1	X° ± 1°	TEL: (949) 951-8808 FAX: (949) 951-3974	
.XX ± .02		TITLE: T1 ¼ (5mm) PANEL MOUNT ASSEMBLY, 3-LEAD BI-COLOR	
.XXX ± .010		PART NO: PM53-XX	
DESIGNED: Brian Olliver	DATE: 12/02/08	REVISION: C	
CHECKED: F. Jensen	DATE: 12/02/08	CAGE CODE : 32559 SHEET # 1 OF 2	
CAD GENERATED DOCUMENT, DO NOT MEASURE DRAWING.			

REV.	DESCRIPTION	DATE	APPROVED
	SEE SHEET #1		

Assembly Part No.	Emitted Colors	LED Part No.
PM53-BC	RED/GREEN	5BC-3
PM53-YG	YELLOW/GREEN	5BC-3-Y/G
PM53-RY	RED/YELLOW	5BC-3-R/Y

PM53 - BC
├─── 3-Lead Panel Mount Series
└─── Emitted Colors

NOTES:
1. REFERENCE LED PRINTS FOR OPTICAL/ELECTRICAL SPECIFICATIONS

STANDARD TOLERANCE (UNLESS OTHERWISE SPECIFIED) <u>DECIMALS</u> <u>ANGULAR</u>		 BIVAR [®] 4 THOMAS, IRVINE, CA. 92618 TEL: (949) 951-8808 FAX: (949) 951-3974	
			
DESIGNED: Brian Oliver	DATE: 12/02/08	PART NO: PM53-XX	REVISION: C
CHECKED: F. Jensen	DATE: 12/02/08	CAGE CODE : 32559	SHEET # 2 OF 2
CAD GENERATED DOCUMENT, DO NOT MEASURE DRAWING.			

X-ON Electronics

Largest Supplier of Electrical and Electronic Components

Click to view similar products for [LED Panel Mount Indicators](#) category:

Click to view products by [Bivar](#) manufacturer:

Other Similar products are found below :

[607-3232-140F](#) [821-0331-503](#) [FL2870C8R](#) [FL2950WL7B](#) [FL2950WL8G](#) [FL589WL8R](#) [FL67C8R](#) [H8630FBBA3](#) [NL177WL2A](#)
[NL177WL3G](#) [NL276C2A](#) [NL2950BWL3G](#) [NL589WL2R](#) [NL67C2C](#) [NL67C3R](#) [C480AABG3](#) [PB22BM41K](#) [PB22SIM40Y](#)
[PB22SKRS31KC](#) [L32R-R2-2311](#) [L3353-MWRG](#) [L39UR-R24-2111](#) [L58D-G2-W](#) [L58D-Y2-W](#) [L59D-R12-W](#) [L59UD-R12-W](#) [L625DG](#)
[L625DR](#) [LE177WL39007](#) [LH1048BSWL3702](#) [LH1048BWL3702](#) [LH382A](#) [LH677G](#) [LHM628A](#) [FL276WL7R](#) [FL2950BWL7R](#)
[FL2950WL7R](#) [FL2950WL8R](#) [FL2950WL8R-12](#) [FL2951WL8G](#) [FL2951WL8R](#) [FL589C7R](#) [FL67WL8G](#) [MPC5BCW18.0](#) [556-1605-808F](#)
[556-1705-809F](#) [556-3008-839F](#) [558-0201-818F](#) [559-0001-813F](#) [559-1301-801F](#)