

ITEM	Q'TY	PART NUMBER	PART DESCRIPTION
1	1	ORFLP2-XXX	2mm Flexible Light Pipe ORCA Adapter w/ LED
2	1	FLPF-XX.X	Flexible Light Pipe Lens Cap Assembly, Flat

REV.	DESCRIPTION	DATE	APPROVED
A	Engineering Release.	09/14/09	T. Y.
B	Updated Table For Length "X.X"	11/14/12	T. Y.
C	Updated LED Optical Characteristics.	08/29/15	J. C.

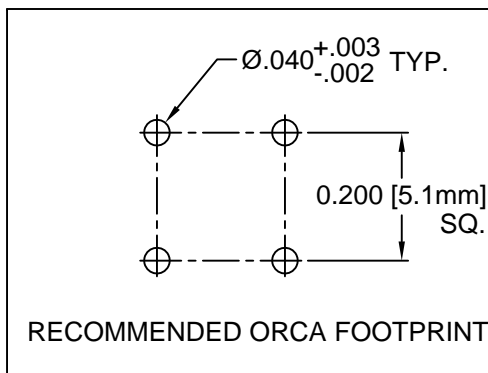
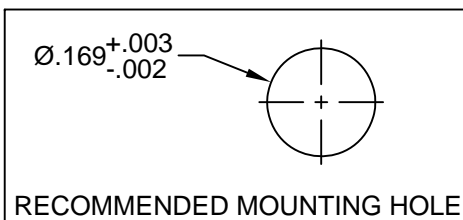
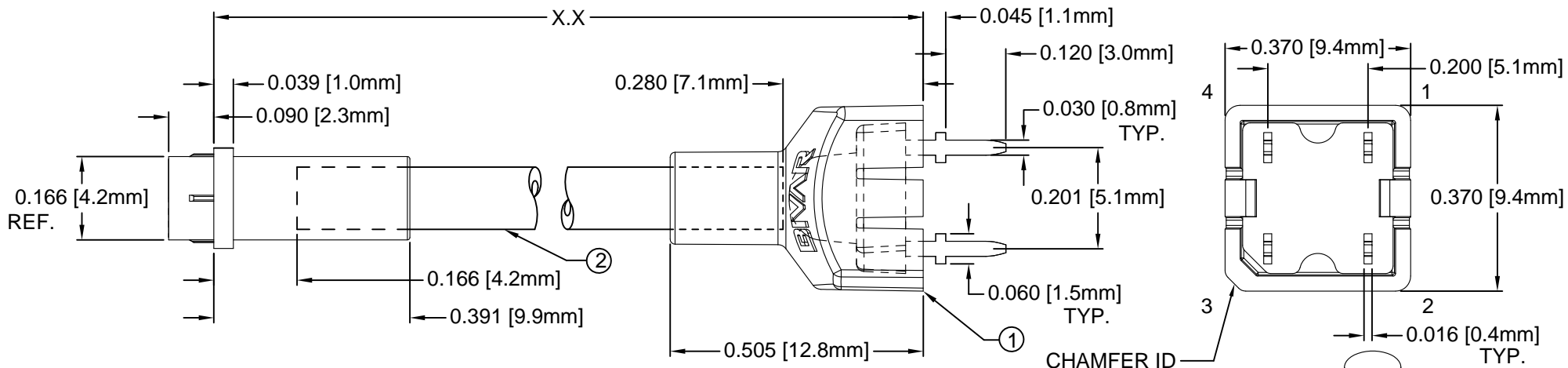

"X.X" *	Tolerance
1.0" ~ 16.0"	±0.050"
16.1" ~ 40.0"	±0.15"
40.1" ~ 80.0"	±0.30"
80.1" ~ 3,940.0"	±0.5%

* Available in 0.1" increments only

NOTE: ORFLP2-XXX ADAPTER SHIPPED SEPARATELY

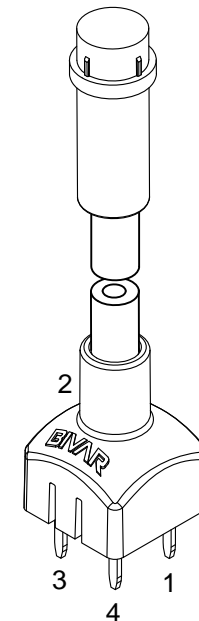

SEE PAGE 2 FOR POLARITY

ABSOLUTE MAXIMUM RATINGS (Ta=25°C)

REVERSE VOLTAGE _____	5V
REVERSE CURRENT _____	10uA
OPERATING TEMPERATURE RANGE _____	-25°C ~ +80°C
STORAGE TEMPERATURE _____	-30°C ~ +80°C
LEAD SOLDERING TEMPERATURE(1/16" FROM BODY) _____	260°C FOR 5 SECONDS

STANDARD TOLERANCE (UNLESS OTHERWISE SPECIFIED)		BIVAR®	
DECIMALS	ANGULAR	4 THOMAS, IRVINE, CA. 92618	
.X ± .2	X° ± 1°	TEL: (949) 951-8808 FAX: (949) 951-3974	
.XX ± .02		TITLE: 2mm FLP ORCA ASSEMBLY, FLAT LENS CAP	
.XXX ± .010		PART NO: R2F-X.X-XXX	
DESIGNED: Raffy Paje	DATE: 09/14/09	REVISION: C	
CHECKED: F. Jensen	DATE: 09/14/09	CAGE CODE : 32559 SHEET # 1 OF 2	
CAD GENERATED DOCUMENT. DO NOT MEASURE DRAWING.			

REV.	DESCRIPTION	DATE	APPROVED
	SEE SHEET #1		

Assy P/N	LED P/N	Emitted Color	Dominant Length λ_d (nm) / CCT (K)	Lens Appearance	Absolute Max. Ratings			Vf (V)			Iv (mcd)		Viewing Angle $2\theta_{1/2}$ (Deg)	POLARITY DIAGRAM
					Pd (mW)	If (mA)	Peak If (mA)	MIN	TYP	MAX	MIN	TYP		
SINGLE COLOR LED ASSEMBLIES (20mA)														
R2F-X.X-BLU	R20BLU-4-0045	BLUE	465 - 475	WATER CLEAR	220	50	100	2.7	3.2	3.6	5000	8000	45	FIG. A
R2F-X.X-GRN	R20GRN-4-0045	GREEN	517 - 527		220	50	100	2.7	3.2	3.6	15000	25000	45	FIG. A
R2F-X.X-WHT	R20WHT-4-0045	WHITE	6000K		220	50	100	2.7	3.2	3.6	10000	16000	45	FIG. A
SINGLE COLOR LED ASSEMBLIES (50mA)														
R2F-X.X-RED	R50RED-4-0045	RED	620 - 635	WATER CLEAR	140	80	160	1.8	2.4	2.6	12000	18000	45	FIG. A
R2F-X.X-YLW	R50YLW-4-0045	YELLOW	588 - 596		140	80	160	1.8	2.4	2.6	12000	18000	45	FIG. A
BI-COLOR LED ASSEMBLIES (50mA)														
R2F-X.X-RG	R50RG2-4-0045	RED	617 - 630	WATER CLEAR	150	80	160	1.8	2.4	2.6	3000	4000	45	FIG. B
		GREEN	515 - 525		220	80	150	3.0	3.4	3.8	6000	10000		
R2F-X.X-RB	R50RB2-4-0045	RED	617 - 630	WATER CLEAR	150	80	160	1.8	2.4	2.6	3000	4000	45	FIG. C
		BLUE	460 - 470		220	80	150	3.0	3.4	3.8	1000	3000		
R2F-X.X-BG	R50BG2-4-0045	BLUE	460 - 470	WATER CLEAR	220	80	150	3.0	3.4	3.8	1000	3000	45	FIG. D
		GREEN	515 - 525		220	80	150	3.0	3.4	3.8	6000	10000		
R2F-X.X-RGB	R50RGB-4-0045	RED	617 - 630	WATER CLEAR	150	80	160	1.8	2.4	2.6	3000	4000	45	FIG. E
		GREEN	515 - 525		220	80	150	3.0	3.4	3.8	6000	10000		
		BLUE	460 - 470		220	80	150	3.0	3.4	3.8	1000	3000		

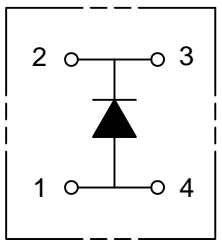

FIG. A

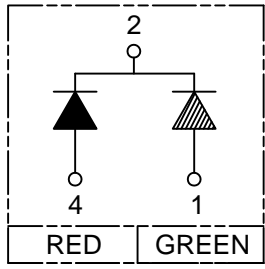

FIG. B

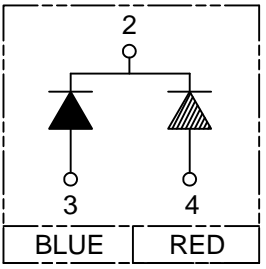

FIG. C

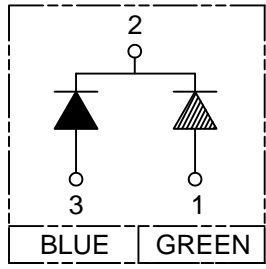

FIG. D

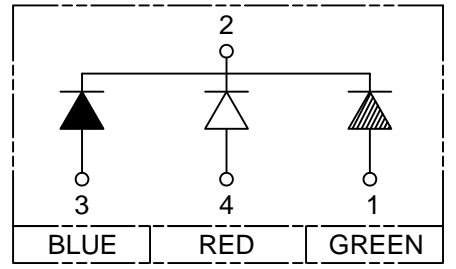

FIG. E

NOTES:
1. INDIVIDUAL LED P/N DATA AVAILABLE @ WWW.BIVAR.COM.

STANDARD TOLERANCE (UNLESS OTHERWISE SPECIFIED) DECIMALS ANGULAR		BIVAR [®] 4 THOMAS, IRVINE, CA. 92618 TEL: (949) 951-8808 FAX: (949) 951-3974	
DESIGNED: Raffy Paje		DATE: 09/14/09	
CHECKED: F. Jensen		DATE: 09/14/09	
		TITLE: 2mm FLP ORCA ASSEMBLY, FLAT LENS CAP	
		PART NO: R2F-X.X-XXX	
		REVISION: C	
		CAGE CODE : 32559 SHEET # 2 OF 2	
CAD GENERATED DOCUMENT. DO NOT MEASURE DRAWING.			

X-ON Electronics

Largest Supplier of Electrical and Electronic Components

Click to view similar products for [LED Light Pipes](#) category:

Click to view products by [Bivar](#) manufacturer:

Other Similar products are found below :

[1367627-1](#) [SLP3-300-450-F](#) [SLP3-400-450-R](#) [LPA-C011301S-6](#) [LPF-C011306S](#) [FLP25-1.95](#) [VLP-640-F](#) [LPA-C011301S-5.4](#) [LPA-C041301S-2](#) [LPA-R051171S-12](#) [LPA-S011331S](#) [515-1027-803F](#) [515-1217F](#) [SLP3-150-300-R](#) [SLP3-500-450-R](#) [515-1064-810F](#) [FLPV-SG](#) [BDL-1187](#) [7511A41](#) [7511A87-500](#) [FLPV-SBC](#) [5151064802F](#) [5151-192-0055-0DF](#) [LPF-R011340S](#) [515-1166-801F](#) [FLPF-6.0](#) [PM4-C1522-3.70](#) [LC-11.25](#) [CLP-1214](#) [515-1064-808F](#) [FLX3_05](#) [515-1192-0025-0DF](#) [HS LC-H-D2/R2XC1-2 54](#) [515-1192-80-3DF](#) [1282.2600](#) [1296.2004](#) [PBLP-1001-1](#) [SZ1-10.00-A220-F4P54](#) [SZ1-10.00-A220-F4P](#) [LC2-4.1](#) [1296.7042](#) [SF4-2.5-F5P](#) [PLP5-2-625-54](#) [FLP25-13.5](#) [1271.2002](#) [1272.0030](#) [1276.2004](#) [1281.1001-8MM](#) [1282.1300](#) [1296.1034](#)