

NOTES:

1. SEALED TO IP67 RATING
2. ROHS COMPLIANT
3. VERTICAL LIGHT PIPE PRE-ASSEMBLED WITH INSERT AND HOUSING. ANGLED LIGHT PIPE SHIPPED NON-ASSEMBLED
4. MOUNTING HARDWARE SHIPPED NON-ASSEMBLED

REVISIONS			
REV.	DESCRIPTION	DATE	APPROVED
A	ENGINEERING RELEASE	1/18/2021	A.V.
B	Updated Component Tables	2/16/2021	A.V.
C	Updated Descriptions	3/17/2021	A.V.

ANGLED LIGHT PIPE PART NUMBER CONFIGURATION

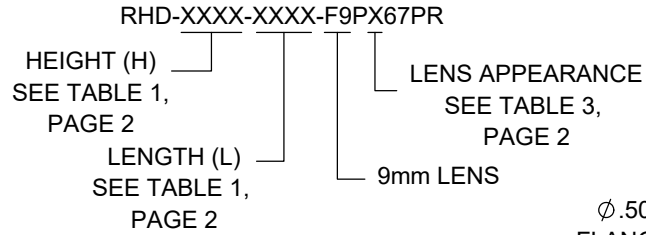

ANGLED LIGHT PIPE CONFIGURATION

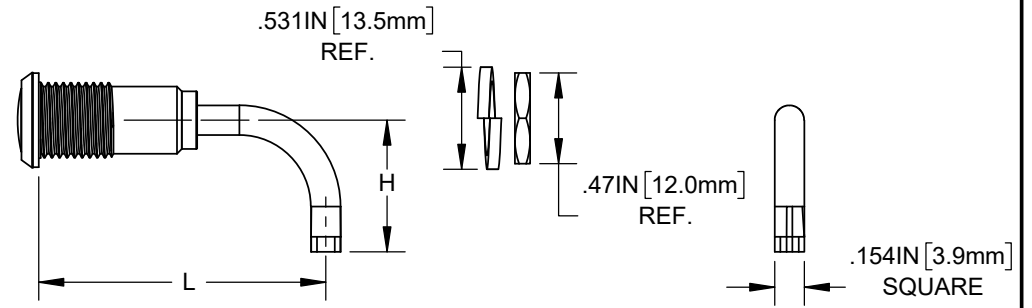

VERTICAL LIGHT PIPE PART NUMBER CONFIGURATION

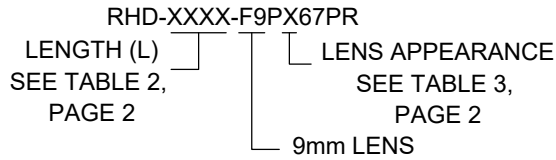

VERTICAL LIGHT PIPE CONFIGURATION

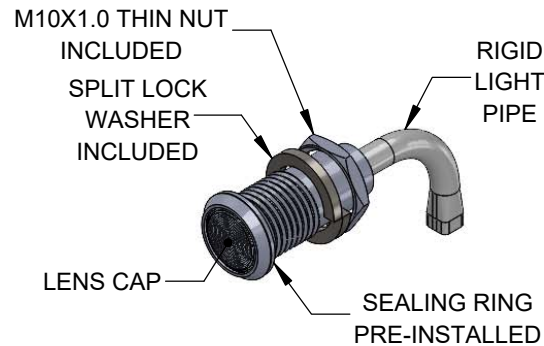
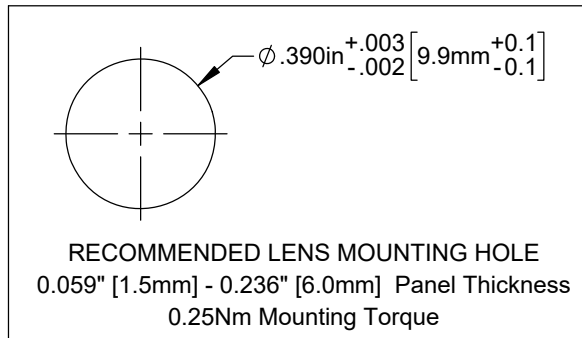
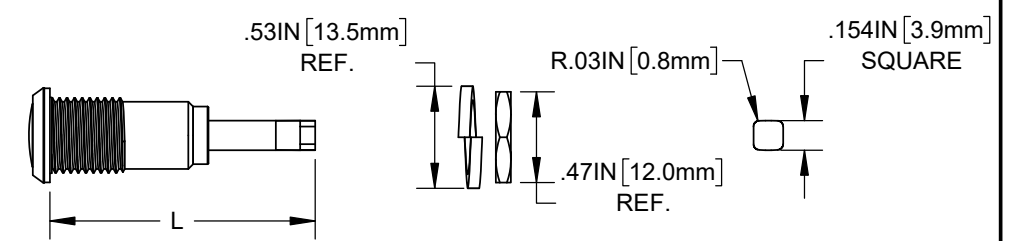

**CUSTOMER USE DRAWING**

STANDARD TOLERANCE (UNLESS OTHERWISE SPECIFIED)		 4 THOMAS, IRVINE, CA. 92618 TEL: (949) 951-8808 FAX: (949) 951-3974			
DECIMALS	ANGULAR				
.X ± .1	X° ± 1°	TITLE: IP67 Rigid Heavy Duty Light Pipe			
.XX ± .02					
.XXX ± .010		DESIGNED: K. BARON	DATE: 01/18/2021	DRAWING NO: RHD-XXXX-XXXX-F9PX67PR	REVISION: C
		REVISOR: K. BARON	DATE: 03/17/2021	SHEET SIZE: A	CAGE CODE: 32559
		CHECKED: A. VALDEZ	DATE: 03/17/2021	SCALE: 2:1	SHEET # 1 OF 2

CAD GENERATED DOCUMENT, DO NOT MEASURE DRAWING

TABLE 1 - ANGLED LIGHT PIPE		
ORDER CODE	HEIGHT (H)	LENGTH (L)
0700-1500	.686 [17.4mm]	1.496 [38.0mm]
0700-2000		1.996 [50.7mm]
0700-2500		2.496 [63.4mm]
0700-3000		2.996 [76.1mm]
0700-3500		3.496 [88.8mm]
0900-1500	.886" [22.5mm]	1.496 [38.0mm]
0900-2000		1.996 [50.7mm]
0900-2500		2.496 [63.4mm]
0900-3000		2.996 [76.1mm]
0900-3500		3.496 [88.8mm]
1100-1500	1.136 [28.9mm]	1.496 [38.0mm]
1100-2000		1.996 [50.7mm]
1100-2500		2.496 [63.4mm]
1100-3000		2.996 [76.1mm]
1100-3500		3.496 [88.8mm]

TABLE 2 - VERTICAL LIGHT PIPE	
ORDER CODE	LENGTH (L)
1140	1.132 [28.8mm]
1390	1.382 [30.1mm]
1640	1.632 [41.5mm]
1890	1.882 [47.8mm]
2140	2.132 [54.2mm]
2390	2.382 [60.5mm]

TABLE 3 - LENS APPEARANCE	
ORDER CODE	LENS APPEARANCE
Z	FRESNEL CLEAR
ZB	FRESNEL BLUE
ZG	FRESNEL GREEN
ZR	FRESNEL RED
ZY	FRESNEL YELLOW
(BLANK)	CLEAR
D	DIFFUSED
S	SMOKED

SAMPLE PART NUMBER - ANGLED LIGHT PIPE

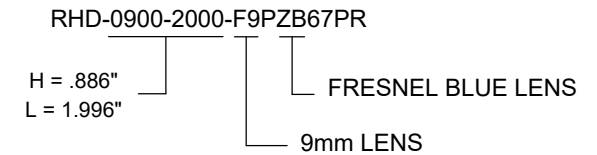

SAMPLE PART NUMBER - VERTICAL LIGHT PIPE

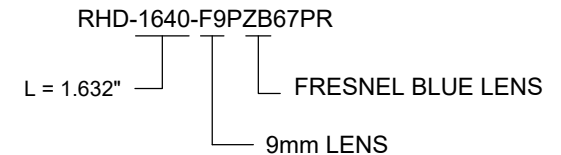

**CUSTOMER USE DRAWING**

		<b>BIVAR</b> <sup>®</sup>	
<b>CAGE CODE:</b>	<b>32559</b>	<b>DRAWING NO:</b> RHD-XXXX-XXXX-F9PX67PR	<b>REVISION:</b> <b>C</b>
<b>SHEET SIZE:</b>	<b>A</b>	SCALE: 2:1	<b>SHEET # 2 OF 2</b>
<small>CAD GENERATED DOCUMENT, DO NOT MEASURE DRAWING</small>			

## X-ON Electronics

Largest Supplier of Electrical and Electronic Components

*Click to view similar products for [LED Light Pipes](#) category:*

*Click to view products by [Bivar](#) manufacturer:*

Other Similar products are found below :

[1367627-1](#) [SLP3-300-450-F](#) [SLP3-400-450-R](#) [LPA-C011301S-6](#) [LPF-C011306S](#) [FLP25-1.95](#) [VLP-640-F](#) [LPA-C011301S-5.4](#) [LPA-C041301S-2](#) [LPA-R051171S-12](#) [LPA-S011331S](#) [515-1027-803F](#) [515-1217F](#) [SLP3-150-300-R](#) [SLP3-500-450-R](#) [515-1064-810F](#) [FLPV-SG](#) [BDL-1187](#) [7511A41](#) [7511A87-500](#) [FLPV-SBC](#) [5151064802F](#) [5151-192-0055-0DF](#) [LPF-R011340S](#) [515-1166-801F](#) [FLPF-6.0](#) [PM4-C1522-3.70](#) [LC-11.25](#) [CLP-1214](#) [515-1064-808F](#) [FLX3\\_05](#) [515-1192-0025-0DF](#) [HS LC-H-D2/R2XC1-2 54](#) [515-1192-80-3DF](#) [1282.2600](#) [1296.2004](#) [PBLP-1001-1](#) [SZ1-10.00-A220-F4P54](#) [SZ1-10.00-A220-F4P](#) [LC2-4.1](#) [1296.7042](#) [SF4-2.5-F5P](#) [PLP5-2-625-54](#) [FLP25-13.5](#) [1271.2002](#) [1272.0030](#) [1276.2004](#) [1281.1001-8MM](#) [1282.1300](#) [1296.1034](#)