

# SURFACE MOUNT LED GREEN, 0603 PACKAGE, 2mA

# BIVAR

## SM0603GCL

- ◆ Industry Standard 0603 Package
- ◆ RoHS Compliant
- ◆ Small Package and Footprint
- ◆ Low Current, 2mA
- ◆ Water Clear Lens
- ◆ Wide Viewing Angle
- ◆ Ideal for Status Indication, Display, and Backlighting

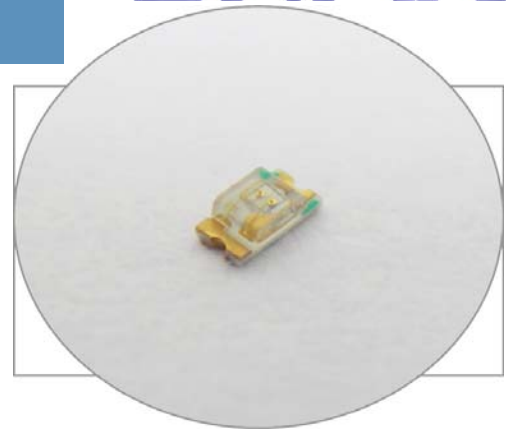

Bivar Surface Mount 0603 package LED may be used in nearly any lighting or indication application. The miniature package is ideal for small scale applications such as general indication and backlighting. Low power consumption and excellent long life reliability are suitable for battery powered equipment. Bivar offers water clear LED lens for maximum luminous intensity. Wide variety of wavelength and intensity combinations are available to meet any illumination need. The SM0603 LED is packaged in standard tape and reels for pick and place assemblies.

Part Number	Material	Emitted Color	Peak Wavelength $\lambda_p$ (nm) TYP.	Lens Appearance	Luminous Intensity (mcd) TYP.	Viewing Angle
SM0603GCL	AlGaInP	GREEN	575	Water Clear	3.6	130°

## Outline Dimensions

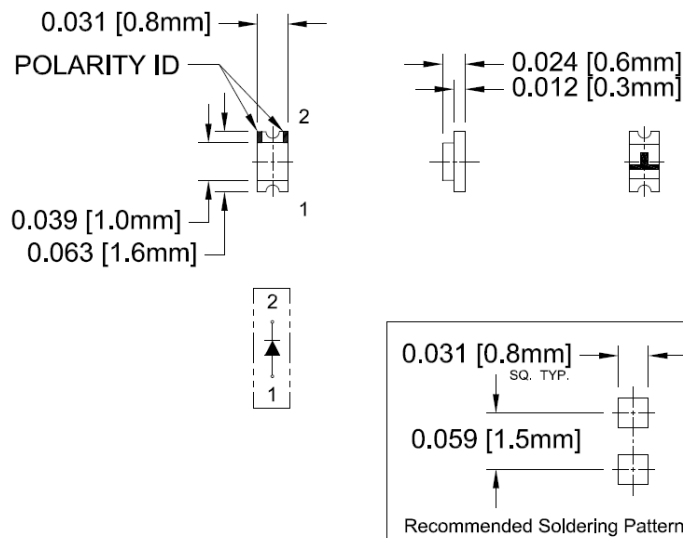

### Outline Drawings Notes:

1. All dimensions are in inches [millimeters].
2. Standard tolerance:  $\pm 0.010$ " unless otherwise noted.



Bivar reserves the right to make changes at any time without notice.

# SURFACE MOUNT LED GREEN, 0603 PACKAGE, 2mA



## Absolute Maximum Ratings

$T_A = 25^\circ\text{C}$  unless otherwise noted

Power Dissipation	78 mW
Forward Current ( DC )	30 mA
Peak Forward Current <sup>1</sup>	100 mA
Reverse Voltage	5 V
Operating Temperature Range	-30 ~ +80°C
Storage Temperature Range	-40 ~ +85°C
Lead Soldering Temperature ( 3 mm from the base of the epoxy bulb ) <sup>2</sup>	260°C

Notes: 1. 10% Duty Cycle, Pulse Width  $\leq$  0.1 msec.    2. Solder time less than 5 seconds at temperature extreme.

## Electrical / Optical Characteristics

$T_A = 25^\circ\text{C}$  &  $I_F = 2 \text{ mA}$  unless otherwise noted

Part Number	Forward Voltage (V) <sup>1</sup>			Recommend Forward Current (mA)			Reverse Current ( $\mu\text{A}$ )	Dominant Wavelength (nm) <sup>2</sup>			Luminous Intensity $I_v$ (mcd)			Viewing Angle $2\theta_{1/2}$ (deg)
	MIN	TYP	MAX	MIN	TYP	MAX	MAX	MIN	TYP	MAX	MIN	TYP	MAX	TYP
SM0603GCL	/	1.9	2.3	/	2	/	10	/	574	/	1.2	3.6	/	130

Notes: 1. Tolerance of forward voltage :  $\pm 0.05\text{V}$ .    2. Tolerance of dominant wavelength :  $\pm 1.0\text{nm}$ .

Bivar reserves the right to make changes at any time without notice.

# SURFACE MOUNT LED GREEN, 0603 PACKAGE, 2mA



## Typical Electrical / Optical Characteristics

$T_A = 25^\circ\text{C}$  unless otherwise noted

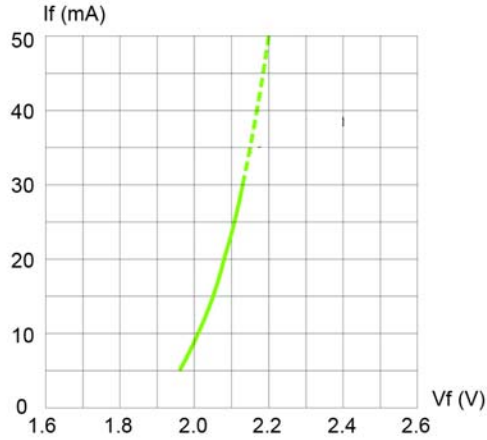

Fig. 1 Forward Current vs. Forward Voltage

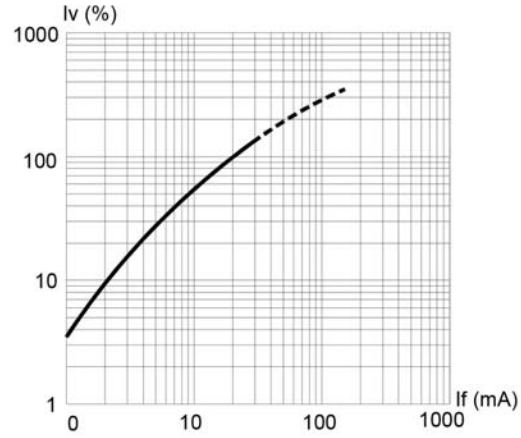

Fig. 2 Relative Luminous Intensity vs. Forward Current

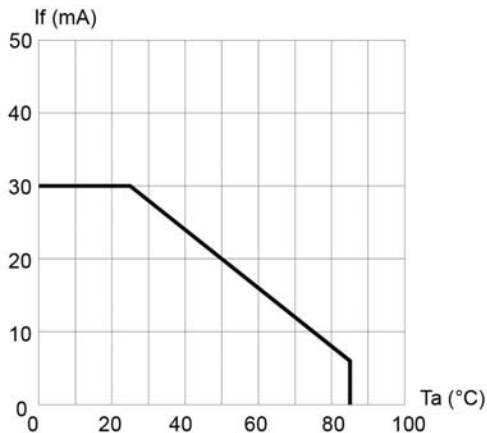

Fig. 3 Forward Current vs. Temperature

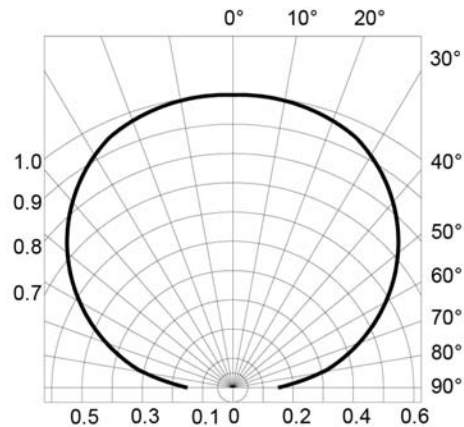

Fig. 4 Directivity Radiation Diagram

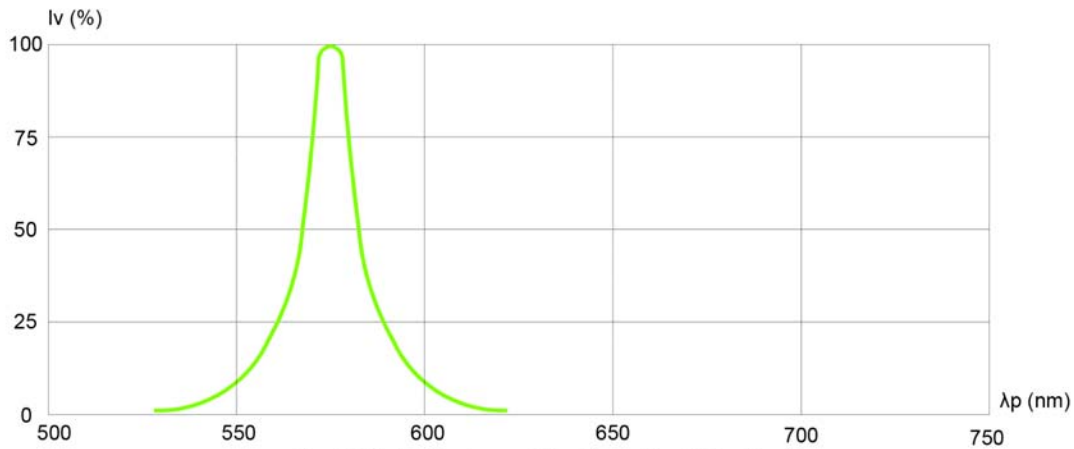

Fig. 5 Relative Luminous Intensity vs. Peak Wavelength

Bivar reserves the right to make changes at any time without notice.

# SURFACE MOUNT LED GREEN, 0603 PACKAGE, 2mA



## Recommended Soldering Conditions



## Tape and Reel Dimensions

Note: 4000 pcs/Reel

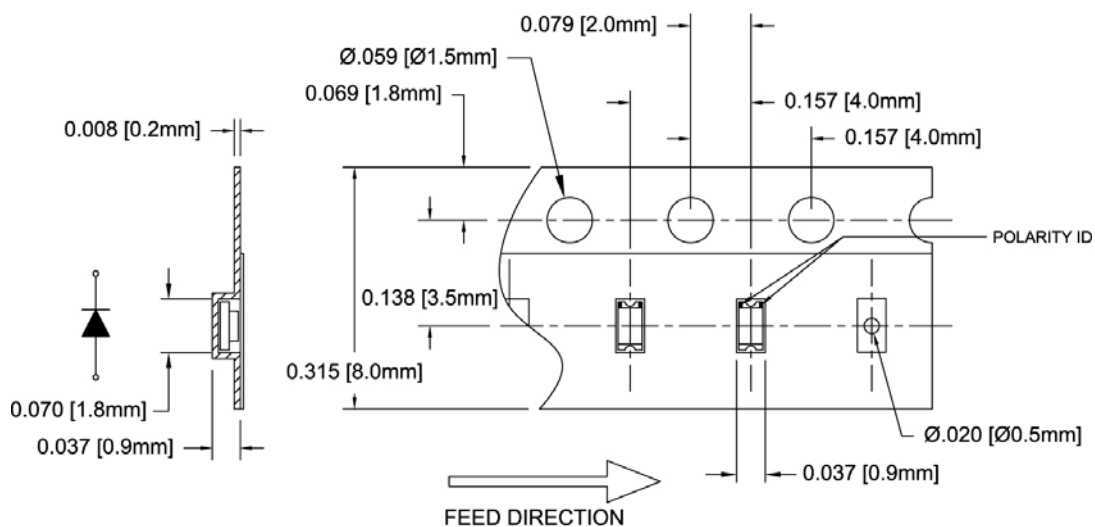

### Outline Drawings Notes:

1. All dimensions are in inches [millimeters].
2. Standard tolerance:  $\pm 0.010''$  unless otherwise noted.

Bivar reserves the right to make changes at any time without notice.

# SURFACE MOUNT LED GREEN, 0603 PACKAGE, 2mA



**Outline Drawings Notes:**

1. All dimensions are in inches [millimeters].
2. Standard tolerance unless otherwise noted: X.XXX ± 0.010"  
X.X ± 0.1"

## Packaging and Labeling Plan

Note: 1 Reel / Bag

Sealed ESD and Moisture Barrier Bag

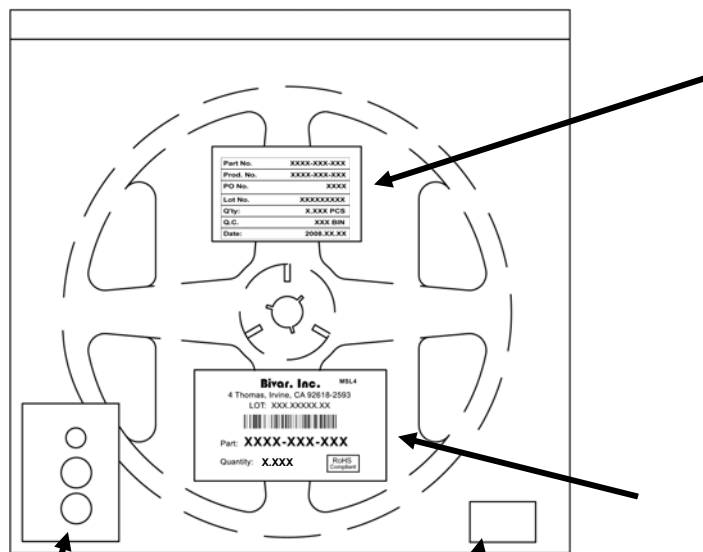

Humidity Indicator Card

Desiccant Card

Part No.	XXXX-XXX-XXX
Prod. No.	XXXX-XXX-XXX
PO No.	XXXX
Lot No.	XXXXXXXXXX
Q'ty:	X.XXX PCS
Q.C.	XXX BIN
Date:	2008.XX.XX

Internal Quality Control Label

**Bivar, Inc.** MSL4

4 Thomas, Irvine, CA 92618-2593  
LOT: XXX.XXXXX.XX



Part: **XXXX-XXX-XXX**

Quantity: **X.XXX**

RoHS Compliant

Bivar Standard Packaging Label

Bivar reserves the right to make changes at any time without notice.

## X-ON Electronics

Largest Supplier of Electrical and Electronic Components

*Click to view similar products for [Standard LEDs - SMD category](#):*

*Click to view products by [Bivar manufacturer](#):*

Other Similar products are found below :

[LTST-C19GD2WT](#) [LTST-N683GBEW](#) [LTW-170ZDC](#) [LTW-M140SZS40](#) [598-8110-100F](#) [598-8170-100F](#) [598-8610-202F](#) [67-22VRVGC/TR8](#) [AAAF5060QBFSEEZGS](#) [HLMP-6305-L0011](#) [ALMD-LB36-SV002](#) [APT1608QGW](#) [15-21UYC/S530-A3/TR8](#) [EASV1803BA0](#) [LG M67K-H1J2-24-0-2-R18-Z](#) [LS A676-P2S1-1](#) [SML310BATT86](#) [SML-512VWT86A](#) [SML-LX0606SISUGC/A](#) [SML-LXL1307SRC-TR](#) [SML-LXR851SIUPGUBC](#) [LT1ED53A](#) [FAT801-S](#) [AM27ZGC03](#) [APB3025SGNC](#) [APFA3010SURKCGKQBDC](#) [APHK1608VGCA](#) [APT2012QGW](#) [CLX6D-FKB-CN1R1H1BB7D3D3](#) [LTST-C250KGKT](#) [LTW-020ZDCG](#) [LTW-21TS5](#) [LTW-220DS5](#) [JANTXM19500/521-02](#) [UYGT801-S](#) [LO T67F-V1AB-24-1](#) [YGFR411-H](#) [SML-LX0402IC-TR](#) [CMDA20AYAA7D1S](#) [CMDA16AYDR7A1X](#) [339-1SURSYGW/S530-A2](#) [598-8040-100F](#) [598-8070-100F](#) [598-8140-100F](#) [598-8610-200F](#) [EAPL3527GA5](#) [67-11/BHC-M1N2B8Y/2A0](#) [SML-LXL1209SYC/ATR](#) [EASV3020YGA0](#) [EAST16086YA5](#)