

# SURFACE MOUNT LED YELLOW/GREEN, 0605 PACKAGE

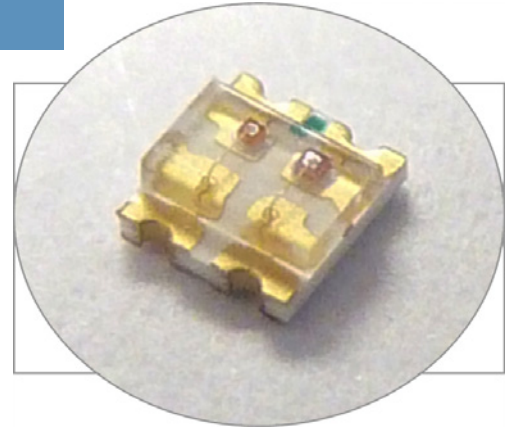

## SM0605BC-Y/G

- ◆ Industry Standard 0605 Package
- ◆ RoHS Compliant
- ◆ 2 Chips in One Small Package and Footprint
- ◆ Water Clear Lens
- ◆ Wide Viewing Angle
- ◆ Ideal for Status Indication, Display, and Backlighting

Bivar now offers its smallest Bi-Color Surface Mount LED to date which gives designers the edge they need for smaller board designs that require multiple color outputs. Its miniature size makes it ideal for almost any application where board space is a priority without compromise to quality, and it's long life and low power consumption are more than suitable for battery powered hand held devices and other portable products. This SM0605 LED is packaged in standard tape and reels for auto pick and place assemblies.

Part Number	Material	Emitted Color	Peak Wavelength $\lambda_p$ (nm) TYP.	Lens Appearance	Luminous Intensity (mcd) TYP.	Viewing Angle
SM0605BC-Y/G	AlGaInP	YELLOW	592	Water Clear	180	120°
	AlGaInP	GREEN	575		60	

## Outline Dimensions

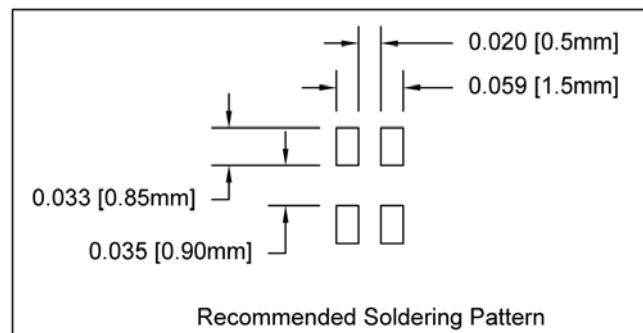
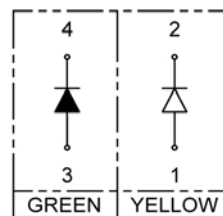
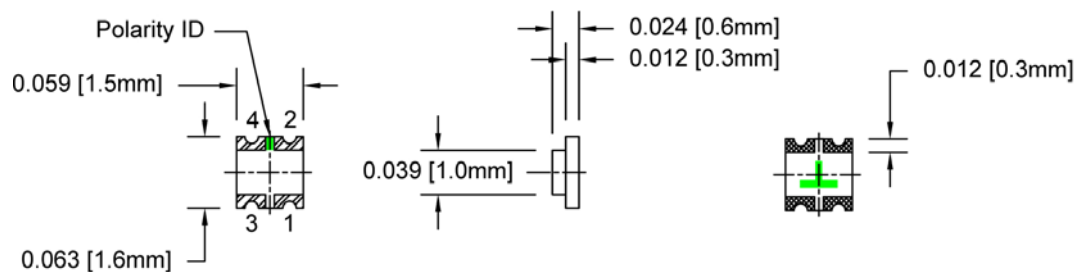

### Outline Drawings Notes:

1. All dimensions are in inches [millimeters].
2. Standard tolerance:  $\pm 0.10^\circ$  unless otherwise noted.



Bivar reserves the right to make changes at any time without notice.

# SURFACE MOUNT LED YELLOW/GREEN, 0605 PACKAGE



## Absolute Maximum Ratings

$T_A = 25^\circ\text{C}$  unless otherwise noted

Power Dissipation	Yellow - 78 mW Green - 78 mW
Continuous Forward Current	Yellow - 30 mA Green - 30 mA
Peak Forward Current <sup>1</sup>	100 mA
Reverse Voltage	5 V
Derating Linear From 25°C	0.4 mA/°C
Electrostatic Discharge (HBM)	2000 V
Operating Temperature Range	-30 ~ +80°C
Storage Temperature Range	-40 ~ +85°C
Lead Soldering Temperature <sup>2</sup>	260°C

Notes: 1.  $\leq 10\%$  Duty Cycle, Pulse Width  $\leq 0.1$  msec. 2. Solder time less than 5 seconds at temperature extreme.

## Electrical / Optical Characteristics

$T_A = 25^\circ\text{C}$  &  $I_F = 20$  mA unless otherwise noted

Part Number	Emitted Color	Forward Voltage (V)			Recommend Forward Current (mA)			Dominant Wavelength (nm)			Luminous Intensity $I_v$ (mcd)			Viewing Angle $2\theta_{1/2}$ (deg)
		MIN	TYP	MAX	MIN	TYP	MAX	MIN	TYP	MAX	MIN	TYP	MAX	TYP
SM0605BC-Y/G	Yellow	/	2.1	2.6	/	20	/	/	590	/	115	180	/	120
	Green	/	2.2	2.6	/	20	/	/	574	/	36	60	/	

## Typical Electrical / Optical Characteristics

$T_A = 25^\circ\text{C}$  &  $I_F = 20$  mA unless otherwise noted

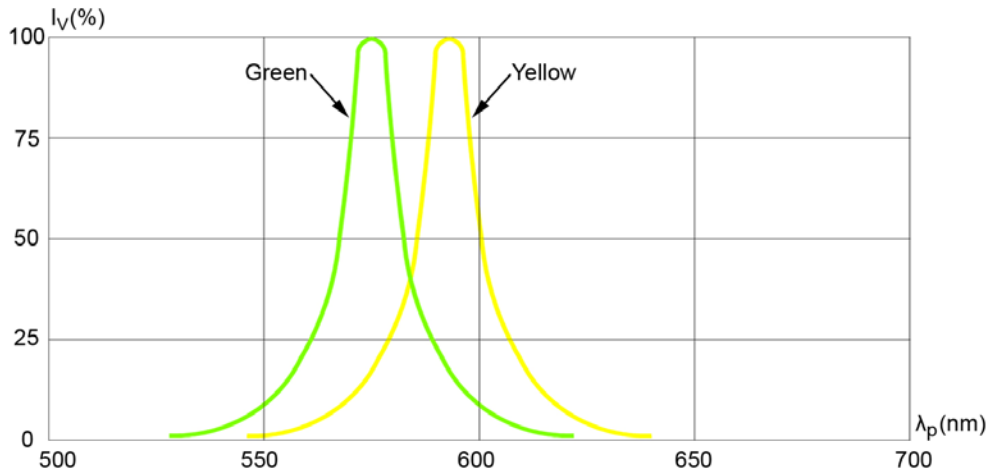

Fig. 1 Relative Luminous Intensity vs. Peak Wavelength

Bivar reserves the right to make changes at any time without notice.

## Typical Electrical / Optical Characteristics (Continued)

$T_A = 25^\circ\text{C}$  unless otherwise noted

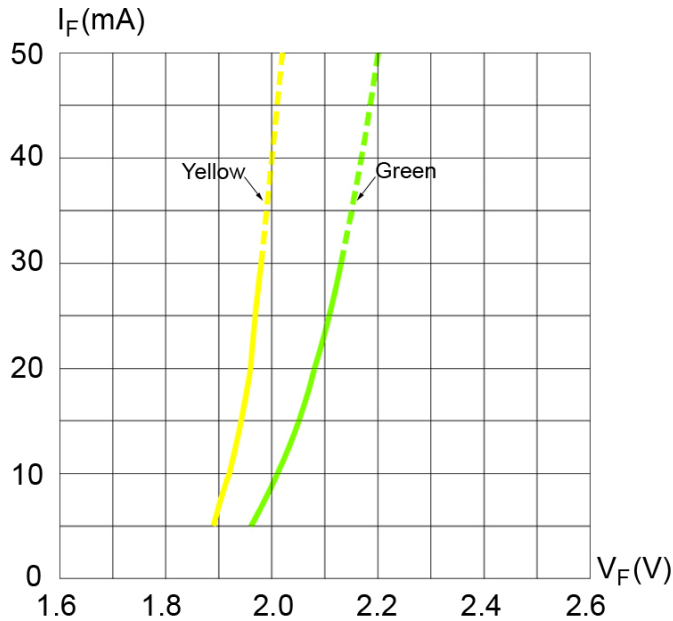

Fig. 2 Forward Current vs. Forward Voltage

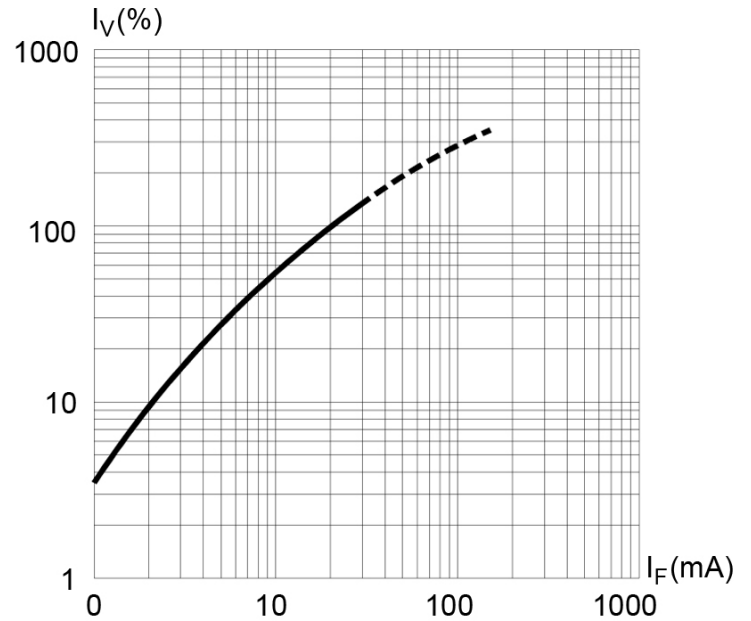

Fig. 3 Relative Luminous Intensity vs. Forward Current

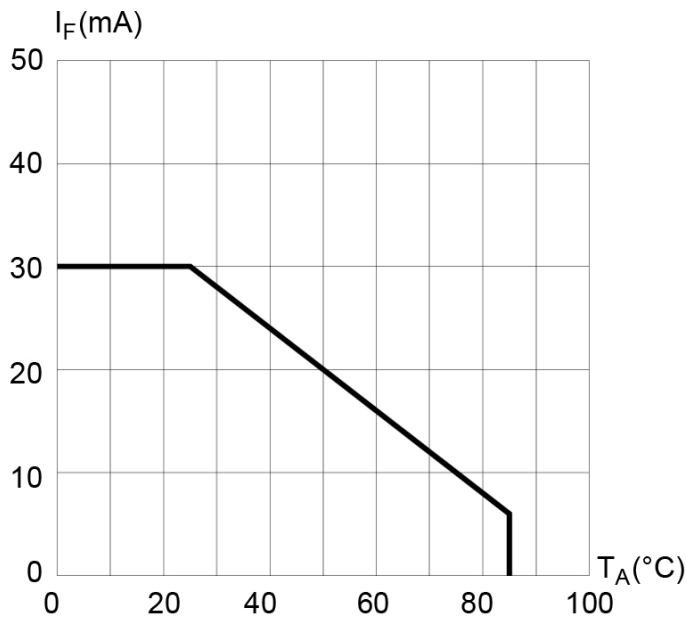

Fig. 4 Forward Current vs. Ambient Temperature

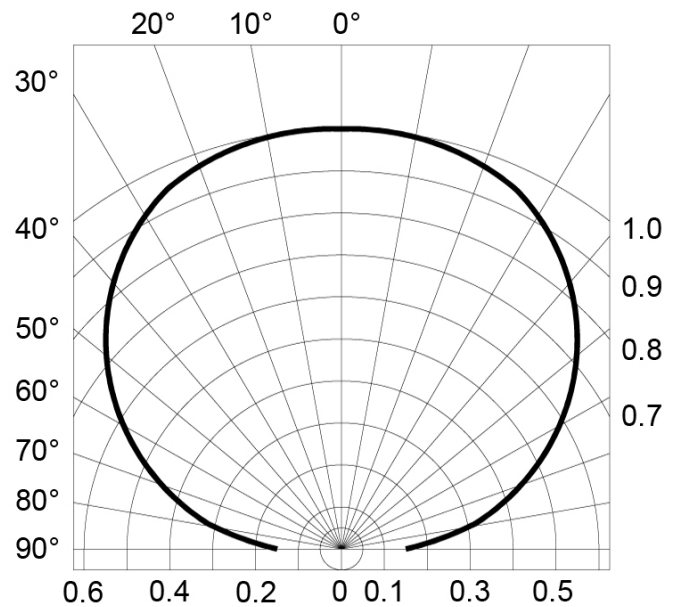

Fig. 5 Directivity Radiation Diagram

Bivar reserves the right to make changes at any time without notice.

# SURFACE MOUNT LED YELLOW/GREEN, 0605 PACKAGE



## Tape and Reel Dimensions

Note: 4000 pcs / Reel

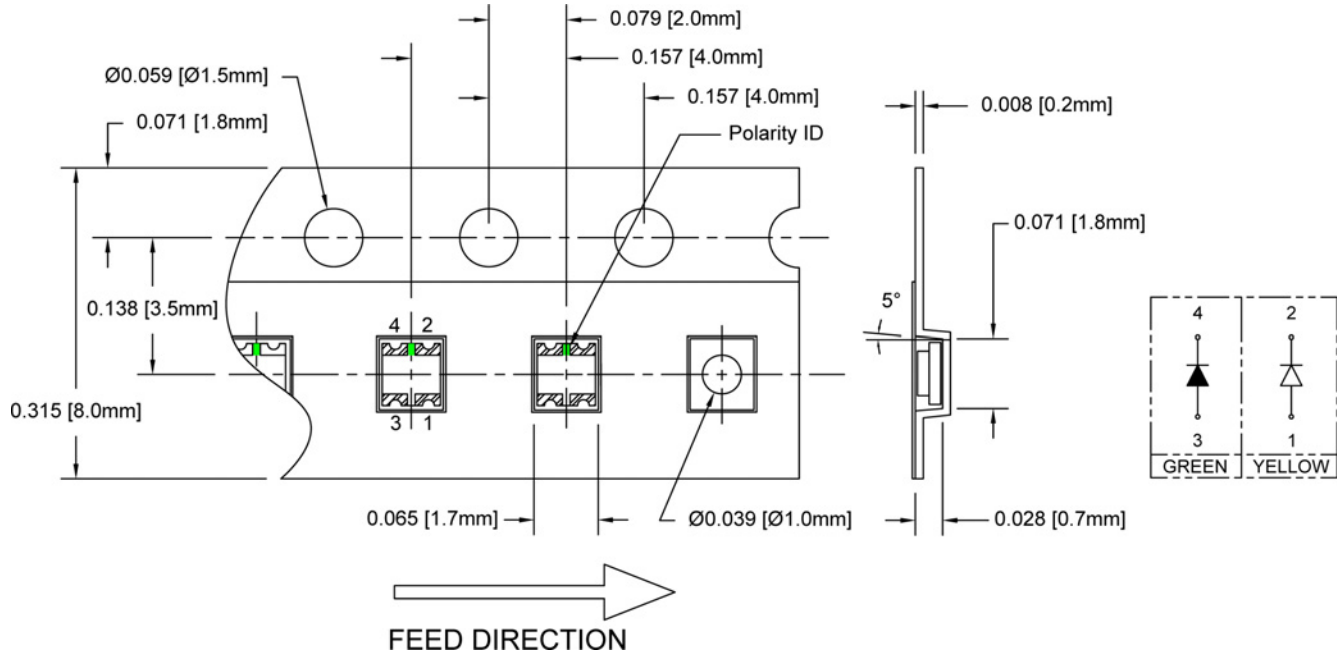

**Outline Drawings Notes:**

1. All dimensions are in inches [millimeters].
2. Standard tolerance:  $\pm 0.10''$  unless otherwise noted.

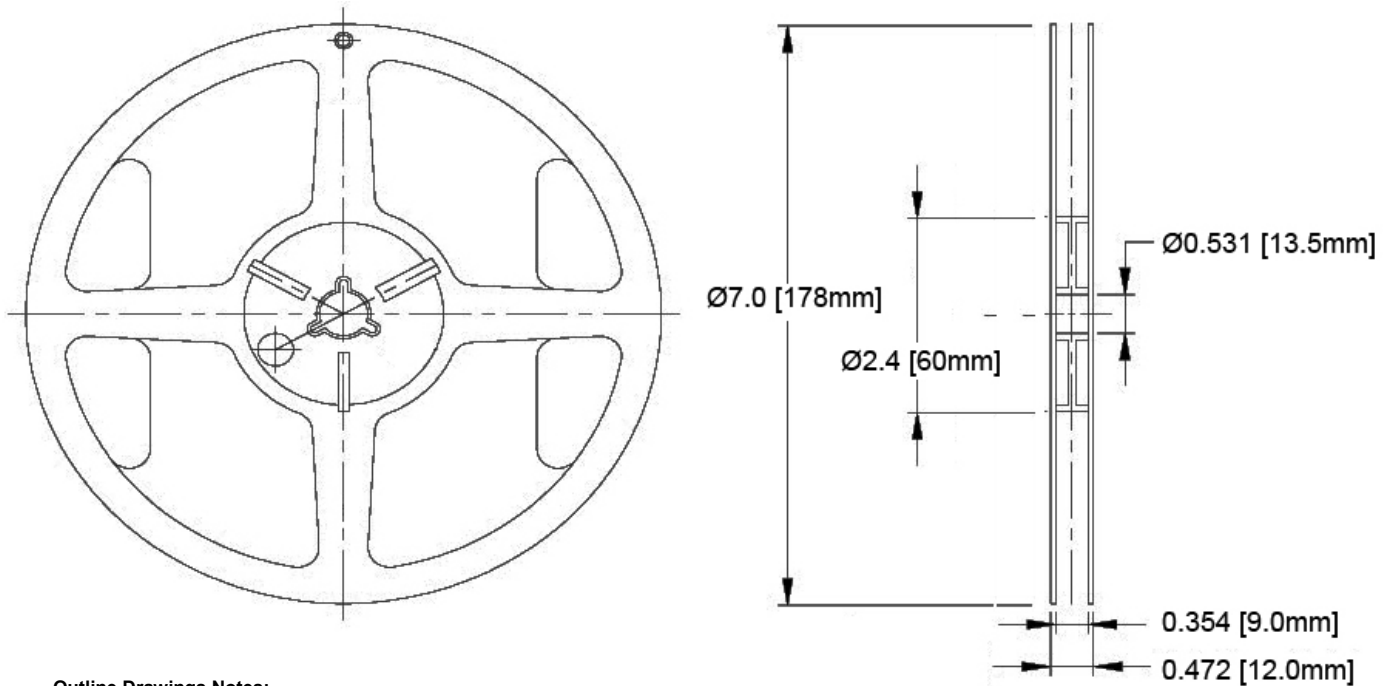

**Outline Drawings Notes:**

1. All dimensions are in inches [millimeters].
2. Standard tolerance:  $.xxx \pm 0.10''$ ,  $.x \pm 0.1''$  unless otherwise noted.

Bivar reserves the right to make changes at any time without notice.

# SURFACE MOUNT LED YELLOW/GREEN, 0605 PACKAGE



## Packaging and Labeling Plan

Note: 1 Reel / Bag

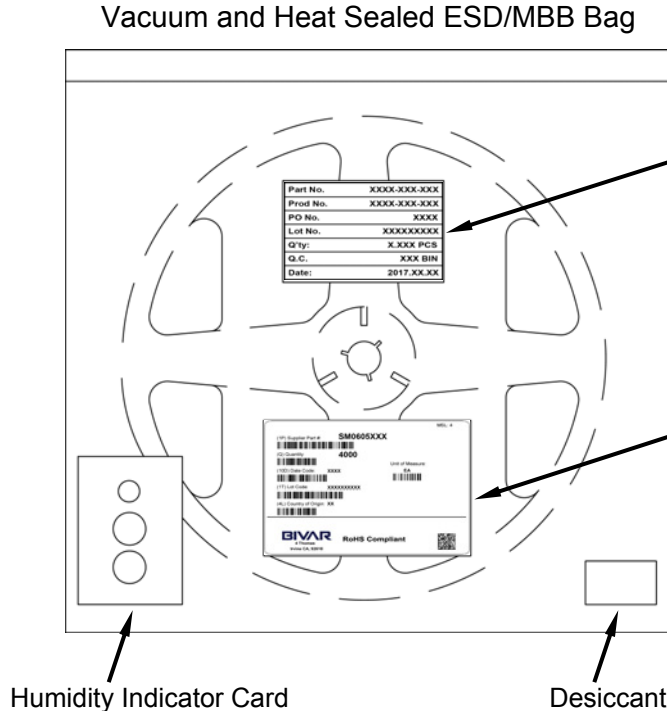

Part No.	XXXX-XXX-XXX
Prod No.	XXXX-XXX-XXX
PO No.	XXXX
Lot No.	XXXXXXXXXX
Q'ty:	X.XXX PCS
Q.C.	XXX BIN
Date:	2017.XX.XX

Internal Quality Control Label

MSL: 4

(1P) Supplier Part #: **SM0605XXX**

(Q) Quantity: **4000**

(10D) Date Code: **XXXX**

(1T) Lot Code: **XXXXXXXXXX**

(4L) Country of Origin: **XX**

Unit of Measure: **EA**

**BIVAR** RoHS Compliant

4 Thomas  
Irvine CA, 92618

Bivar Standard Packaging Label

## Recommended Soldering Conditions

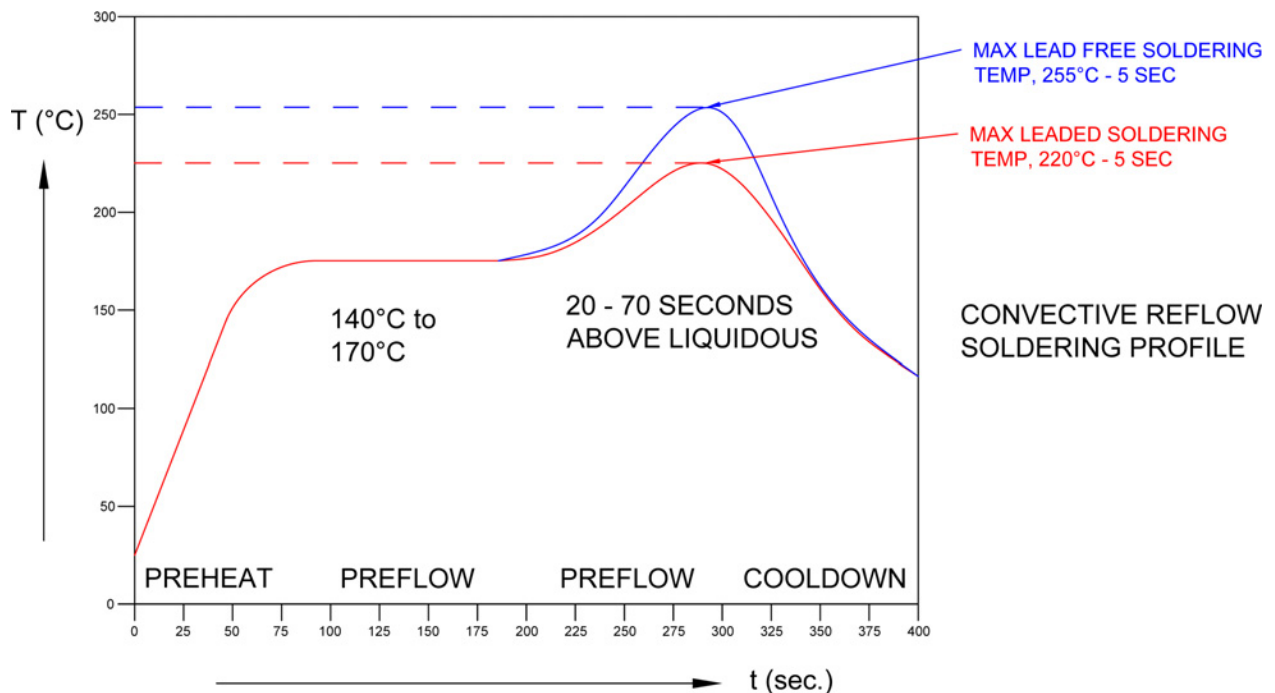

Bivar reserves the right to make changes at any time without notice.

## X-ON Electronics

Largest Supplier of Electrical and Electronic Components

*Click to view similar products for [Standard LEDs - SMD category](#):*

*Click to view products by [Bivar manufacturer](#):*

Other Similar products are found below :

[LTST-C19GD2WT](#) [LTST-N683GBEW](#) [LTW-170ZDC](#) [LTW-M140SZS40](#) [598-8110-100F](#) [598-8170-100F](#) [598-8610-202F](#) [67-22VRVGC/TR8](#) [AAAF5060QBFSEEZGS](#) [HLMP-6305-L0011](#) [ALMD-LB36-SV002](#) [APT1608QGW](#) [15-21UYC/S530-A3/TR8](#) [EASV1803BA0](#) [LS A676-P2S1-1](#) [SML310BATT86](#) [SML-512VWT86A](#) [SML-LX0606SISUGC/A](#) [SML-LXL1307SRC-TR](#) [SML-LXR851SIUPGUBC](#) [LT1ED53A](#) [FAT801-S](#) [AM27ZGC03](#) [APB3025SGNC](#) [APFA3010SURKCGKQBDC](#) [APHK1608VGCA](#) [APT2012QGW](#) [CLX6D-FKB-CN1R1H1BB7D3D3](#) [LTST-C250KGKT](#) [LTW-020ZDCG](#) [LTW-21TS5](#) [LTW-220DS5](#) [JANTXM19500/521-02](#) [UYGT801-S](#) [LO T67F-V1AB-24-1](#) [YGFR411-H](#) [SML-LX0402IC-TR](#) [CMDA20AYAA7D1S](#) [CMDA16AYDR7A1X](#) [339-1SURYGW/S530-A2](#) [598-8040-100F](#) [598-8070-100F](#) [598-8140-100F](#) [598-8610-200F](#) [EAPL3527GA5](#) [67-11/BHC-M1N2B8Y/2A0](#) [SML-LXL1209SYC/ATR](#) [EASV3020YGA0](#) [EAST16086YA5](#) [CMD91-21VRC/TR7](#)