

MODEL	SPECIFICATION	SP-01	Page
TE series Tact Switch			1/7
Subminiature Tact Switch-RoHS Compliant			

Order Information

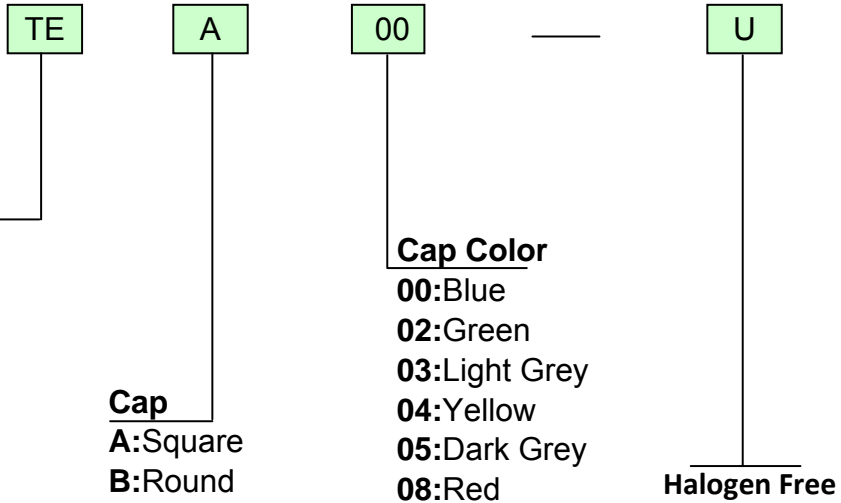

Subminiature Tact Switch

- TE0:** Thru-hole
- TES0:** SMD for under Foil
- TESM0:** SMD for with Cap
- TE1:** Thru-hole
- TES1:** SMD for under Foil
- TESM1:** SMD for with Cap
- TE1-R:** Right Angle

- Cap**
- A:** Square
 - B:** Round

- Cap Color**
- 00:** Blue
 - 02:** Green
 - 03:** Light Grey
 - 04:** Yellow
 - 05:** Dark Grey
 - 08:** Red

Halogen Free

Specifications

Contact Rating	24VDC, 20mA; Min. 0.5W
Contact Resistance	100mΩ
Insulation Resistance	1000mΩ at 100 VDC
Dielectric Strength	250VAC, 50Hz for the duration of 1 minute
Operation Temperature	-25 to +85
Mechanical Life	1,000,000 operations
Push Force	4N ± 1.0N
Travel	0.75 ± 0.25
Mounting	on pc-board
Wave Soldering	270 5 Sec. Max
Reflow Soldering	260 30 Sec. Max
Handing Soldering	350 3 Sec. Max

Materials:

Button :	Silicon , IVORY color
Base : TE1/TE1-R	Thermoplastic, meets (UL 94-HB), Blue, washable
TE0	Thermoplastic, meets (UL 94-HB), Red, washable
TES0/TESM0	Thermoplastic, meets (UL 94V-0), White, washable
TES1/TESM1	Thermoplastic, meets (UL 94V-0), Black, washable
Contact Disc :	Stainless steel , Silver Plated over Nickel barrier
Terminal Contact :	Brass, Gold-plated
Terminal :	Brass, Tin-plated
Bracket :	Brass, Tin-plated
Cap :	Thermoplastic, PC UL 94-V2

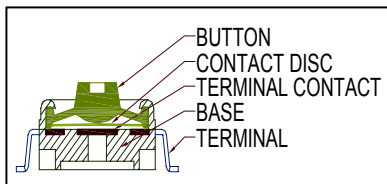

MODEL	<h1 style="text-align: center;">SPECIFICATION</h1>	SP-02	Page
TE series Tact Switch			Subminiature Tact Switch- RoHS Compliant

TE1

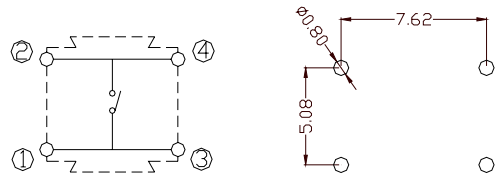
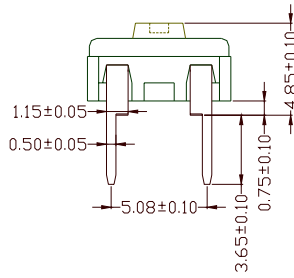
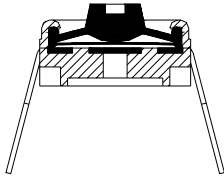
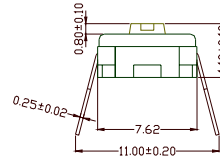
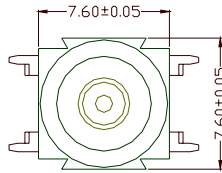

TES1 (SMD for Under Foil)

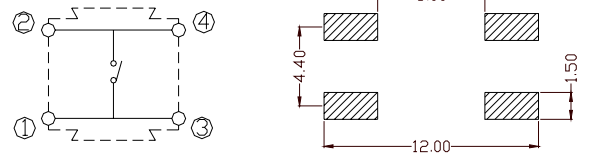
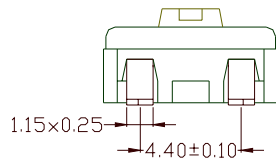
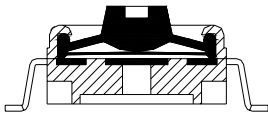
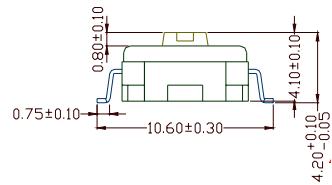
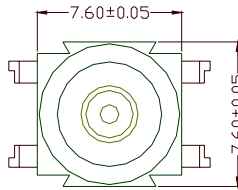

TESM1 (SMD for with Cap)

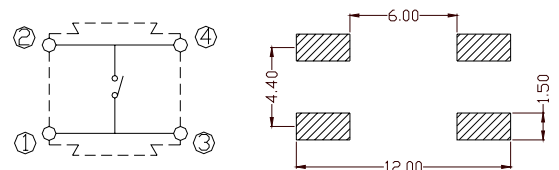
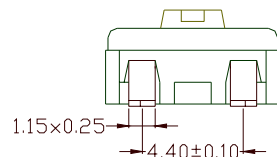
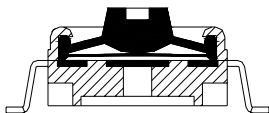
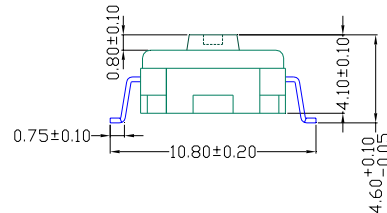
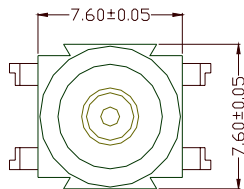

MODEL	SPECIFICATION	SP-03	Page
TE series Tact Switch			3/7

TE0

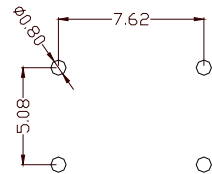
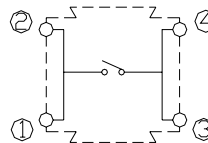
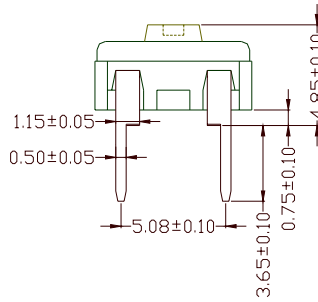
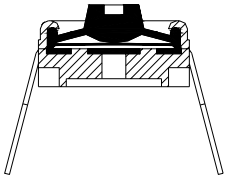
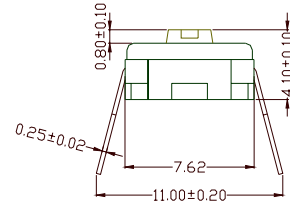
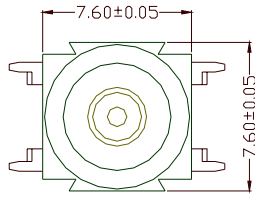

TES0

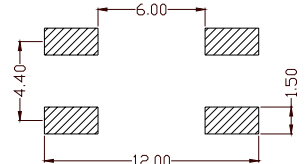
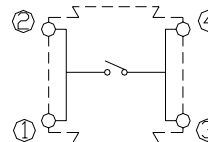
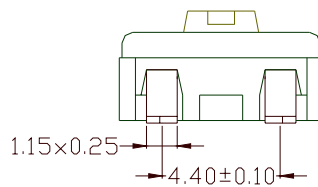
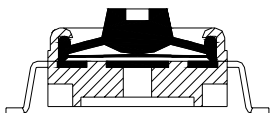
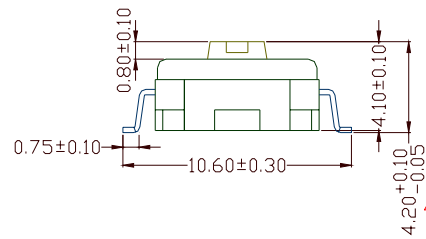
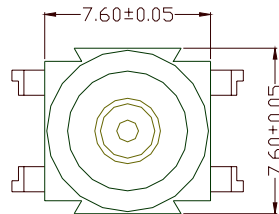
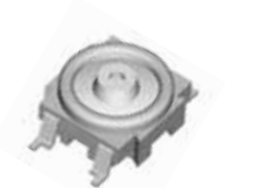

TESM0

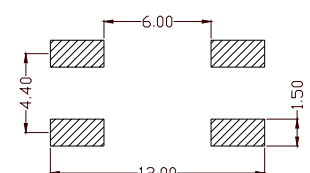
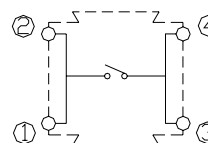
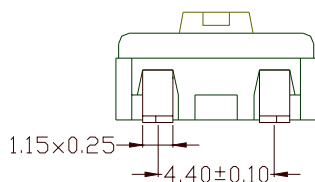
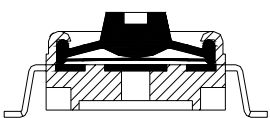
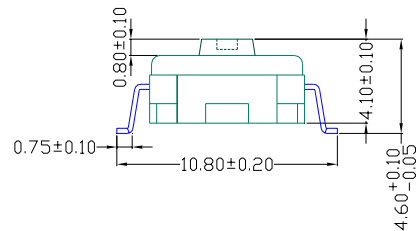
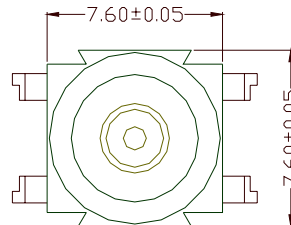

MODEL	SPECIFICATION	SP-04	Page
TE series Tact Switch			4/7
Subminiature Tact Switch-RoHS Compliant			

TE1-R

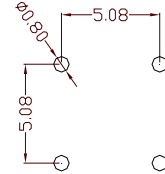
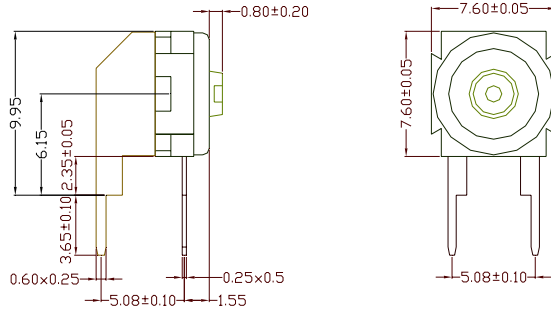
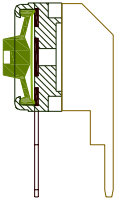
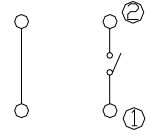
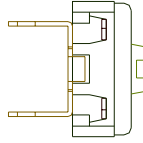

CAP

A: Square

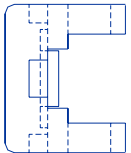
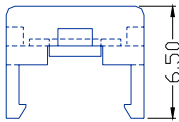
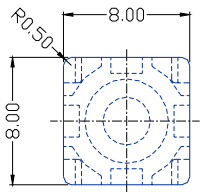

Material:PC	
P/N	Cap Color
A00	Blue
A02	Green
A03	Light Grey
A04	Yellow
A05	Dark Grey
A08	Red

B: Round

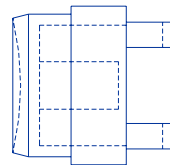
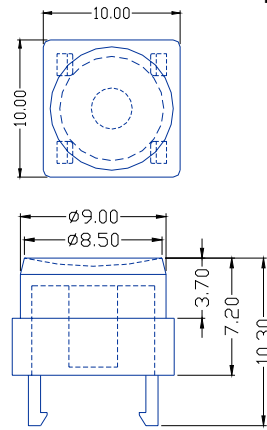

Material:PC	
P/N	Cap Color
B00	Blue
B02	Green
B03	Light Grey
B04	Yellow
B05	Dark Grey
B08	Red

Switch with Cap

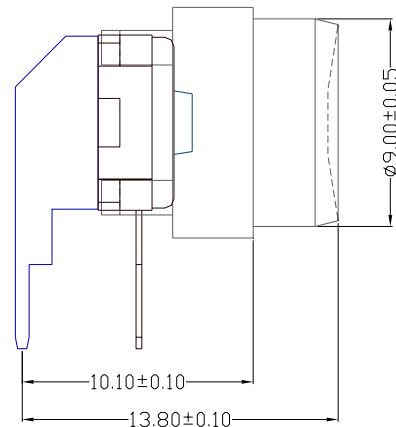
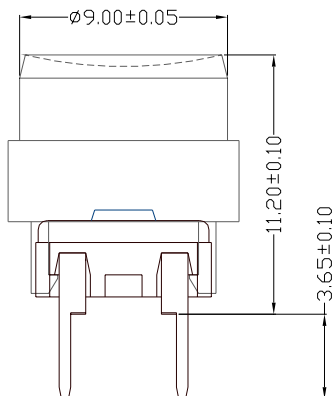

MODEL	SPECIFICATION	SP-05	Page
TE series Tact Switch			5/7
Subminiature Tact Switch-RoHS Compliant			

TE Typical system assembly with Plunger under overlay

Solder terminal for PCB.

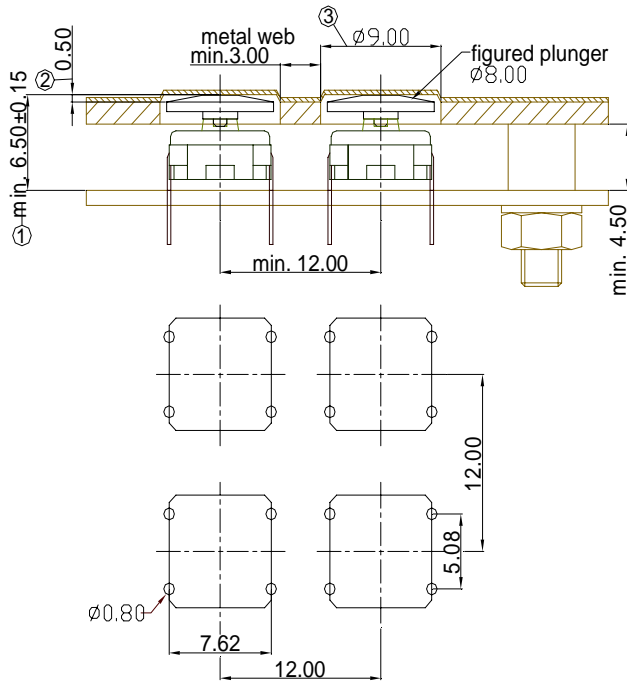

SMD gullwing terminal

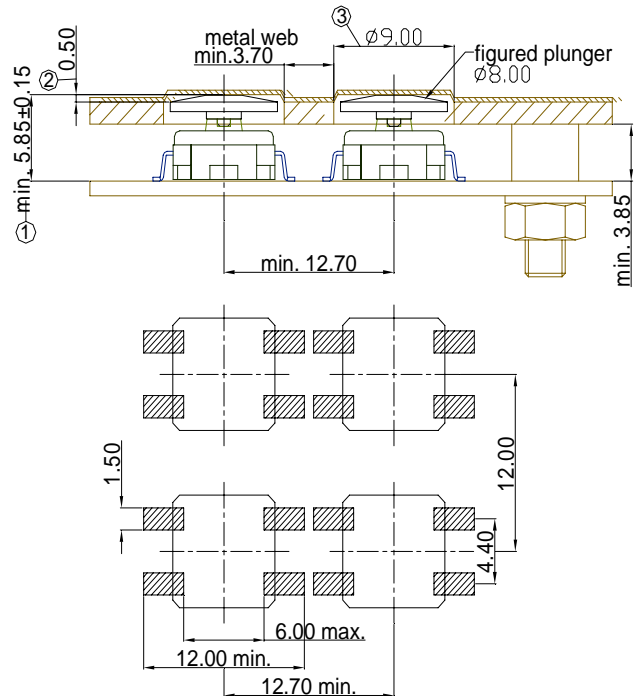

Explanation:

- 1 Overall height = TE + plunger
- 2 Recommended area embossing 0.35 mm at glue spacer thickness of 0.15 mm
- 3 Front panel cut out = plunger diameter + 1 mm

Classification Wave Soldering Profiles

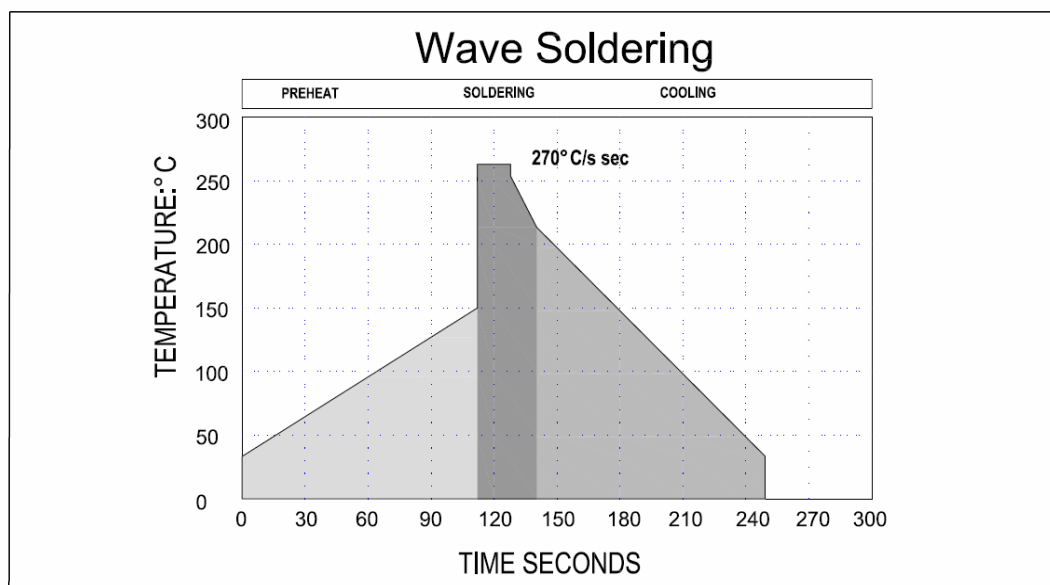

Maximum dwell time in the solder wave (270) shall not exceed 5 seconds.

Classification Reflow Profiles

Profile Feature	Pb-Free Assembly
Preheat / Soak	
Temperature Min (T_{Smin})	150
Temperature Max (T_{Smax})	200
Time(ts) from (T_{Smin} to T_{Smax})	60 ~120 seconds
Ramp-up Rate (T_L to T_p)	3 /second max
Liquidous temperature (T_L)	217
Time (t_L) maintained above to T_L	60 ~ 150 seconds
Peak package body temperature (T_p)	For users T_p must not exceed the Classification temp:260 (Package Thickness:>2.5mm) For suppliers T_p must equal or exceed the Classification temp:250 (Package Thickness:>2.5mm)
Time (t_p) within 5 of specified classification Temperature (T_c)	30 seconds
Ramp-Down Rate (T_p to T_L)	6 /second max
Time 25 to Peak Temperature	8 minutes max

* Tolerance for peak profile temperature(T_p) is defined as a supplier minimum and a user maximum

Note 1: All temperatures refer to topside of the package, measured on the package body surface.

Note 2: Time within 5 °C of actual peak temperature (t_p) specified for the reflow profiles is a “supplier” minimum and “user” maximum.

The table copy from IPC/JEDEC J-STD-020 D.1 Reflow Soldering Standard Conditions

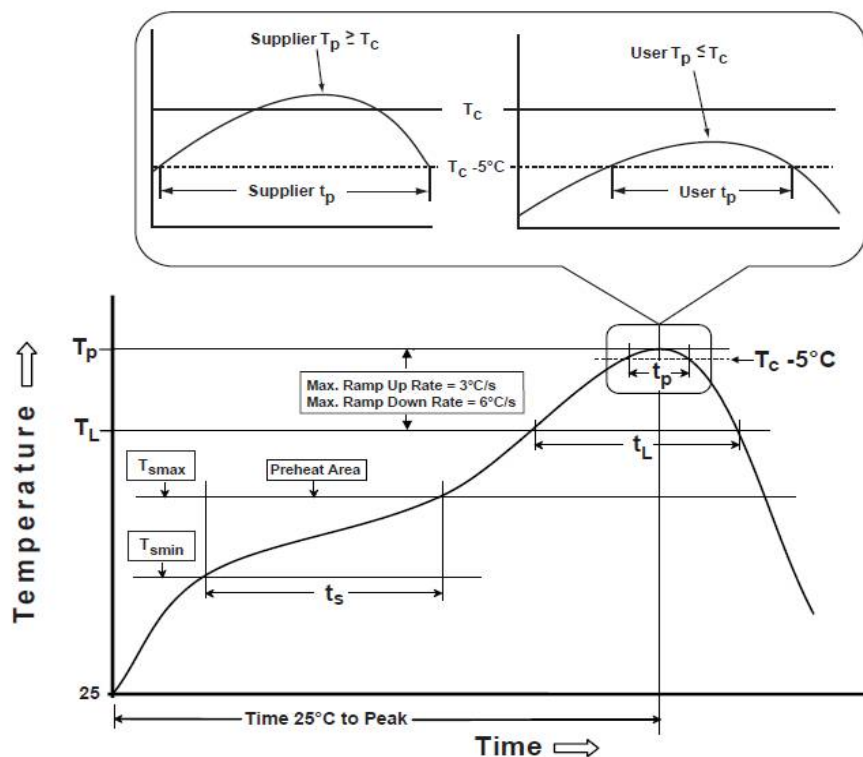

MODEL	SPECIFICATION	SP-08	Page
TE series Tact Switch			Subminiature Tact Switch-RoHS Compliant

Tube Package:

TE0/TE1/TE0/TESM0/TE1/TE0/TE1-R

(Tube = 400mm L)

P/N	TE0	TE1	TES0	TES1	TE1-R
TUBE	50	50	50	50	50
BOX	3200	3200	5000	5000	3300
CTN 1	6400	6400	10000	10000	6600
CTN 2	12800	12800	20000	20000	13200

TUBE

Thru-hole

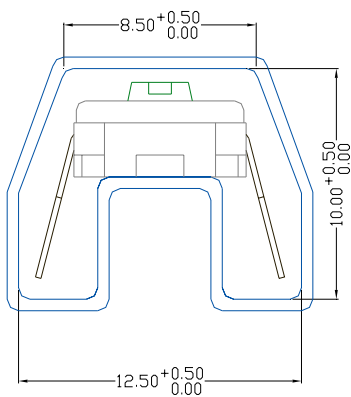

SMD

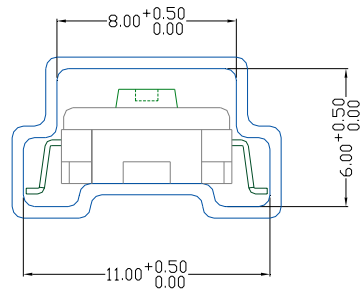

Right Angle

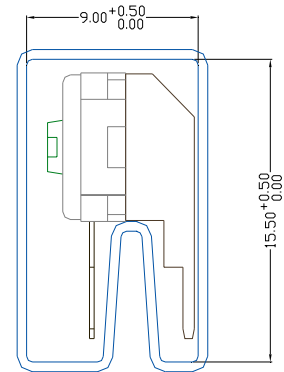

Tapin & Reel Package

TES0/TESM0/TE1/TE0/TE1-R
1200PCS/REEL

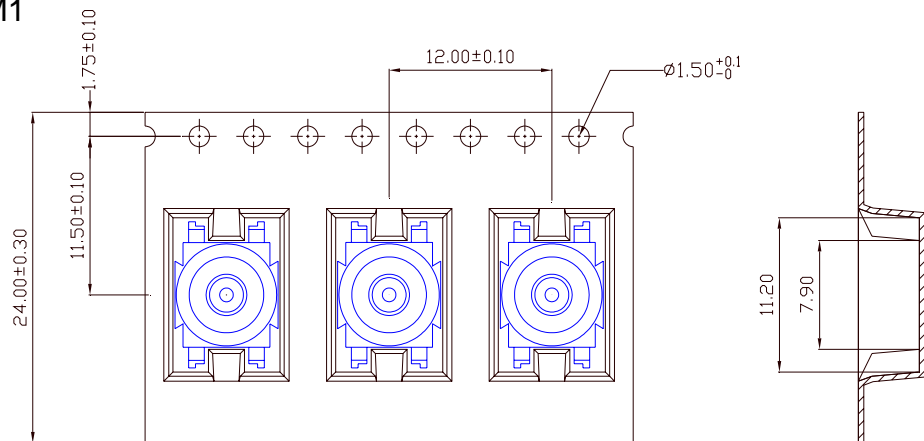

Box Dimension:

Tube57.0cm x 13.0cm x 12.5cm
 Reel34.0cm x 12.0cm x 33.0cm

Carton Dimension:

Tube
 CTN 1: 2 Boxes.....58.5cm x 29.0cm x 15.0cm
 CTN 2: 4 Boxes.....58.5cm x 28.0cm x 27.0cm
 Reel
 2 Boxes34.0cm x 26.0cm x 35.0cm

X-ON Electronics

Largest Supplier of Electrical and Electronic Components

Click to view similar products for [Tactile Switches](#) category:

Click to view products by [BIWIN](#) manufacturer:

Other Similar products are found below :

[6407-250V-25273P](#) [ADTSA62NV](#) [B3F-3123](#) [1977177-8](#) [1977266-1](#) [ADTSA63NV](#) [ADTSM21NSVTR](#) [ADTSM25RVTR](#) [ADTSM32NVTR](#)
[ADTSMW64RV](#) [1977120-6](#) [FSMRA4JHA04](#) [GS4.70F300QP](#) [KSC241J](#) [SP DELTA LFS](#) [3FTL600RAS](#) [3FTL640RAS](#) [Y96K132V0FPLFS](#)
[6407-250V-25343P](#) [ADTSM31NVTR](#) [2-1977120-7](#) [TSJW-5.2-260-TR](#) [Y651050400P](#) [KMT011MNGJLHS](#) [70-201.0](#) [ADTSG648NV](#)
[ADTSM62KSVTR](#) [ADTSM648NV](#) [95C06E3RAT](#) [3ATH9Q](#) [FSMRA8JHA04](#) [HARS0073](#) [Y33R411N9FPLFT](#) [Y33R51139FPLFT](#)
[Y31C01402FPLFS](#) [PTS645SK50SMTR92](#) [ADTSM32NVB](#) [KMS233GPWTLFG](#) [Y78B64124FP](#) [Y33A812C5FP LFT](#) [Y56B2D120FP LFS](#)
[PTS645 DVM83-BN125-2 LFS](#) [B3W 1000G](#) [B3F 1002C](#) [B3F 0047H](#) [B3W 1002C](#) [B3F 5001G](#) [B3W 1100C](#) [1-1571563-4](#) [B3F 3150M](#)
[KT11P4SA1M35 LFG SS-FORM](#)