



TECHNICAL SPECIFICATION

maximum switching voltage	100 V
maximum switching current	100 mA
sensor / magnet dimensions	32 x 15 x 8 mm
mounting holes diameter	3,5 mm
mounting holes spacing	20 mm
magnet - sensor detection gap	up to 15mm
cable length	250 mm
enclosure	aluminium



CONNECTION DIAGRAM

Connecting reed switches to the doorBox:

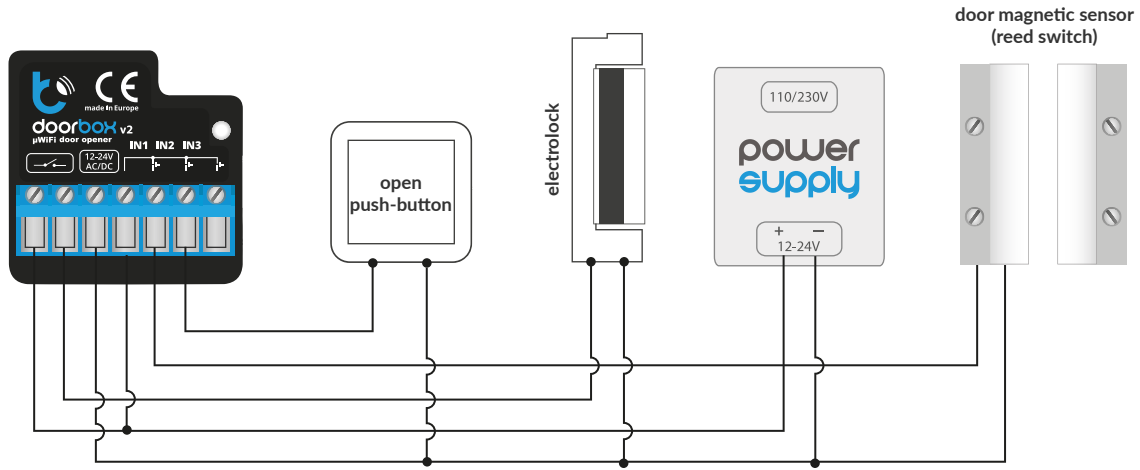

Connecting the reed switches to the gateBox:

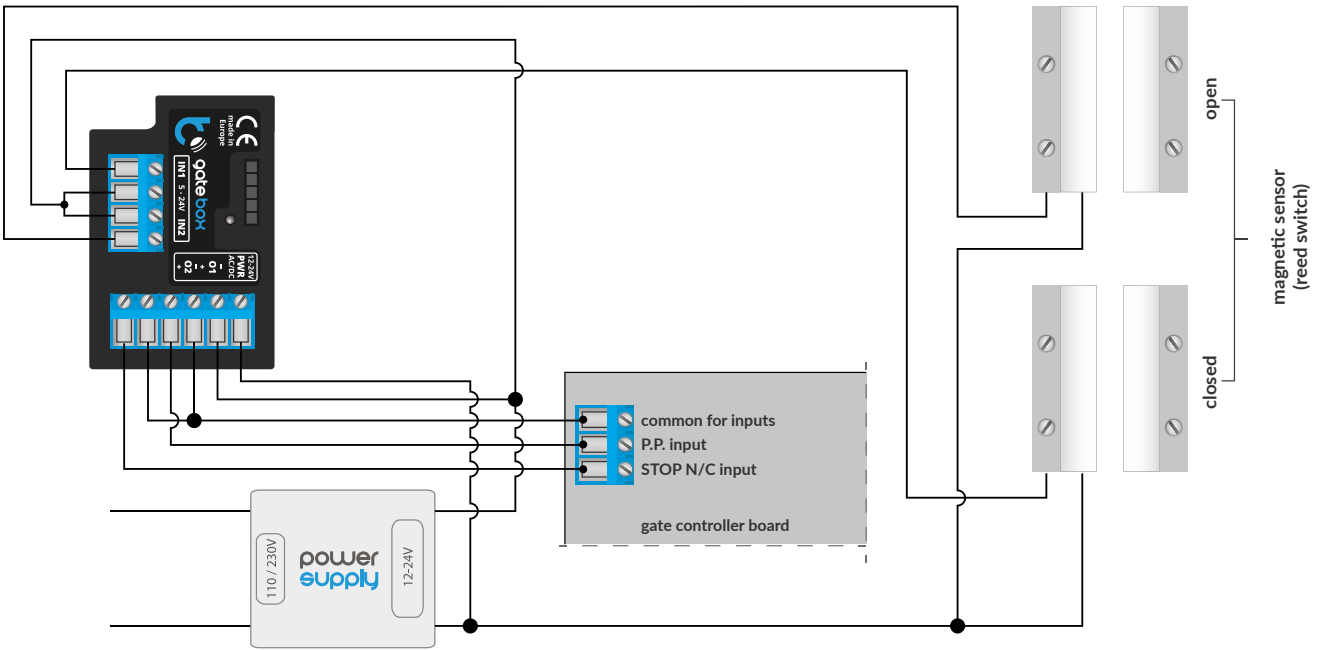

Connecting the reed switches to the switchBoxDC:

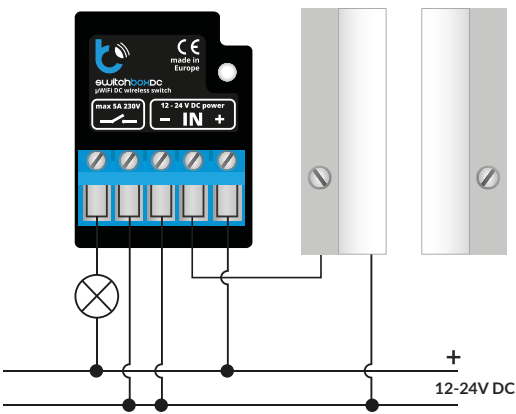

Connecting the reed switches to the switchBoxDC:

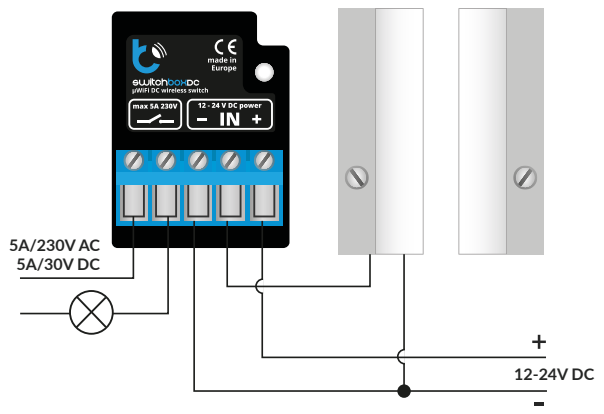

CONNECTION DIAGRAM

Connection example of reed switch for sectional doors:

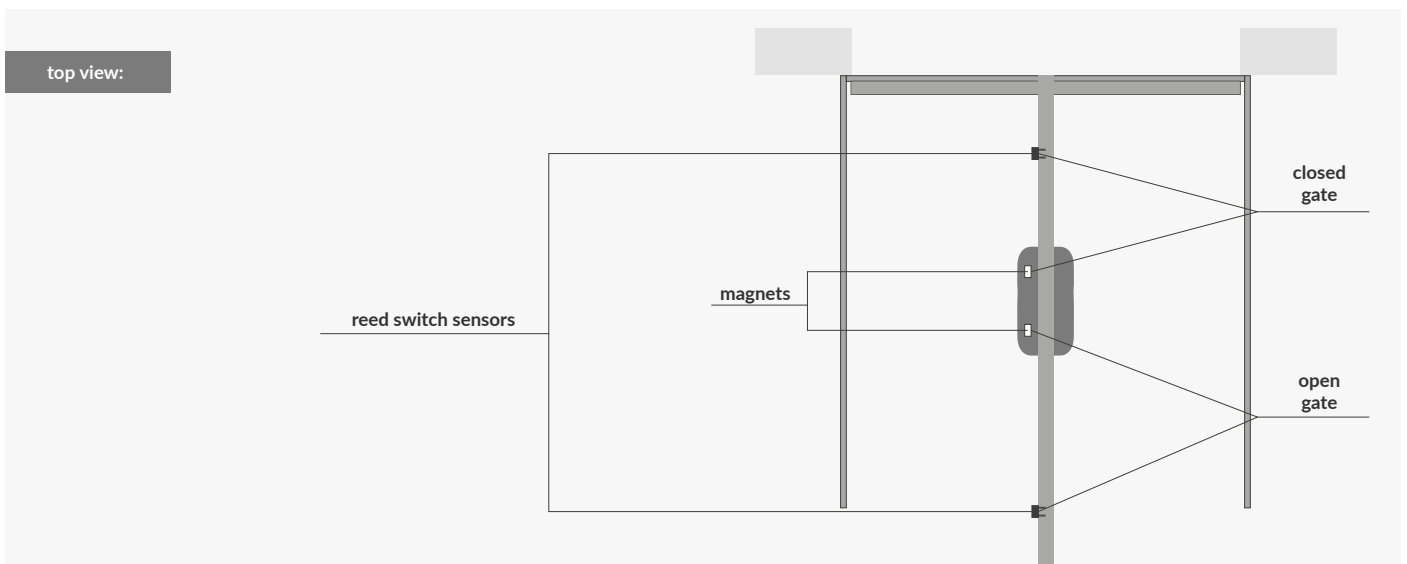
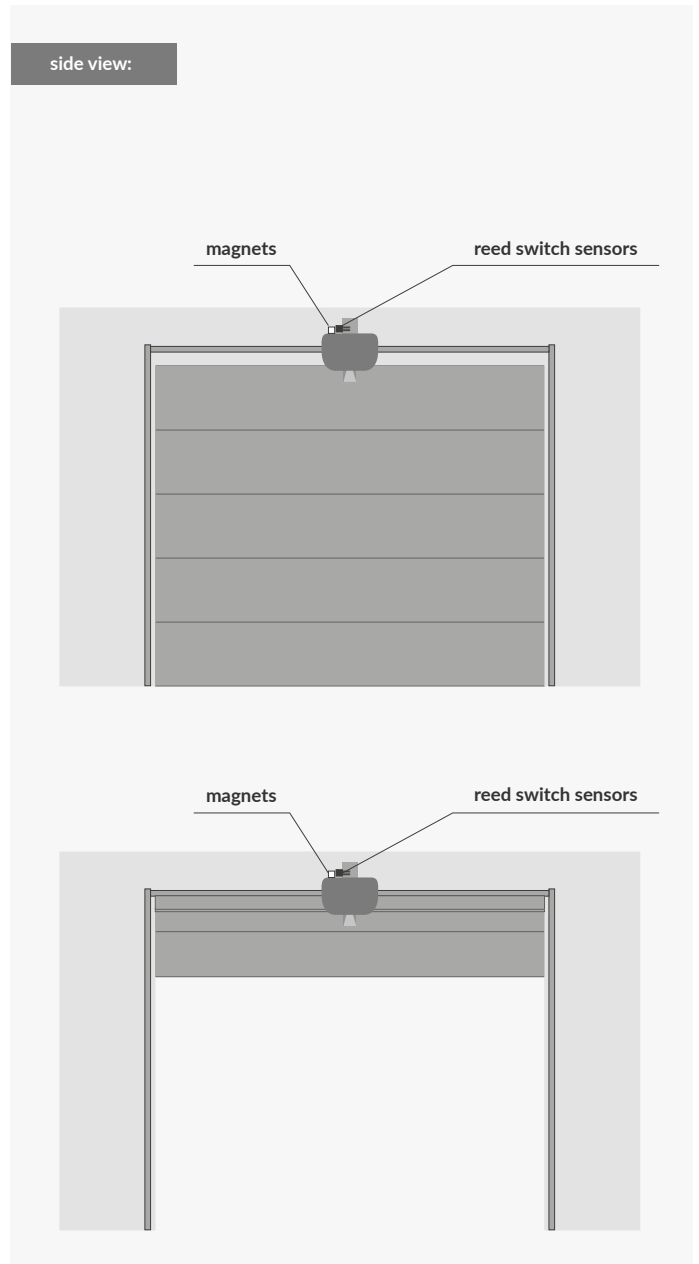
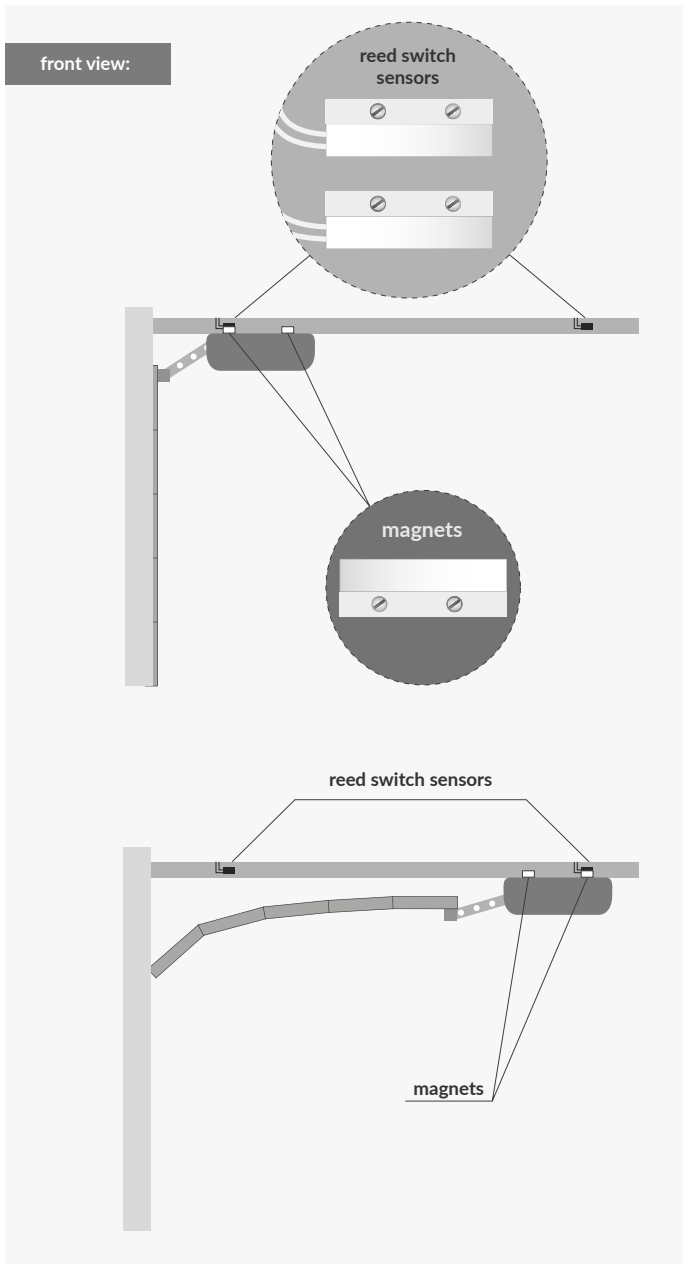

CONNECTION DIAGRAM

Connection example of reed switch for sliding gate:

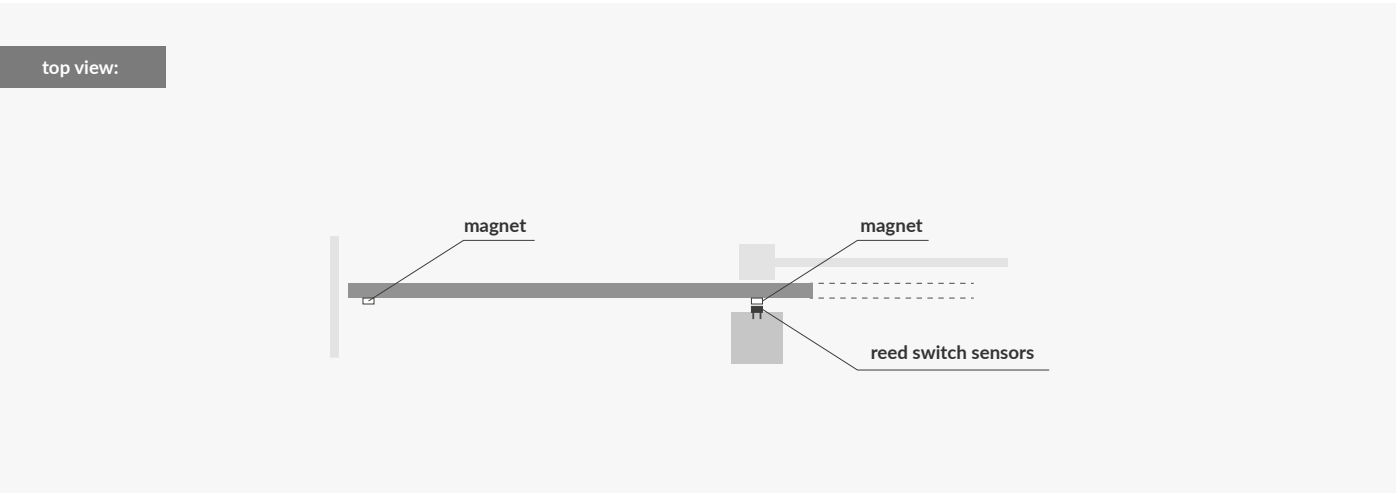
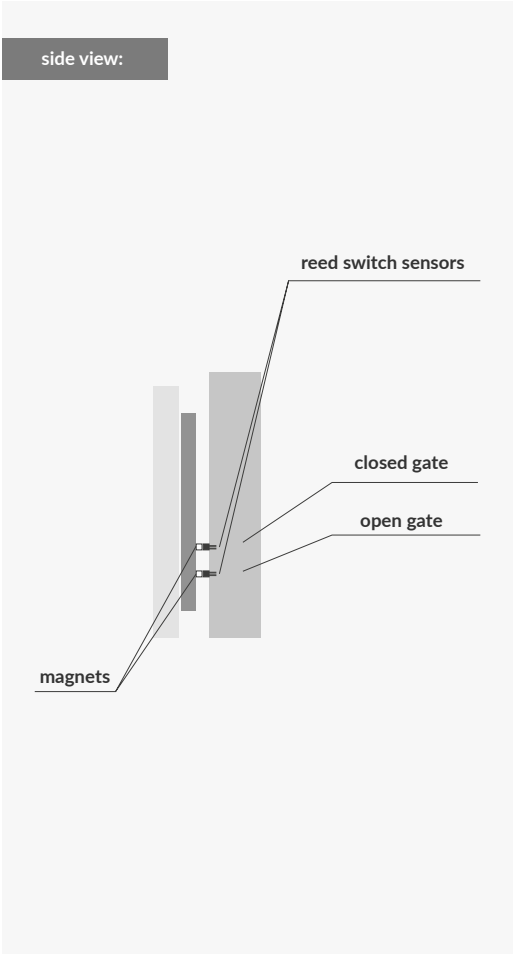
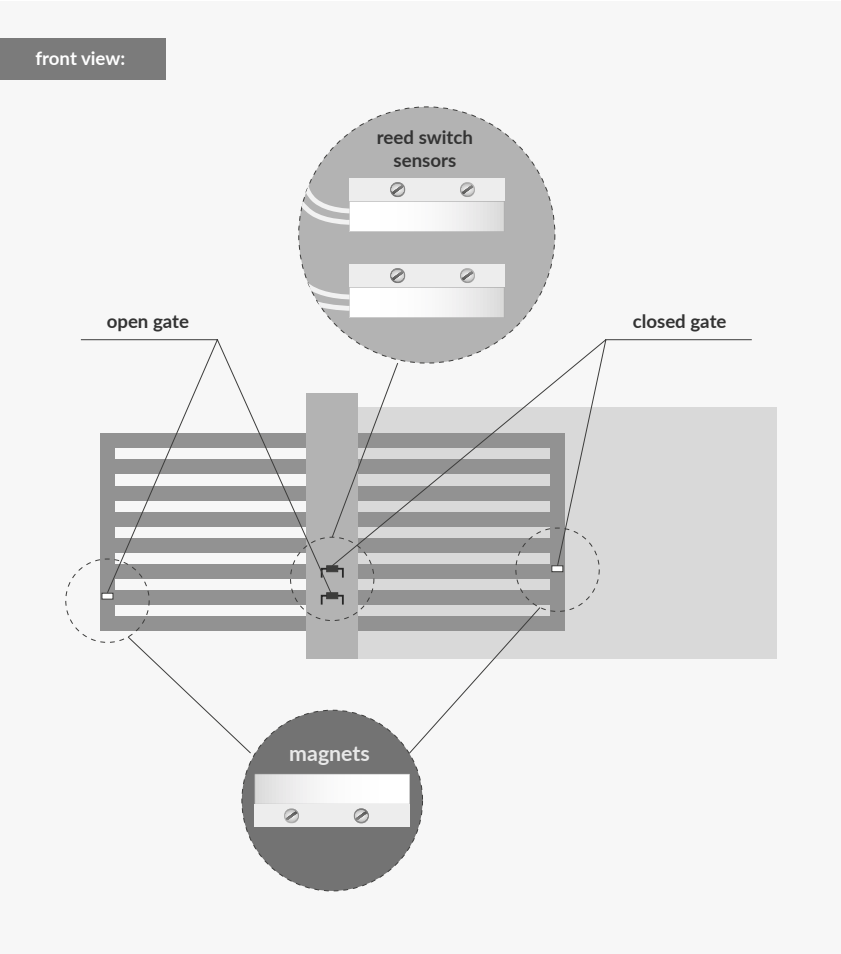

X-ON Electronics

Largest Supplier of Electrical and Electronic Components

Click to view similar products for [Specialist Controllers](#) category:

Click to view products by [BLEBOX](#) manufacturer:

Other Similar products are found below :

[CV500SLK21](#) [H2CRSAC110B](#) [R88ARR080100S](#) [E53E01](#) [E53E8C](#) [E5GNQ03PFLKACDC24](#) [B300LKL21](#) [NSCXDC1V3](#)
[NT20SST122BV1](#) [C40PEDRA](#) [K31S5](#) [K31S6](#) [K3TX-AD31A](#) [L595020](#) [26546803](#) [26546805](#) [H7HP-C8D](#) [PWRA440A](#) [CPM1AETL03CH](#)
[3G2A5BI081](#) [3G2A5IA122](#) [3G2A5OD211](#) [3G2A5RM001EV1](#) [3G2A5RT002EV1](#) [3G2A6-ID217](#) [3G2A6LK202EV1](#) [3G2A9AL004E](#)
[C200HETL01E](#) [C200PCPD024](#) [3G2A5AD001](#) [3G2A5BI051](#) [3G2A5IA121](#) [3G2A5ID112](#) [3G2A5ID213](#) [3G2A5ID219](#) [3G2A5MR431](#)
[3G2A5OC221](#) [3G2A5PS222E](#) [3G2A6IM213](#) [3G2A6-OD412](#) [3G2A9AL001](#) [3G2C7LK202EV1](#) [3G5A2OC221E](#) [LDP2TA2B115](#)
[3G3DV130B4294](#) [E53E04](#) [E53Q4Q4](#) [E54E8CT](#) [C200HWCOM06EV1](#) [NT30KBA04](#)