

Short circuit proof PCB transformer AVB

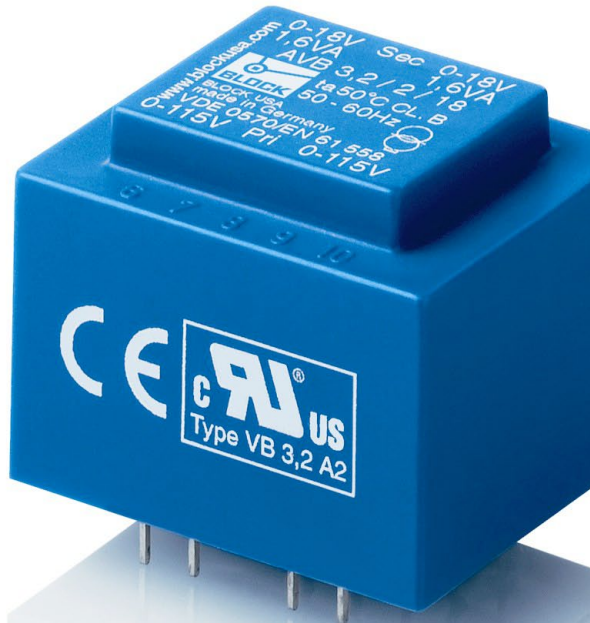

General Data

Rated input voltage 2 x 115 Vac
Rated output voltage 6 - 2 x 24 Vac
Rated power 0.35 - 3.2 VA
Insulation class B
Maximum ambient temperature 70 °C (AVB 3,2 max. 50 °C)
Efficiency up to 59 %
Degree of protection IP 00

Advantages

Minimum size at high output
Unconditionally short-circuit proof
Double input voltage for series or parallel connection
Also with double output voltage for series or parallel connection
Designed for high ambient temperatures
Permanent corrosion protection, high insulation value and maximum electrical reliability thanks to XtraDenseFill resin encapsulation
Coil shell in 2-chamber technology
Self-extinguishing potting and hood material

Applications

As a mains transformer for adjustment of the voltage and simple electrical isolation.

As a safety transformer for the safe electrical isolation of the input and output sides. The transformer is suitable for creating SELV and PELV circuits because of the limit on the output voltage.

Sample application

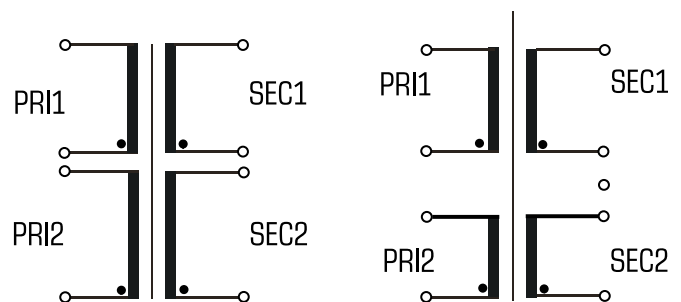

Standards



Mains transformer
to: VDE 0570 Teil 2-1, DIN EN 61558-2-1, EN 61558-2-1, IEC 61558-2-1, UL 5085-1/-2, CSA 22.2 No.66

Safety isolating transformer
to: VDE 0570 Teil 2-6, DIN EN 61558-2-6, EN 61558-2-6, IEC 61558-2-6, UL 5085-1/-2, CSA 22.2 No.66

Approvals



UL 5085-1/-2, CSA 22.2 No.66

1.1

1.2

1.3

2.1

2.2

3.1

3.2

3.3

4.0

5.1

5.2

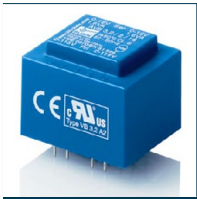

Short circuit proof PCB transformer

AVB



Typ	AVB 0,35/2/..	AVB 0,5/2/..	AVB 1,0/2/..	AVB 1,5/2/..	AVB 2,0/2/..	AVB 2,3/2/..
Electrical data						
Input						
Rated input voltage	2 x 115 Vac	2 x 115 Vac	2 x 115 Vac	2 x 115 Vac	2 x 115 Vac	2 x 115 Vac
Rated frequency	50 - 60 Hz	50 - 60 Hz	50 - 60 Hz	50 - 60 Hz	50 - 60 Hz	50 - 60 Hz
Output						
Rated output voltage: Order no.	2x6 Vac: AVB 0,35/2/6 2x9 Vac: AVB 0,35/2/9 2x12 Vac: AVB 0,35/2/12 2x18 Vac: AVB 0,35/2/18* 2x24 Vac: AVB 0,35/2/24*	2x6 Vac: AVB 0,5/2/6 2x8 Vac: AVB 0,5/2/8 2x9 Vac: AVB 0,5/2/9 2x12 Vac: AVB 0,5/2/12 2x15 Vac: AVB 0,5/2/15* 2x18 Vac: AVB 0,5/2/18* 2x24 Vac: AVB 0,5/2/24*	2x6 Vac: AVB 1,0/2/6 2x9 Vac: AVB 1,0/2/9 2x12 Vac: AVB 1,0/2/12 2x15 Vac: AVB 1,0/2/15 2x18 Vac: AVB 1,0/2/18* 2x24 Vac: AVB 1,0/2/24*	2x6 Vac: AVB 1,5/2/6 2x8 Vac: AVB 1,5/2/8 2x9 Vac: AVB 1,5/2/9 2x12 Vac: AVB 1,5/2/12 2x15 Vac: AVB 1,5/2/15 2x18 Vac: AVB 1,5/2/18* 2x24 Vac: AVB 1,5/2/24*	2x12 Vac: AVB 2,0/2/12	2x6 Vac: AVB 2,3/2/6 2x9 Vac: AVB 2,3/2/9 2x12 Vac: AVB 2,3/2/12 2x15 Vac: AVB 2,3/2/15 2x18 Vac: AVB 2,3/2/18* 2x24 Vac: AVB 2,3/2/24*
Rated Power	0.35 VA	0.50 VA	1.00 VA	1.50 VA	2.00 VA	2.30 VA
No-load voltage (app. x factor)	1.80	1.80	1.32	1.39	1.43	1.43
No-load loss (typ.)	1.30 W	1.10 W	0.90 W	1.00 W	0.90 W	0.90 W
Efficiency	30 %	40 %	55 %	57 %	43 %	59 %
Standards						
Classification	Safety isolating transformer *Mains transformer	Safety isolating transformer *Mains transformer	Safety isolating transformer *Mains transformer	Safety isolating transformer *Mains transformer	Safety isolating transformer	Safety isolating transformer *Mains transformer
Approvals						
Approvals	cURus	cURus	cURus	cURus	cURus	cURus
Environment						
Ambient temperature max.	70 °C	70 °C	70 °C	70 °C	70 °C	70 °C
Safety and protection						
Type	Encapsulated	Encapsulated	Encapsulated	Encapsulated	Encapsulated	Encapsulated
Class of Insulation System	VDE=B, UL=class 105	VDE=B, UL=class 105	VDE=B, UL=class 105	VDE=B, UL=class 105	VDE=B, UL=class 105	VDE=B, UL=class 105
Protection index	IP 00	IP 00	IP 00	IP 00	IP 00	IP 00
Safety class (prepared)	II	II	II	II	II	II
Short circuit strength	inherently short-circuit proof	inherently short-circuit proof	inherently short-circuit proof	inherently short-circuit proof	inherently short-circuit proof	inherently short-circuit proof
Order numbers						
Order Number	see rated output voltage	see rated output voltage	see rated output voltage	see rated output voltage	see rated output voltage	see rated output voltage

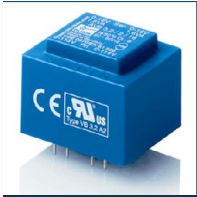

Short circuit proof PCB transformer **AVB**



Typ	AVB 2,3/2/..	AVB 3,2/2/..
Electrical data		
Input		
Rated input voltage	2 x 115 Vac	2 x 115 Vac
Rated frequency	50 - 60 Hz	50 - 60 Hz
Output		
Rated output voltage: Order no.	2x8 Vac: AVB 2,3/2/8	2x6 Vac: AVB 3,2/2/6 2x9 Vac: AVB 3,2/2/9 2x12 Vac: AVB 3,2/2/12 2x15 Vac: AVB 3,2/2/15 2x18 Vac: AVB 3,2/2/18 2x24 Vac: AVB 3,2/2/24*
Rated Power	2.30 VA	3.20 VA
No-load voltage (app. x factor)	1.43	1.57
No-load loss (typ.)	0.90 W	1.00 W
Efficiency	59 %	58 %
Standards		
Classification	Safety isolating transformer	Safety isolating transformer *Mains transformer
Approvals		
Approvals	cURus	cURus
Environment		
Ambient temperature max.	70 °C	50 °C
Safety and protection		
Type	Encapsulated	Encapsulated
Class of Insulation System	VDE=B, UL=class 105	VDE=B, UL=class 105
Protection index	IP 00	IP 00
Safety class (prepared)	II	II
Short circuit strength	inherently short-circuit proof	inherently short-circuit proof
Order numbers		
Order Number	see rated output voltage	see rated output voltage

1.1

1.2

1.3

2.1

2.2

3.1

3.2

3.3

4.0

5.1

5.2

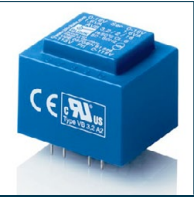

Short circuit proof PCB transformer **AVB**



Mechanical data	Typ	Terminals	Pin (ø)	Core type	Weight	Dimension picture (in mm)	A	B	C	D	E	F	G	H
	AVB 0,35/2/..	Pins for printed circuit boards	0.6	EE 20/6,1	0.02 kg	1	22	22.7	15	15	15	5	-	5
	AVB 0,5/2/..	Pins for printed circuit boards	0.6	EE 20/10,5	0.04 kg	1	22	22.7	19	15	15	5	-	5
	AVB 1,0/2/..	Pins for printed circuit boards	0.8	EI 30/10,5	0.07 kg	2	32.3	27.3	21.8	20	20	10	5	5
	AVB 1,5/2/..	Pins for printed circuit boards	0.8	EI 30/12,5	0.08 kg	2	32.3	27.3	23.8	20	20	10	5	5
	AVB 2,0/2/..	Pins for printed circuit boards	0.8	EI 30/15,5	0.10 kg	2	32.3	27.3	26.8	20	20	10	5	5
	AVB 2,3/2/..	Pins for printed circuit boards	0.8	EI 30/18	0.11 kg	2	32.3	27.3	29	20	20	10	5	5
	AVB 2,3/2/..	Pins for printed circuit boards	0.8	EI 30/18	0.11 kg	2	32.3	27.3	39	20	20	10	5	5
	AVB 3,2/2/..	Quick connect terminals	0.6 x 0.8	EI 38/16,5	0.17 kg	3	41	35	30.8	20	25	10	5	5

Dimension pictures

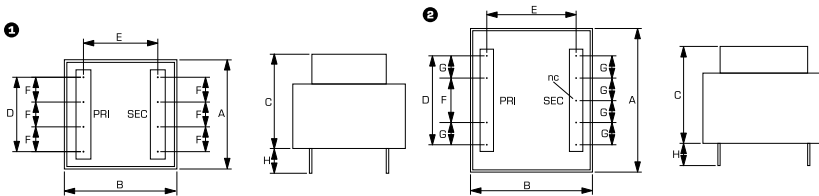

X-ON Electronics

Largest Supplier of Electrical and Electronic Components

Click to view similar products for [block manufacturer](#):

Other Similar products are found below :

[PVSB 400/24-20](#) [RKD 120/2X24](#) [AIM5.0/2.5](#) [VB1.5/2/24](#) [STEU160/48](#) [TIM300](#) [AVB1.0/2/12](#) [FL4/18](#) [AVB2.3/2/12](#) [FL10/15](#) [FL6/24](#)
[FL24/6](#) [STEU320/23](#) [STEU160/23](#) [LR3 48-3/80](#) [LR3 48-5/16](#) [PC-0148-100-0](#) [PM-0112-040-0](#) [PM-0748-400-0](#) [PT 7.5/2/9](#) [FL14/6](#) [FL52/12](#)
[GNC24-2.5](#) [DCT24-1.5](#) [VB2.3/2/9](#) [VB 1.5/2/8](#) [SIM100](#) [RKD 100/2X15](#) [LR3 48-5/80](#) [LR3 48-5/90](#) [PM-0112-070-0](#) [PM-0148-020-0](#) [EB-](#)
[1824-010-0](#) [USTE1000/2X115](#) [FL14/18](#) [FL6/6](#) [VB 0.35/1/15](#) [PC-0324-400-0](#) [STEU250/23](#) [AIM3.2/1.6](#) [AVB3.2/2/12](#) [FL10/12](#) [FL14/15](#)
[FL8/6](#) [FL8/9](#) [LR3 48-3/90](#) [PC-0112-150-0](#) [EB-2724-100-0](#) [PVAF 24/3,2AH](#) [PT 4.5/2/12](#)