

### 描述 / Descriptions

TO-126 塑封封装 PNP 半导体三极管。Silicon PNP transistor in a TO-126 Plastic Package.

### 特征 / Features

与 2SD669(A)互补。

Complementary pair with 2SD669(A).

### 用途 / Applications

用于低频功率放大。

Low frequency power amplifier.

### 内部等效电路 / Equivalent Circuit

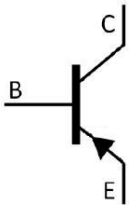

### 引脚排列 / Pinning

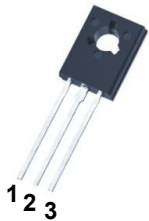

PIN1 : Emitter

PIN 2 : Collector

PIN 3 : Base

### 放大及印章代码 / $h_{FE}$ Classifications & Marking

$h_{FE}$ Classifications Symbol	B	C	D
$h_{FE}$ Range	60~120	100~200	160~320

**极限参数 / Absolute Maximum Ratings(Ta=25°C)**

参数 Parameter	符号 Symbol	数值 Rating	单位 Unit
Collector to Base Voltage	$V_{CBO}$	-180	V
Collector to Emitter Voltage	$V_{CEO}$	2SB649	-120
		2SB649A	-160
Emitter to Base Voltage	$V_{EBO}$	-5.0	V
Collector Current - Continuous	$I_C$	-1.5	A
Peak Collector Current	$I_{CP}$	-3.0	A
Collector Power Dissipation	$P_C$	1.0	W
Collector Power Dissipation	$P_C(T_C=25^\circ\text{C})$	20	W
Junction Temperature	$T_j$	150	°C
Storage Temperature Range	$T_{stg}$	-55~150	°C

**电性能参数 / Electrical Characteristics(Ta=25°C)**

参数 Parameter	符号 Symbol	测试条件 Test Conditions	最小值 Min	典型值 Typ	最大值 Max	单位 Unit
Collector to Base Breakdown Voltage	$V_{CBO}$	$I_C=-1.0\text{mA}$ $I_E=0$	-180			V
Collector to Emitter Breakdown Voltage	$V_{CEO}$	2SB649	-120			V
		2SB649A	-160			
Emitter to Base Breakdown Voltage	$V_{EBO}$	$I_E=-1.0\text{mA}$ $I_C=0$	-5.0			V
Collector Cut-Off Current	$I_{CBO}$	$V_{CB}=-160\text{V}$ $I_E=0$			-10	μA
DC Current Gain	$h_{FE(1)}$	$V_{CE}=-5.0\text{V}$ $I_C=-150\text{mA}$	60		320	
	$h_{FE(2)}$	$V_{CE}=-5.0\text{V}$ $I_C=-500\text{mA}$	30			
Collector to Emitter Saturation Voltage	$V_{CE(sat)}$	$I_C=-500\text{mA}$ $I_B=-50\text{mA}$			-1.0	V
Base to Emitter Saturation Voltage	$V_{BE(sat)}$	$V_{CE}=-5.0\text{V}$ $I_C=-150\text{mA}$			-1.5	V
Transition Frequency	$f_T$	$V_{CE}=-5.0\text{V}$ $I_C=-150\text{mA}$		140		MHz
Collector Output Capacitance	$C_{ob}$	$V_{CB}=-10\text{V}$ $I_E=0$ $f=1.0\text{MHz}$		27		pF

**电参数曲线图 / Electrical Characteristic Curve**

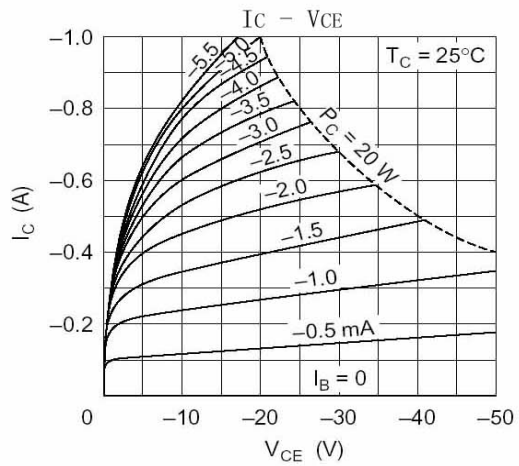
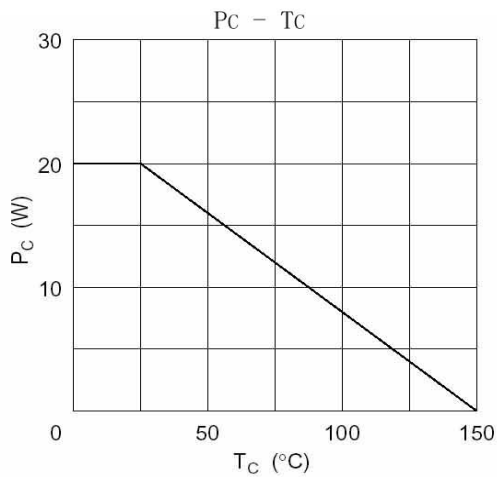
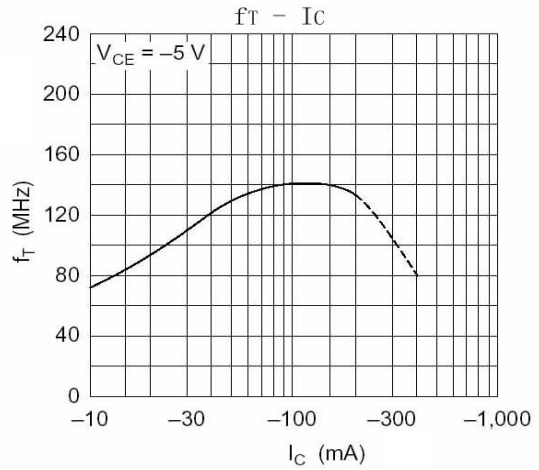
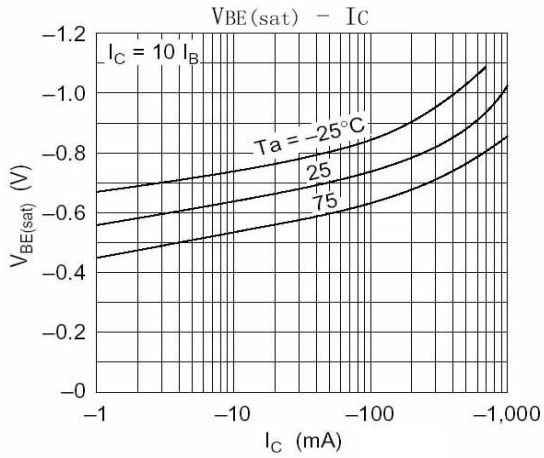
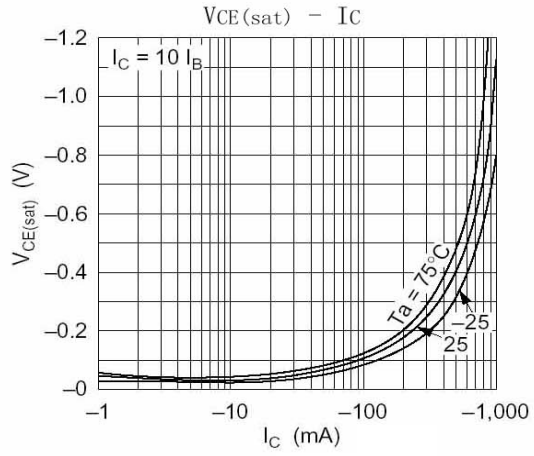
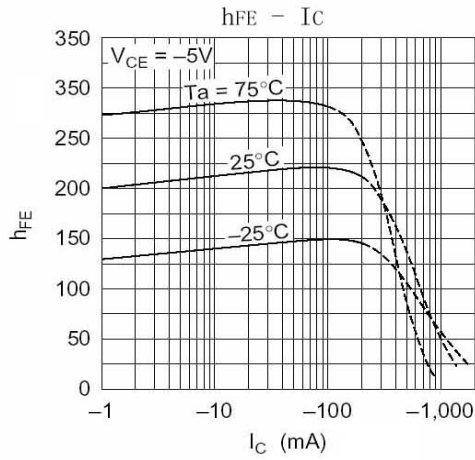

外形尺寸图 / Package Dimensions

T0-126

单位: mm

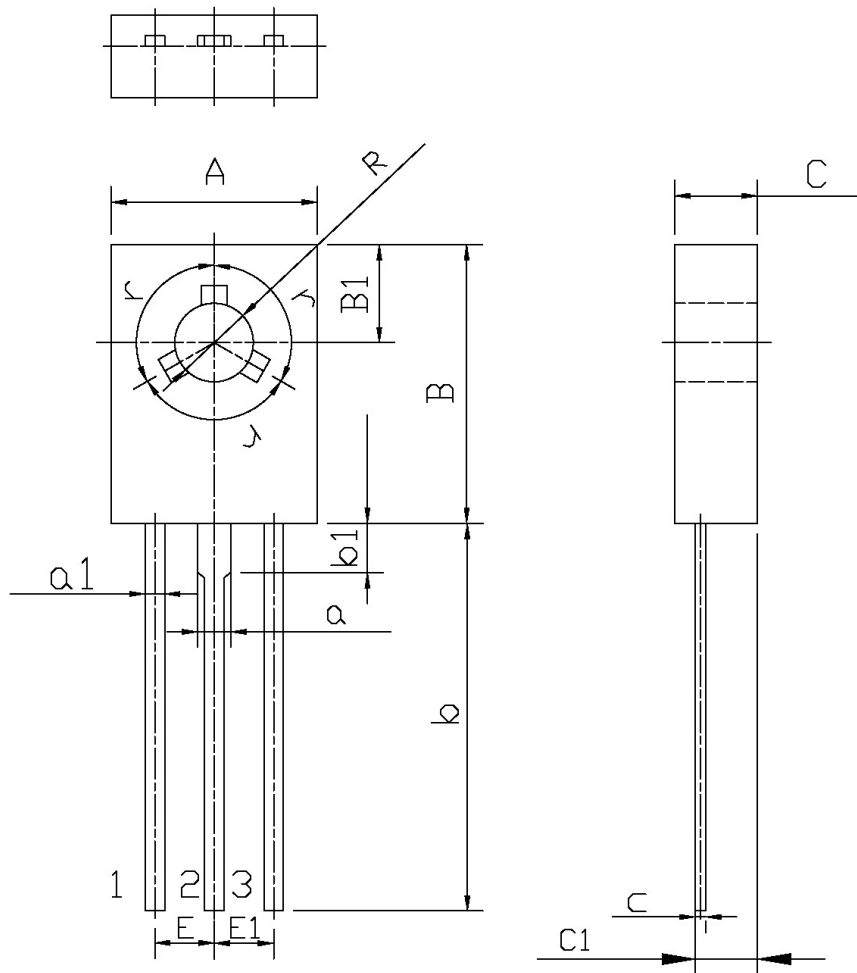

Symbol	Dimensions In Millimeters		Symbol	Dimensions In Millimeters	
	Min	Max		Min	Max
A	7.8	8.2	a1	0.66	0.86
B	10.6	11.0	E	2.1	2.5
B1	3.6	4.0	C	2.7	2.9
R	2.9	3.3	C1	1.57	1.77
b	14	16	c	0.3	0.6
b1	1.9		a	1.37	
E1	2.1	2.5	r	120°	

印章说明 / Marking Instructions

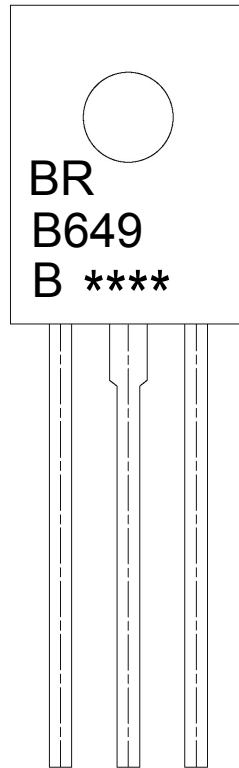

说明：

BR： 为公司代码

B649： 为型号代码

B： 为  $h_{FE}$  分档代码

\*\*\*\*： 为生产批号代码，随生产批号变化。

Note:

BR: Company Code

B649: Product Type.

B:  $h_{FE}$  Classifications Symbol

\*\*\*\*: Lot No. Code, code change with Lot No.

**波峰焊温度曲线图(无铅) / Temperature Profile for Dip Soldering(Pb-Free)**



说明：

- 1、预热温度 25 ~ 150°C，时间 60 ~ 90sec;
- 2、峰值温度 255±5°C，时间持续为 5±0.5sec;
- 3、焊接制程冷却速度为 2 ~ 10°C/sec.

Note:

- 1.Preheating:25~150°C, Time:60~90sec.
- 2.Peak Temp.:255±5°C, Duration:5±0.5sec.
3. Cooling Speed: 2~10°C/sec.

**耐焊接热试验条件 / Resistance to Soldering Heat Test Conditions**

温度：270±5°C

时间：10±1 sec.

Temp.:270±5°C

Time:10±1 sec

**包装规格 / Packaging SPEC.**

散件包装 / BULK

Package Type 封装形式	Units 包装数量					Dimension 包装尺寸 (unit: mm <sup>3</sup> )		
	Units/Tube 只/套管	Tubes/Inner Box 套管/盒	Units/Inner Box 只/盒	Inner Boxes/Outer Box 盒/箱	Units/Outer Box 只/箱	Tube 套管	Inner Box 盒	Outer Box 箱
TO-126/F	500	6	3,000	5	15,000	135×190	237×172×102	560×245×195

套管包装 / TUBE

Package Type 封装形式	Units 包装数量					Dimension 包装尺寸 (unit: mm <sup>3</sup> )		
	Units/Tube 只/套管	Tubes/Inner Box 套管/盒	Units/Inner Box 只/盒	Inner Boxes/Outer Box 盒/箱	Units/Outer Box 只/箱	Tube 套管	Inner Box 盒	Outer Box 箱
TO-126/F	65	26	1,690	5	8,450	532×31×5.6	555×164×50	575×290×180

**使用说明 / Notices**

## X-ON Electronics

Largest Supplier of Electrical and Electronic Components

*Click to view similar products for [Bipolar Transistors - BJT category](#):*

*Click to view products by [Blue Rocket manufacturer](#):*

Other Similar products are found below :

[619691C](#) [MCH4017-TL-H](#) [MMBT-2369-TR](#) [BC546/116](#) [BC557/116](#) [BSW67A](#) [NJVMJD148T4G](#) [NTE123AP-10](#) [NTE153MCP](#) [NTE16](#)  
[NTE195A](#) [NTE92](#) [C4460](#) [2N4401-A](#) [2N6728](#) [2SA1419T-TD-H](#) [2SA2126-E](#) [2SB1204S-TL-E](#) [2SC2712S-GR,LF](#) [2SC5488A-TL-H](#)  
[2SD2150T100R](#) [SP000011176](#) [2N2907A](#) [2N3904-NS](#) [2N5769](#) [2SC2412KT146S](#) [2SD1816S-TL-E](#) [CPH6501-TL-E](#) [MCH4021-TL-E](#)  
[MJE340](#) [US6T6TR](#) [NJL0281DG](#) [732314D](#) [CPH3121-TL-E](#) [CPH6021-TL-H](#) [873787E](#) [IMZ2AT108](#) [UMX21NTR](#) [MCH6102-TL-E](#)  
[NJL0302DG](#) [2N3583](#) [30A02MH-TL-E](#) [NSV40301MZ4T1G](#) [NTE13](#) [NTE26](#) [NTE282](#) [NTE323](#) [NTE350](#) [NTE81](#) [STX83003-AP](#)