

### 描述 / Descriptions

TO-220 塑封封装电压调整器。Voltage Regulator in a TO-220 Plastic Package.

### 特征 / Features

三端稳压调整器，输出电流高达 1.5A,内设过热保护和短路限制。

3-Terminal regulators ,output current up to 1.5 A, internal thermal overload protection and short-circuit limiting.

### 用途 / Applications

电压调整器。

Voltage Regulator.

### 内部等效电路/应用电路 / Equivalent Circuit or Application Circuit

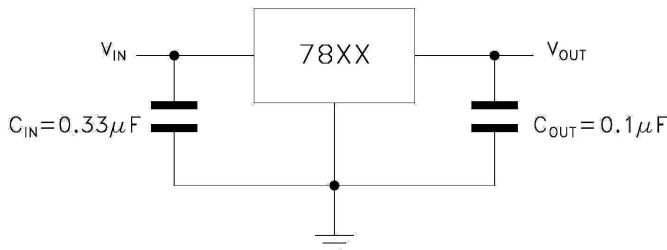

### 引脚排列 / Pinning

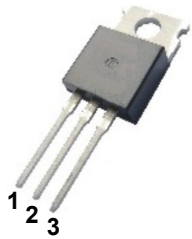

PIN 1 : IN

PIN 2 : GND

PIN 3 : OUT

### 印章代码 / Marking

见印章说明。See Marking Instructions.

**极限参数 / Absolute Maximum Ratings(Ta=25°C)**

参数 Parameter	符号 Symbol	数值 Rating	单位 Unit
Input Voltage Difference	V <sub>I</sub>	35	V
Junction-to-Ambient	R <sub>θJA</sub>	50	°C/W
Junction-to-Case	R <sub>θJC</sub>	5.0	°C/W
Operating Temperature Range	T <sub>OPR</sub>	0~125	°C
Storage temperature range	T <sub>stg</sub>	-65~150	°C

**电性能参数 / Electrical Characteristics(Ta=25°C , V<sub>i</sub>=19V,I<sub>o</sub>=500mA , unless otherwise specified)**

参数 Parameter	符号 Symbol	测试条件 Test Conditions	最小值 Min	典型值 Typ	最大值 Max	单位 Unit
Output Voltage	V <sub>O</sub>	T <sub>j</sub> =25°C	11.5	12.0	12.5	V
		V <sub>i</sub> =14.5V-27V I <sub>o</sub> =5mA-1A      P <sub>o</sub> ≤15W	11.4	12.0	12.6	
Load Regulation	ΔV <sub>Load</sub>	T <sub>j</sub> =25°C I <sub>o</sub> =5.0mA-1.5A			240	mV
		T <sub>j</sub> =25°C I <sub>o</sub> =250mA-750mA			120	
Line Regulation	ΔV <sub>Line</sub>	T <sub>j</sub> =25°C V <sub>i</sub> =14.5V-30V			240	mV
		T <sub>j</sub> =25°C V <sub>i</sub> =16V-22V			120	
Quiescent Current	I <sub>q</sub>	T <sub>j</sub> =25°C			8.0	mA
Quiescent Current Change	ΔI <sub>q</sub>	V <sub>i</sub> =14.5V-30V			1.0	mA
		I <sub>o</sub> =5mA-1A			0.5	mA
Output Voltage Drift	ΔV <sub>o</sub> /ΔT	I <sub>o</sub> =5mA		-1		mV/°C
Output Noise Voltage	e <sub>N</sub>	B=10Hz-100KHz T <sub>j</sub> =25°C		75		μV/V <sub>o</sub>
Supply Voltage Rejection	SVR	V <sub>i</sub> =15V-25V      f=120Hz	55			dB
Dropout Voltage	V <sub>d</sub>	I <sub>o</sub> =1A      T <sub>j</sub> =25°C		2.0		V
Output Resistance	R <sub>o</sub>	f=1KHz		18		mΩ
Short Circuit Current	I <sub>sc</sub>	V <sub>i</sub> =35V      T <sub>j</sub> =25°C		0.35		A
Short Circuit Peak Current	I <sub>scp</sub>	T <sub>j</sub> =25°C		2.2		A

电参数曲线图 / Electrical Characteristic Curve

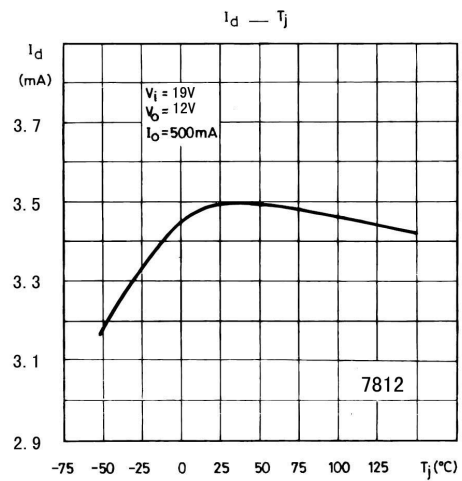
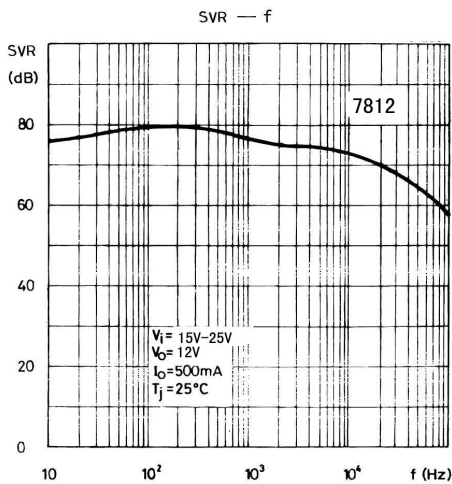
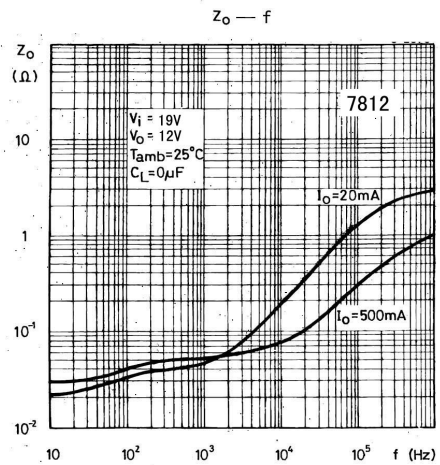
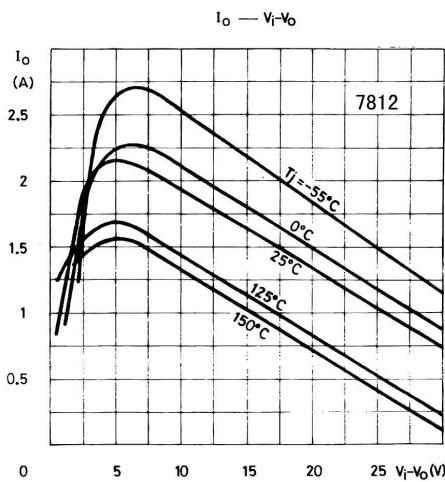
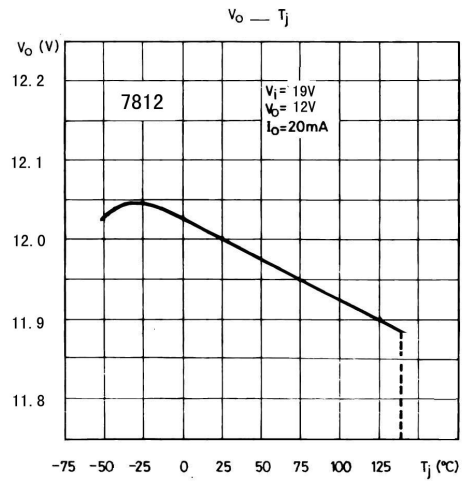
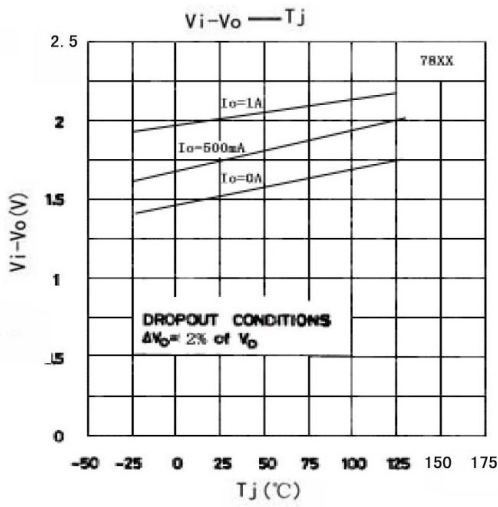

外形尺寸图 / Package Dimensions

TO-220

单位: mm

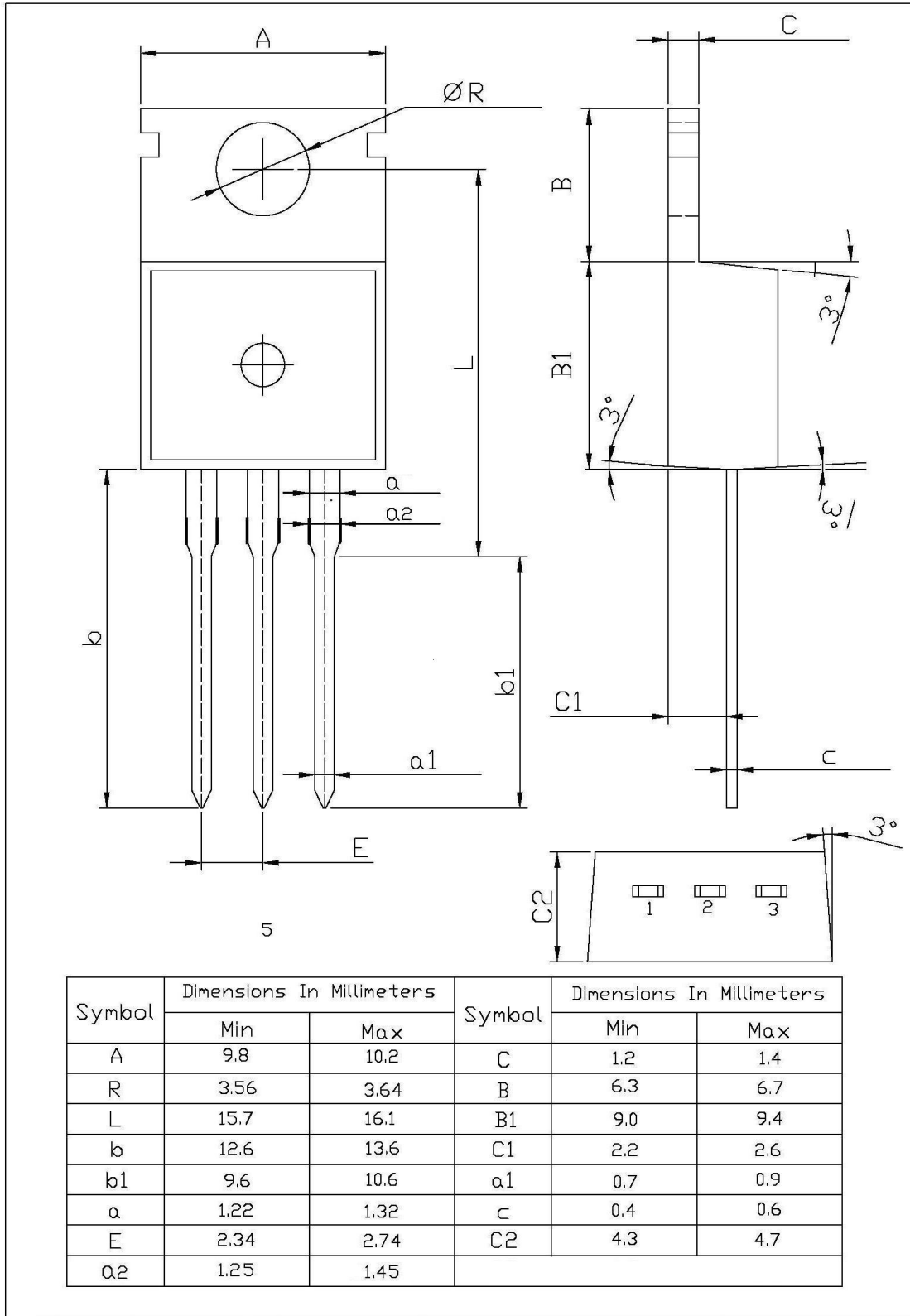

印章说明 / Marking Instructions

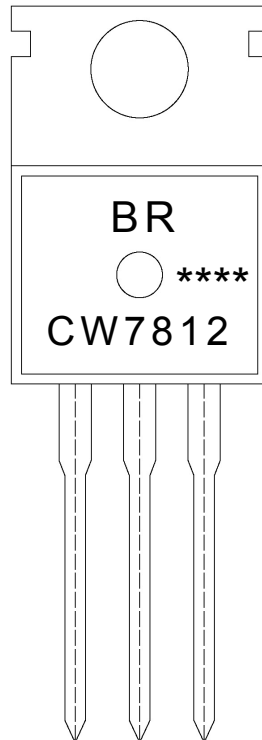

说明：

BR： 为公司代码

CW7812： 为型号代码

\*\*\*\*： 为生产批号代码，随生产批号变化。

Note:

BR: Company Code.

CW7812: Product Type.

\*\*\*\*: Lot No. Code, code change with Lot No.

**波峰焊温度曲线图(无铅) / Temperature Profile for Dip Soldering(Pb-Free)**

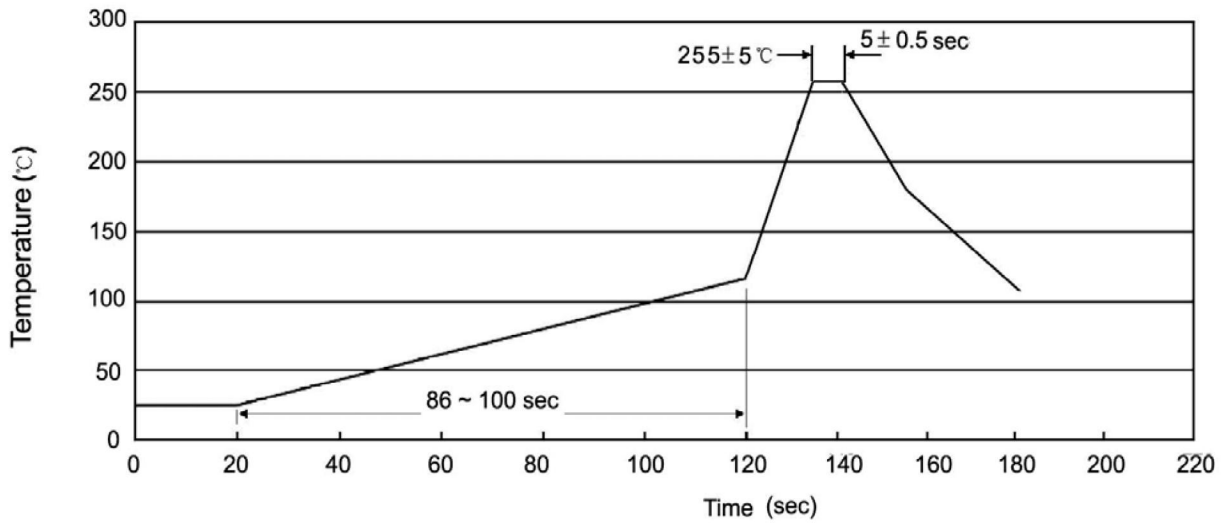

说明：

- 1、预热温度 25~150°C，时间 60~90sec;
- 2、峰值温度 255±5°C，时间持续为 5±0.5sec;
- 3、焊接制程冷却速度为 2~10°C/sec.

Note:

- 1.Preheating:25~150°C, Time:60~90sec.
- 2.Peak Temp.:255±5°C, Duration:5±0.5sec.
3. Cooling Speed: 2~10°C/sec.

**耐焊接热试验条件 / Resistance to Soldering Heat Test Conditions**

温度：270±5°C      时间：10±1 sec.      Temp:270±5°C      Time:10±1 sec

**包装规格 / Packaging SPEC.**

散件包装 / BULK

Package Type 封装形式	Units 包装数量					Dimension 包装尺寸 (unit: mm3)		
	Units/Bag 只/袋	Bags/Inner Box 袋/盒	Units/Inner Box 只/盒	Inner Boxes/Outer Box 盒/箱	Units/Outer Box 只/箱	Bag 袋	Inner Box 盒	Outer Box 箱
TO-220/F	200	10	2,000	5	10,000	135×190	237×172×102	560×245×195

套管包装 / TUBE

Package Type 封装形式	Units 包装数量					Dimension 包装尺寸 (unit: mm3)		
	Units/Tube 只/套管	Tubes/Inner Box 套管/盒	Units/Inner Box 只/盒	Inner Boxes/Outer Box 盒/箱	Units/Outer Box 只/箱	Tube 套管	Inner Box 盒	Outer Box 箱
TO-220/F	50	20	1,000	5	5,000	532×31.4×5.5	555×164×50	575×290×180

**使用说明 / Notices**

## X-ON Electronics

Largest Supplier of Electrical and Electronic Components

*Click to view similar products for [Linear Voltage Regulators](#) category:*

*Click to view products by [Blue Rocket](#) manufacturer:*

Other Similar products are found below :

[LV56831P-E](#) [LV5684PVD-XH](#) [MCDTSA6-2R](#) [L7815ACV-DG](#) [PQ3DZ53U](#) [LV56801P-E](#) [TLE42794G](#) [L78L05CZ/1SX](#) [L78LR05DL-MA-E](#) [636416C](#) [714954EB](#) [BA033LBSG2-TR](#) [LV5680P-E](#) [L78M15CV-DG](#) [TLS202B1MBV33HTSA1](#) [L79M05T-E](#) [TLS202A1MBVHTSA1](#) [L78LR05D-MA-E](#) [NCV317MBTG](#) [NTE7227](#) [LV5680NPVC-XH](#) [LT1054CN8](#) [MP2018GZD-5-Z](#) [MP2018GZD-33-Z](#) [MIC5281-3.3YMM](#) [RT9078-28GQZ](#) [MC78L06BP-AP](#) [TA48LS05F\(TE85L,F\)](#) [TC47BR5003ECT](#) [TCR2LN12,LF\(S](#) [TCR2LN28,LF\(S](#) [TCR2LN30,LF\(S](#) [TCR3DF295,LM\(CT](#) [TCR3DF40,LM\(CT](#) [BA178M20CP-E2](#) [L78M05TL-TL-E](#) [L78M12ABDT](#) [LR645N3-G-P003](#) [LR645N3-G-P013](#) [ZXTR2005P5-13](#) [SCD7812BTG](#) [TCR3DF335,LM\(CT](#) [ZXTR2012K-13](#) [TLE42994E V33](#) [ZXTR2008K-13](#) [ZXTR2005K-13](#) [L88R05DL-E](#) [ADP3300ARTZ-2.7RL7](#) [LM120K-15/883](#) [IFX54441LDVXUMA1](#)