

## 描述 / Descriptions

TO-92 塑封封装电压调整器。Voltage Regulator in a TO-92 Plastic Package.

## 特征 / Features

三端稳压调整器，输出电流高达 100mA,内设过热保护和短路限制。

3-Terminal regulators ,output current up to 100 mA, internal thermal overload protection and short-circuit limiting.

## 用途 / Applications

电压调整器。

Voltage Regulator.

## 内部等效电路/应用电路 / Equivalent Circuit or Application Circuit

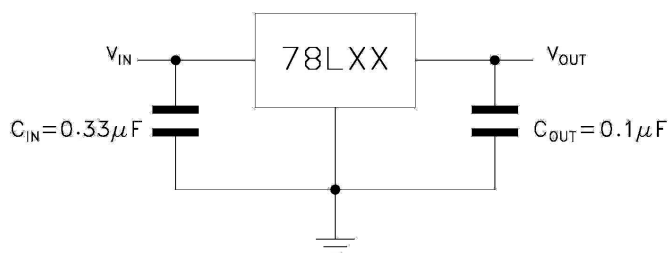

## 引脚排列 / Pinning



PIN 1 : IN

PIN 2 : GND

PIN 3 : OUT

## 印章代码 / Marking

见印章说明。See Marking Instructions

**极限参数 / Absolute Maximum Ratings(Ta=25°C)**

参数 Parameter	符号 Symbol	数值 Rating	单位 Unit
Input voltage	$V_I$	35	V
Output current	$I_O$	100	mA
Operating temperature range	$T_{OPR}$	0~125	°C
Power Dissipation	$P_D$	500	mW
Storage temperature range	$T_{stg}$	-65~150	°C
Junction temperature range	$T_J$	150	°C

**电性能参数 / Electrical Characteristics(Ta=25°C , Vi=19V,Io=40mA , unless otherwise specified)**

参数 Parameter	符号 Symbol	测试条件 Test Conditions	最小值 Min	典型值 Typ	最大值 Max	单位 Unit
Output voltage	$V_O$	$I_O=40mA$ $T_J=25^\circ C$	11.5	12	12.5	V
		$I_O=1mA$ to 40mA $V_I=14V$ to 27V	11.4	12	12.6	V
		$I_O=1mA$ to 70mA $V_I=19V$	11.4	12	12.6	V
Input regulation	$\Delta V_O$	$V_I=14.5V$ to 27V $T_J=25^\circ C$		55	250	mV
		$V_I=16V$ to 27V $T_J=25^\circ C$		49	200	mV
Ripple rejection	RR	$V_I=15V$ to 25V $T_J=25^\circ C$ $f=120Hz$	37	42		dB
Output regulation	$\Delta V_O$	$I_O=1mA$ to 100mA $T_J=25^\circ C$		22	100	mV
		$I_O=1mA$ to 40mA $T_J=25^\circ C$		13	50	mV
Output noise voltage	$V_N$	$f=10Hz$ to 100KHz $T_J=25^\circ C$		70		$\mu V$
Dropout voltage	$V_D$	$T_J=25^\circ C$		1.7		$\mu V$
Bias current	$I_Q$	$T_J=25^\circ C$		4.3	6.5	mA
		$T_J=125^\circ C$			6.0	mA
Bias current change	$\Delta I_Q$	$V_I=16V$ to 27V			1.5	mA
		$I_O=1mA$ to 40mA			0.1	mA

电参数曲线图 / Electrical Characteristic Curve

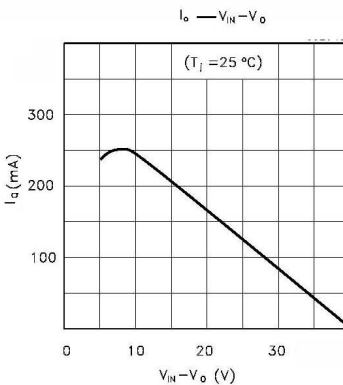
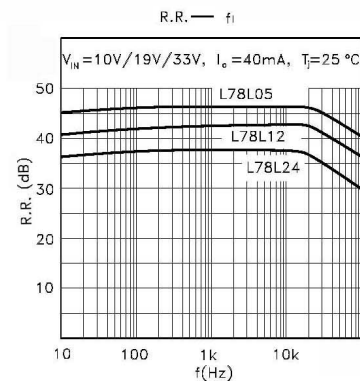
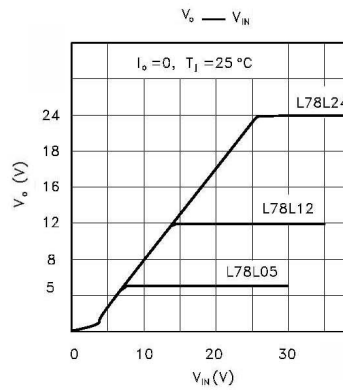
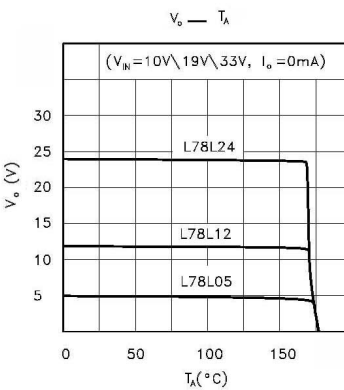
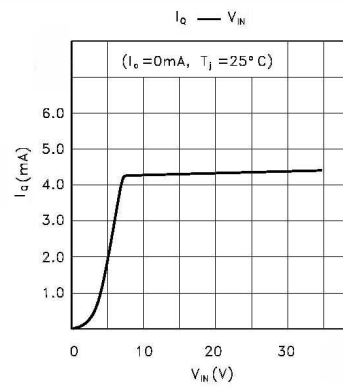
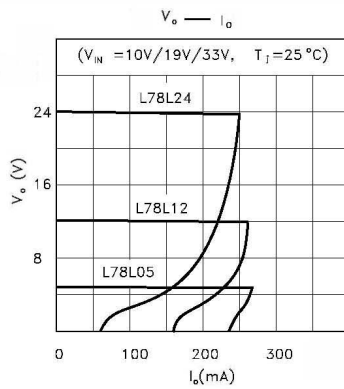
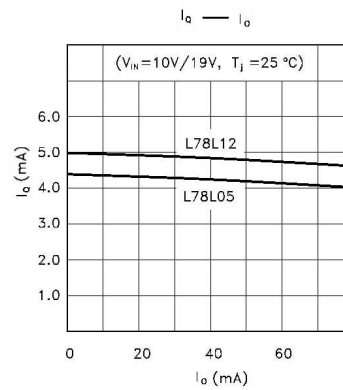
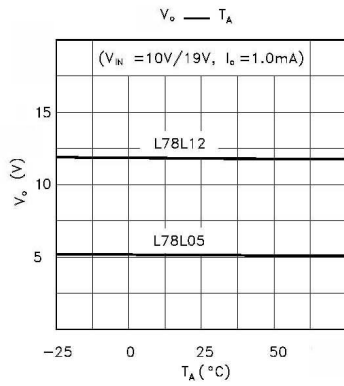

外形尺寸图 / Package Dimensions

TO-92

Unit: mm

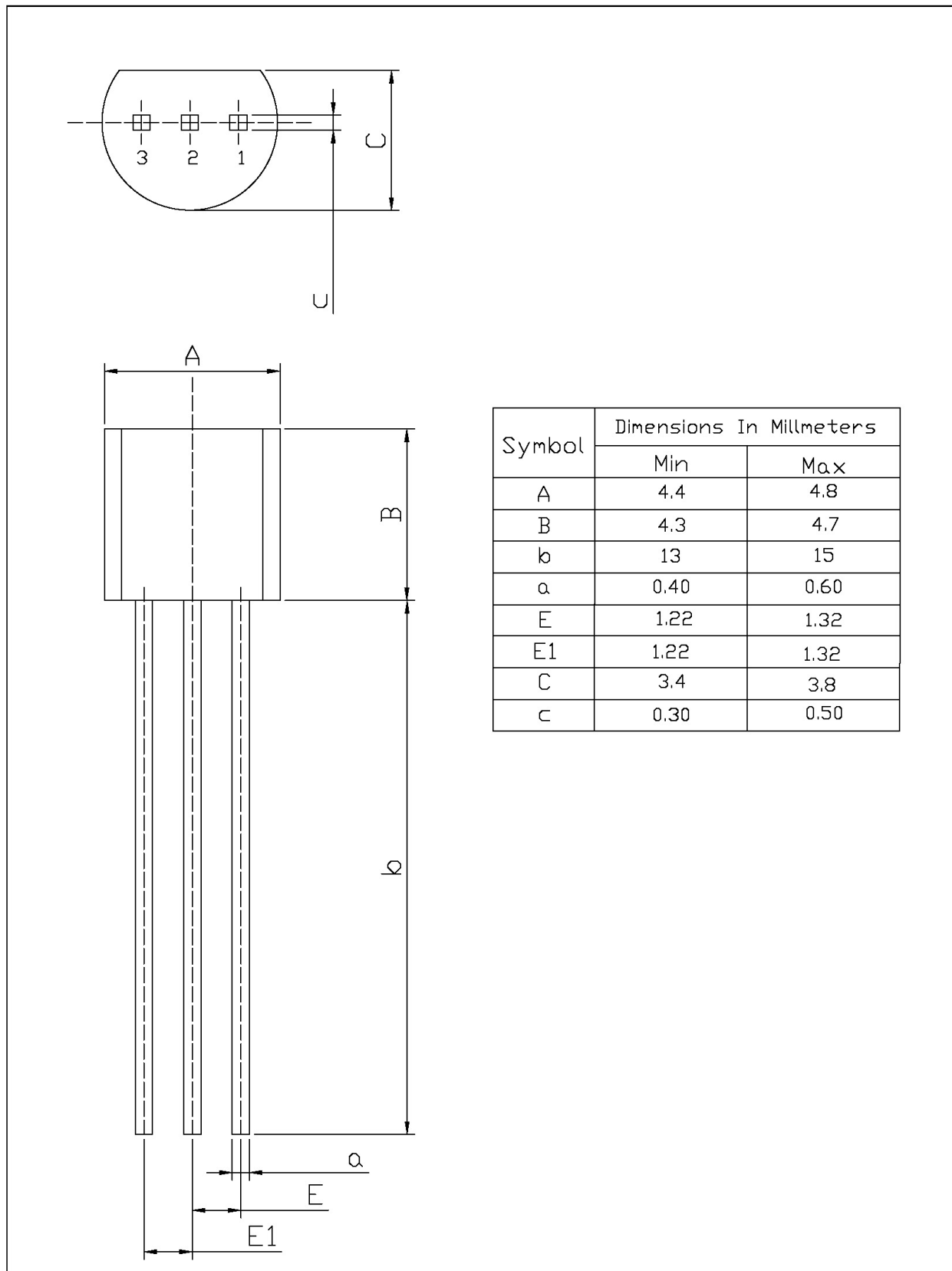

印章说明 / Marking Instructions

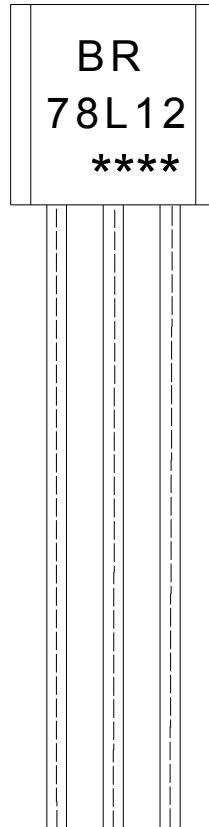

说明：

BR： 为公司代码

78L12： 为产品型号

\*\*\*\*： 为生产批号代码，随生产批号变化。

Note:

BR: Company Code.

78L12: Product Type.

\*\*\*\*: Lot No. Code, code change with Lot No.

**波峰焊温度曲线图(无铅) / Temperature Profile for Dip Soldering(Pb-Free)**

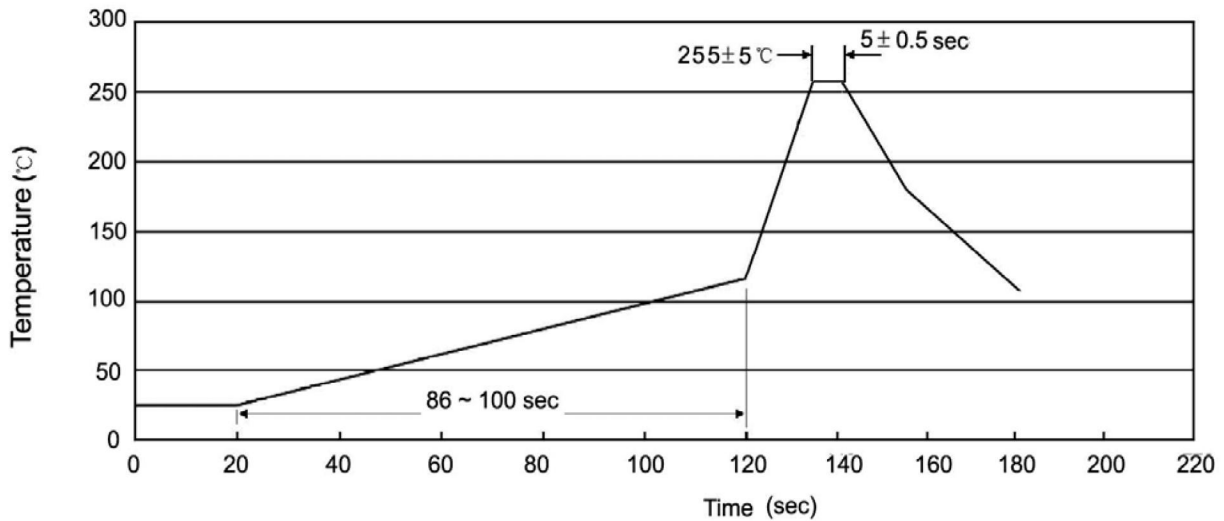

说明：

- 1、预热温度 25~150°C，时间 60~90sec;
- 2、峰值温度 255±5°C，时间持续为 5±0.5sec;
- 3、焊接制程冷却速度为 2~10°C/sec.

Note:

- 1.Preheating:25~150°C, Time:60~90sec.
- 2.Peak Temp.:255±5°C, Duration:5±0.5sec.
3. Cooling Speed: 2~10°C/sec.

**耐焊接热试验条件 / Resistance to Soldering Heat Test Conditions**

温度：270±5°C      时间：10±1 sec.      Temp:270±5°C      Time:10±1 sec

**包装规格 / Packaging SPEC.**

散件包装 / BULK

Package Type 封装形式	Units 包装数量					Dimension 包装尺寸 (unit: mm3)		
	Units/Bag 只/袋	Bags/Inner Box 袋/盒	Units/Inner Box 只/盒	Inner Boxes/Outer Box 盒/箱	Units/Outer Box 只/箱	Bag 袋	Inner Box 盒	Outer Box 箱
TO-92	1,000	10	10,000	5	50,000	135×190	237×172×102	560×245×195
	1,000	10	10,000	10	100,000	135×190	237×172×102	560×245×375

编带包装 / AMMO

Package Type 封装形式	Units 包装数量					Dimension 包装尺寸 (unit: mm3)	
	Units/tape 只/纸带	Tape/Inner Box 纸带/盒	Rows/Inner Box 纸带层/盒	Inner Boxes/Outer Box 盒/箱	Units/Outer Box 只/箱	Inner Box 盒	Outer Box 箱
TO-92	3,000	1	120	10	30,000	328×230×42	小箱 480×346×235, 大箱 547×407×268

**使用说明 / Notices**

## X-ON Electronics

Largest Supplier of Electrical and Electronic Components

*Click to view similar products for [Linear Voltage Regulators](#) category:*

*Click to view products by [Blue Rocket](#) manufacturer:*

Other Similar products are found below :

[LV5684PVD-XH](#) [MCDTSA6-2R](#) [L7815ACV-DG](#) [LV56801P-E](#) [UA7805CKC](#) [714954EB](#) [ZMR500QFTA](#) [BA033LBSG2-TR](#)  
[NCV78M05ABDTRKG](#) [LV5680P-E](#) [L79M05T-E](#) [L78LR05D-MA-E](#) [NCV317MBTG](#) [NTE7227](#) [MP2018GZD-33-P](#) [MP2018GZD-5-P](#)  
[LV5680NPVC-XH](#) [ZTS6538SE](#) [UA78L09CLP](#) [UA78L09CLPR](#) [CAT6221-PPTD-GT3](#) [MC78M09CDTRK](#) [NCV51190MNTAG](#)  
[BL1118CS8TR1833](#) [BL8563CKETR18](#) [BL8077CKETR33](#) [BL9153-33CC3TR](#) [BL9161G-15BADRN](#) [BL9161G-28BADRN](#)  
[BRCO7530MMC](#) [CJ7815B-TFN-ARG](#) [LM317C](#) [GM7333K](#) [GM7350K](#) [XC6206P332MR](#) [HT7533](#) [LM7912S/TR](#) [LT1764S/TR](#) [LM7805T](#)  
[LM338T](#) [LM1117IMP-3.3/TR](#) [HT1117AM-3.3](#) [HT7550S](#) [AMS1117-3.3](#) [HT7150S](#) [78L12](#) [HT7550](#) [HT7533-1](#) [HXY6206I-2.5](#) [HT7133](#)