

**描述 / Descriptions**

TO-92 塑封封装 NPN 半导体三极管。Silicon NPN transistor in a TO-92 Plastic Package.

**特征 / Features**

$P_C, I_C$  大, 与 8550 互补。

High  $P_C$  and  $I_C$ , complementary pair with 8550.

**用途 / Applications**

用于 2W 乙类推挽功放。

2W output amplifier of portable radios in class B push-pull operation.

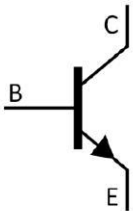
**内部等效电路 / Equivalent Circuit****引脚排列 / Pinning**

PIN 1 : Collector      PIN 2 : Base      PIN 3 : Emitter

**放大及印章代码 /  $h_{FE}$  Classifications & Marking**

$h_{FE}$ Classifications Symbol	B	C	D
$h_{FE}$ Range	85~160	120~200	160~300

**极限参数 / Absolute Maximum Ratings(Ta=25°C)**

参数 Parameter	符号 Symbol	数值 Rating	单位 Unit
Collector to Base Voltage	$V_{CB0}$	40	V
Collector to Emitter Voltage	$V_{CE0}$	25	V
Emitter to Base Voltage	$V_{EB0}$	6	V
Collector Current - Continuous	$I_C$	1.5	A
Base Current	$I_B$	0.5	A
Collector Power Dissipation	$P_C$	1.0	W
Junction Temperature	$T_j$	150	°C
Storage Temperature Range	$T_{stg}$	-55 ~ 150	°C

**电性能参数 / Electrical Characteristics(Ta=25°C)**

参数 Parameter	符号 Symbol	测试条件 Test Conditions	最小值 Min	典型值 Typ	最大值 Max	单位 Unit
Collector to Base Breakdown Voltage	$V_{CB0}$	$I_C=0.1mA$ $I_E=0$	40			V
Collector to Emitter Breakdown Voltage	$V_{CE0}$	$I_C=2.0mA$ $I_B=0$	25			V
Emitter to Base Breakdown Voltage	$V_{EB0}$	$I_E=0.1mA$ $I_C=0$	6.0			V
Collector Cut-Off Current	$I_{CB0}$	$V_{CB}=35V$ $I_E=0$			0.1	$\mu A$
Emitter Cut-Off Current	$I_{EB0}$	$V_{EB}=6.0V$ $I_C=0$			0.1	$\mu A$
DC Current Gain	$h_{FE(1)}$	$V_{CE}=1.0V$ $I_C=100mA$	85		300	
	$h_{FE(2)}$	$V_{CE}=1.0V$ $I_C=800mA$	40			
	$h_{FE(3)}$	$V_{CE}=1.0V$ $I_C=5.0mA$	45			
Collector to Emitter Saturation Voltage	$V_{CE(sat)}$	$I_C=800mA$ $I_B=80mA$		0.28	0.5	V
Base to Emitter Saturation Voltage	$V_{BE(sat)}$	$I_C=800mA$ $I_B=80mA$		0.98	1.2	V
Base to Emitter Voltage	$V_{BE}$	$V_{CE}=1.0V$ $I_C=10mA$		0.66	1.0	V
Transition Frequency	$f_T$	$I_C=50mA$ $V_{CE}=10V$	100	200		MHz
Collector Output Capacitance	$C_{ob}$	$V_{CB}=10V$ $f=1.0MHz$ $I_E=0$		15		pF

电参数曲线图 / Electrical Characteristic Curve

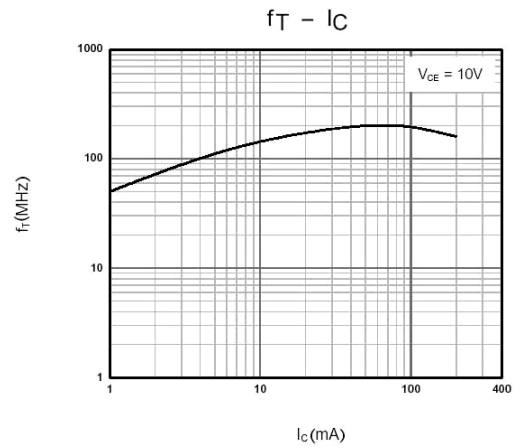
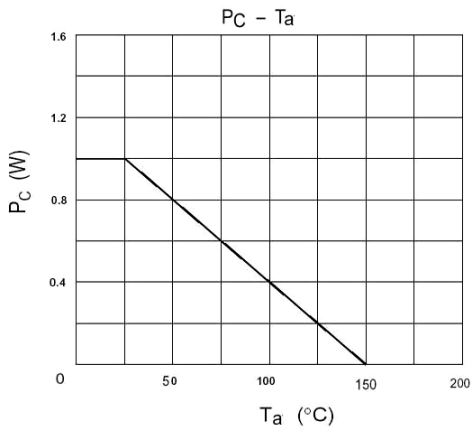
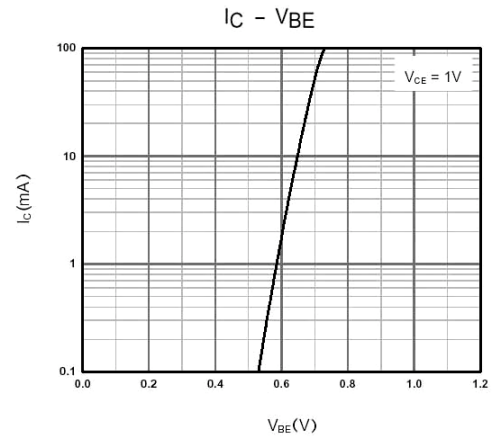
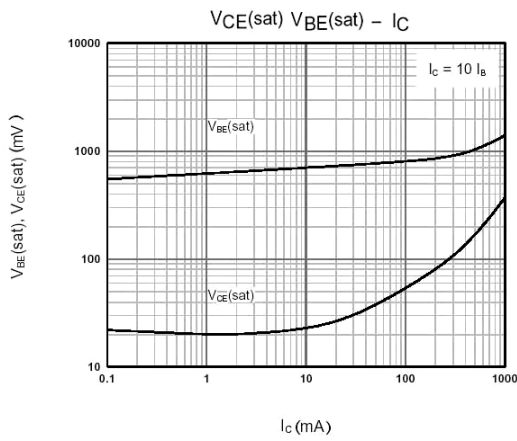
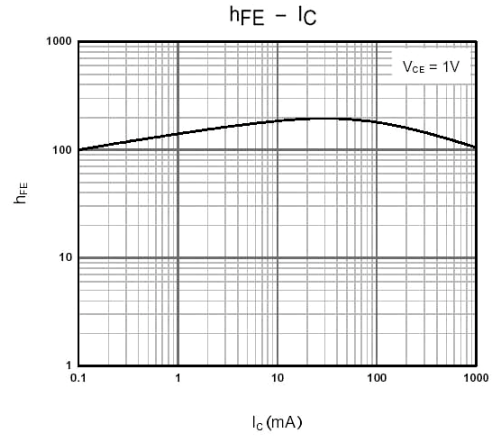
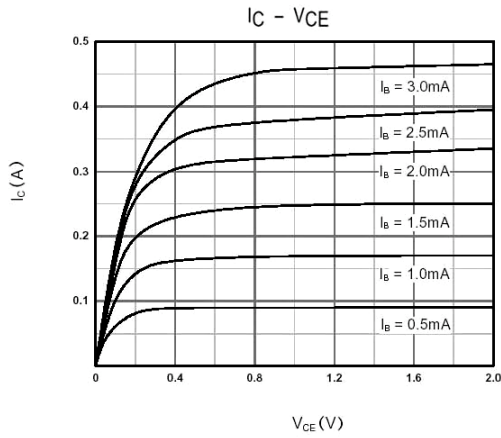

外形尺寸图 / Package Dimensions

TO-92

Unit: mm

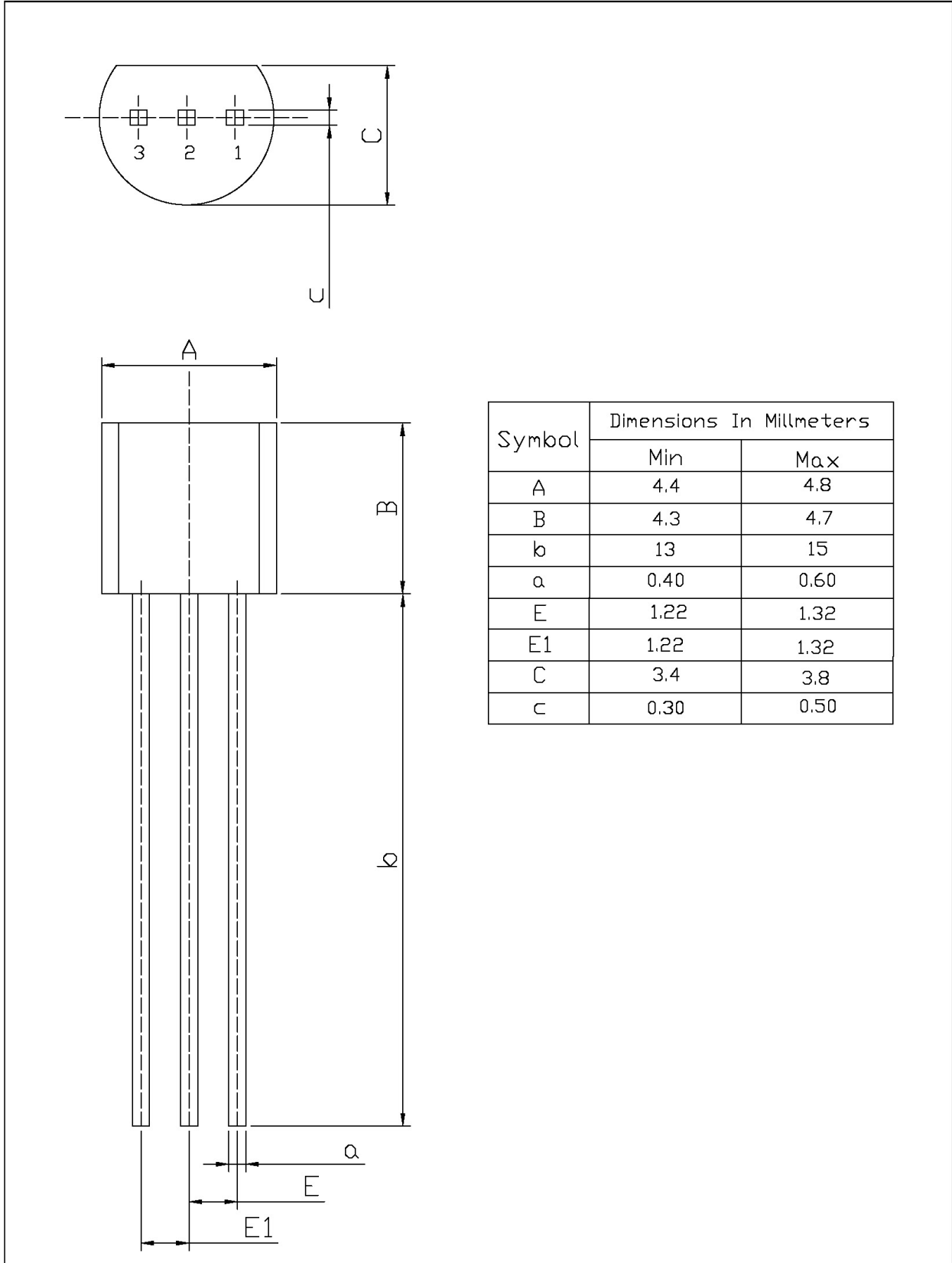

Symbol	Dimensions In Millimeters	
	Min	Max
A	4.4	4.8
B	4.3	4.7
b	13	15
a	0.40	0.60
E	1.22	1.32
E1	1.22	1.32
C	3.4	3.8
c	0.30	0.50

## 印章说明 / Marking Instructions

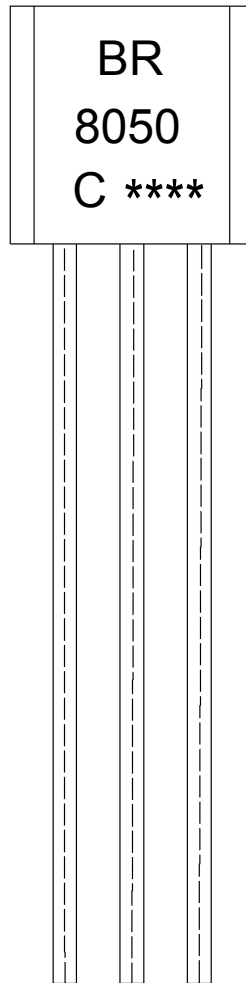

说明：

BR： 为公司代码

8050： 为产品型号

C： 为  $h_{FE}$  分档代码

\*\*\*\*： 为生产批号代码，随生产批号变化。

Note:

BR: Company Code.

8050: Product Type.

C:  $h_{FE}$  Classifications Symbol.

\*\*\*\*: Lot No. Code, code change with Lot No.

**波峰焊温度曲线图(无铅) / Temperature Profile for Dip Soldering(Pb-Free)**



说明：

- 1、预热温度 25 ~ 150°C，时间 60 ~ 90sec;
- 2、峰值温度 255±5°C，时间持续为 5±0.5sec;
- 3、焊接制程冷却速度为 2 ~ 10°C/sec.

Note:

- 1.Preheating:25~150°C, Time:60~90sec.
- 2.Peak Temp.:255±5°C, Duration:5±0.5sec.
3. Cooling Speed: 2~10°C/sec.

**耐焊接热试验条件 / Resistance to Soldering Heat Test Conditions**

温度：270±5°C

时间：10±1 sec.

Temp.:270±5°C

Time:10±1 sec

**包装规格 / Packaging SPEC.**

散件包装 / BULK

Package Type 封装形式	Units 包装数量					Dimension 包装尺寸 (unit: mm3)		
	Units/Bag 只/袋	Bags/Inner Box 袋/盒	Units/Inner Box 只/盒	Inner Boxes/Outer Box 盒/箱	Units/Outer Box 只/箱	Bag 袋	Inner Box 盒	Outer Box 箱
TO-92	1,000	10	10,000	5	50,000	135×190	237×172×102	560×245×195
	1,000	10	10,000	10	100,000	135×190	237×172×102	560×245×375

编带包装 / AMMO

Package Type 封装形式	Units 包装数量					Dimension 包装尺寸 (unit: mm3)	
	Units/tape 只/纸带	Tape/Inner Box 纸带/盒	Rows/Inner Box 纸带层/盒	Inner Boxes/Outer Box 盒/箱	Units/Outer Box 只/箱	Inner Box 盒	Outer Box 箱
TO-92	3,000	1	120	10	30,000	328×230×42	小箱 480×346×235, 大箱 547×407×268

**使用说明 / Notices**

## X-ON Electronics

Largest Supplier of Electrical and Electronic Components

*Click to view similar products for [Bipolar Transistors - BJT category](#):*

*Click to view products by [Blue Rocket manufacturer](#):*

Other Similar products are found below :

[619691C](#) [MCH4017-TL-H](#) [MMBT-2369-TR](#) [BC546/116](#) [BC557/116](#) [BSW67A](#) [NJVMJD148T4G](#) [NTE123AP-10](#) [NTE153MCP](#) [NTE16](#)  
[NTE195A](#) [NTE92](#) [C4460](#) [2N4401-A](#) [2N6728](#) [2SA1419T-TD-H](#) [2SA2126-E](#) [2SB1204S-TL-E](#) [2SC2712S-GR,LF](#) [2SC5488A-TL-H](#)  
[2SD2150T100R](#) [SP000011176](#) [2N2907A](#) [2N3904-NS](#) [2N5769](#) [2SC2412KT146S](#) [2SD1816S-TL-E](#) [CPH6501-TL-E](#) [MCH4021-TL-E](#)  
[MJE340](#) [US6T6TR](#) [NJL0281DG](#) [732314D](#) [CPH3121-TL-E](#) [CPH6021-TL-H](#) [873787E](#) [IMZ2AT108](#) [UMX21NTR](#) [MCH6102-TL-E](#)  
[NJL0302DG](#) [2N3583](#) [30A02MH-TL-E](#) [NSV40301MZ4T1G](#) [NTE13](#) [NTE26](#) [NTE282](#) [NTE323](#) [NTE350](#) [NTE81](#) [STX83003-AP](#)