

描述 / Descriptions

TO-92 塑封封装 PNP 半导体三极管。Silicon PNP transistor in a TO-92 Plastic Package.

特征 / Features

P_C 大, h_{FE} 高而且特性好, 与 9014 互补。

High P_C , excellent h_{FE} linearity, complementary pair with 9014.

用途 / Applications

用于低电平、低噪声的前置放大器。

Low frequency, low noise amplifier.

内部等效电路 / Equivalent Circuit**引脚排列 / Pinning**

PIN 1 : Collector PIN 2 : Base PIN 3 : Emitter

放大及印章代码 / h_{FE} Classifications & Marking

h_{FE} Classifications Symbol	A	B	C	D
h_{FE} Range	60~150	100~300	200~600	400~1000

极限参数 / Absolute Maximum Ratings(Ta=25°C)

参数 Parameter	符号 Symbol	数值 Rating	单位 Unit
Collector to Base Voltage	V_{CBO}	-50	V
Collector to Emitter Voltage	V_{CEO}	-45	V
Emitter to Base Voltage	V_{EBO}	-5.0	V
Collector Current - Continuous	I_C	-100	mA
Collector Power Dissipation	P_C	450	mW
Junction Temperature	T_j	150	°C
Storage Temperature Range	T_{stg}	-55~150	°C

电性能参数 / Electrical Characteristics(Ta=25°C)

参数 Parameter	符号 Symbol	测试条件 Test Conditions	最小值 Min	典型值 Typ	最大值 Max	单位 Unit
Collector to Base Breakdown Voltage	V_{CBO}	$I_C=-0.1mA$ $I_E=0$	-50			V
Collector to Emitter Breakdown Voltage	V_{CEO}	$I_C=-1.0mA$ $I_B=0$	-45			V
Emitter to Base Breakdown Voltage	V_{EBO}	$I_E=-0.1mA$ $I_C=0$	-5.0			V
Collector Cut-Off Current	I_{CBO}	$V_{CB}=-50V$ $I_E=0$			-0.05	μA
Emitter Cut-Off Current	I_{EBO}	$V_{EB}=-5.0V$ $I_C=0$			-0.05	μA
DC Current Gain	h_{FE}	$V_{CE}=-5.0V$ $I_C=-1.0mA$	60		1000	
Collector to Emitter Saturation Voltage	$V_{CE(sat)}$	$I_C=-100mA$ $I_B=-5.0mA$		-0.2	-0.7	V
Base to Emitter Saturation Voltage	$V_{BE(sat)}$	$I_C=-100mA$ $I_B=-5.0mA$		-0.82	-1.0	V
Base to Emitter Voltage	V_{BE}	$V_{CE}=-5.0V$ $I_C=-2.0mA$		-0.65	-0.75	V
Transition Frequency	f_T	$V_{CE}=-5.0V$ $I_C=-10mA$	100	190		MHz
Collector Output Capacitance	C_{ob}	$V_{CB}=-10V$ $I_E=0$ $f=1.0MHz$		4.5	7.0	pF
Noise Figure	NF	$V_{CE}=-5.0V$ $I_C=-0.2mA$ $R_g=2.0K\Omega$ $f=1.0KHz$ $\Delta f=200Hz$		0.7	10	dB

电参数曲线图 / Electrical Characteristic Curve

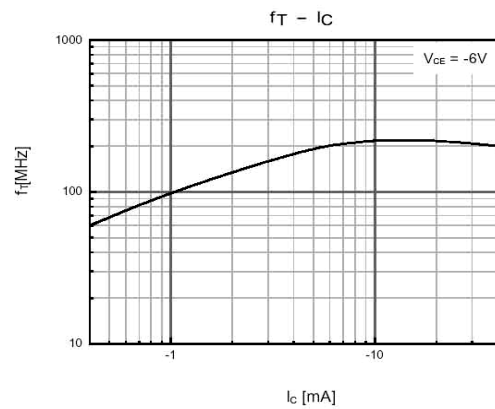
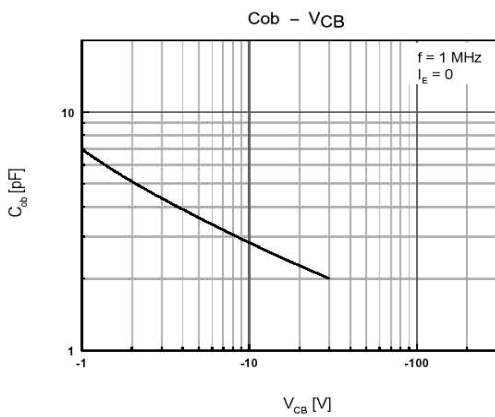
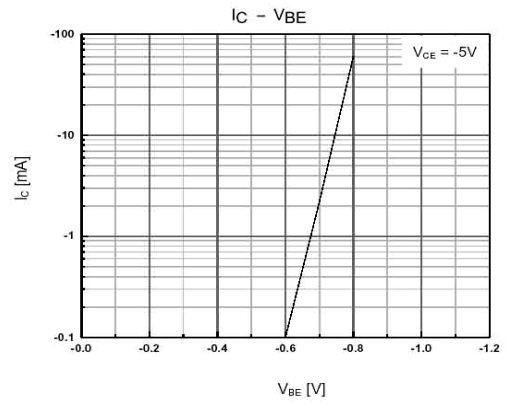
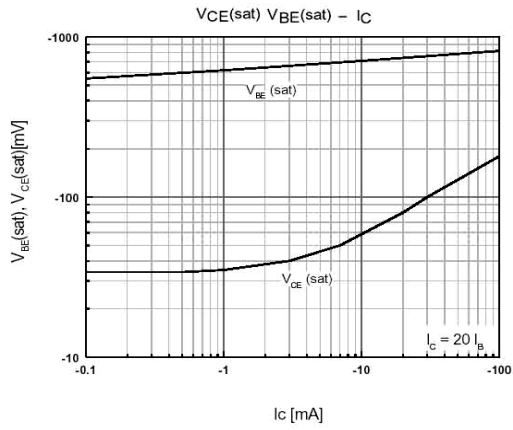
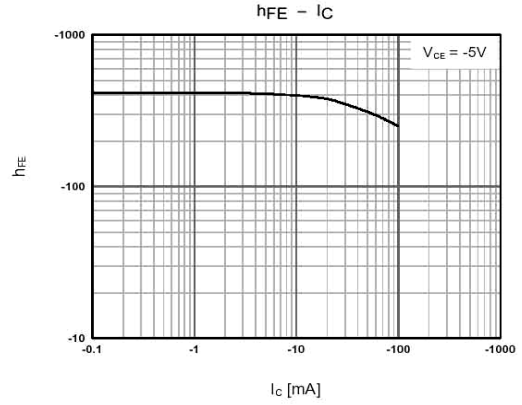
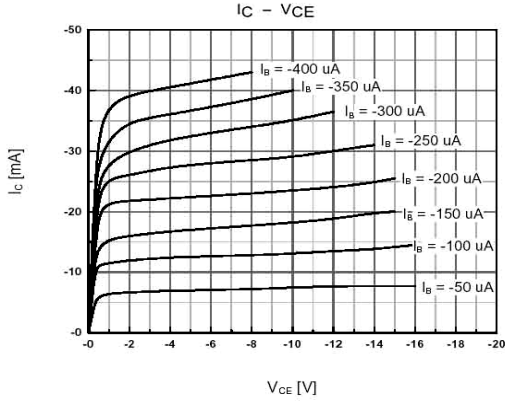

外形尺寸图 / Package Dimensions

T0-92

Unit: mm

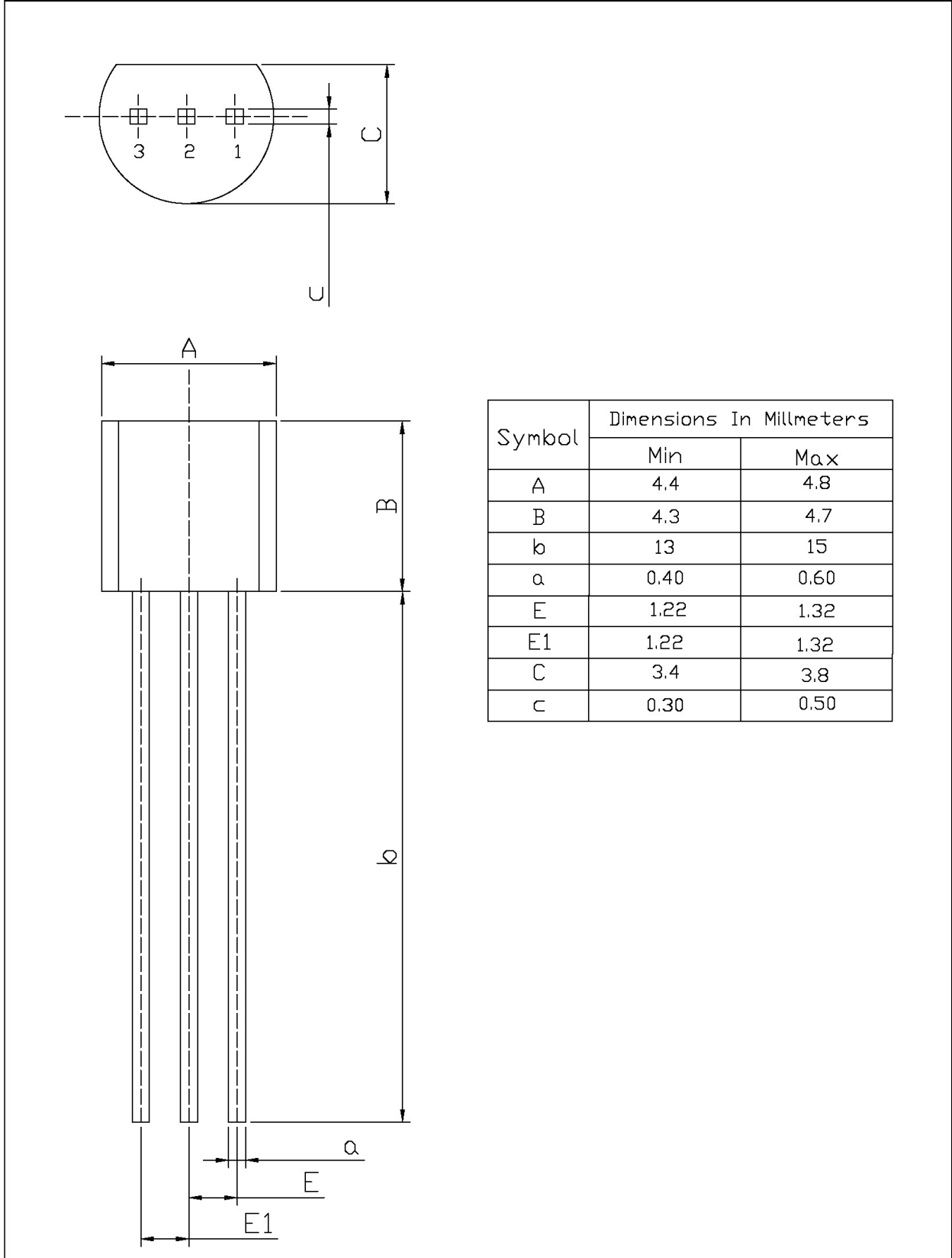

印章说明 / Marking Instructions

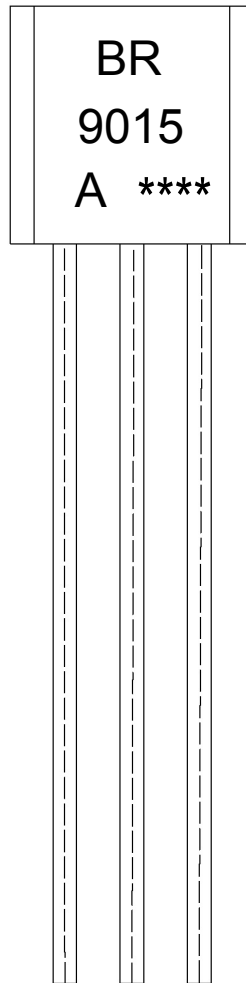

说明：

BR： 为公司代码

9015： 为产品型号

A： 为 h_{FE} 分档代码

****： 为生产批号代码，随生产批号变化。

Note:

BR: Company Code.

9015: Product Type.

A: h_{FE} Classifications Symbol.

****: Lot No. Code, code change with Lot No.

波峰焊温度曲线图(无铅) / Temperature Profile for Dip Soldering(Pb-Free)

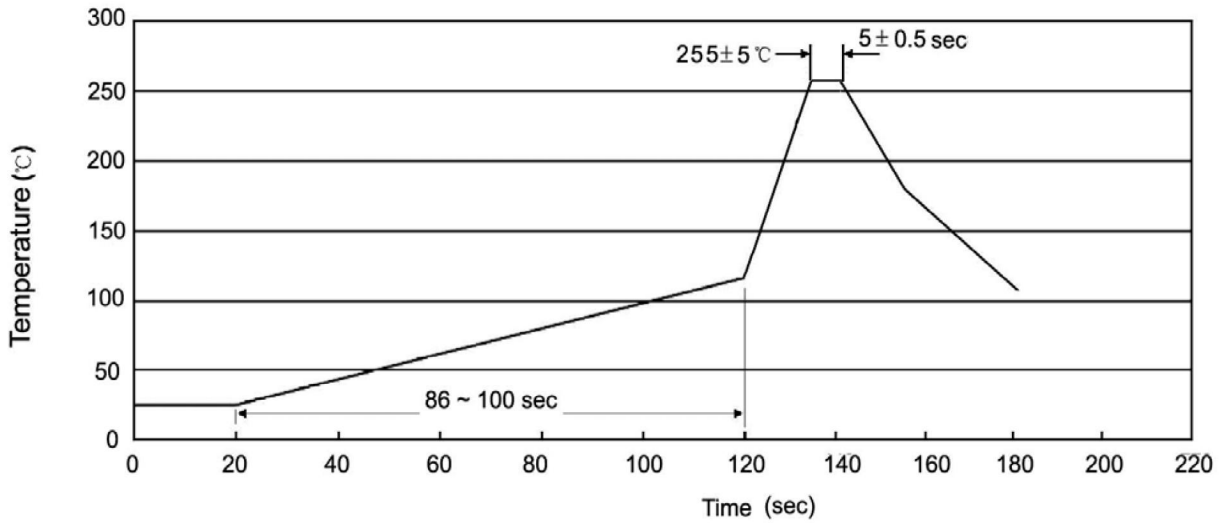

说明：

- 1、预热温度 25 ~ 150°C，时间 60 ~ 90sec;
- 2、峰值温度 255±5°C，时间持续为 5±0.5sec;
- 3、焊接制程冷却速度为 2 ~ 10°C/sec.

Note:

- 1.Preheating:25~150°C, Time:60~90sec.
- 2.Peak Temp.:255±5°C, Duration:5±0.5sec.
3. Cooling Speed: 2~10°C/sec.

耐焊接热试验条件 / Resistance to Soldering Heat Test Conditions

温度：270±5°C

时间：10±1 sec.

Temp.:270±5°C

Time:10±1 sec

包装规格 / Packaging SPEC.

散件包装 / BULK

Package Type 封装形式	Units 包装数量					Dimension 包装尺寸 (unit: mm3)		
	Units/Bag 只/袋	Bags/Inner Box 袋/盒	Units/Inner Box 只/盒	Inner Boxes/Outer Box 盒/箱	Units/Outer Box 只/箱	Bag 袋	Inner Box 盒	Outer Box 箱
TO-92	1,000	10	10,000	5	50,000	135×190	237×172×102	560×245×195
	1,000	10	10,000	10	100,000	135×190	237×172×102	560×245×375

编带包装 / AMMO

Package Type 封装形式	Units 包装数量					Dimension 包装尺寸 (unit: mm3)	
	Units/tape 只/纸带	Tape/Inner Box 纸带/盒	Rows/Inner Box 纸带层/盒	Inner Boxes/Outer Box 盒/箱	Units/Outer Box 只/箱	Inner Box 盒	Outer Box 箱
TO-92	3,000	1	120	10	30,000	328×230×42	小箱 480×346×235, 大箱 547×407×268

使用说明 / Notices

X-ON Electronics

Largest Supplier of Electrical and Electronic Components

Click to view similar products for [Bipolar Transistors - BJT category](#):

Click to view products by [Blue Rocket manufacturer](#):

Other Similar products are found below :

[619691C](#) [MCH4017-TL-H](#) [MMBT-2369-TR](#) [BC546/116](#) [BC557/116](#) [BSW67A](#) [NJVMJD148T4G](#) [NTE123AP-10](#) [NTE153MCP](#) [NTE16](#)
[NTE195A](#) [NTE92](#) [2N4401-A](#) [2N6728](#) [2SA1419T-TD-H](#) [2SA2126-E](#) [2SB1204S-TL-E](#) [2SC2712S-GR,LF](#) [2SC4731T-AY](#) [FJPF5304DTU](#)
[2N2907A](#) [2N3904-NS](#) [2N5769](#) [2SB1324-TD-E](#) [2SC2412KT146S](#) [2SC3332T](#) [2SC3902S](#) [2SC5231C8-TL-E](#) [2SD1685F](#) [CPH6501-TL-E](#)
[MCH4021-TL-E](#) [MJE340](#) [Jantx2N5416](#) [US6T6TR](#) [NJL0281DG](#) [732314D](#) [CPH3121-TL-E](#) [CPH6021-TL-H](#) [873787E](#) [IMZ2AT108](#)
[UMX21NTR](#) [MCH6102-TL-E](#) [NJL0302DG](#) [TTA1452B,S4X\(S](#) [NTE13](#) [NTE26](#) [NTE282](#) [NTE323](#) [NTE350](#) [NTE81](#)