

### 描述 / Descriptions

SOT-23 塑封封装 PNP 半导体三极管。Silicon PNP transistor in a SOT-23 Plastic Package.

### 特征 / Features

$P_C$  大,  $h_{FE}$  高且特性好, 与 9014M 互补。

High  $P_C$  and  $I_C$ , excellent  $h_{FE}$  linearity, complementary pair with 9014M.

### 用途 / Applications

用于低电平、低噪声的前置放大器。

low frequency, low noise pre-amplifier.

### 内部等效电路 / Equivalent Circuit

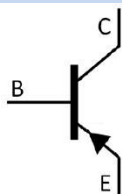

### 引脚排列 / Pinning



PIN 1 : Base      PIN 2 : Emitter      PIN 3 : Collector

### 放大及印章代码 / $h_{FE}$ Classifications & Marking

$h_{FE}$ Classifications Symbol	A	B	C	D
$h_{FE}$ Range	60~150	100~300	200~600	400~1000
Marking	HM6A	HM6B	HM6C	HM6D

**极限参数 / Absolute Maximum Ratings(Ta=25°C)**

参数 Parameter	符号 Symbol	数值 Rating	单位 Unit
Collector to Base Voltage	$V_{CBO}$	-50	V
Collector to Emitter Voltage	$V_{CEO}$	-45	V
Emitter to Base Voltage	$V_{EBO}$	-5.0	V
Collector Current	$I_C$	-100	mA
Collector Power Dissipation	$P_C$	400	mW
Junction Temperature	$T_j$	150	°C
Storage Temperature Range	$T_{stg}$	-55~150	°C

**电性能参数 / Electrical Characteristics(Ta=25°C)**

参数 Parameter	符号 Symbol	测试条件 Test Conditions	最小值 Min	典型值 Typ	最大值 Max	单位 Unit
Collector to Base Breakdown Voltage	$V_{CBO}$	$I_C=-0.1mA$ $I_E=0$	-50			V
Collector to Emitter Breakdown Voltage	$V_{CEO}$	$I_C=-1.0mA$ $I_B=0$	-45			V
Emitter to Base Breakdown Voltage	$V_{EBO}$	$I_E=-0.1mA$ $I_C=0$	-5.0			V
Collector Cut-Off Current	$I_{CBO}$	$V_{CB}=-50V$ $I_E=0$			-0.05	$\mu A$
Emitter Cut-Off Current	$I_{EBO}$	$V_{EB}=-5.0V$ $I_C=0$			-0.05	$\mu A$
DC Current Gain	$h_{FE}$	$V_{CE}=-5.0V$ $I_C=-1.0mA$	60		600	
Collector-Emitter Saturation Voltage	$V_{CE(sat)}$	$I_C=-100mA$ $I_B=-5.0mA$		-0.2	-0.7	V
Base-Emitter Saturation Voltage	$V_{BE(sat)}$	$I_C=-100mA$ $I_B=-5.0mA$		-0.82	-1.0	V
Base-Emitter Voltage	$V_{BE}$	$V_{CE}=-5.0V$ $I_C=-2.0mA$		-0.65	-0.75	V
Transition Frequency	$f_T$	$V_{CE}=-5.0V$ $I_C=-10mA$	100	190		MHz
Collector Output Capacitance	$C_{ob}$	$V_{CB}=-10V$ $I_E=0$ $f=1.0MHz$		4.5	7.0	pF
Noise Figure	NF	$V_{CE}=-5.0V$ $I_C=-0.2mA$ $R_g=2.0K\Omega$ $f=1.0KHz$ $\Delta f=200Hz$		0.7	10	dB

电参数曲线图 / Electrical Characteristic Curve

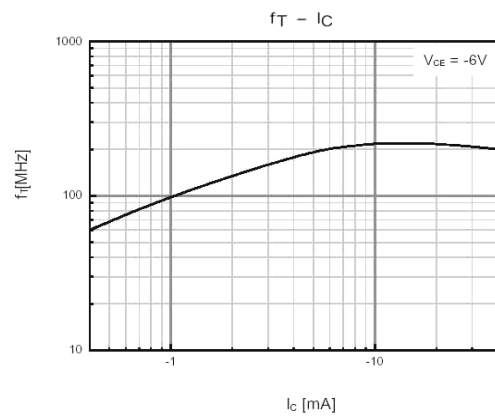
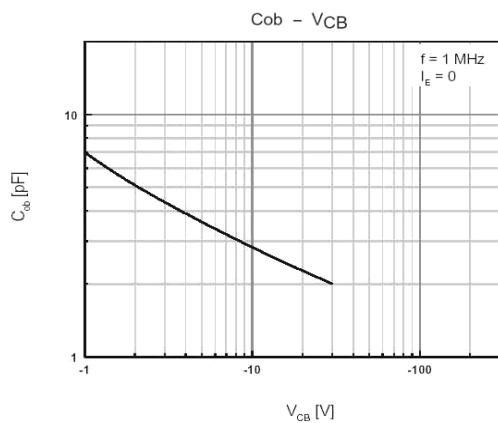
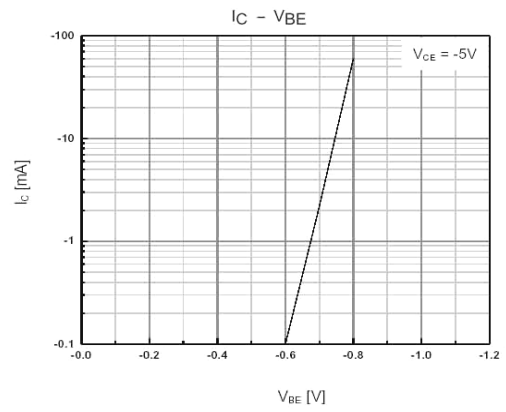
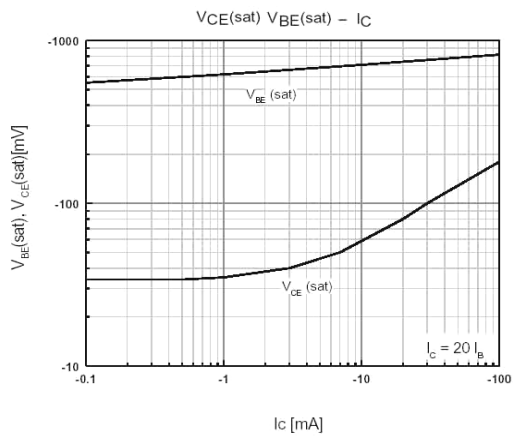
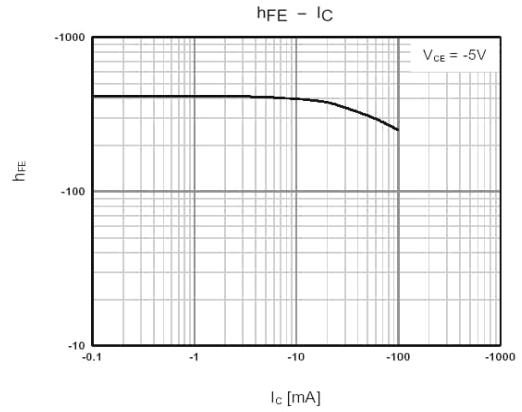
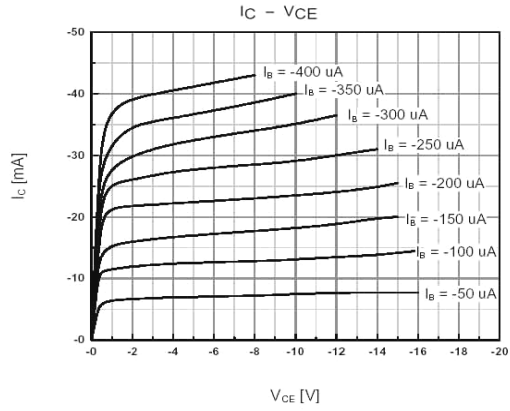

外形尺寸图 / Package Dimensions

SOT-23

单位: mm

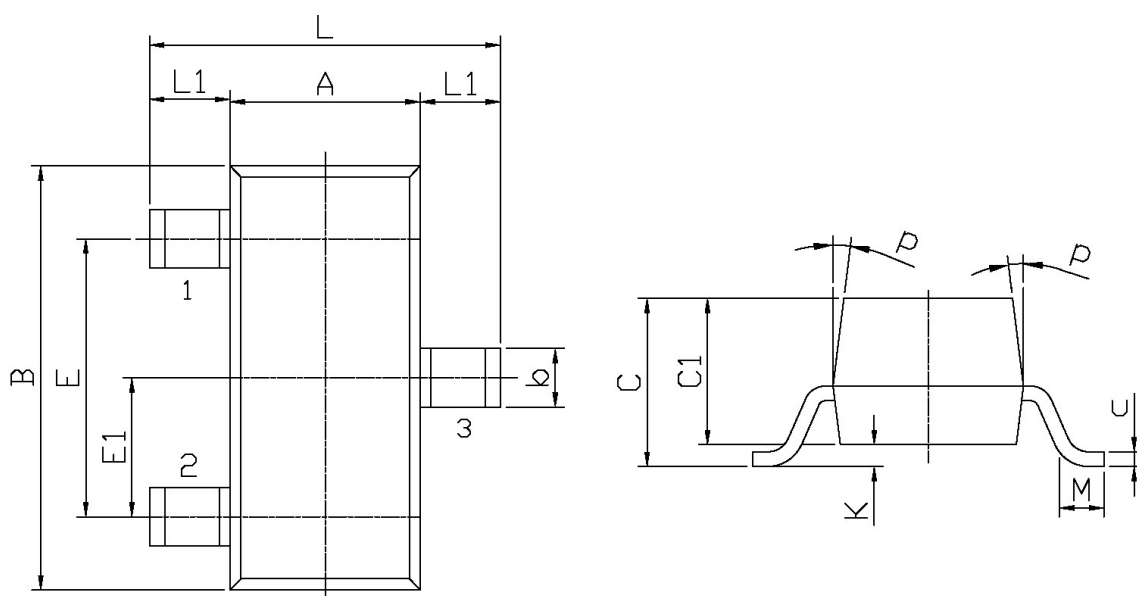

Symbol	Dimensions In Millimeters		Symbol	Dimensions In Millimeters	
	Min	Max		Min	Max
L	2.2	2.7	C	1.30Max	
L1	0.45	0.65	C1	0.90	1.20
A	1.15	1.50	c	0.05	0.20
B	2.70	3.10	K	0	0.10
E	1.70	2.10	M	0.20MIN	
E1	0.85	1.05	P	7°	
b	0.35	0.55			

印章说明 / Marking Instructions

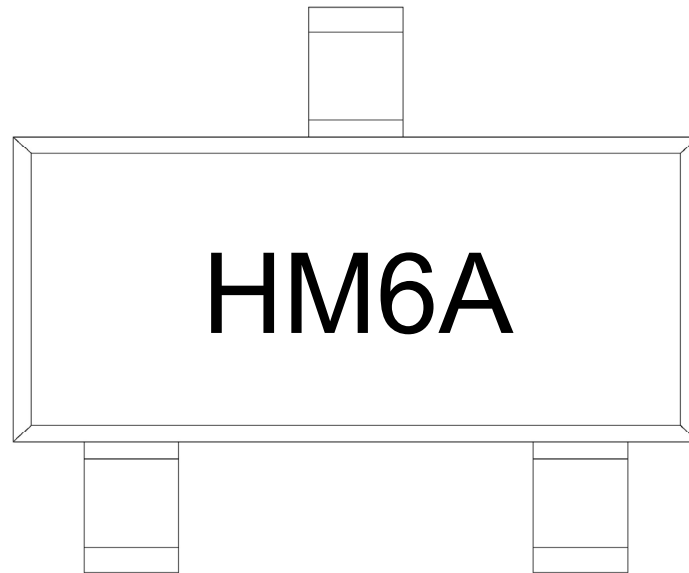

说明：

H： 为公司代码

M6： 为型号代码

A： 为  $h_{FE}$  档次代码

Note:

H： Company Code

M6： Product Type Code

A：  $h_{FE}$  Classifications Symbol Code

**回流焊温度曲线图(无铅) / Temperature Profile for IR Reflow Soldering(Pb-Free)**



说明：

- 1、预热温度 25 ~ 150°C，时间 60 ~ 90sec;
- 2、峰值温度 245±5°C，时间持续为 5±0.5sec;
- 3、焊接制程冷却速度为 2 ~ 10°C/sec.

Note:

- 1.Preheating:25~150°C, Time:60~90sec.
- 2.Peak Temp.:245±5°C, Duration:5±0.5sec.
3. Cooling Speed: 2~10°C/sec.

**耐焊接热试验条件 / Resistance to Soldering Heat Test Conditions**

温度：260±5°C

时间：10±1 sec.

Temp.:260±5°C

Time:10±1 sec

**包装规格 / Packaging SPEC.**

卷盘包装 / REEL

Package Type 封装形式	Units 包装数量					Dimension 包装尺寸 (unit: mm <sup>3</sup> )		
	Units/Reel 只/卷盘	Reels/Inner Box 卷盘/盒	Units/Inner Box 只/盒	Inner Boxes/Outer Box 盒/箱	Units/Outer Box 只/箱	Reel	Inner Box 盒	Outer Box 箱
SOT-23	3,000	10	30,000	6	180,000	7" ×8	180×120×180	390×385×205

**使用说明 / Notices**

## X-ON Electronics

Largest Supplier of Electrical and Electronic Components

*Click to view similar products for [Bipolar Transistors - BJT category](#):*

*Click to view products by [Blue Rocket manufacturer](#):*

Other Similar products are found below :

[619691C](#) [MCH4017-TL-H](#) [MMBT-2369-TR](#) [BC546/116](#) [BC557/116](#) [BSW67A](#) [NJVMJD148T4G](#) [NTE123AP-10](#) [NTE153MCP](#) [NTE16](#)  
[NTE195A](#) [NTE92](#) [C4460](#) [2N4401-A](#) [2N6728](#) [2SA1419T-TD-H](#) [2SA2126-E](#) [2SB1204S-TL-E](#) [2SC2712S-GR,LF](#) [2SC5488A-TL-H](#)  
[2SD2150T100R](#) [SP000011176](#) [2N2907A](#) [2N3904-NS](#) [2N5769](#) [2SC2412KT146S](#) [2SD1816S-TL-E](#) [CPH6501-TL-E](#) [MCH4021-TL-E](#)  
[MJE340](#) [US6T6TR](#) [NJL0281DG](#) [732314D](#) [CPH3121-TL-E](#) [CPH6021-TL-H](#) [873787E](#) [IMZ2AT108](#) [UMX21NTR](#) [MCH6102-TL-E](#)  
[NJL0302DG](#) [2N3583](#) [30A02MH-TL-E](#) [NSV40301MZ4T1G](#) [NTE13](#) [NTE26](#) [NTE282](#) [NTE323](#) [NTE350](#) [NTE81](#) [STX83003-AP](#)