

BRCS030N03ZC

Rev.C Sep.-2022

描述 / Descriptions

PDFN5×6 封装 N 沟道场效应管。
N-Channel MOSFET in a PDFN5×6 Plastic Package .

特征 / Features

低电阻可最大地降低导电损耗；低栅极电荷，可实现快速切换；低热阻；无卤产品。
Low $R_{DS(ON)}$ to minimize conductive loss; low Gate Charge for fast switching; Low Thermal resistance; HF Product.

用途 / Applications

电池管理，MB/NB/UMPC/VGA 高频负载点同步 Buck 变换器，联网直流-直流电力系统，负荷开关。
Battery Management, High Frequency Point-of-Load Synchronous Buck Converter for MB/NB/UMPC/VGA, Networking DC-DC Power System, Load Switch.

内部等效电路 / Equivalent Circuit

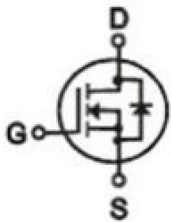

引脚排列 / Pinning

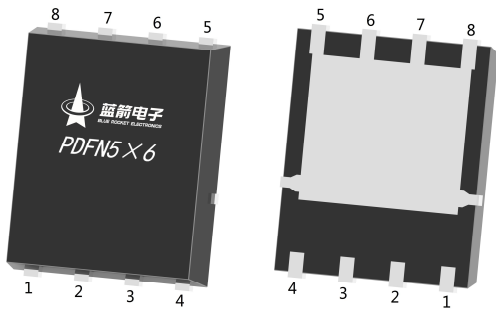

PIN1、2、3: S PIN4: G PIN5、6、7、8: D

Pin	极性
1	S
2	S
3	S
4	G
5	D
6	D
7	D
8	D

印章代码 / Marking

见印章说明。See Marking Instructions.

极限参数 / Absolute Maximum Ratings($T_a=25^{\circ}\text{C}$)

参数 Parameter	符号 Symbol	数值 Rating	单位 Unit
Drain-Source Voltage	V_{DS}	30	V
Continuous Drain Current	I_D	56	A
Pulsed Drain Current	I_{DM}	168	A
Gate-Source Voltage	V_{GS}	± 20	V
Power Dissipation	$P_D(T_c=25^{\circ}\text{C})$	33	W
Avalanche energy(L=0.5mH)	E_{AS}	72	mJ
Avalanche Current(L=0.5mH)	I_{AS}	36	A
Junction and Storage Temperature Range	T_j, T_{stg}	-55 to 150	$^{\circ}\text{C}$
Maximum Junction-to-Ambient	$t \leq 10\text{s}$	30	$^{\circ}\text{C/W}$
	Steady-State	54	
Maximum Junction-to-Case	Steady-State	3.8	

电性能参数 / Electrical Characteristics($T_a=25^{\circ}\text{C}$)

参数 Parameter	符号 Symbol	测试条件 Test Conditions	最小值 Min	典型值 Typ	最大值 Max	单位 Unit
Drain-Source Breakdown Voltage	BV_{DSS}	$I_D=250\mu\text{A}, V_{GS}=0\text{V}$	30	31		V
Zero Gate Voltage Drain Current	I_{DSS}	$V_{DS}=30\text{V}, V_{GS}=0\text{V}$			1.0	μA
Gate-Body leakage current	I_{GSS}	$V_{DS}=0\text{V}, V_{GS}=\pm 20\text{V}$			± 100	nA
Gate Threshold Voltage	$V_{GS(th)}$	$V_{DS}=V_{GS}, I_D=250\mu\text{A}$	1	1.8	2.5	V
Static Drain-Source On-Resistance	$R_{DS(ON)}$	$V_{GS}=10\text{V}, I_D=20\text{A}$		2.9	3.1	m Ω
		$V_{GS}=4.5\text{V}, I_D=10\text{A}$		4.1	4.8	
Diode Forward Voltage	V_{SD}	$I_S=1\text{A}, V_{GS}=0\text{V}$		0.68	1	V
Input Capacitance	C_{iss}	$V_{DS}=25\text{V}, V_{GS}=0\text{V}$ $f=1.0\text{MHz}$		3030		pF
Output Capacitance	C_{oss}			355		
Reverse Transfer Capacitance	C_{rss}			260		
Gate resistance	R_g	$V_{GS}=0\text{V}, V_{DS}=0\text{V}$ $f=1\text{MHz}$		3		Ω
Total Gate Charge	$Q_{g(10V)}$	$V_{GS}=10\text{V}, V_{DS}=15\text{V},$ $I_D=20\text{A}$		63		nC
Total Gate Charge	$Q_{g(4.5V)}$			29		
Gate Source Charge	Q_{gs}			9.0		
Gate Drain Charge	Q_{gd}			9.5		

电性能参数 / Electrical Characteristics(Ta=25°C)

参数 Parameter	符号 Symbol	测试条件 Test Conditions	最小值 Min	典型值 Typ	最大值 Max	单位 Unit
Turn-On Delay Time	$t_{d(on)}$	$V_{GS}=10V$ $V_{DS}=15V$ $R_L=0.75\Omega$ $R_{GEN}=3\Omega$		9		ns
Turn-On Rise Time	t_r			6		
Turn-Off Delay Time	$t_{d(off)}$			52		
Turn-Off Fall Time	t_f			11.5		

电参数曲线图 / Electrical Characteristic Curve

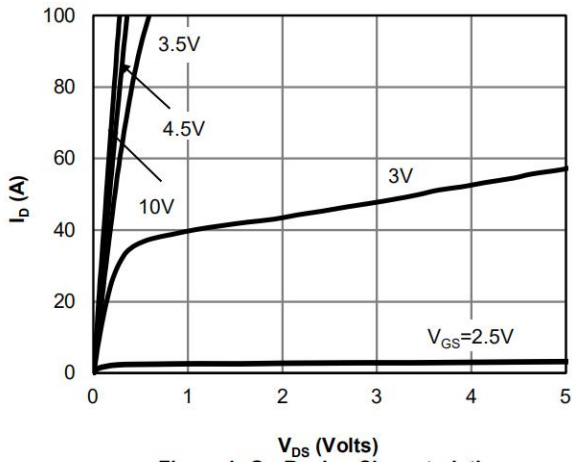

Figure 1: On-Region Characteristics

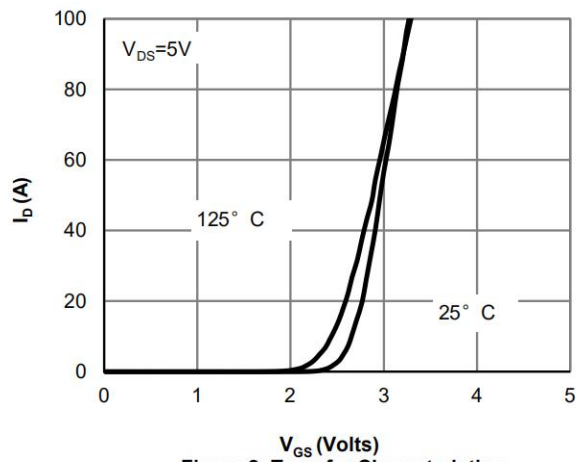

Figure 2: Transfer Characteristics

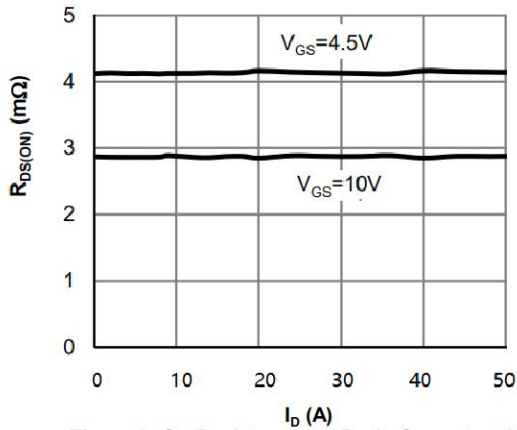

Figure 3: On-Resistance vs. Drain Current and Gate Voltage

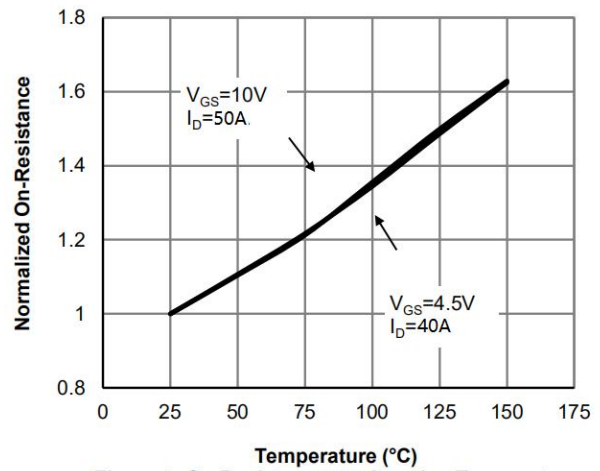

Figure 4: On-Resistance vs. Junction Temperature

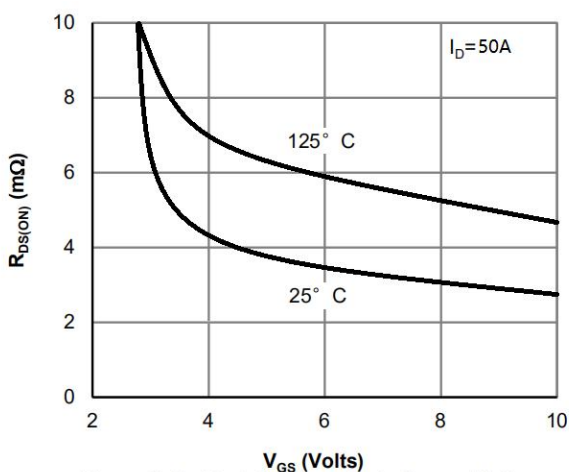

Figure 5: On-Resistance vs. Gate-Source Voltage

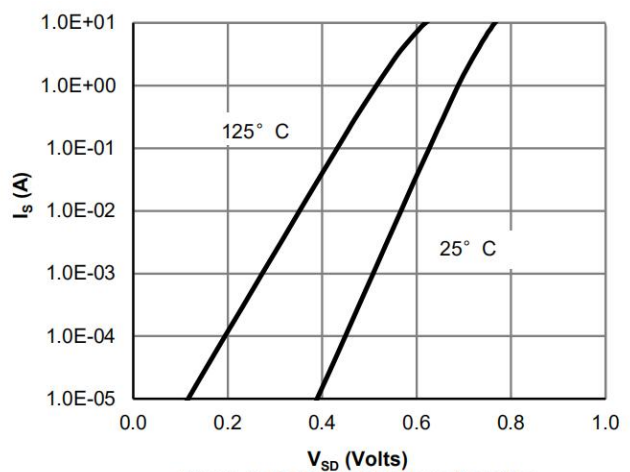

Figure 6: Body-Diode Characteristics

电参数曲线图 / Electrical Characteristic Curve

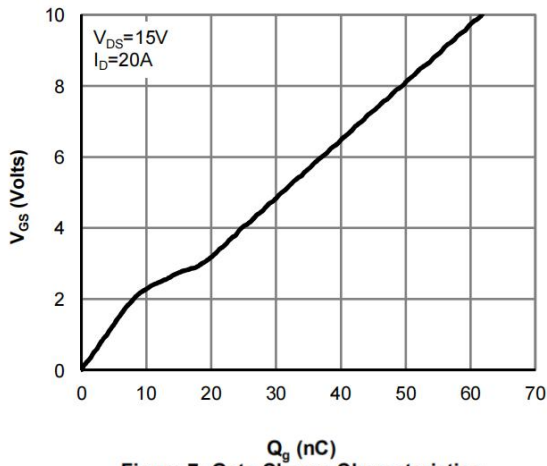

Figure 7: Gate-Charge Characteristics

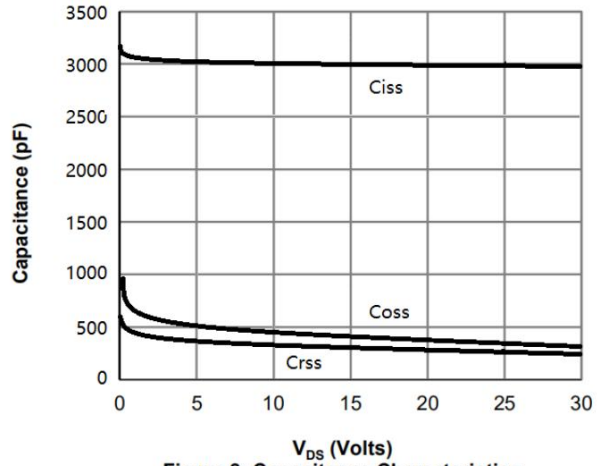

Figure 8: Capacitance Characteristics

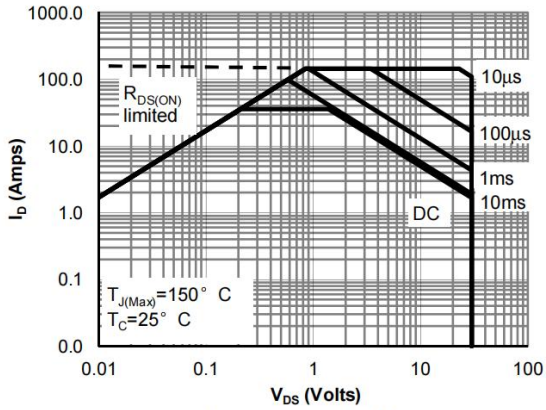

Figure 9: Maximum Forward Biased Safe Operating Area
V_{GS} > or equal to 4.5V

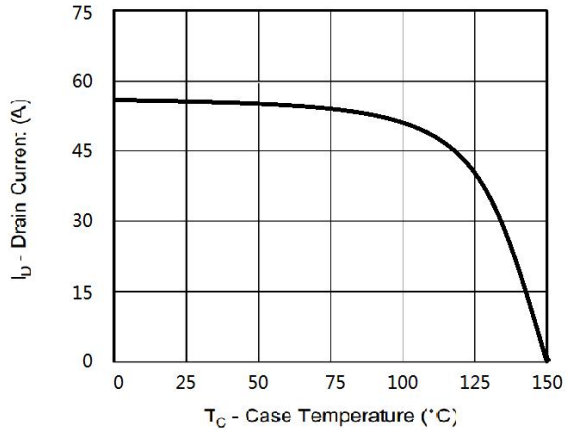

Figure 10: Maximum Continuous Drain Current vs Case Temperature

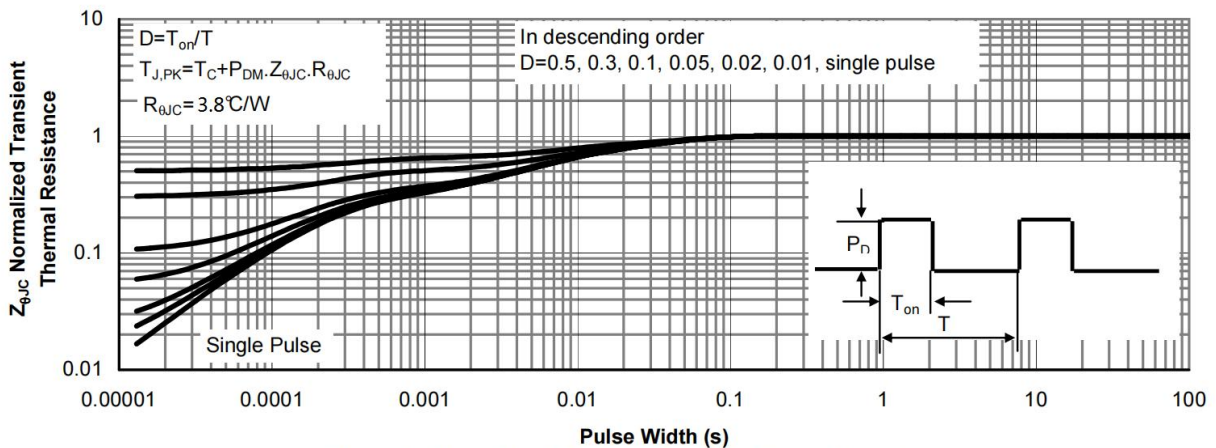
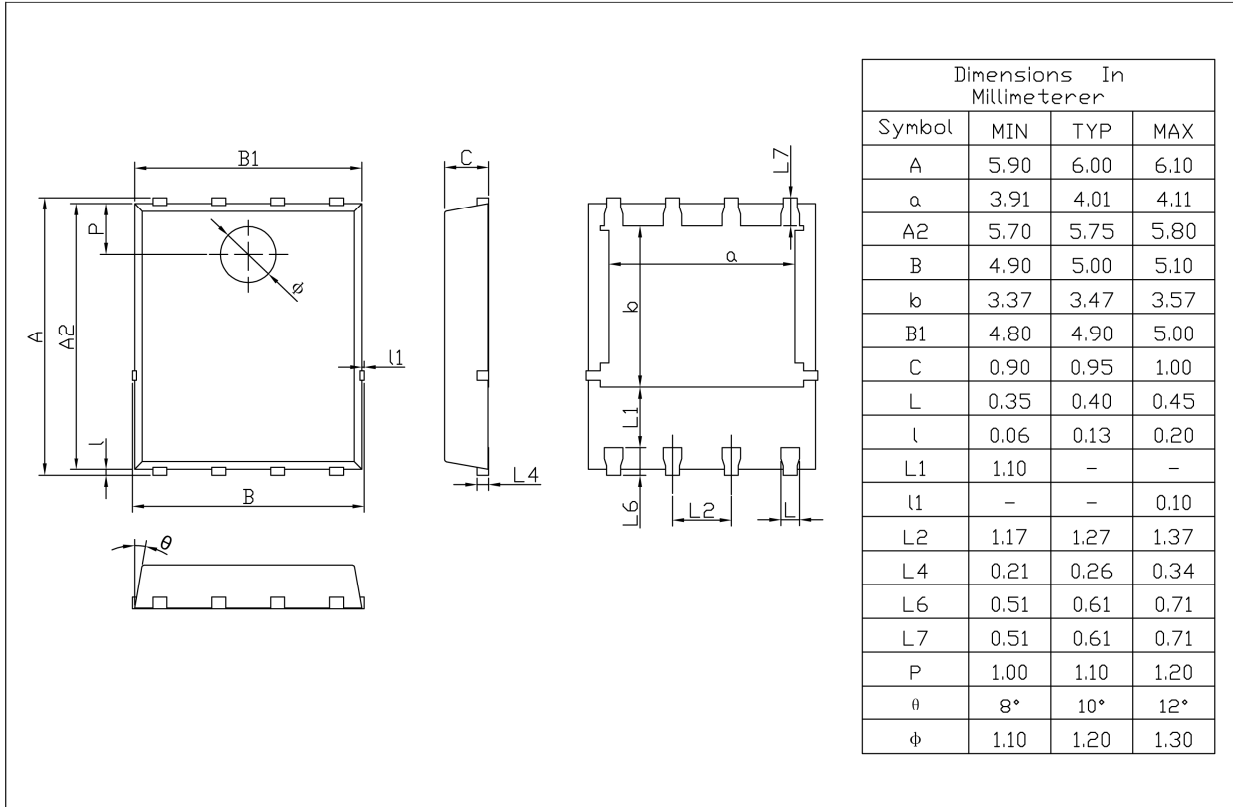

Figure 10: Normalized Maximum Transient Thermal Impedance

外形尺寸图 / Package Dimensions

PDFN5 X6

Unit:mm



Rev.00 201812

印章说明 / Marking Instructions

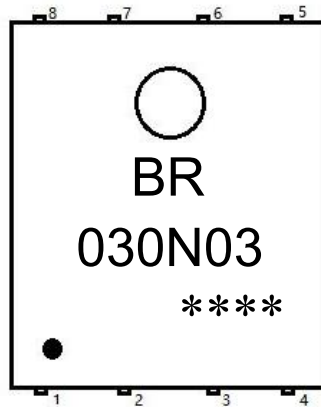

说明：

BR： 为公司代码

030N03： 为产品型号

****： 为生产批号代码，随生产批号变化

Note：

BR： Company Code

030N03： Product Type

****: Lot No. Code, code change with Lot No

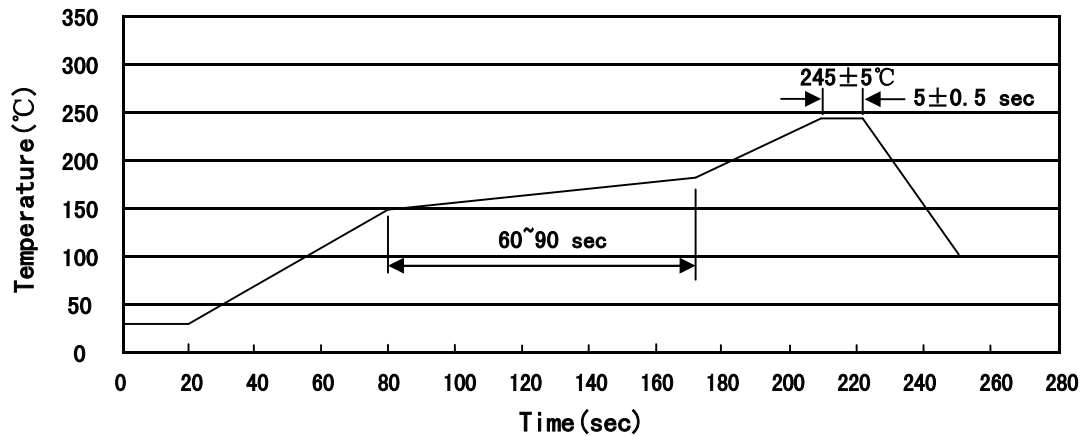
回流焊温度曲线图(无铅) / Temperature Profile for IR Reflow Soldering(Pb-Free)

说明：

- 1、预热温度 150~180°C，时间 60~90sec;
- 2、峰值温度 245±5°C，时间持续为 5±0.5sec;
- 3、焊接制程冷却速度为 2~10°C/sec.

Note:

- 1.Preheating:150~180°C, Time:60~90sec.
- 2.Peak Temp.:245±5°C, Duration:5±0.5sec.
3. Cooling Speed: 2~10°C/sec.

耐焊接热试验条件 / Resistance to Soldering Heat Test Conditions

温度：260±5°C

时间：10±1 sec.

Temp.:260±5°C

Time:10±1 sec

包装规格 / Packaging SPEC.

卷盘包装 / REEL

Package Type 封装形式	Units 包装数量					Dimension 包装尺寸 (unit: mm ³)		
	Units/Reel 只/卷盘	Reels/Inner Box 卷盘/盒	Units/Inner Box 只/盒	Inner Boxes/Outer Box 盒/箱	Units/Outer Box 只/箱	Reel	Inner Box 盒	Outer Box 箱
PDFN5×6	5000	2	10000	6	60000	13"×12	360×360×50	380×335×366

使用说明 / Notices

X-ON Electronics

Largest Supplier of Electrical and Electronic Components

Click to view similar products for [MOSFET](#) category:

Click to view products by [Blue Rocket](#) manufacturer:

Other Similar products are found below :

[IRFD120](#) [JANTX2N5237](#) [BUK455-60A/B](#) [MIC4420CM-TR](#) [VN1206L](#) [NDP4060](#) [SI4482DY](#) [IPS70R2K0CEAKMA1](#) [SQD23N06-31L-GE3](#)
[TK16J60W,S1VQ\(O](#) [2SK2614\(TE16L1,Q\)](#) [DMN1017UCP3-7](#) [DMN1053UCP4-7](#) [SQJ469EP-T1-GE3](#) [NTE2384](#) [DMC2700UDMQ-7](#)
[DMN2080UCB4-7](#) [DMN61D9UWQ-13](#) [US6M2GTR](#) [DMN31D5UDJ-7](#) [DMP22D4UFO-7B](#) [DMN1006UCA6-7](#) [DMN16M9UCA6-7](#)
[STF5N65M6](#) [IRF40H233XTMA1](#) [STU5N65M6](#) [DMN6022SSD-13](#) [DMN13M9UCA6-7](#) [DMTH10H4M6SPS-13](#) [DMN2990UFB-7B](#)
[IPB80P04P405ATMA2](#) [2N7002W-G](#) [MCAC30N06Y-TP](#) [MCQ7328-TP](#) [NTMC083NP10M5L](#) [BXP7N65D](#) [BXP4N65F](#) [AOL1454G](#)
[WMJ80N60C4](#) [BXP2N20L](#) [BXP2N65D](#) [BXT1150N10J](#) [BXT1700P06M](#) [TSM60NB380CP](#) [ROG](#) [RQ7L055BGTGR](#) [DMNH15H110SK3-13](#)
[SLF10N65ABV2](#) [BSO203SP](#) [BSO211P](#) [IPA60R230P6](#)