

# BRCS030N04DP

Rev.A Feb.-2023

## 描述 / Descriptions

TO-252 塑封封装 N 沟道场效应管。

N-CHANNEL MOSFET in a TO-252 Plastic Package.

## 特征 / Features

$R_{DS(on)}$ 小, 门电荷低,  $C_{rss}$ 小, 开关速度快, 无卤产品。

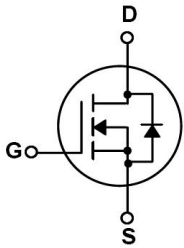
Low  $R_{DS(on)}$ , low gate charge, low  $C_{rss}$ , fast switching, HF Product.

## 用途 / Applications

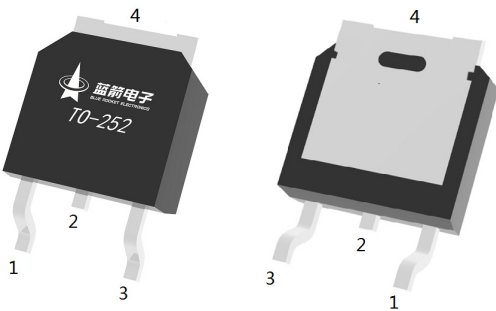
用于低压电路如: 汽车电路、DC/DC 转换、便携式产品的电源高效转换, 满足汽车应用的严格要求。

Suited for low voltage applications such as automotive, DC/DC Converters, and high efficiency switching for power management in portable and battery operated products, Meet the stringent requirements of automotive applications.

## 内部等效电路 / Equivalent Circuit



## 引脚排列 / Pinning



PIN1 : G

PIN 2 : D

PIN 3 : S

PIN 4 : D

## 印章代码 / Marking

见印章说明。

See Marking Instructions.

**极限参数 / Absolute Maximum Ratings(Ta=25°C)**

参数 Parameter	符号 Symbol	数值 Rating	单位 Unit
Drain-Source Voltage	$V_{DSS}$	40	V
Drain Current	$I_D(T_C=25^\circ C)$	150	A
Drain Current - Pulsed	$I_{DM}$	304	A
Gate-Source Voltage	$V_{GS}$	$\pm 20$	V
Avalanche Current	$I_{AS}$	33	A
Single Pulsed Avalanche Energy(L=0.5mH)	$E_{AS}$	435	mJ
Power Dissipation	$P_D(T_C=25^\circ C)$	120	W
Junction and Storage Temperature Range	$T_J, T_{STG}$	-55 to 150	$^\circ C$
Thermal Resistance-Junction to Ambient	$t \leq 10s$	$R_{\theta JA}$	$^\circ C/W$
	Steady-State		
Thermal Resistance-Junction to Case	Steady-State	$R_{\theta JC}$	1.04

**电性能参数 / Electrical Characteristics(Ta=25°C)**

参数 Parameter	符号 Symbol	测试条件 Test Conditions	最小值 Min	典型值 Typ	最大值 Max	单位 Unit
Drain-Source Breakdown Voltage	$BV_{DSS}$	$V_{GS}=0V$ $I_D=250\mu A$	40			V
Zero Gate Voltage Drain Current	$I_{DSS}$	$V_{DS}=40V$ $V_{GS}=0V$			1.0	$\mu A$
Gate-Body Leakage Current Forward	$I_{GSS}$	$V_{GS}=\pm 20V$ $V_{DS}=0V$			$\pm 100$	nA
Gate Threshold Voltage	$V_{GS(th)}$	$V_{DS}=V_{GS}$ $I_D=250\mu A$	1.0	1.7	2.5	V
Static Drain-Source On-Resistance	$R_{DS(on)}$	$V_{GS}=10V$ $I_D=20A$		2.5	3.0	m $\Omega$
		$V_{GS}=4.5V$ $I_D=10A$		3.1	5.0	
Drain-Source Diode Forward Voltage	$V_{SD}$	$V_{GS}=0V$ $I_S=1A$			1.4	V
Gate resistance	$R_g$	$V_{GS}=0V$ $f=1MHz$ $V_{DS}=0V,$		1.16		$\Omega$
Input Capacitance	$C_{iss}$	$V_{DS}=25V$ $V_{GS}=0V$ $f=1.0MHz$		9600		pF
Output Capacitance	$C_{oss}$			740		
Reverse Transfer Capacitance	$C_{rss}$			650		
Total Gate Charge	$Q_{g(10V)}$	$V_{GS}=10V,$ $V_{DS}=20V,$ $I_D=20A$		51		nC
Total Gate Charge	$Q_{g(4.5V)}$			23		
Gate Source Charge	$Q_{gs}$			13.2		
Gate Drain Charge	$Q_{gd}$			3.1		

## 电性能参数 / Electrical Characteristics(Ta=25°C)

参数 Parameter	符号 Symbol	测试条件 Test Conditions	最小值 Min	典型值 Typ	最大值 Max	单位 Unit
Turn-On Delay Time	$t_{d(on)}$	$V_{GS}=10V$ $V_{DS}=20V$ $R_L=1\ \Omega$ $R_{GEN}=3\ \Omega$		11		ns
Turn-On Rise Time	$t_r$			11		
Turn-Off Delay Time	$t_{d(off)}$			40		
Turn-Off Fall Time	$t_f$			10		

电参数曲线图 / Electrical Characteristic Curve

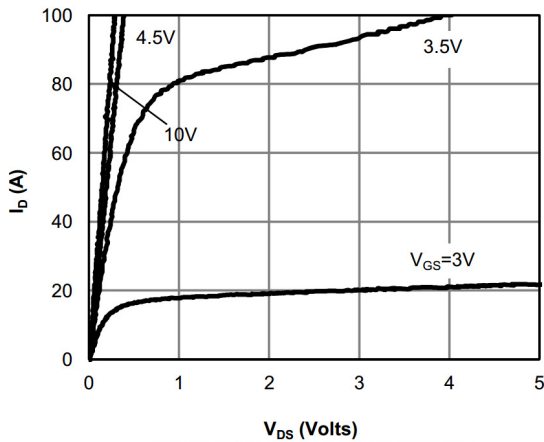


Figure 1: On-Region Characteristics

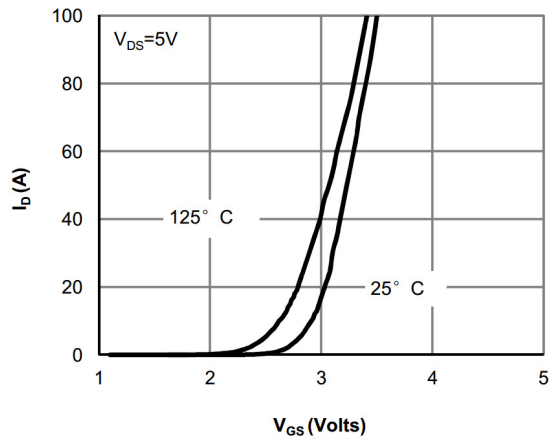


Figure 2: Transfer Characteristics

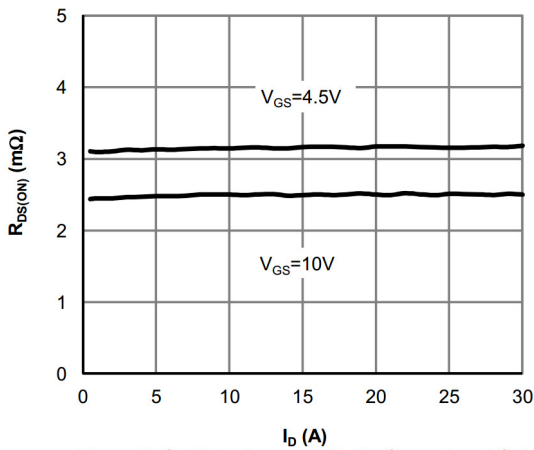


Figure 3: On-Resistance vs. Drain Current and Gate Voltage

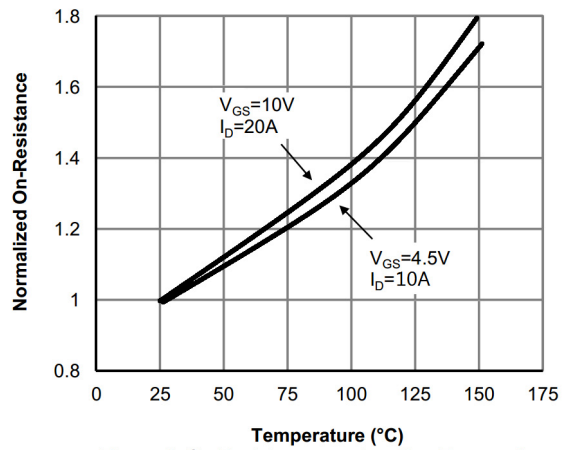


Figure 4: On-Resistance vs. Junction Temperature

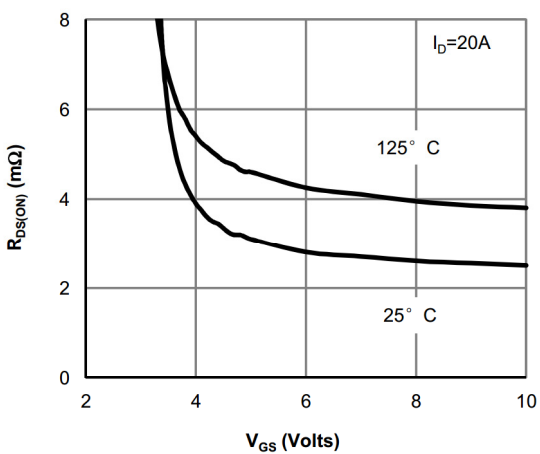


Figure 5: On-Resistance vs. Gate-Source Voltage

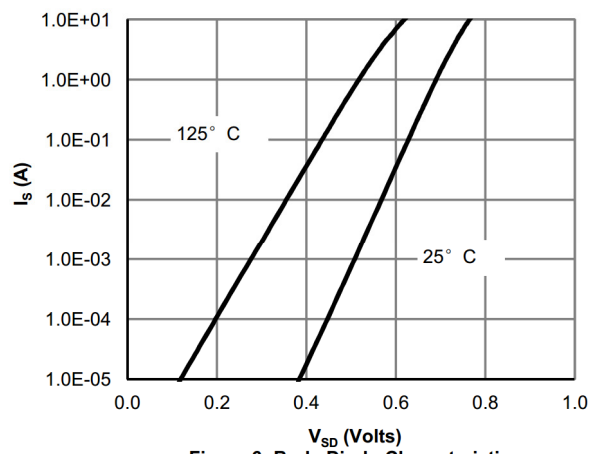
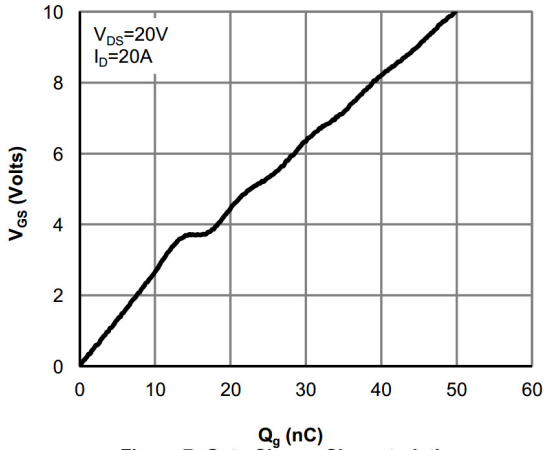
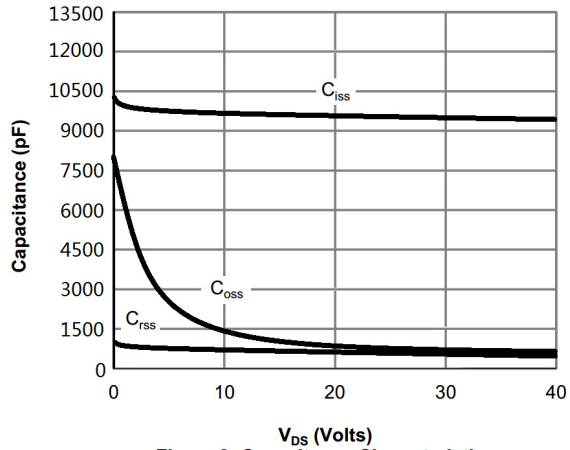


Figure 6: Body-Diode Characteristics

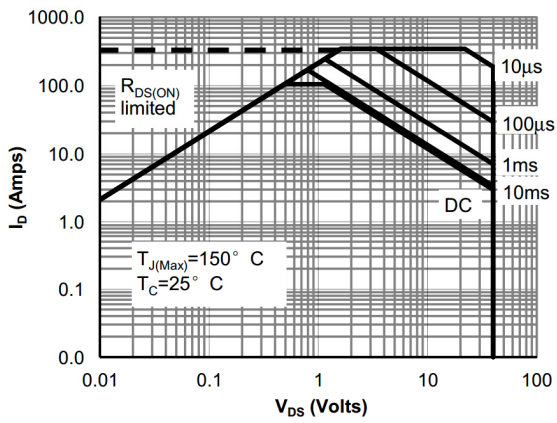
**电参数曲线图 / Electrical Characteristic Curve**



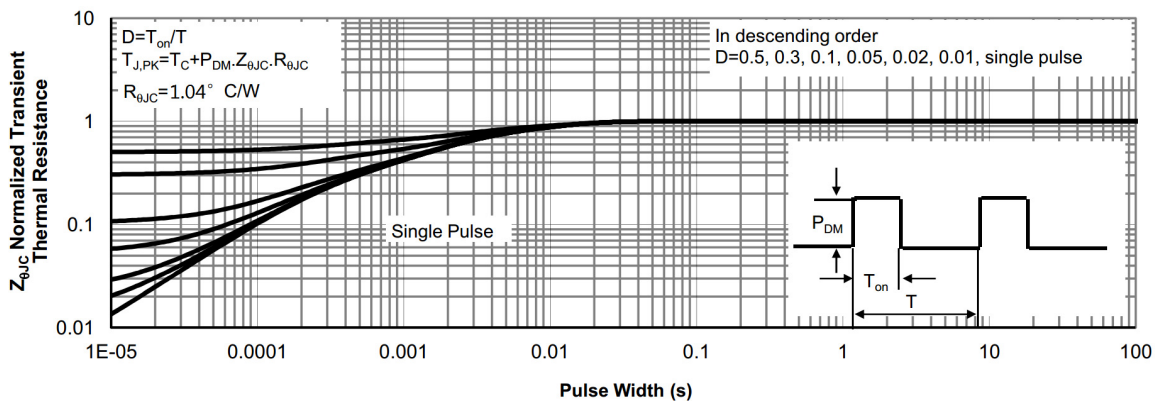
**Figure 7: Gate-Charge Characteristics**



**Figure 8: Capacitance Characteristics**

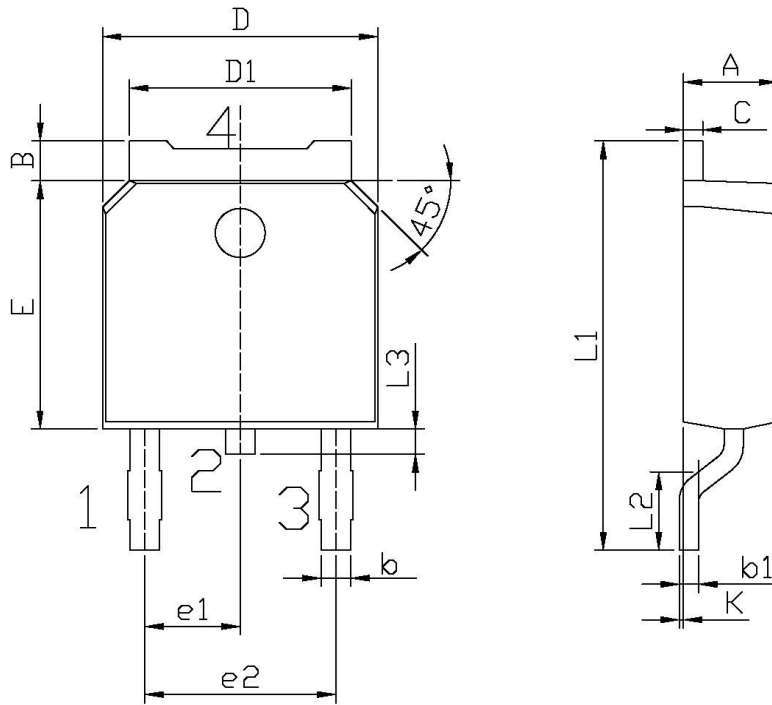


**Figure 9: Maximum Forward Biased Safe Operating Area**



**Figure 10: Normalized Maximum Transient Thermal Impedance**

**外形尺寸图 / Package Dimensions**

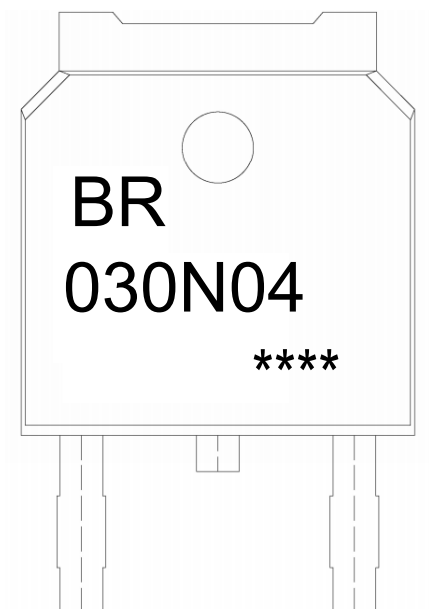


单位: mm

Symbol	Dimensions In Millimeters		Symbol	Dimensions In Millimeters	
	Min	Max		Min	Max
A	2.20	2.40	E	5.95	6.25
B	0.95	1.25	e1	2.24	2.34
b	0.70	0.90	e2	4.43	4.73
b1	0.45	0.55	L1	9.85	10.35
C	0.45	0.55	L2	1.70	2.00
D	6.45	6.75	L3	0.60	0.90
D1	5.10	5.50	K	0.00	0.10

TO-252

**印章说明 / Marking Instructions**



说明：

BR： 为公司代码

030N04： 为型号代码

\*\*\*\*： 为生产批号代码，随生产批号变化

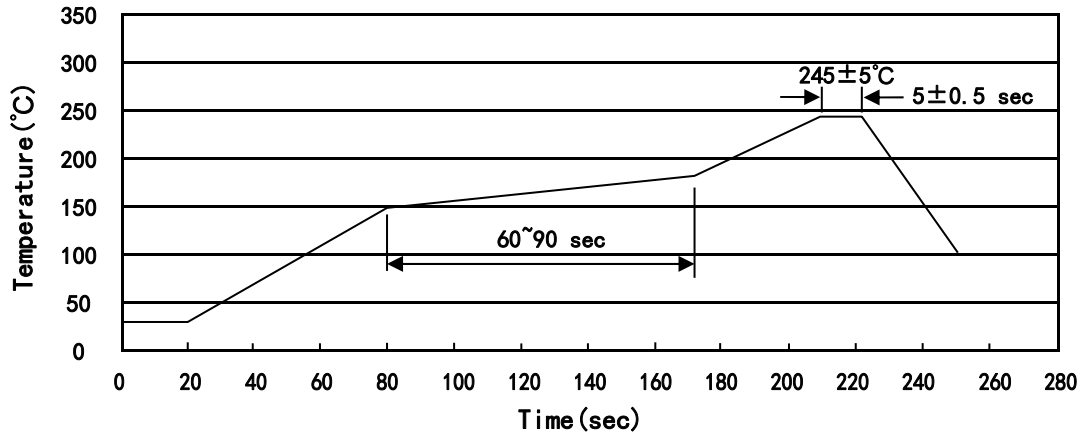
Note:

BR: Company Code

030N04: Product Type Code

\*\*\*\*: Lot No. Code, code change with Lot No

**回流焊温度曲线图(无铅) / Temperature Profile for IR Reflow Soldering(Pb-Free)**



说明：

- 1、预热温度 150 ~ 180°C，时间 60 ~ 90sec；
- 2、峰值温度 245±5°C，时间持续为 5±0.5sec；
- 3、焊接制程冷却速度为 2 ~ 10°C/sec.

Note:

- 1.Preheating:150~180°C, Time:60~90sec.
- 2.Peak Temp.:245±5°C, Duration:5±0.5sec.
3. Cooling Speed: 2~10°C/sec.

**耐焊接热试验条件 / Resistance to Soldering Heat Test Conditions**

温度：260±5°C

时间：10±1 sec.

Temp.:260±5°C

Time:10±1 sec

**包装规格 / Packaging SPEC.**

卷盘包装 / REEL

Package Type 封装形式	Units 包装数量					Dimension 包装尺寸 (unit: mm <sup>3</sup> )		
	Units/Reel 只/卷盘	Reels/Inner Box 卷盘/盒	Units/Inner Box 只/盒	Inner Boxes/Outer Box 盒/箱	Units/Outer Box 只/箱	Reel	Inner Box 盒	Outer Box 箱
TO-252	2,500	2	5,000	6	30,000	13" × 16	360×360×50	380×335×366

套管包装 / TUBE

Package Type 封装形式	Units 包装数量					Dimension 包装尺寸 (unit: mm <sup>3</sup> )		
	Units/Tube 只/套管	Tubes/Inner Box 套管/盒	Units/Inner Box 只/盒	Inner Boxes/Outer Box 盒/箱	Units/Outer Box 只/箱	Tube 套管	Inner Box 盒	Outer Box 箱
TO-251/252	75	48	3,600	5	18,000	526×20.5×5.25	555×164×50	575×290×180

**使用说明 / Notices**



## X-ON Electronics

Largest Supplier of Electrical and Electronic Components

*Click to view similar products for [MOSFET](#) category:*

*Click to view products by [Blue Rocket](#) manufacturer:*

Other Similar products are found below :

[IRFD120](#) [JANTX2N5237](#) [BUK455-60A/B](#) [MIC4420CM-TR](#) [VN1206L](#) [NDP4060](#) [SI4482DY](#) [IPS70R2K0CEAKMA1](#) [SQD23N06-31L-GE3](#)  
[TK16J60W,S1VQ\(O](#) [2SK2614\(TE16L1,Q\)](#) [DMN1017UCP3-7](#) [DMN1053UCP4-7](#) [SQJ469EP-T1-GE3](#) [NTE2384](#) [DMC2700UDMQ-7](#)  
[DMN2080UCB4-7](#) [DMN61D9UWQ-13](#) [US6M2GTR](#) [DMN31D5UDJ-7](#) [DMP22D4UFO-7B](#) [DMN1006UCA6-7](#) [DMN16M9UCA6-7](#)  
[STF5N65M6](#) [IRF40H233XTMA1](#) [STU5N65M6](#) [DMN6022SSD-13](#) [DMN13M9UCA6-7](#) [DMTH10H4M6SPS-13](#) [DMN2990UFB-7B](#)  
[IPB80P04P405ATMA2](#) [2N7002W-G](#) [MCAC30N06Y-TP](#) [MCQ7328-TP](#) [NTMC083NP10M5L](#) [NVMFS2D3P04M8LT1G](#) [BXP7N65D](#)  
[BXP4N65F](#) [AOL1454G](#) [WMJ80N60C4](#) [BXP2N20L](#) [BXP2N65D](#) [BXT1150N10J](#) [BXT1700P06M](#) [TSM60NB380CP](#) [ROG](#) [RQ7L055BGTCR](#)  
[DMNH15H110SK3-13](#) [SLF10N65ABV2](#) [BSO203SP](#) [BSO211P](#)