

BRCS100N06RA

Rev.C Jul.-2018

描述 / Descriptions

TO-220 塑封封装 N 沟道 MOS 场效应管。N-CHANNEL MOSFET in a TO-220 Plastic Package.

特征 / Features

低栅电荷,低反馈电容,开关速度快。

Low gate charge, low crss, fast switching.

用途 / Applications

用于高功率 DC/DC 转换和功率开关。

These devices are well suited for high efficiency switching DC/DC converters and switch mode power supplies.

内部等效电路 / Equivalent Circuit

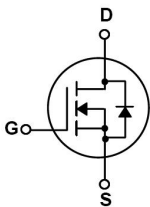

引脚排列 / Pinning

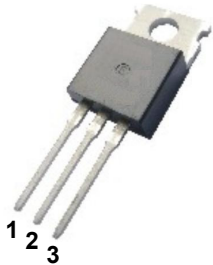

PIN1 : G

PIN 2 : D

PIN 3 : S

放大及印章代码 / h_{FE} Classifications & Marking

见印章说明。 See Marking Instructions.

极限参数 / Absolute Maximum Ratings(Ta=25°C)

参数 Parameter	符号 Symbol	数值 Rating	单位 Unit
Drain-Source Voltage	V_{DSS}	60	V
Drain Current	$I_D(T_c=25^\circ C)$	100	A
Peak Drain Current	I_{DM}	380	A
Gate-Source Voltage	V_{GSS}	± 20	V
Single Pulsed Avalanche Energy	E_{AS}	1.29	J
Avalanche Current	I_{AR}	58.6	A
Total Power Dissipation	$P_D(T_c=25^\circ C)$	100	W
Junction and Storage Temperature Range	T_J, T_{STG}	-55 to 150	$^\circ C$

电性能参数 / Electrical Characteristics(Ta=25°C)

参数 Parameter	符号 Symbol	测试条件 Test Conditions	最小值 Min	典型值 Typ	最大值 Max	单位 Unit
Zero Gate Voltage Drain Current	BV_{DSS}	$V_{GS}=0V$ $I_D=250\mu A$	60			V
Zero Gate Voltage Drain Current	I_{DSS}	$V_{DS}=60V$ $V_{GS}=0V$			1	μA
		$V_{DS}=60V$ $V_{GS}=0V$ $T_J=85^\circ C$			30	μA
Gate-Body Leakage Current Forward	I_{GSS}	$V_{GS}=\pm 20V$ $V_{DS}=0V$			± 100	nA
Gate Threshold Voltage	$V_{GS(th)}$	$V_{DS}=V_{GS}$ $I_D=250\mu A$	2.0		4.0	V
Forward On Voltage	V_{SD}	$I_S=90A$ $V_{GS}=0V$			1.2	V
Static Drain-Source On-Resistance	$R_{DS(on)}$	$V_{GS}=10V$ $I_D=90A$		8.0	10	m Ω
Gate Resistance	R_G	$V_{GS}=0V$ $V_{DS}=0V$ Frequency=1MHz		1.7		Ω
Input Capacitance	C_{iss}	$V_{GS}=0V$ $f=1.0MHz$ $V_{DS}=25V$		3160		pF
Output Capacitance	C_{oss}			752		pF
Reverse Transfer Capacitance	C_{rss}			190		pF
Total Gate Charge	Q_G	$V_{DS}=30V$ $V_{GS}=10V$ $I_D=60A$		96		nC
Gate Source Charge	Q_{GS}			21		nC
Gate Drain Charge	Q_{GD}			23		nC
Turn-On Delay Time	$t_{d(on)}$	$V_{DD}=30V$ $I_D=60A$ $R_{GEN}=6\Omega$ $V_{GS}=10V$		13	26	ns
Turn-On Rise Time	t_r			11	20	ns
Turn-Off Delay Time	$t_{d(off)}$			40	66	ns
Turn-Off Fall Time	t_f			60	95	ns

电参数曲线图 / Electrical Characteristic Curve

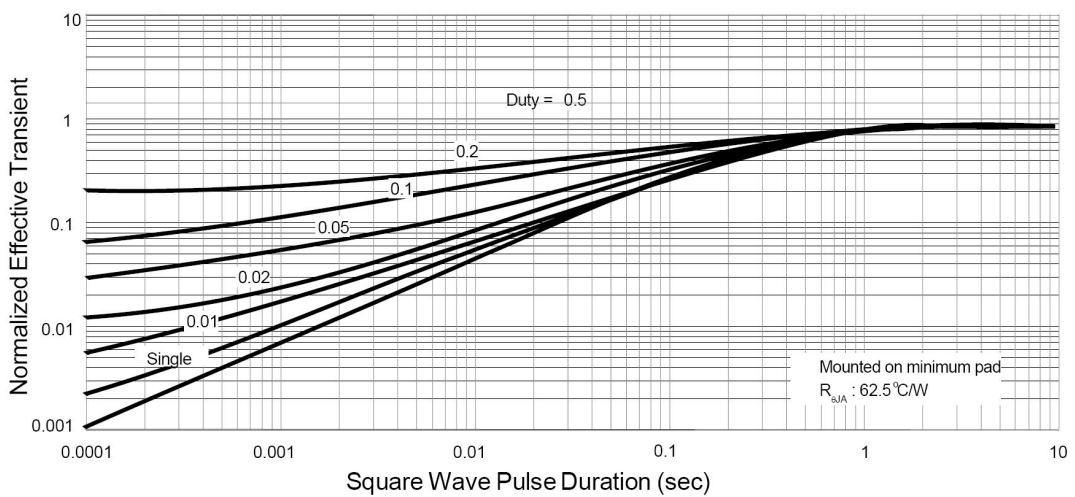
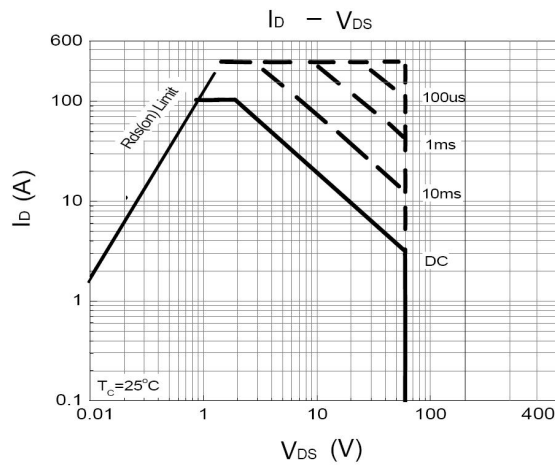
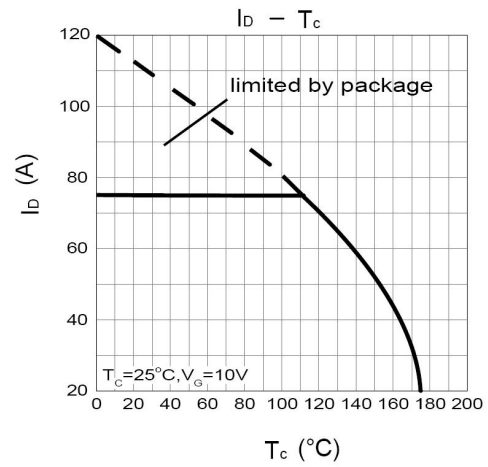
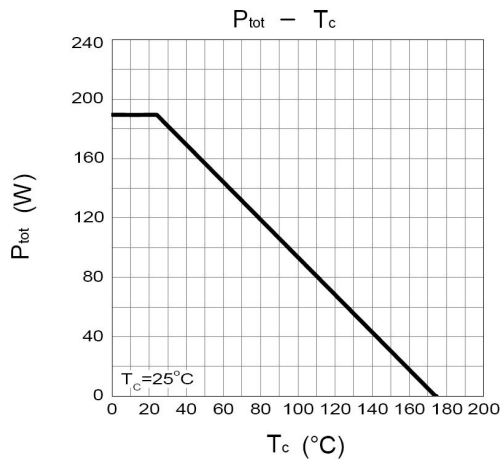

电参数曲线图 / Electrical Characteristic Curve

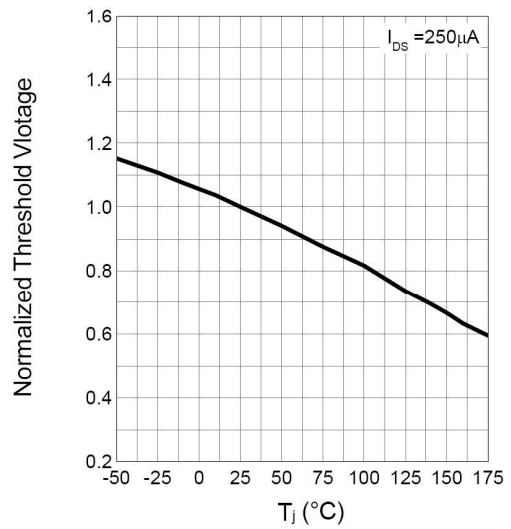
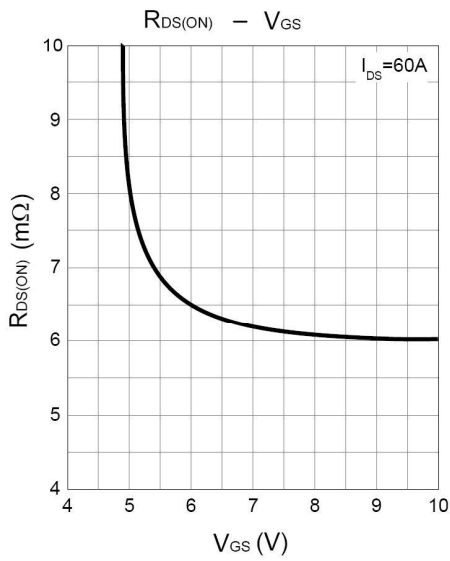
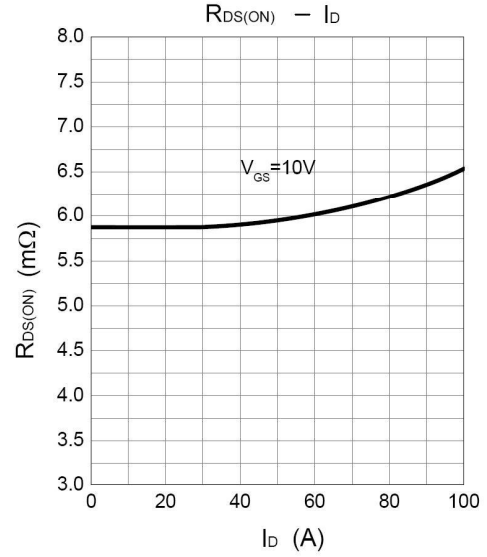
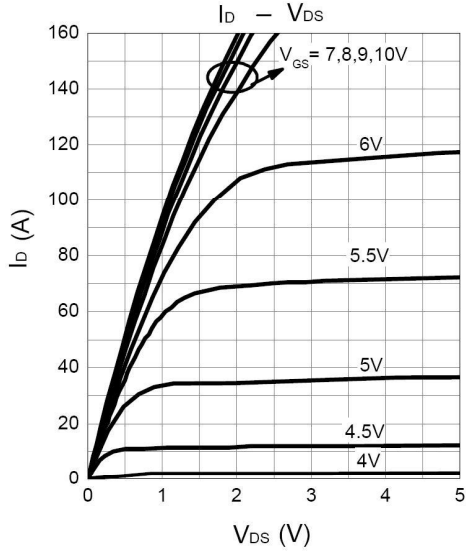

电参数曲线图 / Electrical Characteristic Curve

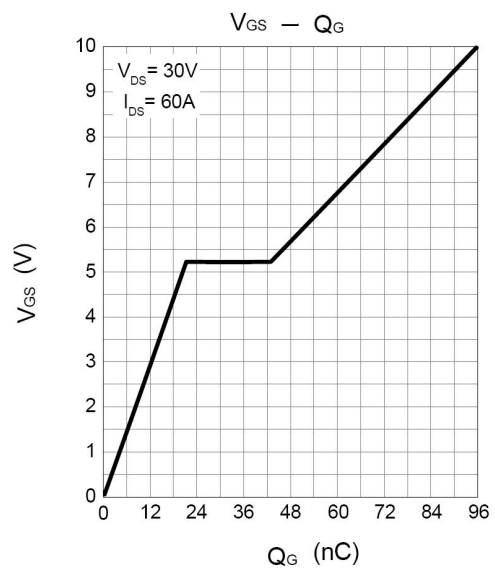
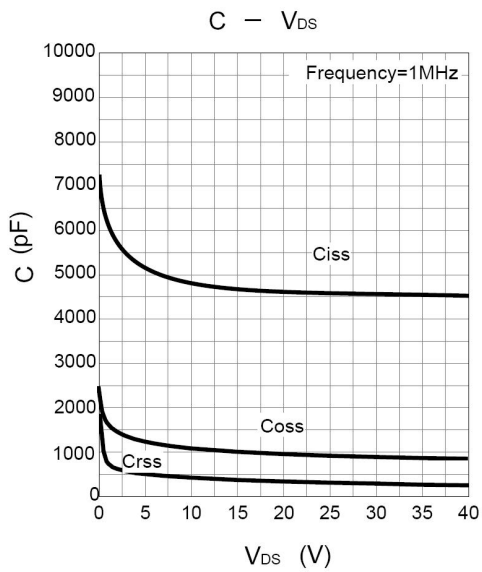
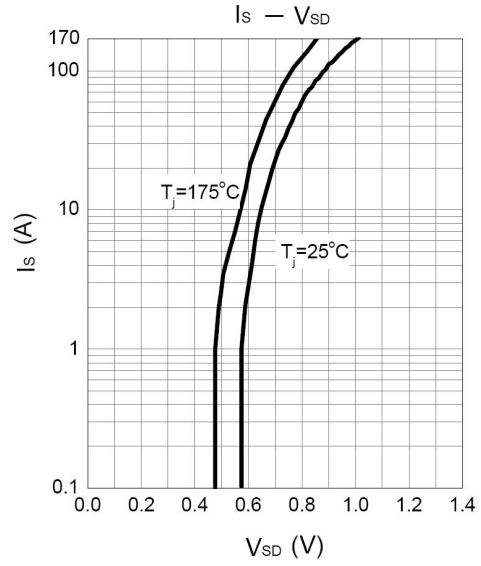
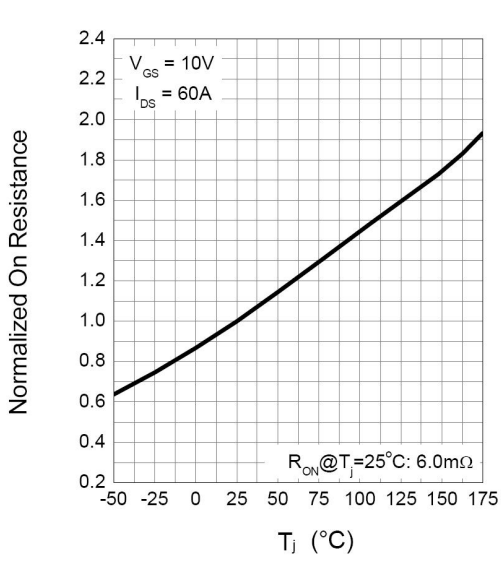

测试电路和波形 / Test Circuit and Waveforms

Avalanche Test Circuit and Waveforms

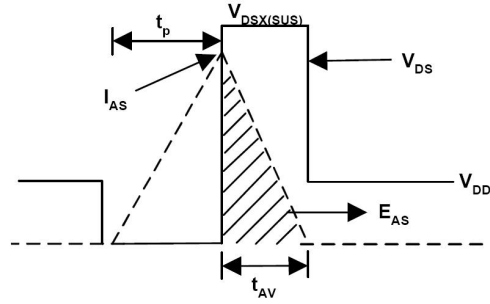
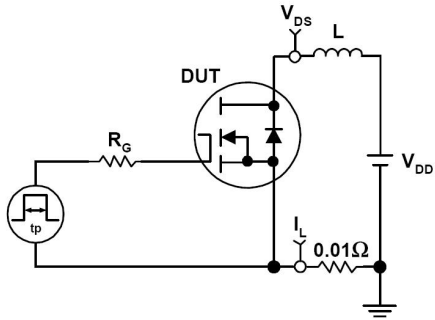

Avalanche Test Circuit and Waveforms

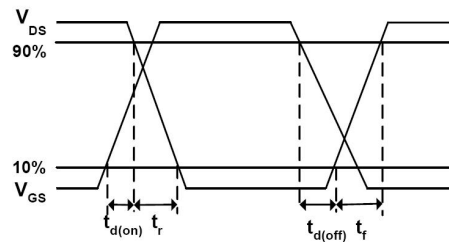
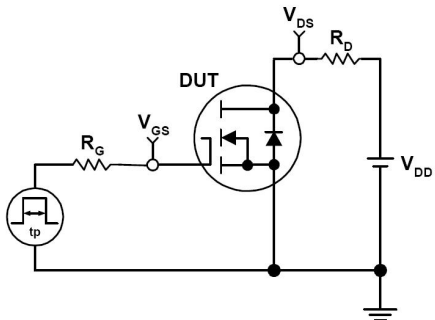

外形尺寸图 / Package Dimensions

T□-220

单位: mm

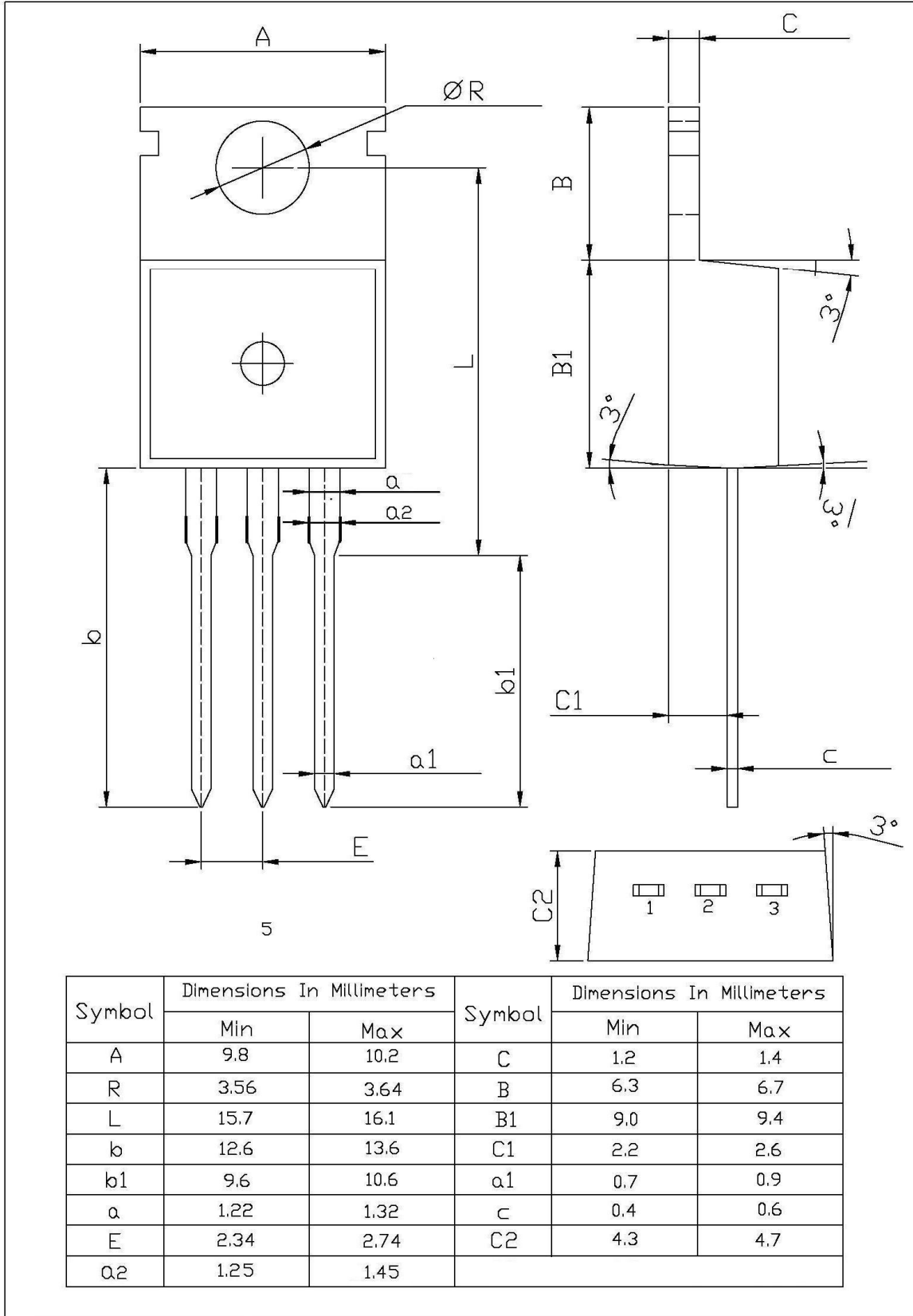

印章说明 / Marking Instructions

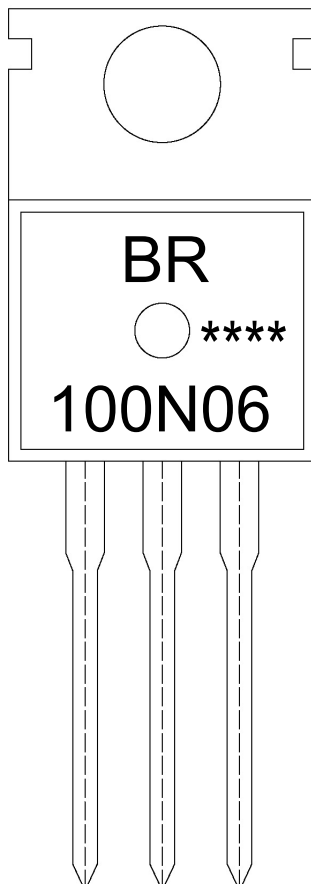

说明：

BR： 为公司代码

100N06： 为型号代码

****： 为生产批号代码，随生产批号变化。

Note:

BR: Company Code

100N06: Product Type.

****: Lot No. Code, code change with Lot No.

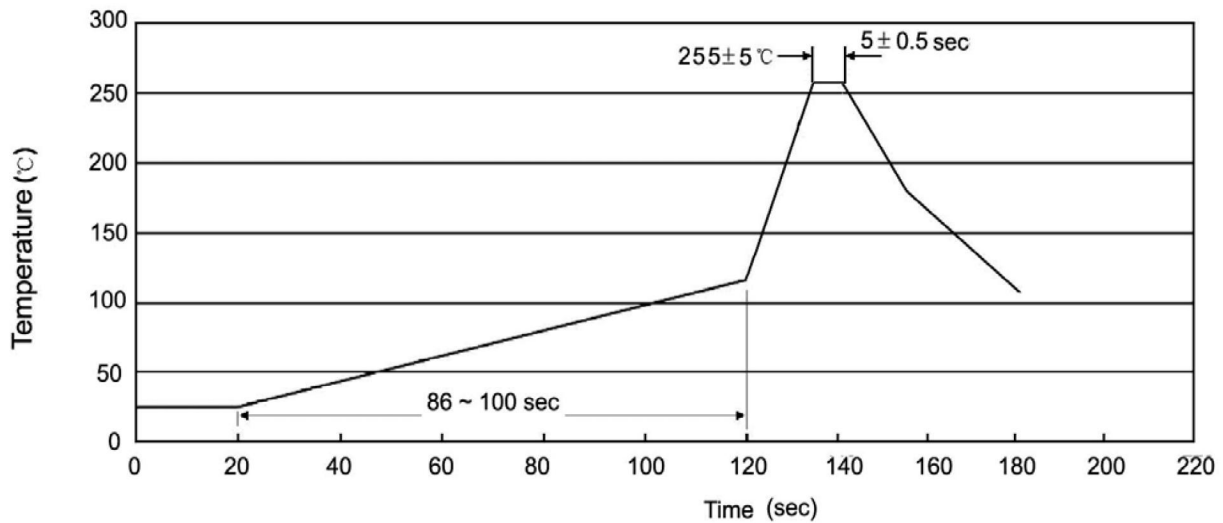
波峰焊温度曲线图(无铅) / Temperature Profile for Dip Soldering(Pb-Free)

说明：

- 1、预热温度 25 ~ 150°C，时间 60 ~ 90sec；
- 2、峰值温度 255±5°C，时间持续为 5±0.5sec；
- 3、焊接制程冷却速度为 2 ~ 10°C/sec.

Note:

- 1.Preheating:25~150°C, Time:60~90sec.
- 2.Peak Temp.:255±5°C, Duration:5±0.5sec.
3. Cooling Speed: 2~10°C/sec.

耐焊接热试验条件 / Resistance to Soldering Heat Test Conditions

温度：270±5°C

时间：10±1 sec.

Temp.:270±5°C

Time:10±1 sec

包装规格 / Packaging SPEC.

散件包装 / BULK

Package Type 封装形式	Units 包装数量					Dimension 包装尺寸 (unit: mm ³)		
	Units/Bag 只/袋	Bags/Inner Box 袋/盒	Units/Inner Box 只/盒	Inner Boxes/Outer Box 盒/箱	Units/Outer Box 只/箱	Bag 袋	Inner Box 盒	Outer Box 箱
TO-220/F	200	10	2,000	5	10,000	135×190	237×172×102	560×245×195

套管包装 / TUBE

Package Type 封装形式	Units 包装数量					Dimension 包装尺寸 (unit: mm ³)		
	Units/Tube 只/套管	Tubes/Inner Box 套管/盒	Units/Inner Box 只/盒	Inner Boxes/Outer Box 盒/箱	Units/Outer Box 只/箱	Tube 套管	Inner Box 盒	Outer Box 箱
TO-220/F	50	20	1,000	5	5,000	532×31.4×5.5	555×164×50	575×290×180

使用说明 / Notices

X-ON Electronics

Largest Supplier of Electrical and Electronic Components

Click to view similar products for [MOSFET](#) category:

Click to view products by [Blue Rocket](#) manufacturer:

Other Similar products are found below :

[IRFD120](#) [JANTX2N5237](#) [BUK455-60A/B](#) [MIC4420CM-TR](#) [VN1206L](#) [NDP4060](#) [SI4482DY](#) [IPS70R2K0CEAKMA1](#) [SQD23N06-31L-GE3](#)
[TK16J60W,S1VQ\(O](#) [2SK2614\(TE16L1,Q\)](#) [DMN1017UCP3-7](#) [DMN1053UCP4-7](#) [SQJ469EP-T1-GE3](#) [NTE2384](#) [DMC2700UDMQ-7](#)
[DMN2080UCB4-7](#) [DMN61D9UWQ-13](#) [US6M2GTR](#) [DMN31D5UDJ-7](#) [DMP22D4UFO-7B](#) [DMN1006UCA6-7](#) [DMN16M9UCA6-7](#)
[STF5N65M6](#) [IRF40H233XTMA1](#) [STU5N65M6](#) [DMN6022SSD-13](#) [DMN13M9UCA6-7](#) [DMTH10H4M6SPS-13](#) [DMN2990UFB-7B](#)
[IPB80P04P405ATMA2](#) [2N7002W-G](#) [MCAC30N06Y-TP](#) [MCQ7328-TP](#) [NTMC083NP10M5L](#) [NVMFS2D3P04M8LT1G](#) [BXP7N65D](#)
[BXP4N65F](#) [AOL1454G](#) [WMJ80N60C4](#) [BXP2N20L](#) [BXP2N65D](#) [BXT1150N10J](#) [BXT1700P06M](#) [TSM60NB380CP](#) [ROG](#) [RQ7L055BGTCR](#)
[DMNH15H110SK3-13](#) [SLF10N65ABV2](#) [BSO203SP](#) [BSO211P](#)