

BRCS120P04ZC

Rev.A Jul.-2022

描述 / Descriptions

PDFN5×6 封装 P 沟道场效应管。

P-Channel MOSFET in a PDFN5×6 Plastic Package.

特征 / Features

低电阻可最大地降低导电损耗；低栅极电荷，可实现快速切换；低热阻；无卤产品。

Low $R_{DS(ON)}$ to minimize conductive loss; low Gate Charge for fast switching; Low Thermal resistance; HF Product.

用途 / Applications

笔记本电脑交流输入负载开关，电池保护充电/放电。

Notebook AC-in load switch, Battery Protection Charge/Discharge.

内部等效电路 / Equivalent Circuit

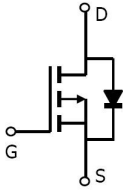

引脚排列 / Pinning

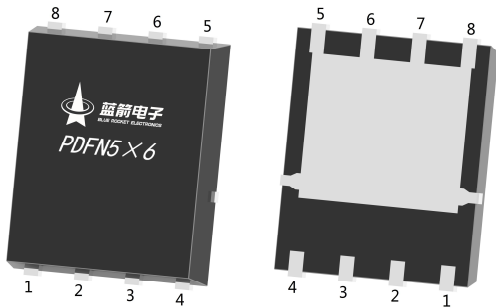

PIN1、2、3: S

PIN4: G

PIN5、6、7、8: D

Pin	极性
1	S
2	S
3	S
4	G
5	D
6	D
7	D
8	D

印章代码 / Marking

见印章说明。

See Marking Instructions.

极限参数 / Absolute Maximum Ratings($T_a=25^{\circ}\text{C}$)

参数 Parameter	符号 Symbol	数值 Rating	单位 Unit
Drain-Source Voltage	V_{DS}	-40	V
Drain Current - Continuous	$I_D(T_c=25^{\circ}\text{C})$	-45	A
Drain Current – Pulsed	I_{DM}	-120	A
Gate-Source Voltage	V_{GS}	± 20	V
Power Dissipation	$P_D(T_c=25^{\circ}\text{C})$	40	W
Single Pulse Avalanche Energy(L=0.5mH)	E_{AS}	317.5	mJ
Avalanche Current(L=0.5mH)	I_{AS}	-31.5	A
Junction and Storage Temperature Range	T_j, T_{stg}	-55 to 150	$^{\circ}\text{C}$
Thermal resistance, junction - ambient	$t \leq 10\text{s}$	$R_{\theta JA}$	$^{\circ}\text{C/W}$
	Steady-State		
Thermal resistance, junction - case	Steady-State	$R_{\theta JC}$	3.1

电性能参数 / Electrical Characteristics($T_a=25^{\circ}\text{C}$)

参数 Parameter	符号 Symbol	测试条件 Test Conditions	最小值 Min	典型值 Typ	最大值 Max	单位 Unit
Drain-Source Breakdown Voltage	BV_{DSS}	$I_D=-250\mu\text{A}$ $V_{GS}=0\text{V}$	-40	-48		V
Zero Gate Voltage Drain Current	I_{DSS}	$V_{DS}=-40\text{V}$ $V_{GS}=0\text{V}$			-1	μA
Gate-Body leakage current	I_{GSS}	$V_{DS}=0\text{V}$, $V_{GS}=\pm 20\text{V}$			± 100	nA
Gate Threshold Voltage	$V_{GS(th)}$	$V_{DS}=V_{GS}$ $I_D=-250\mu\text{A}$	-1	-1.7	-2.5	V
Static Drain-Source On-Resistance	$R_{DS(ON)}$	$V_{GS}=-10\text{V}$, $I_D=-20\text{A}$		11.4	13	m Ω
		$V_{GS}=-4.5\text{V}$, $I_D=-10\text{A}$		15	25	
Diode Forward Voltage	V_{SD}	$I_S=-1\text{A}$, $V_{GS}=0\text{V}$			-1.2	V
Input Capacitance	C_{iss}	$V_{DS}=-25\text{V}$ $V_{GS}=0\text{V}$ $f=1.0\text{MHz}$		4760		pF
Output Capacitance	C_{oss}			2800		
Reverse Transfer Capacitance	C_{rss}			1960		
Gate resistance	R_g	$V_{GS}=0\text{V}$ $V_{DS}=0\text{V}$ $f=1\text{MHz}$		17.5		Ω
Total Gate Charge	$Q_{g(10V)}$	$V_{GS}=-10\text{V}$, $V_{DS}=-20\text{V}$, $I_D=-20\text{A}$		34		nC
Total Gate Charge	$Q_{g(4.5V)}$			17.5		
Gate Source Charge	Q_{gs}			5.8		
Gate Drain Charge	Q_{gd}			9		

电性能参数 / Electrical Characteristics(Ta=25°C)

参数 Parameter	符号 Symbol	测试条件 Test Conditions	最小值 Min	典型值 Typ	最大值 Max	单位 Unit
Turn-On Delay Time	$t_{d(on)}$	$V_{GS}=-10V$ $V_{DS}=-20V$ $R_L=0.75\Omega$ $R_{GEN}=3\Omega$		11		ns
Turn-On Rise Time	t_r			7.8		
Turn-Off Delay Time	$t_{d(off)}$			44		
Turn-Off Fall Time	t_f			18		

电参数曲线图 / Electrical Characteristic Curve

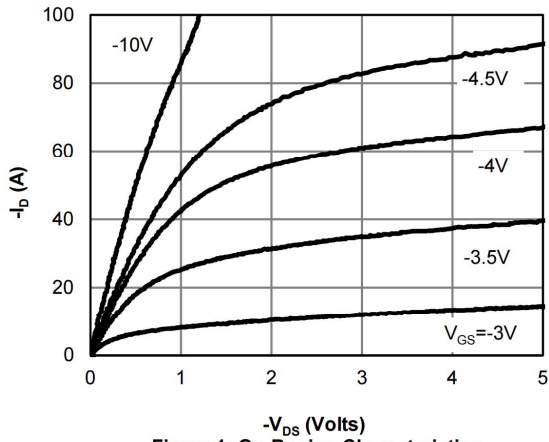

Figure 1: On-Region Characteristics

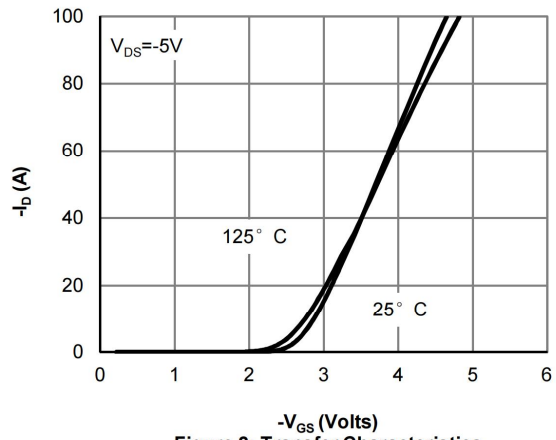

Figure 2: Transfer Characteristics

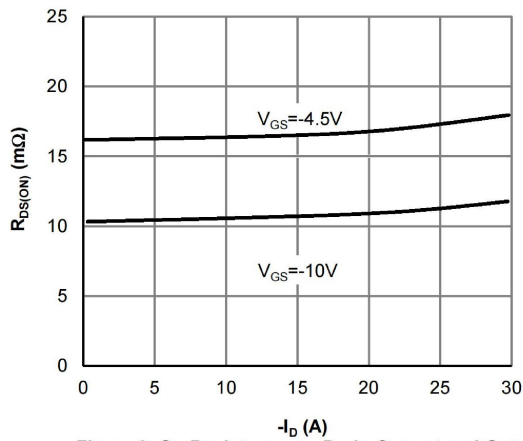

Figure 3: On-Resistance vs. Drain Current and Gate Voltage

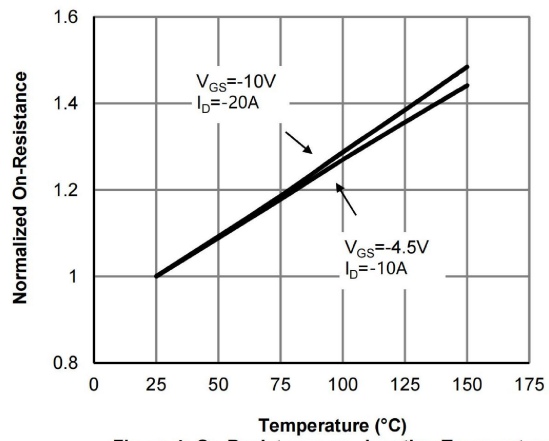

Figure 4: On-Resistance vs. Junction Temperature

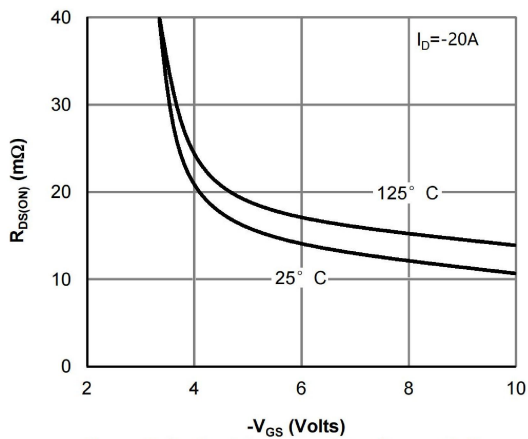

Figure 5: On-Resistance vs. Gate-Source Voltage

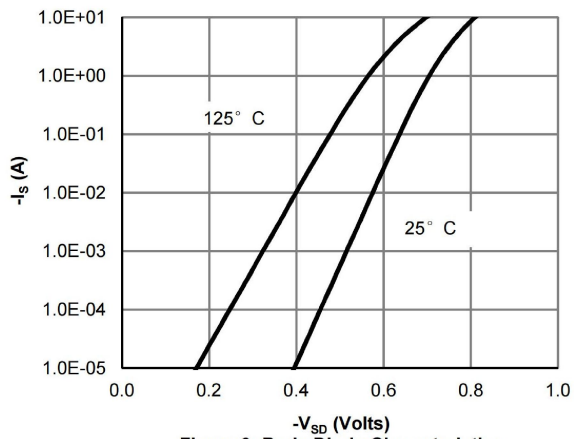

Figure 6: Body-Diode Characteristics

电参数曲线图 / Electrical Characteristic Curve

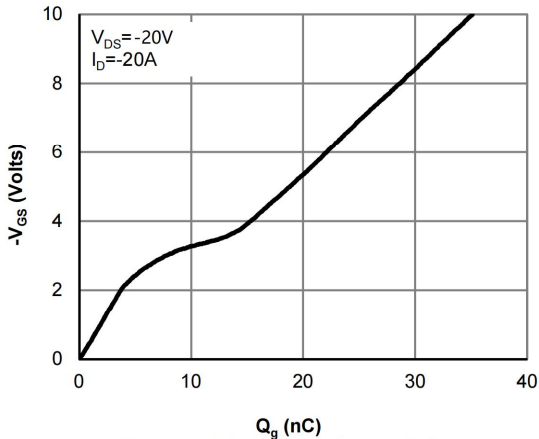

Figure 7: Gate-Charge Characteristics

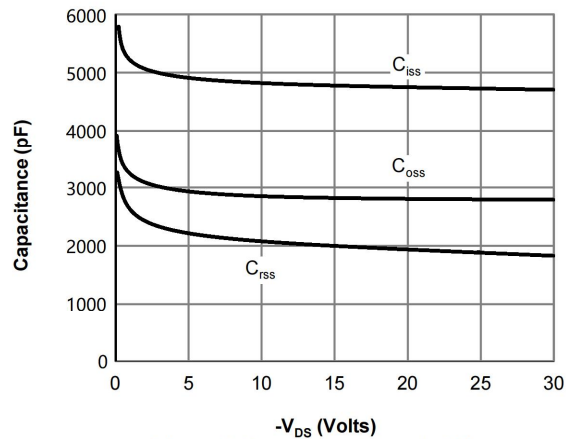

Figure 8: Capacitance Characteristics

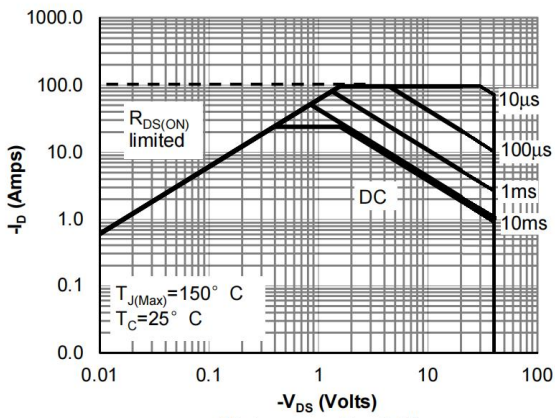

Figure 9: Maximum Forward Biased Safe Operating Area

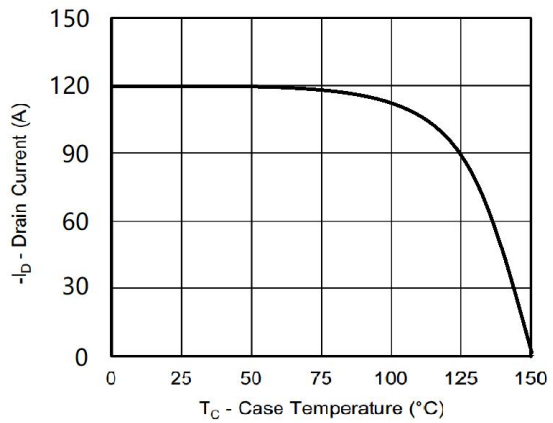

Figure 10: Maximum Continuous Drain Current vs Case Temperature

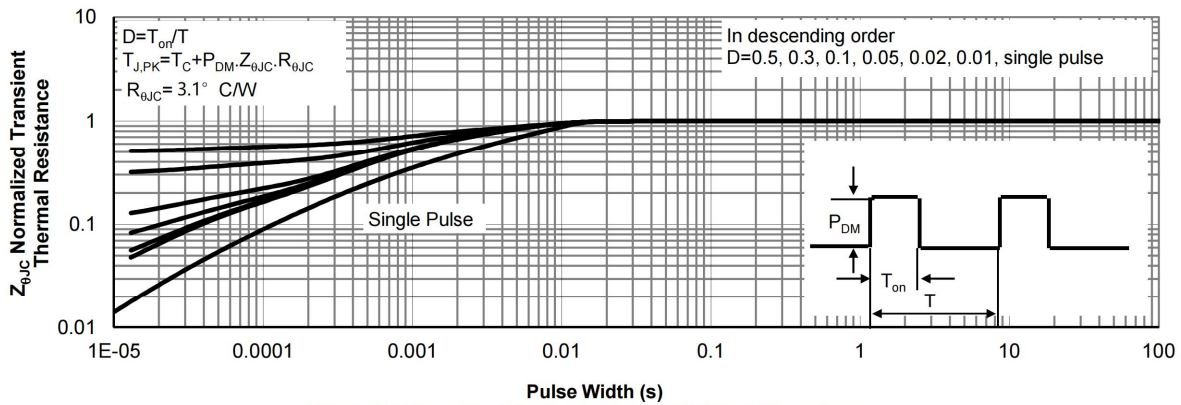
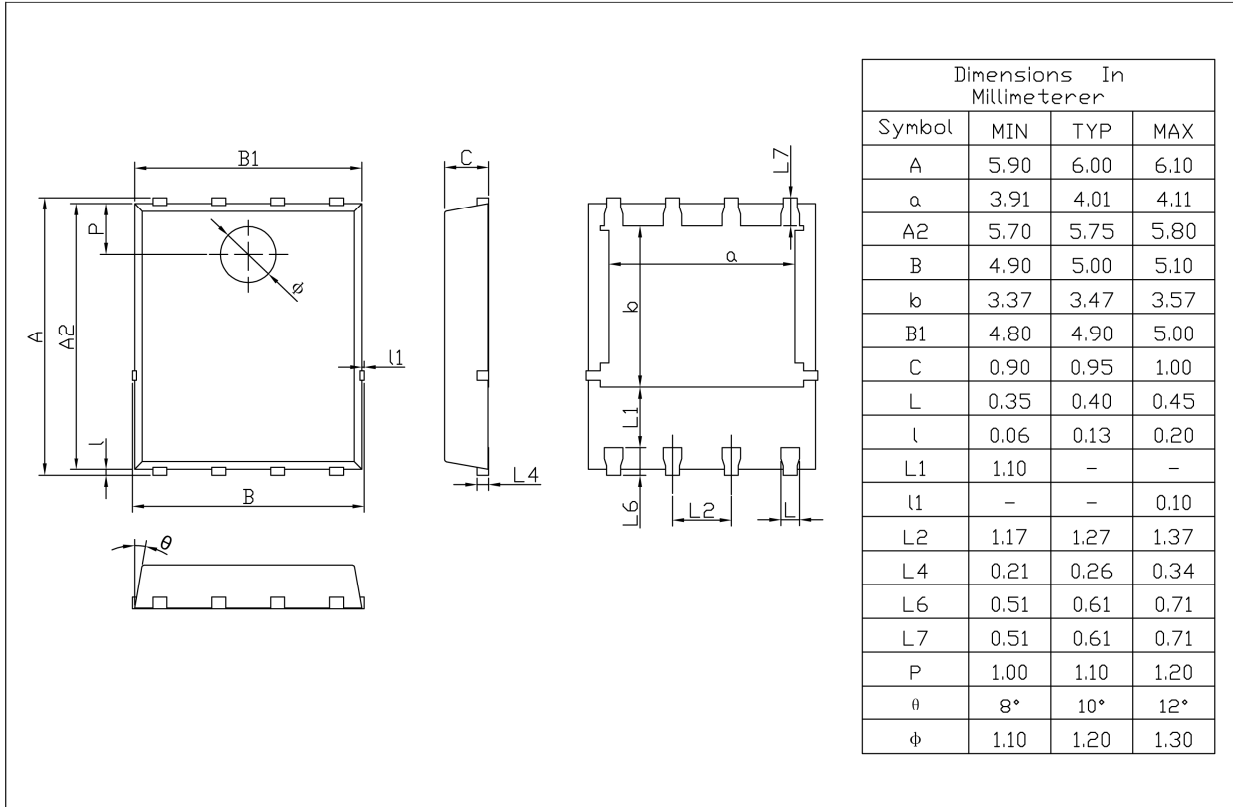

Figure 11: Normalized Maximum Transient Thermal Impedance

外形尺寸图 / Package Dimensions

PDFN5 X6

Unit:mm



Rev.00 201812

印章说明 / Marking Instructions

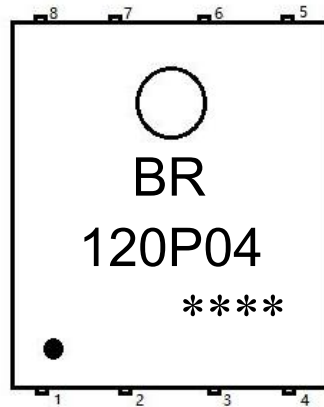

说明：

BR： 为公司代码

120P04： 为产品型号

****： 为生产批号代码，随生产批号变化

Note：

BR： Company Code

120P04： Product Type

****： Lot No. Code, code change with Lot No

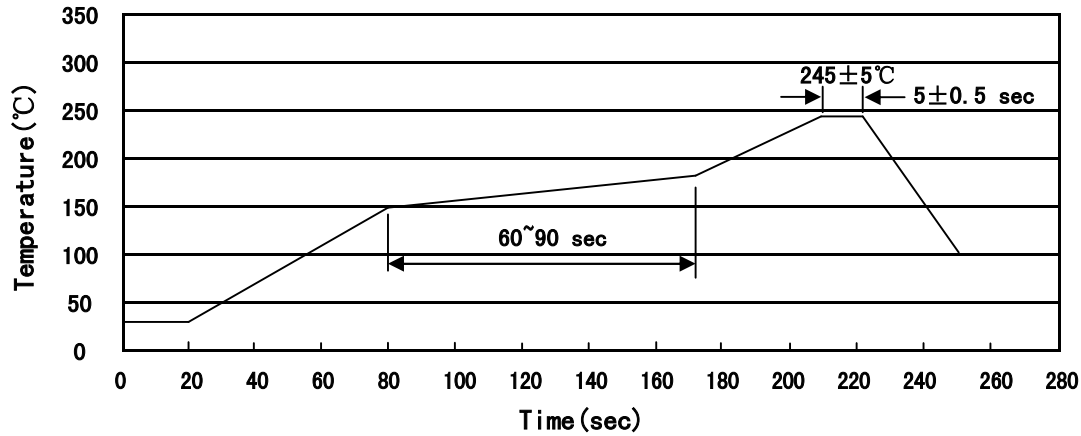
回流焊温度曲线图(无铅) / Temperature Profile for IR Reflow Soldering(Pb-Free)

说明：

- 1、预热温度 150~180°C，时间 60~90sec;
- 2、峰值温度 245±5°C，时间持续为 5±0.5sec;
- 3、焊接制程冷却速度为 2~10°C/sec.

Note:

- 1.Preheating:150~180°C, Time:60~90sec.
- 2.Peak Temp.:245±5°C, Duration:5±0.5sec.
3. Cooling Speed: 2~10°C/sec.

耐焊接热试验条件 / Resistance to Soldering Heat Test Conditions

温度：260±5°C

时间：10±1 sec.

Temp.:260±5°C

Time:10±1 sec

包装规格 / Packaging SPEC.

卷盘包装 / REEL

Package Type 封装形式	Units 包装数量					Dimension 包装尺寸 (unit: mm ³)		
	Units/Reel 只/卷盘	Reels/Inner Box 卷盘/盒	Units/Inner Box 只/盒	Inner Boxes/Outer Box 盒/箱	Units/Outer Box 只/箱	Reel	Inner Box 盒	Outer Box 箱
PDFN5×6	5000	2	10000	6	60000	13"×12	360×360×50	380×335×366

使用说明 / Notices

X-ON Electronics

Largest Supplier of Electrical and Electronic Components

Click to view similar products for [MOSFET](#) category:

Click to view products by [Blue Rocket](#) manufacturer:

Other Similar products are found below :

[IRFD120](#) [JANTX2N5237](#) [BUK455-60A/B](#) [MIC4420CM-TR](#) [VN1206L](#) [NDP4060](#) [SI4482DY](#) [IPS70R2K0CEAKMA1](#) [SQD23N06-31L-GE3](#)
[TK16J60W,S1VQ\(O](#) [2SK2614\(TE16L1,Q\)](#) [DMN1017UCP3-7](#) [DMN1053UCP4-7](#) [SQJ469EP-T1-GE3](#) [NTE2384](#) [DMC2700UDMQ-7](#)
[DMN2080UCB4-7](#) [DMN61D9UWQ-13](#) [US6M2GTR](#) [DMN31D5UDJ-7](#) [DMP22D4UFO-7B](#) [DMN1006UCA6-7](#) [DMN16M9UCA6-7](#)
[STF5N65M6](#) [IRF40H233XTMA1](#) [STU5N65M6](#) [DMN6022SSD-13](#) [DMN13M9UCA6-7](#) [DMTH10H4M6SPS-13](#) [DMN2990UFB-7B](#)
[IPB80P04P405ATMA2](#) [2N7002W-G](#) [MCAC30N06Y-TP](#) [MCQ7328-TP](#) [NTMC083NP10M5L](#) [NVMFS2D3P04M8LT1G](#) [BXP7N65D](#)
[BXP4N65F](#) [AOL1454G](#) [WMJ80N60C4](#) [BXP2N20L](#) [BXP2N65D](#) [BXT1150N10J](#) [BXT1700P06M](#) [TSM60NB380CP](#) [ROG](#) [RQ7L055BGTCR](#)
[DMNH15H110SK3-13](#) [SLF10N65ABV2](#) [BSO203SP](#) [BSO211P](#)