

描述 / Descriptions

SOT23-3 塑封封装 P 道 MOS 场效应管。

P- CHANNEL MOSFET in a SOT23-3 Plastic Package.

特征 / Features

沟道技术，功率场效应晶体管。

Trench FET@ Power MOSFET 。

无卤产品。HF Product.

用途 / Applications

主要用于显示屏驱动。

Primarily the display screen drive applications.

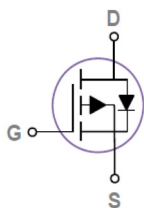
内部等效电路 / Equivalent Circuit**引脚排列 / Pinning**

PIN 1 : G

PIN 2 : S

PIN 3 : D

印章代码 / Marking

Marking	H305
---------	------

极限参数 / Absolute Maximum Ratings(Ta=25°C)

参数 Parameter	符号 Symbol	数值 Rating	单位 Unit
Drain-Source Voltage	V_{DSS}	-20	V
Gate-Source Voltage	V_{GSS}	± 12	V
Drain Current – Continuous	I_D	-3.5	A
Drain Current – Continuous	$I_D(T_A=70^\circ\text{C})$	-2.8	A
Pulsed Drain Current	I_{DM}	-16	A
Continuous Source Current	I_S	1.25	A
Power Dissipation	P_D	1.25	W
Power Dissipation	$P_D(T_A=70^\circ\text{C})$	0.80	W
Storage Temperature Range	T_{stg}	-55 ~ 150	°C

电性能参数 / Electrical Characteristics(Ta=25°C)

参数 Parameter	符号 Symbol	测试条件 Test Conditions	最小值 Min	典型值 Typ	最大值 Max	单位 Unit
Drain–Source Breakdown Voltage	$V_{(BR)DSS}$	$V_{GS}=0V$ $I_D=250\mu A$	-20			V
Gate Threshold Voltage	$V_{GS(th)}$	$V_{DS}=V_{GS}$ $I_D=250\mu A$	-0.4		-1.0	V
Static Drain–Source On–Resistance	$R_{DS(on)1}$	$V_{GS}=10V$ $I_D=3.5A$			30	mΩ
	$R_{DS(on)2}$	$V_{GS}=4.5V$ $I_D=2.8A$			40	mΩ
Zero Gate Voltage Drain Current	$I_{DSS(1)}$	$V_{DS}=20V$ $V_{GS}=0V$			1	μA
	$I_{DSS(2)}$	$V_{DS}=30V$ $V_{GS}=0V$ $T_j=55^\circ\text{C}$			30	μA
Gate–Body Leakage.	I_{GSS}	$V_{GS}=\pm 12V$ $V_{DS}=0V$			± 0.1	μA
State Drain Current	$I_{D(1)}$	$V_{DS}\geq 4.5V$ $V_{GS}=10V$	-6			A
	$I_{D(2)}$	$V_{DS}\geq 4.5V$ $V_{GS}=4.5V$	-3			A
Drain–Source Diode Forward Voltage	V_{SD}	$I_S=1.25A$ $V_{GS}=0V$		-0.8	-1.2	V
Forward Transconductance	g_{FS}	$V_{DS}=4.5V$ $I_D=3.5A$		6.5		S
Gate Resistance	R_g		0.5		2.4	Ω
Input Capacitance	C_{iss}	$V_{DS}=15V$ $V_{GS}=0V$ $f=1.0\text{MHz}$		415		pF
Output Capacitance	C_{oss}			223		
Reverse Transfer Capacitance	C_{rss}			84		
Turn–On Delay Time	$t_{d(on)}$	$V_{DD}=15V$ $R_L=15\Omega$ $I_D\approx 1.0A$ $V_{GEN}=10V$ $R_G=6.0\Omega$		13	25	ns
Turn–On Rise Time	t_r			36	60	
Turn–Off Delay Time	$t_{d(off)}$			42	70	
Turn–Off Fall Time	t_f			34	60	

电参数曲线图 / Electrical Characteristic Curve

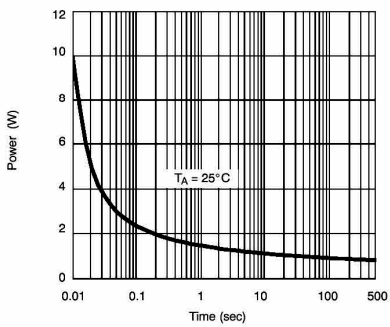
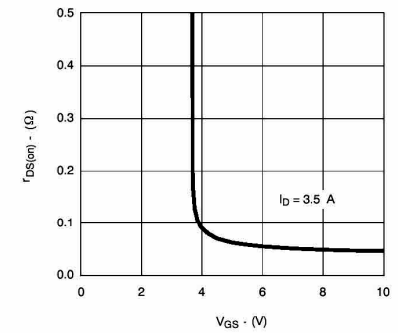
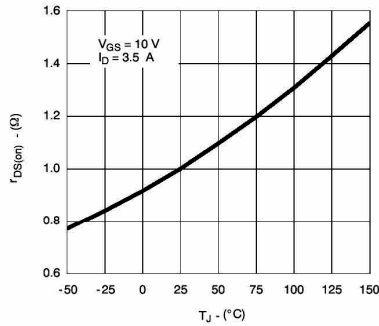
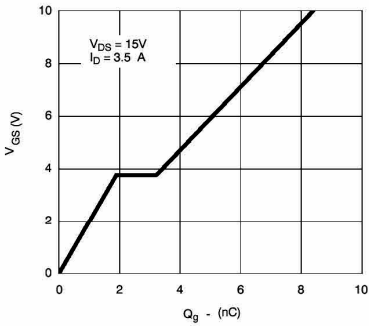
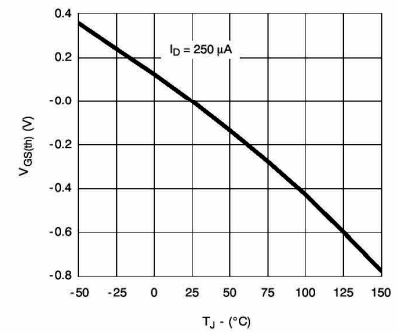
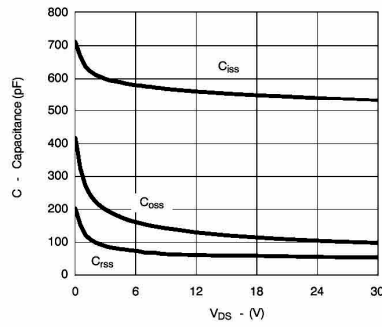
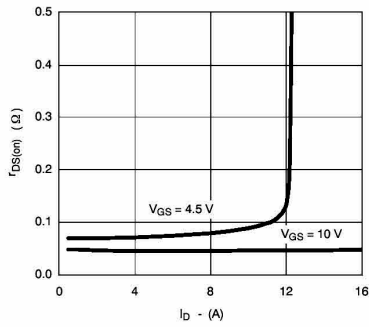
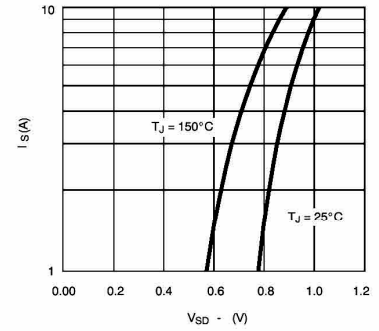
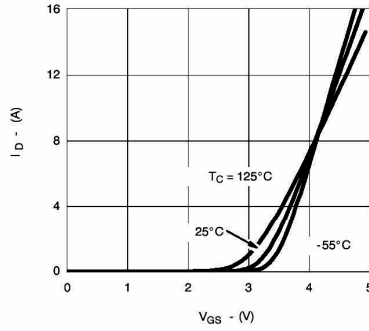
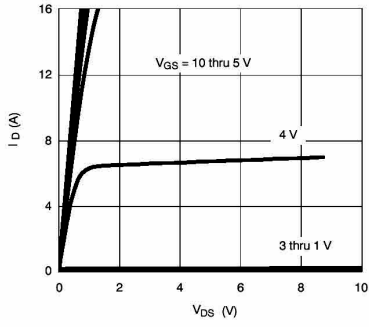

外形尺寸图 / Package Dimensions

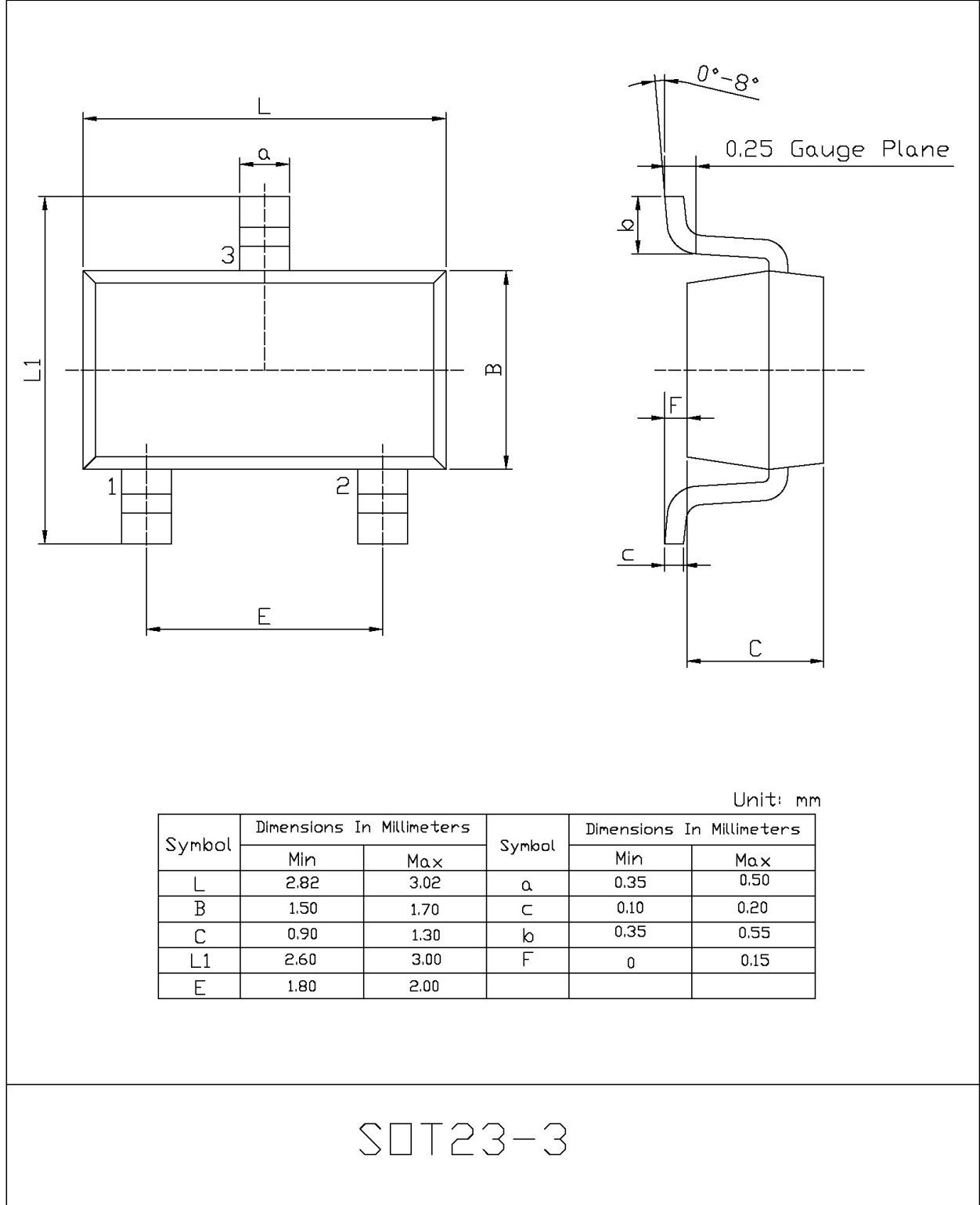

印章说明 / Marking Instructions

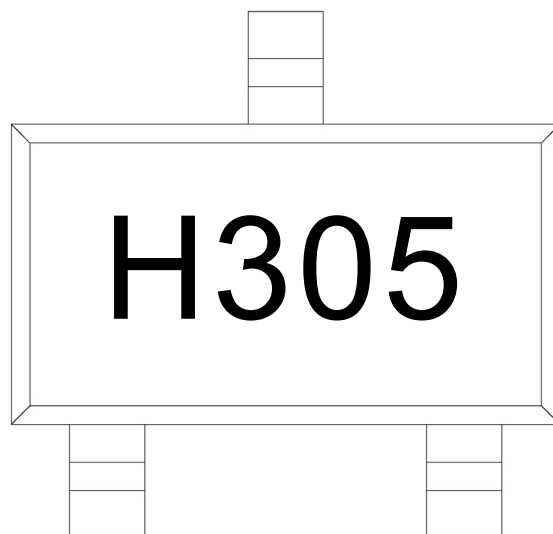

说明：

H: 为公司代码

305: 为型号代码

Note:

H: Company Code.

305 : Product Type

回流焊温度曲线图(无铅) / Temperature Profile for IR Reflow Soldering(Pb-Free)

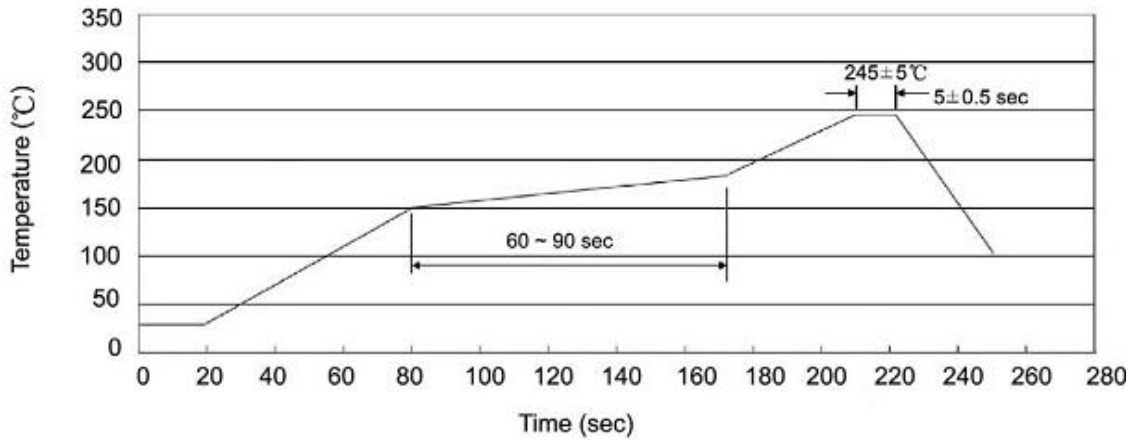

说明：

- 1、预热温度 150 ~ 180°C，时间 60 ~ 90sec;
- 2、峰值温度 245±5°C，时间持续为 5±0.5sec;
- 3、焊接制程冷却速度为 2 ~ 10°C/sec.

Note:

- 1.Preheating:150~180°C, Time:60~90sec.
- 2.Peak Temp.:245±5°C, Duration:5±0.5sec.
3. Cooling Speed: 2~10°C/sec.

耐焊接热试验条件 / Resistance to Soldering Heat Test Conditions

温度：260±5°C

时间：10±1 sec.

Temp.:260±5°C

Time:10±1 sec

包装规格 / Packaging SPEC.

卷盘包装 / REEL

Package Type 封装形式	Units 包装数量					Dimension 包装尺寸 (unit: mm ³)		
	Units/Reel 只/卷盘	Reels/Inner Box 卷盘/盒	Units/Inner Box 只/盒	Inner Boxes/Outer Box 盒/箱	Units/Outer Box 只/箱	Reel	Inner Box 盒	Outer Box 箱
SOT23-3	3,000	10	30,000	4	120,000	7" ×8	210×205×205	445×230×435

使用说明 / Notices

X-ON Electronics

Largest Supplier of Electrical and Electronic Components

Click to view similar products for [MOSFET](#) category:

Click to view products by [Blue Rocket](#) manufacturer:

Other Similar products are found below :

[614233C](#) [648584F](#) [MCH3443-TL-E](#) [MCH6422-TL-E](#) [FDPF9N50NZ](#) [NTNS3A92PZT5G](#) [IRFD120](#) [IRFF430](#) [JANTX2N5237](#) [2N7000](#)
[AOD464](#) [2SK2267\(Q\)](#) [2SK2545\(Q,T\)](#) [405094E](#) [423220D](#) [MIC4420CM-TR](#) [VN1206L](#) [614234A](#) [715780A](#) [751625C](#)
[IPS70R2K0CEAKMA1](#) [BSF024N03LT3 G](#) [PSMN4R2-30MLD](#) [TK31J60W5,S1VQ\(O](#) [2SK2614\(TE16L1,Q\)](#) [DMN1017UCP3-7](#)
[EFC2J004NUZTDG](#) [FCAB21350L1](#) [P85W28HP2F-7071](#) [DMN1053UCP4-7](#) [NTE2384](#) [NTE2969](#) [NTE6400A](#) [DMC2700UDMQ-7](#)
[DMN2080UCB4-7](#) [DMN61D9UWQ-13](#) [US6M2GTR](#) [DMN31D5UDJ-7](#) [SSM6P54TU,LF](#) [DMP22D4UFO-7B](#) [IPS60R3K4CEAKMA1](#)
[DMN1006UCA6-7](#) [DMN16M9UCA6-7](#) [STF5N65M6](#) [IRF40H233XTMA1](#) [IPSA70R950CEAKMA1](#) [IPSA70R2K0CEAKMA1](#) [STU5N65M6](#)
[C3M0021120D](#) [DMN6022SSD-13](#)