

BRC5700P10DP

Rev.B Nov.-2022

描述 / Descriptions

TO-252 塑封封装 P 沟道 MOS 场效应管。
P-CHANNEL MOSFET in a TO-252 Plastic Package.

特征 / Features

阻抗低，开关速度快，无卤产品。
Low On-Resistance, fast switching, HF Product.

用途 / Applications

工业级DC/DC转换器的电源管理
Power Management of Industrial DC/DC Converter.

内部等效电路 / Equivalent Circuit

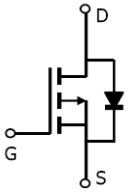

引脚排列 / Pinning

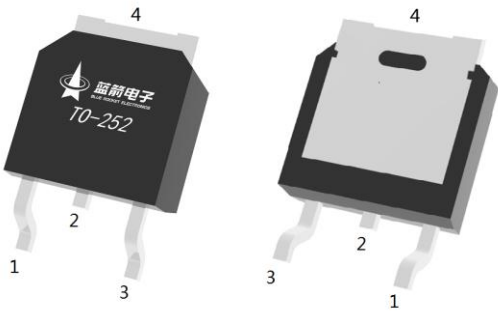

PIN 1 : G PIN 2 : D PIN 3 : S PIN 4 : D

印章代码 / Marking

见印章说明。
See Marking Instructions.

极限参数 / Absolute Maximum Ratings(T_a=25°C)

| 参数 Parameter | 符号 Symbol | 数值 Rating | 单位 Unit |
|--|---------------------------------------|--------------|------------|
| Drain-Source Voltage | V _{DS} | -100 | V |
| Drain Current - Continuous | I _D (T _c =25°C) | -14 | A |
| Drain Current – Pulsed | I _{DM} | -30 | A |
| Gate-Source Voltage | V _{GS} | ±20 | V |
| Power Dissipation | P _D (T _c =25°C) | 30 | W |
| Single Pulse Avalanche Energy(L=0.5mH) | E _{AS} | 176.4 | mJ |
| Avalanche Current(L=0.5mH) | I _{AS} | -21 | A |
| Junction and Storage Temperature Range | T _j , T _{stg} | -55 to 150 | °C |
| Thermal resistance, junction - ambient | t ≤ 10s | 16.7 | °C/W |
| | Steady-State | 41.7 | |
| Thermal resistance, junction - case | Steady-State | 4.2 | |

电性能参数 / Electrical Characteristics(T_a=25°C)

| 参数 Parameter | 符号 Symbol | 测试条件 Test Conditions | 最小值 Min | 典型值 Typ | 最大值 Max | 单位 Unit |
|-----------------------------------|----------------------|--|------------|------------|------------|------------|
| Drain-Source Breakdown Voltage | BV _{DSS} | I _D =-250μA V _{GS} =0V | -100 | -113 | | V |
| Zero Gate Voltage Drain Current | I _{DSS} | V _{DS} =-100V V _{GS} =0V | | | -1 | μA |
| Gate-Body leakage current | I _{GSS} | V _{DS} =0V, V _{GS} = ±20V | | | ±100 | nA |
| Gate Threshold Voltage | V _{GS(th)} | V _{DS} =V _{GS} I _D =-250μA | -1 | -2.0 | -2.5 | V |
| Static Drain-Source On-Resistance | R _{DS(ON)} | V _{GS} =-10V, I _D =-10A | | 67 | 70 | mΩ |
| | | V _{GS} =-4.5V, I _D =-6A | | 70 | 85 | |
| Diode Forward Voltage | V _{SD} | I _S =-1A, V _{GS} =0V | | | -1.2 | V |
| Input Capacitance | C _{iss} | V _{DS} =-15V V _{GS} =0V f=1.0MHz | | 2820 | | pF |
| Output Capacitance | C _{oss} | | | 840 | | |
| Reverse Transfer Capacitance | C _{rss} | | | 670 | | |
| Gate resistance | R _g | V _{GS} =0V V _{DS} =0V f=1MHz | | 2.7 | | Ω |
| Total Gate Charge | Q _{g(10V)} | V _{GS} =-10V, V _{DS} =-50V, I _D =-5A | | 5.9 | | nC |
| Total Gate Charge | Q _{g(4.5V)} | | | 2.7 | | |
| Gate Source Charge | Q _{gs} | | | 1.2 | | |
| Gate Drain Charge | Q _{gd} | | | 1.2 | | |

电性能参数 / Electrical Characteristics(Ta=25°C)

| 参数 Parameter | 符号 Symbol | 测试条件 Test Conditions | 最小值 Min | 典型值 Typ | 最大值 Max | 单位 Unit |
|---------------------|--------------|---|------------|------------|------------|------------|
| Turn-On Delay Time | $t_{d(on)}$ | $V_{GS}=-10V$ $V_{DS}=-50V$ $R_L=10\ \Omega$ $R_{GEN}=3\ \Omega$ | | 6 | | ns |
| Turn-On Rise Time | t_r | | | 2.4 | | |
| Turn-Off Delay Time | $t_{d(off)}$ | | | 19 | | |
| Turn-Off Fall Time | t_f | | | 2.6 | | |

电参数曲线图 / Electrical Characteristic Curve

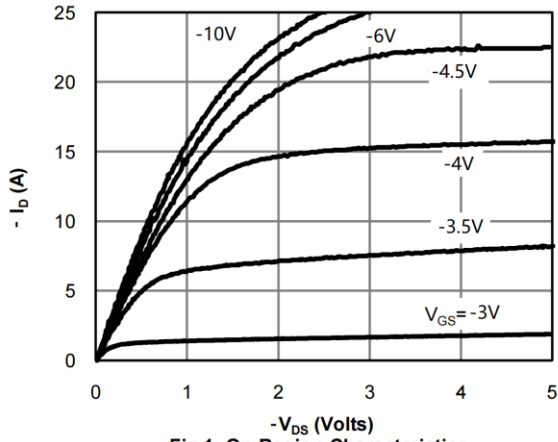

Fig 1: On-Region Characteristics

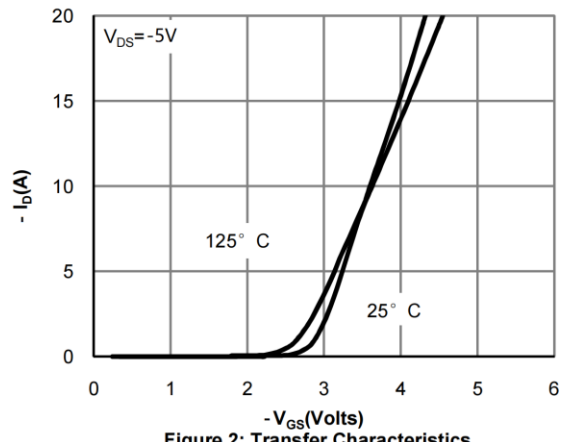

Figure 2: Transfer Characteristics

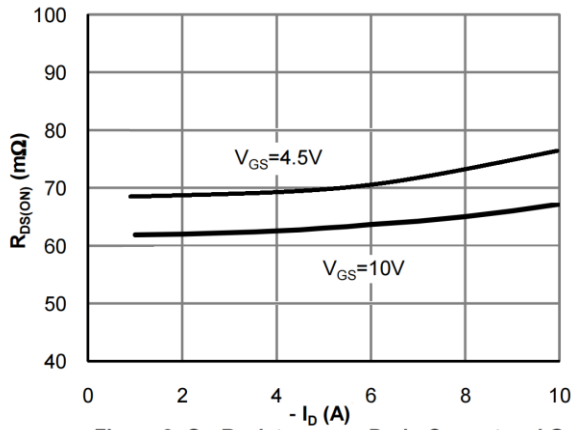

Figure 3: On-Resistance vs. Drain Current and Gate Voltage

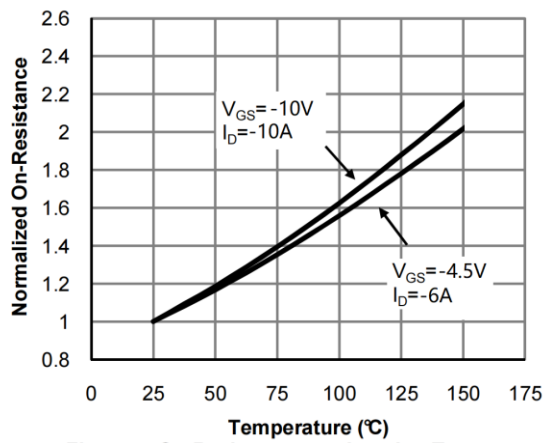

Figure 4: On-Resistance vs. Junction Temperature

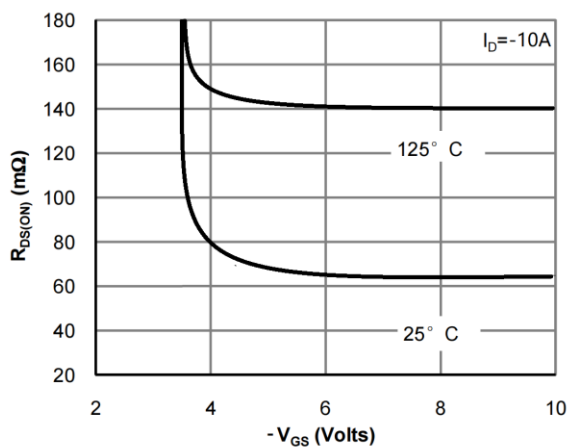

Figure 5: On-Resistance vs. Gate-Source Voltage

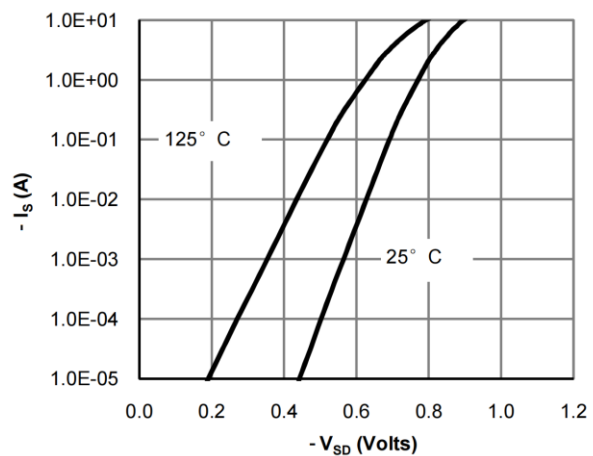

Figure 6: Body-Diode Characteristics

电参数曲线图 / Electrical Characteristic Curve

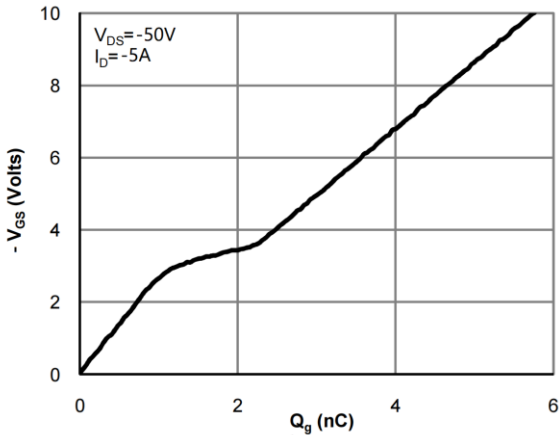

Figure 7: Gate-Charge Characteristics

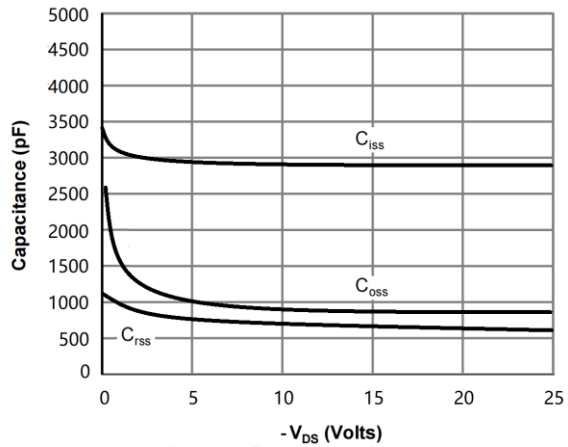

Figure 8: Capacitance Characteristics

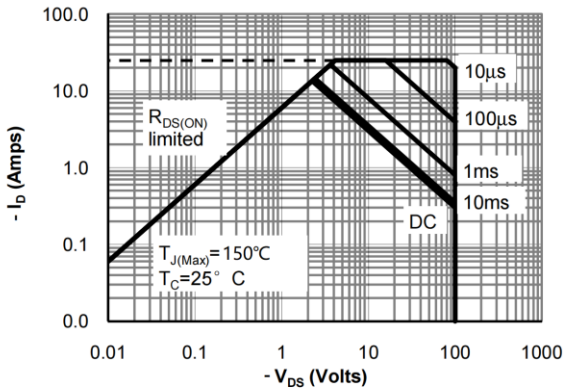

Figure 9: Maximum Forward Biased Safe Operating Area

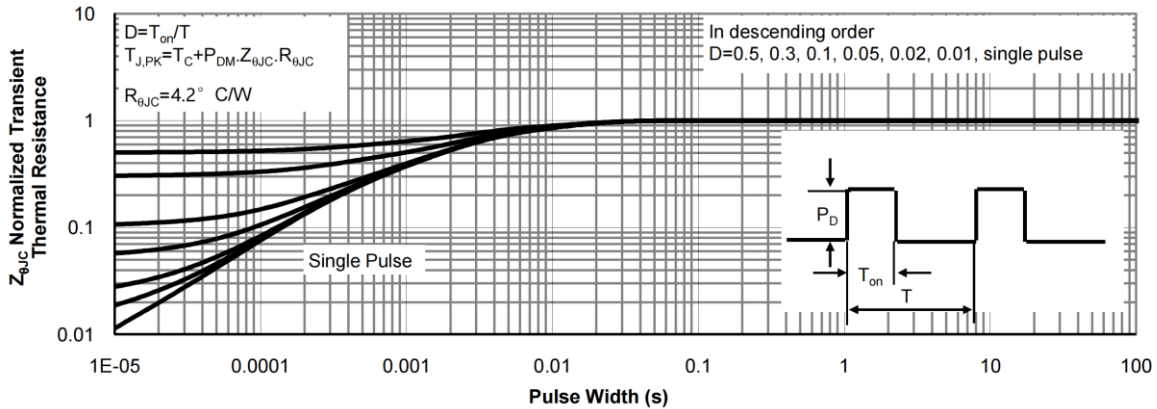
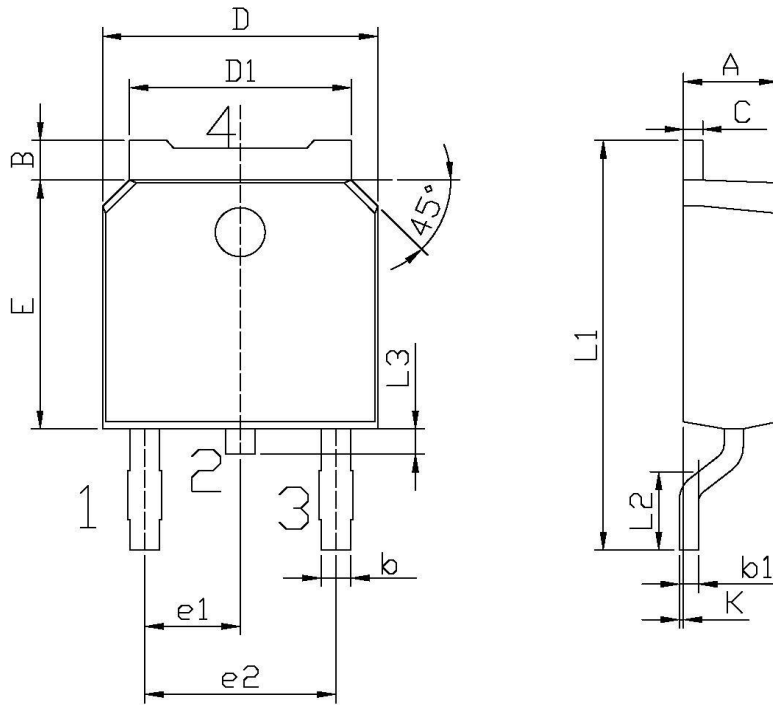

Figure 10: Normalized Maximum Transient Thermal Impedance

外形尺寸图 / Package Dimensions



单位: mm

| Symbol | Dimensions In Millimeters | | Symbol | Dimensions In Millimeters | |
|--------|---------------------------|------|--------|---------------------------|-------|
| | Min | Max | | Min | Max |
| A | 2.20 | 2.40 | E | 5.95 | 6.25 |
| B | 0.95 | 1.25 | e1 | 2.24 | 2.34 |
| b | 0.70 | 0.90 | e2 | 4.43 | 4.73 |
| b1 | 0.45 | 0.55 | L1 | 9.85 | 10.35 |
| C | 0.45 | 0.55 | L2 | 1.70 | 2.00 |
| D | 6.45 | 6.75 | L3 | 0.60 | 0.90 |
| D1 | 5.10 | 5.50 | K | 0.00 | 0.10 |

TO-252

印章说明 / Marking Instructions

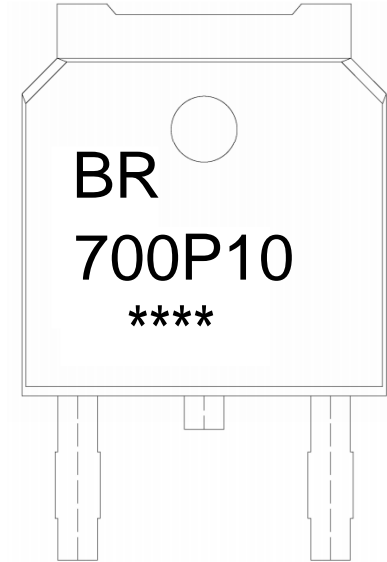

说明：

BR： 为公司代码

700P10： 为产品型号

****： 为生产批号代码，随生产批号变化

Note:

BR: Company Code

700P10: Product Type

****: Lot No. Code, code change with Lot No

回流焊温度曲线图(无铅) / Temperature Profile for IR Reflow Soldering(Pb-Free)

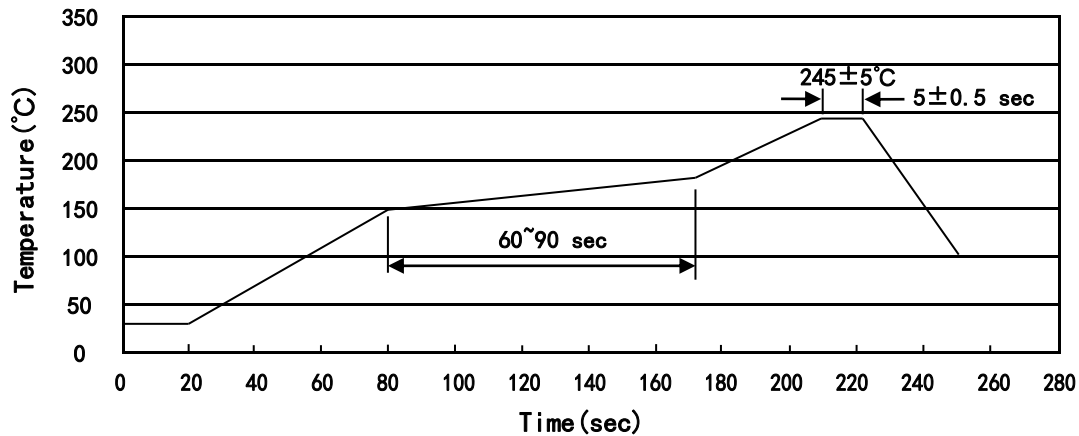

说明：

- 1、预热温度 150~180°C，时间 60~90sec;
- 2、峰值温度 245±5°C，时间持续为 5±0.5sec;
- 3、焊接制程冷却速度为 2~10°C/sec.

Note:

- 1.Preheating:150~180°C, Time:60~90sec.
- 2.Peak Temp.:245±5°C, Duration:5±0.5sec.
3. Cooling Speed: 2~10°C/sec.

耐焊接热试验条件 / Resistance to Soldering Heat Test Conditions

温度：260±5°C

时间：10±1 sec.

Temp.:260±5°C

Time:10±1 sec

包装规格 / Packaging SPEC.

卷盘包装 / REEL

| Package Type 封装形式 | Units 包装数量 | | | | | Dimension 包装尺寸 (unit: mm ³) | | |
|----------------------|--------------------|-------------------------|------------------------|------------------------------|------------------------|---|-------------|-------------|
| | Units/Reel 只/卷盘 | Reels/Inner Box 卷盘/盒 | Units/Inner Box 只/盒 | Inner Boxes/Outer Box 盒/箱 | Units/Outer Box 只/箱 | Reel | Inner Box 盒 | Outer Box 箱 |
| TO-252 | 2,500 | 2 | 5,000 | 6 | 30,000 | 13" ×16 | 360×360×50 | 380×335×366 |

套管包装 / TUBE

| Package Type 封装形式 | Units 包装数量 | | | | | Dimension 包装尺寸 (unit: mm ³) | | |
|----------------------|--------------------|-------------------------|------------------------|------------------------------|------------------------|---|-------------|-------------|
| | Units/Tube 只/套管 | Tubes/Inner Box 套管/盒 | Units/Inner Box 只/盒 | Inner Boxes/Outer Box 盒/箱 | Units/Outer Box 只/箱 | Tube 套管 | Inner Box 盒 | Outer Box 箱 |
| TO-251/252 | 75 | 48 | 3,600 | 5 | 18,000 | 526×20.5×5.25 | 555×164×50 | 575×290×180 |

使用说明 / Notices

X-ON Electronics

Largest Supplier of Electrical and Electronic Components

Click to view similar products for [MOSFET](#) category:

Click to view products by [Blue Rocket](#) manufacturer:

Other Similar products are found below :

[IRFD120](#) [JANTX2N5237](#) [BUK455-60A/B](#) [MIC4420CM-TR](#) [VN1206L](#) [NDP4060](#) [SI4482DY](#) [IPS70R2K0CEAKMA1](#) [SQD23N06-31L-GE3](#)
[TK16J60W,S1VQ\(O](#) [2SK2614\(TE16L1,Q\)](#) [DMN1017UCP3-7](#) [DMN1053UCP4-7](#) [SQJ469EP-T1-GE3](#) [NTE2384](#) [DMC2700UDMQ-7](#)
[DMN2080UCB4-7](#) [DMN61D9UWQ-13](#) [US6M2GTR](#) [DMN31D5UDJ-7](#) [DMP22D4UFO-7B](#) [DMN1006UCA6-7](#) [DMN16M9UCA6-7](#)
[STF5N65M6](#) [IRF40H233XTMA1](#) [STU5N65M6](#) [DMN6022SSD-13](#) [DMN13M9UCA6-7](#) [DMTH10H4M6SPS-13](#) [DMN2990UFB-7B](#)
[IPB80P04P405ATMA2](#) [2N7002W-G](#) [MCAC30N06Y-TP](#) [MCQ7328-TP](#) [NTMC083NP10M5L](#) [NVMFS2D3P04M8LT1G](#) [BXP7N65D](#)
[BXP4N65F](#) [AOL1454G](#) [WMJ80N60C4](#) [BXP2N20L](#) [BXP2N65D](#) [BXT1150N10J](#) [BXT1700P06M](#) [TSM60NB380CP](#) [ROG](#) [RQ7L055BGTCR](#)
[DMNH15H110SK3-13](#) [SLF10N65ABV2](#) [BSO203SP](#) [BSO211P](#)