

描述 / Descriptions

SOD-323 塑封封装 稳压二极管。
Zener Diode in a SOD-323 Plastic Package.

特征 / Features

200mW 功耗, 中等电流, 自动贴片组装。
200mW Power dissipation, medium current, automated assembly processes.

用途 / Applications

适用于 2.4V-39V 的宽范围稳压电路。
2.4V to 39V wide zener voltage range applications.

内部等效电路 / Equivalent Circuit

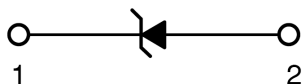

引脚排列 / Pinning



PIN1:Cathode PIN2:Anode

放大及印章代码 / h_{FE} Classifications & Marking

见电性能参数。 See Electrical Characteristics.

极限参数 / Absolute Maximum Ratings(Ta=25°C)

参数 Parameter	符号 Symbol	数值 Rating	单位 Unit
Forward Voltage (Note 2) (I _F =10mA)	V _F	0.9	V
Power Dissipation(Note 1)	P _D	200	mW
Typical Thermal Resistance Junction to Ambient(Note 1)	R _{θJA}	625	°C/W
Junction and Storage Temperature Range	T _j ,T _{stg}	-65~150	°C

电性能参数 / Electrical Characteristics(Ta=25°C)

Type Number	Mark- ing Code	Zener Voltage Range (Note 2)				Maximum Zener mpedance (Note 3)			Maximum Reverse Current (Note 2)		Typical Temperature Coefficient @I _{ZTC} mV/°C		Test Curre nt I _{ZTC}
		V _z @I _{ZT}			I _{ZT}	Z _{ZT} @I _{ZT}	Z _{ZK} @I _{ZK}	I _{ZK}	I _R	@V _R	Min	Max	
		Nom (V)	Min (V)	Max (V)	mA	Ω		mA	uA	V			
BZT52C2V4S	HWX	2.4	2.2	2.6	5	100	600	1	50	1	-3.5	0	5
BZT52C2V7S	HW1	2.7	2.5	2.9	5	100	600	1	20	1	-3.5	0	5
BZT52C3V0S	HW2	3.0	2.8	3.2	5	95	600	1	10	1	-3.5	0	5
BZT52C3V3S	HW3	3.3	3.1	3.5	5	95	600	1	5	1	-3.5	0	5
BZT52C3V6S	HW4	3.6	3.4	3.8	5	90	600	1	5	1	-3.5	0	5
BZT52C3V9S	HW5	3.9	3.7	4.1	5	90	600	1	3	1	-3.5	0	5
BZT52C4V3S	HW6	4.3	4	4.6	5	90	600	1	3	1	-3.5	0	5
BZT52C4V7S	HW7	4.7	4.4	5	5	80	500	1	3	2	-3.5	0.2	5
BZT52C5V1S	HW8	5.1	4.8	5.4	5	60	480	1	2	2	-2.7	1.2	5
BZT52C5V6S	HW9	5.6	5.2	6	5	40	400	1	1	2	-2	2.5	5
BZT52C6V2S	HWA	6.2	5.8	6.6	5	10	150	1	3	4	0.4	3.7	5
BZT52C6V8S	HWB	6.8	6.4	7.2	5	15	80	1	2	4	1.2	4.5	5
BZT52C7V5S	HWC	7.5	7	7.9	5	15	80	1	1	5	2.5	5.3	5
BZT52C8V2S	HWD	8.2	7.7	8.7	5	15	80	1	0.7	5	3.2	6.2	5
BZT52C9V1S	HWE	9.1	8.5	9.6	5	15	100	1	0.5	6	3.8	7	5
BZT52C10S	HWF	10	9.4	10.6	5	20	150	1	0.2	7	4.5	8	5

电性能参数 / Electrical Characteristics(Ta=25°C)

Type Number	Marking Code	Zener Voltage Range (Note 2)				Maximum Zener Impedance (Note 3)			Maximum Reverse Current (Note 2)		Typical Temperature Coefficient @I _{ZTC} mV/°C		Test Current I _{ZTC} mA
		V _Z @I _{ZT}			I _{ZT}	Z _{ZT} @I _{ZT}	Z _{ZK} @I _{ZK}	I _{ZK}	I _R	@V _R	Min	Max	
		Nom (V)	Min (V)	Max (V)	mA	Ω		mA	uA	V			
BZT52C11S	HWG	11	10.4	11.6	5	20	150	1	0.1	8	5.4	9	5
BZT52C12S	HWH	12	11.4	12.7	5	25	150	1	0.1	8	6	10	5
BZT52C13S	HWI	13	12.4	14.1	5	30	170	1	0.1	8	7	11	5
BZT52C15S	HWJ	15	13.8	15.6	5	30	200	1	0.1	10.5	9.2	13	5
BZT52C16S	HWK	16	15.3	17.1	5	40	200	1	0.1	11.2	10.4	14	5
BZT52C18S	HWL	18	16.8	19.1	5	45	225	1	0.1	12.6	12.4	16	5
BZT52C20S	HWM	20	18.8	21.2	5	55	225	1	0.1	14	14.4	18	5
BZT52C22S	HWN	22	20.8	23.3	5	55	250	1	0.1	15.4	16.4	20	5
BZT52C24S	HWO	24	22.8	25.6	5	70	250	1	0.1	16.8	18.4	22	5
BZT52C27S	HWP	27	25.1	28.9	2	80	300	0.5	0.1	18.9	21.4	25.3	2
BZT52C30S	HWQ	30	28	32	2	80	300	0.5	0.1	21	24.4	29.4	2
BZT52C33S	HWR	33	31	35	2	80	325	0.5	0.1	23.1	27.4	33.4	2
BZT52C36S	HWS	36	34	38	2	90	350	0.5	0.1	25.2	30.4	37.4	2
BZT52C39S	HWT	39	37	41	2	130	350	0.5	0.1	27.3	33.4	41.2	2

Notes:

1. Part mounted on FR-4 PC board with recommended pad layout, as per <http://www.diodes.com/datasheets/ap02001.pdf>.
2. Short duration test pulse used to minimize self-heating effect.
3. f = 1kHz.

电参数曲线图 / Electrical Characteristic Curve

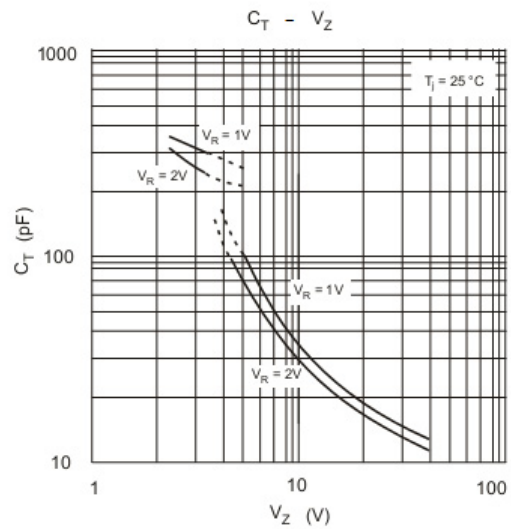
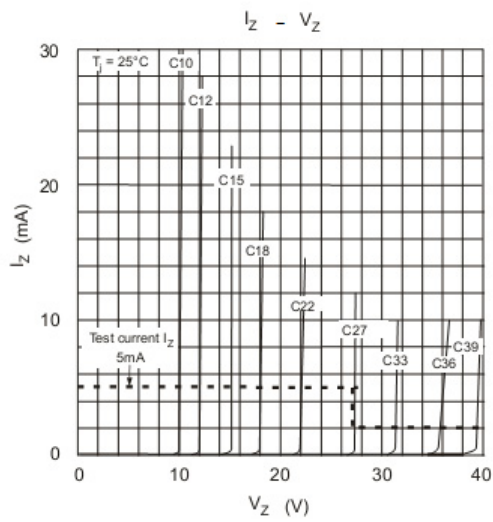
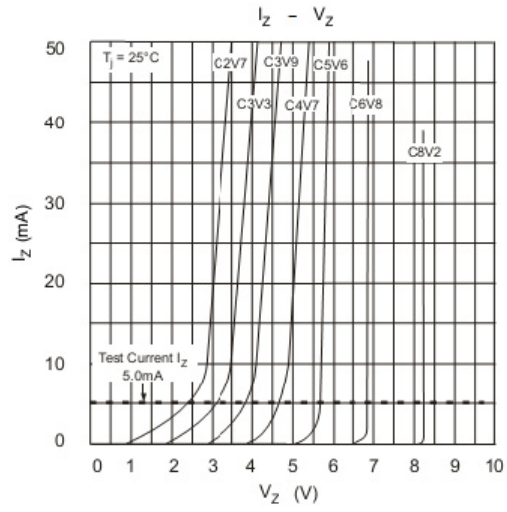
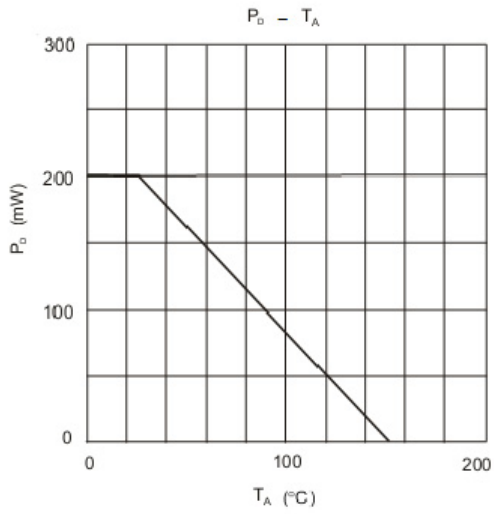

外形尺寸图 / Package Dimensions

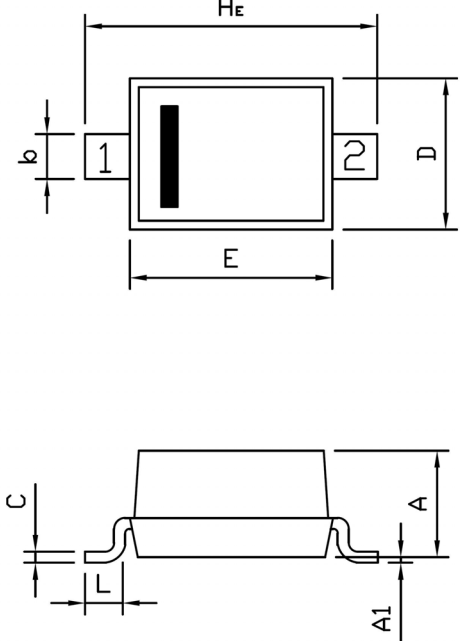

Unit: mm

尺寸 符号	SOD-323	
	min	max
A	0.85	1.15
A1	0.00	0.10
b	0.25	0.40
C	0.089	0.177
D	1.15	1.35
E	1.60	1.80
HE	2.30	2.70
L	0.20	0.40

PIN: 1.CATHODE 2.ANODE

SOD-323

印章说明 / Marking Instructions

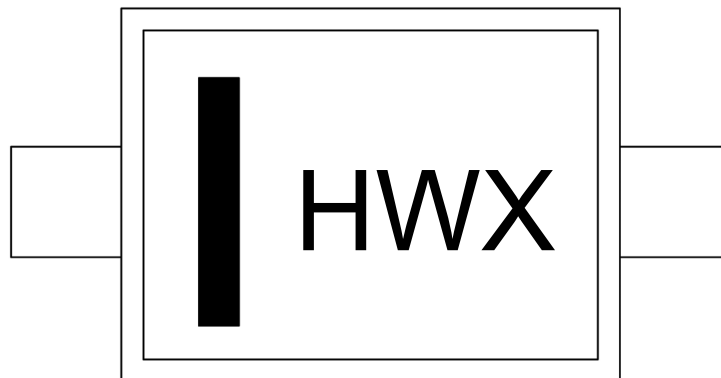

说明：

H： 为公司代码

WX： 为型号代码

Note:

H: Company Code.

WX: Product Type.

回流焊温度曲线图(无铅) / Temperature Profile for IR Reflow Soldering(Pb-Free)



说明：

- 1、预热温度 25 ~ 150°C，时间 60 ~ 90sec;
- 2、峰值温度 245±5°C，时间持续为 5±0.5sec;
- 3、焊接制程冷却速度为 2 ~ 10°C/sec.

Note:

- 1.Preheating:25~150°C, Time:60~90sec.
- 2.Peak Temp.:245±5°C, Duration:5±0.5sec.
3. Cooling Speed: 2~10°C/sec.

耐焊接热试验条件 / Resistance to Soldering Heat Test Conditions

温度：260±5°C

时间：10±1 sec.

Temp.:260±5°C

Time:10±1 sec

包装规格 / Packaging SPEC.

卷盘包装 / REEL

Package Type 封装形式	Units 包装数量					Dimension 包装尺寸 (unit: mm ³)		
	Units/Reel 只/卷盘	Reels/Inner Box 卷盘/盒	Units/Inner Box 只/盒	Inner Boxes/Outer Box 盒/箱	Units/Outer Box 只/箱	Reel	Inner Box 盒	Outer Box 箱
SOD-323	3,000	10	30,000	6	180,000	7" ×8	180×120×180	390×385×205

使用说明 / Notices

X-ON Electronics

Largest Supplier of Electrical and Electronic Components

Click to view similar products for [Zener Diodes](#) category:

Click to view products by [Blue Rocket](#) manufacturer:

Other Similar products are found below :

[RKZ13B2KG#P1](#) [DL5234B](#) [1N4682](#) [1N4693](#) [1N4732A](#) [1N4736A](#) [1N4750A](#) [1N4759ARL](#) [1N5241B](#) [1N5365B](#) [1N5369B](#) [1N747A](#)
[1N964B](#) [1N966B](#) [1N968B](#) [1N972B](#) [JANS1N4974US](#) [1N4692](#) [1N4702](#) [1N4704](#) [1N4711](#) [1N4714](#) [1N4745ARL](#) [1N4752ARL](#) [1N4760ARL](#)
[1N5221B](#) [1N5242BTR](#) [1N5350B](#) [1N5352B](#) [1N961BRR1](#) [1N964BRL](#) [RKZ5.1BKU#P6](#) [3SMAJ5946B-TP](#) [3SMAJ5950B-TP](#)
[MMSZ5230BQ-13-F](#) [MMSZ5232BQ-13-F](#) [BZX84C7V5](#) [3SMAJ5945B-TP](#) [3SMAJ5947B-TP](#) [3SMBJ5941B-TP](#) [DZ2S240M0L](#) [SMAZ27-](#)
[TP](#) [ZMM5224B-7](#) [RD16UM-T1-A](#) [RD39S-T1-A](#) [RD10S-T1-A](#) [CDZT2R5.6B](#) [1N4762A G](#) [Z1SMA18](#) [JANTX1N4553B](#)