

### 描述 / Descriptions

超快恢复二极管，反向电压：50V~600V，正向电流：1.0A，SMA 封装。  
Surface Mount Superfast Recovery Rectifier, Reverse Voltage: 50 to 600V, Forward Current: 1.0A, SMA package.

### 特征 / Features

玻璃钝化芯片，反向恢复时间快，无铅符合欧盟 RoHS 指令 2011/65/EU，适用于表面贴装。无卤产品。  
Glass Passivated Chip Junction, Superfast reverse recovery time, Lead free in comply with EU R0HS 2011/65/EU directives, For surface mounted applications. Halogen free product.

### 用途 / Applications

一般用途。  
General purpose.

### 内部等效电路 / Equivalent Circuit



### 引脚排列 / Pinning



PIN	DESCRIPTION
1	Cathode
2	Anode

The recommended mounting pad size

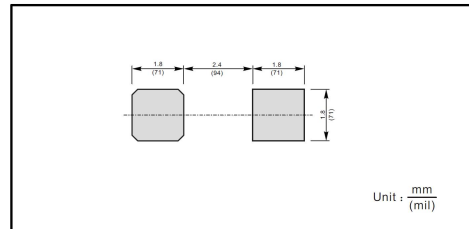

### 印章代码 / Marking

见印章说明。See Marking Instructions

**极限参数 / Absolute Maximum Ratings(Ta=25°C)**

参数 Parameter	符号 Symbol	数值 Rating							单位 Unit
		ES1A	ES1B	ES1C	ES1D	ES1E	ES1G	ES1J	
Maximum Repetitive Peak Reverse Voltage	$V_{RRM}$	50	100	150	200	300	400	600	V
Maximum RMS voltage	$V_{RMS}$	35	70	105	140	210	280	420	V
Maximum DC Blocking Voltage	$V_{DC}$	50	100	150	200	300	400	600	V
Maximum Average Forward Rectified Current	$I_{F(AV)}$	1.0							A
Peak Forward Surge Current 8.3 ms Single Half Sine Wave Superimposed on Rated Load (JEDEC Method)	$I_{FSM}$	30							A
Typical Junction Capacitance at $V_R=4V, f=1MHz$	$C_j$	15							pF
Typical Thermal Resistance <sup>1)</sup>	$R_{\theta JA}$	75							°C/W
Operating and Storage Temperature Range	$T_j, T_{stg}$	-55~+150							°C

Note:

1) P.C.B. mounted with 1.0X1.0"(2.54X2.54 cm) copper pad areas.

**电性能参数 / Electrical Characteristics(Ta=25°C)**

参数 Parameter	符号 Symbol	测试条件 Test Conditions	数值 Rating						单位 Unit
			ES1A	ES1B	ES1C	ES1D	ES1E	ES1G	
Maximum Forward Voltage	$V_F$	$I_F=1.0A$	1.0			1.25		1.70	V
Maximum DC Reverse Current at Rated DC Blocking Voltage	$I_R$	$T_a=25^\circ C$	5.0						$\mu A$
		$T_a=125^\circ C$	100						$\mu A$
Maximum Reverse Recovery Time	$t_{rr}$	$I_F=0.5A$ $I_R=1.0A$ $I_{rr}=0.25A$	35						ns

电参数曲线图 / Electrical Characteristic Curve

Fig.1 Reverse Recovery Time Characteristic And Test Circuit Diagram

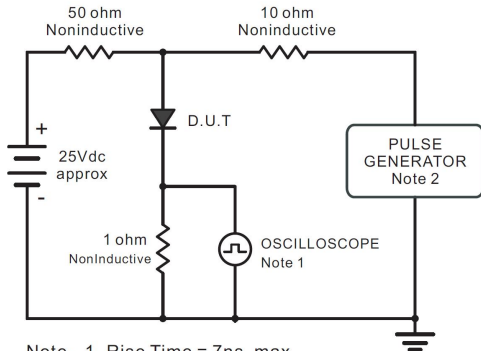

Note: 1. Rise Time = 7ns, max.  
Input Impedance = 1megohm, 22pF.  
2. Rise Time = 10ns, max.  
Source Impedance = 50 ohms.

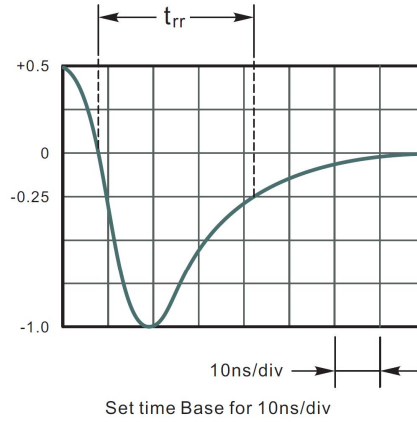

Fig.2 Maximum Average Forward Current Rating

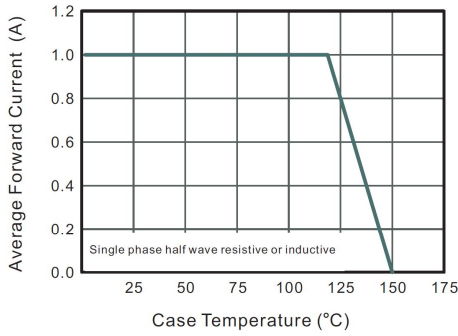

Fig.3 Typical Reverse Characteristics

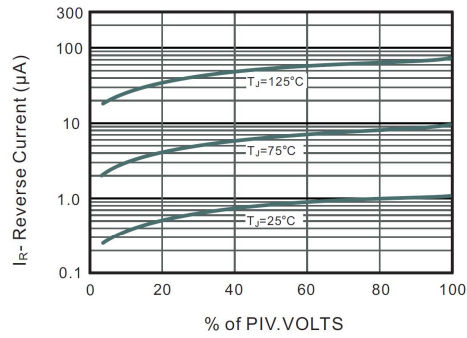

Fig.4 Typical Forward Characteristics

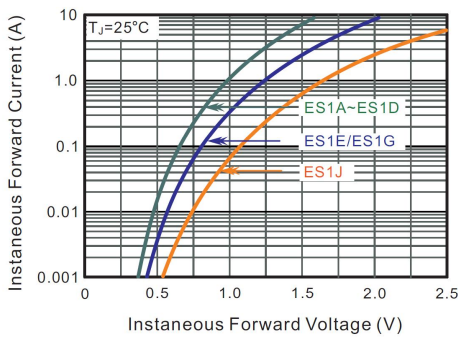

Fig.5 Typical Junction Capacitance

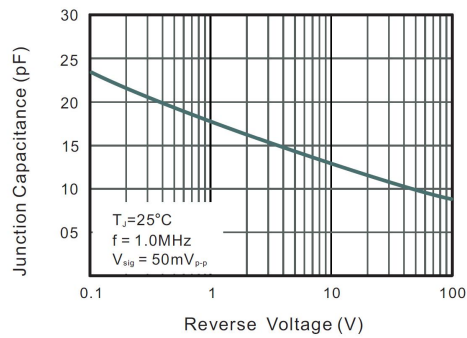
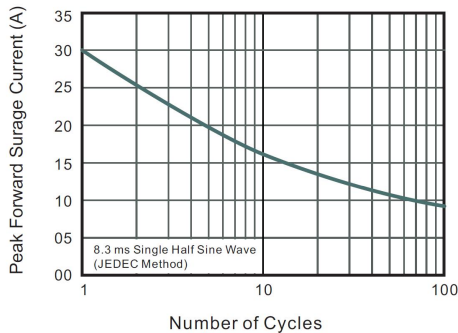
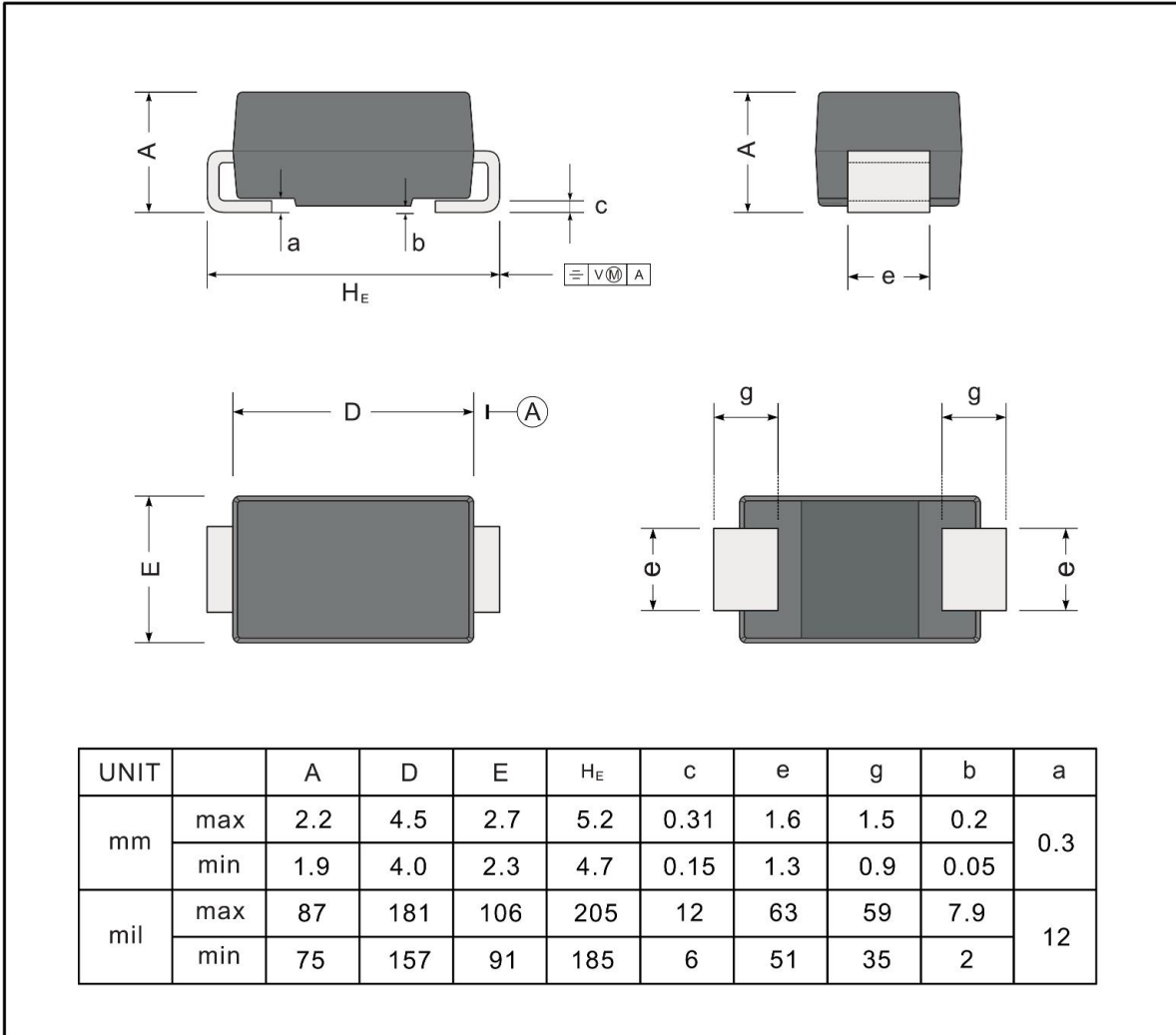

Fig.6 Maximum Non-Repetitive Peak Forward Surge Current



外形尺寸图 / Package Dimensions

SMA



# Marking

Type number	Marking code
ES1A	ES1A
ES1B	ES1B
ES1C	ES1C
ES1D	ES1D
ES1E	ES1E
ES1G	ES1G
ES1J	ES1J

印章说明 / Marking Instructions



说明：

ES1D： 为型号代码

\*\*\*\*： 为生产批号追溯码，第1个\*为年月代码，后面3个\*为当月小批号代码

Note:

ES1D： Product Type Code

\*\*\*\*： Lot No. Code ,The 1st \* means:YM Code ,The last 3 \* means:little Lot No  
Code

**回流焊温度曲线图(无铅) / Temperature Profile for IR Reflow Soldering(Pb-Free)**

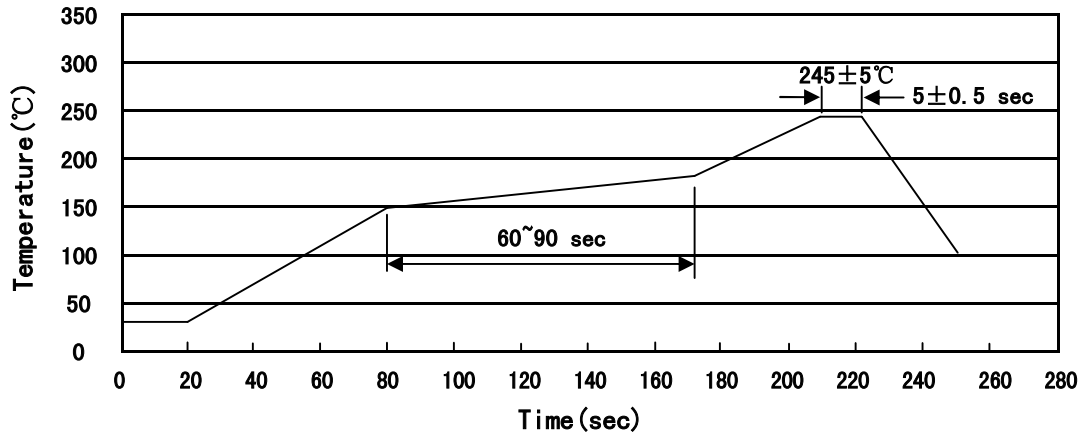

说明：

- 1、预热温度 150 ~ 180°C，时间 60 ~ 90sec;
- 2、峰值温度 245±5°C，时间持续为 5±0.5sec;
- 3、焊接制程冷却速度为 2 ~ 10°C/sec.

Note:

- 1.Preheating:150~180°C, Time:60~90sec.
- 2.Peak Temp.:245±5°C, Duration:5±0.5sec.
3. Cooling Speed: 2~10°C/sec.

**耐焊接热试验条件 / Resistance to Soldering Heat Test Conditions**

温度：260±5°C

时间：10±1 sec.

Temp.:260±5°C

Time:10±1 sec

**包装规格 / Packaging SPEC.**

卷盘包装 / REEL

Package Type 封装形式	Units 包装数量					Dimension 包装尺寸 (unit: mm <sup>3</sup> )		
	Units/Reel 只/卷盘	Reels/Inner Box 卷盘/盒	Units/Inner Box 只/盒	Inner Boxes/Outer Box 盒/箱	Units/Outer Box 只/箱	Reel	Inner Box 盒	Outer Box 箱
SMA	5000	2	10000	7	70000	13" ×12	336X336X40	380X335X366

**使用说明 / Notices**

## X-ON Electronics

Largest Supplier of Electrical and Electronic Components

*Click to view similar products for [Rectifiers](#) category:*

*Click to view products by [Blue Rocket](#) manufacturer:*

Other Similar products are found below :

[70HFR40](#) [FR105 R0](#) [RL252-TP](#) [1N5397](#) [1N4005-TR](#) [1N4007-BP](#) [UFS120Je3/TR13](#) [20ETS12S](#) [RRE02VS6SGTR](#) [MS306](#) [A1N5404G-G](#)  
[CRF02\(T5L,TEMQ\)](#) [ACGRB207-HF](#) [CLH07\(TE16L,Q\)](#) [CLH03\(TE16L,Q\)](#) [1N5395-TP](#) [UES1302](#) [ACGRC307-HF](#) [ACEFC304-HF](#) [DZ-](#)  
[1380](#) [85HFR60](#) [40HFR60](#) [70HF120](#) [85HFR80](#) [SCF7500](#) [SM100](#) [ACGRA4001-HF](#) [SKN70/08](#) [NTE5819](#) [NTE5827](#) [NTE5828](#) [NTE5911](#)  
[NTE5915](#) [NTE6104](#) [NTE6163](#) [NTE6164](#) [NTE6165](#) [NTE6364](#) [TSD3G](#) [SET130312](#) [NRVUS110VT3G](#) [UES1106](#) [UES1306](#)  
[NRVUS240VT3G](#) [D5FE60-5063](#) [R4000GPS-TP](#) [D4015L56TP](#) [UES1306HR2](#) [FX20K120](#) [D20XB60-7101](#)