

描述 / Descriptions

超快恢复二极管，反向电压：50V~600V，正向电流：2.0A，SMA 封装。
Surface Mount Superfast Recovery Rectifier, Reverse Voltage:50 to600V, Forward Current:2.0A, SMA package.

特征 / Features

玻璃钝化芯片，反向恢复时间快，无铅符合欧盟 RoHS 指令 2011/65/EU，适用于表面贴装。无卤产品。
Glass Passivated Chip Junction, Superfast reverse recovery time, Lead free in comply with EU R0HS 2011/65/EU directives, For surface mounted applications. Halogen free product.

用途 / Applications

一般用途。
General purpose.

内部等效电路 / Equivalent Circuit



引脚排列 / Pinning



PIN	DESCRIPTION
1	Cathode
2	Anode

The recommended mounting pad size

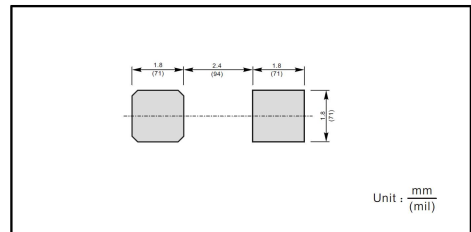

印章代码 / Marking

见印章说明。See Marking Instructions

极限参数 / Absolute Maximum Ratings(Ta=25°C)

参数 Parameter	符号 Symbol	数值 Rating							单位 Unit
		ES2A	ES2B	ES2C	ES2D	ES2E	ES2G	ES2J	
Maximum Repetitive Peak Reverse Voltage	V_{RRM}	50	100	150	200	300	400	600	V
Maximum RMS voltage	V_{RMS}	35	70	105	140	210	280	420	V
Maximum DC Blocking Voltage	V_{DC}	50	100	150	200	300	400	600	V
Maximum Average Forward Rectified Current at $T_c = 125^\circ C$	$I_{F(AV)}$	2.0							A
Peak Forward Surge Current 8.3 ms Single Half Sine Wave Superimposed on Rated Load	I_{FSM}	50							A
Typical Junction Capacitance at $V_R = 4V, f = 1MHz$	C_j	40							pF
Typical Thermal Resistance ¹⁾	$R_{\theta JA}$	60							°C/W
Operating and Storage Temperature Range	T_j, T_{stg}	-55~+150							°C

1) P.C.B. mounted with 1.0 X 1.0" (2.54 X 2.54 cm) copper pad areas.

电性能参数 / Electrical Characteristics(Ta=25°C)

参数 Parameter	符号 Symbol	测试条件 Test Conditions	数值 Rating							单位 Unit
			ES2A	ES2B	ES2C	ES2D	ES2E	ES2G	ES2J	
Maximum Forward Voltage	V_F	$I_F = 2.0A$	1.0			1.25		1.68	V	
Maximum DC Reverse Current at Rated DC Blocking Voltage	I_R	$T_a = 25^\circ C$	5.0							μA
		$T_a = 125^\circ C$	100							μA
Maximum Reverse Recovery Time	t_{rr}	$I_F = 0.5A$ $I_R = 1.0A$ $I_{rr} = 0.25A$	35							ns

电参数曲线图 / Electrical Characteristic Curve

Fig.1 Reverse Recovery Time Characteristic And Test Circuit Diagram

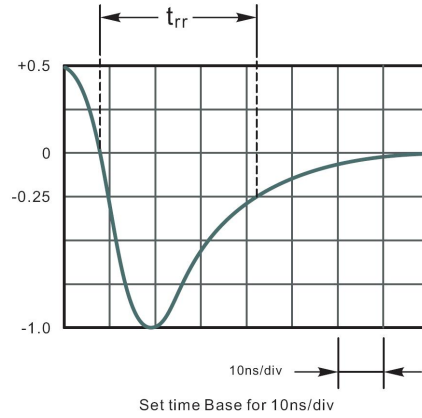
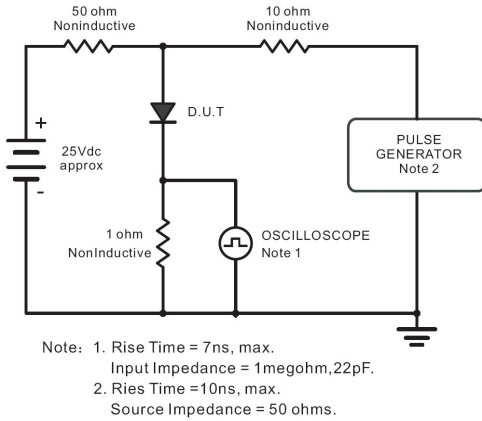

Fig.2 Maximum Average Forward Current Rating

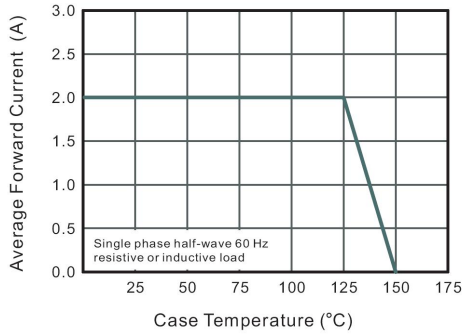

Fig.3 Typical Reverse Characteristics

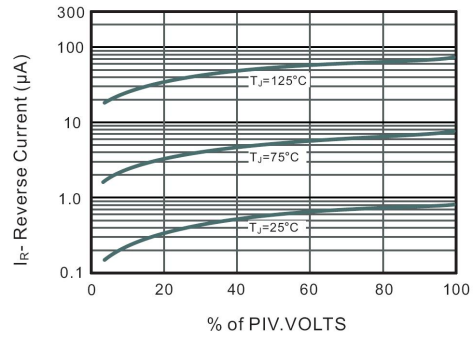

Fig.4 Typical Forward Characteristics

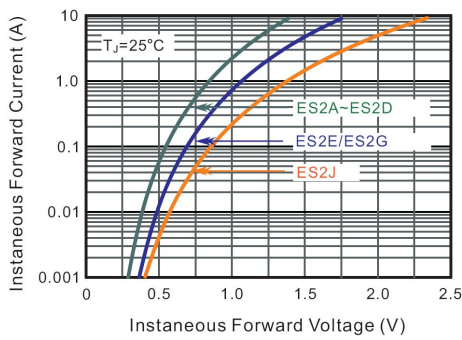

Fig.5 Typical Junction Capacitance

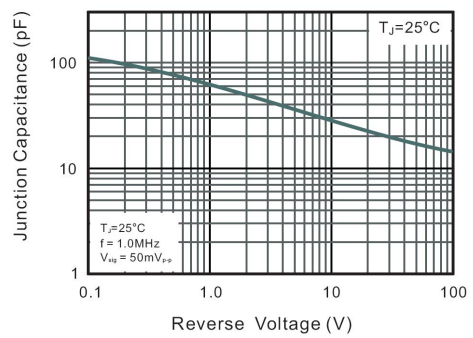
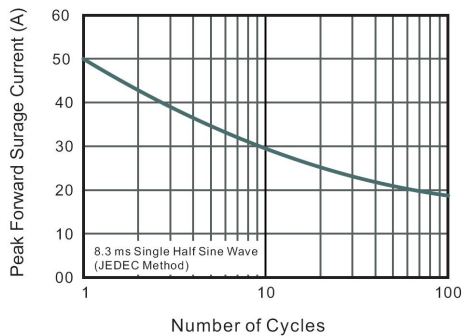
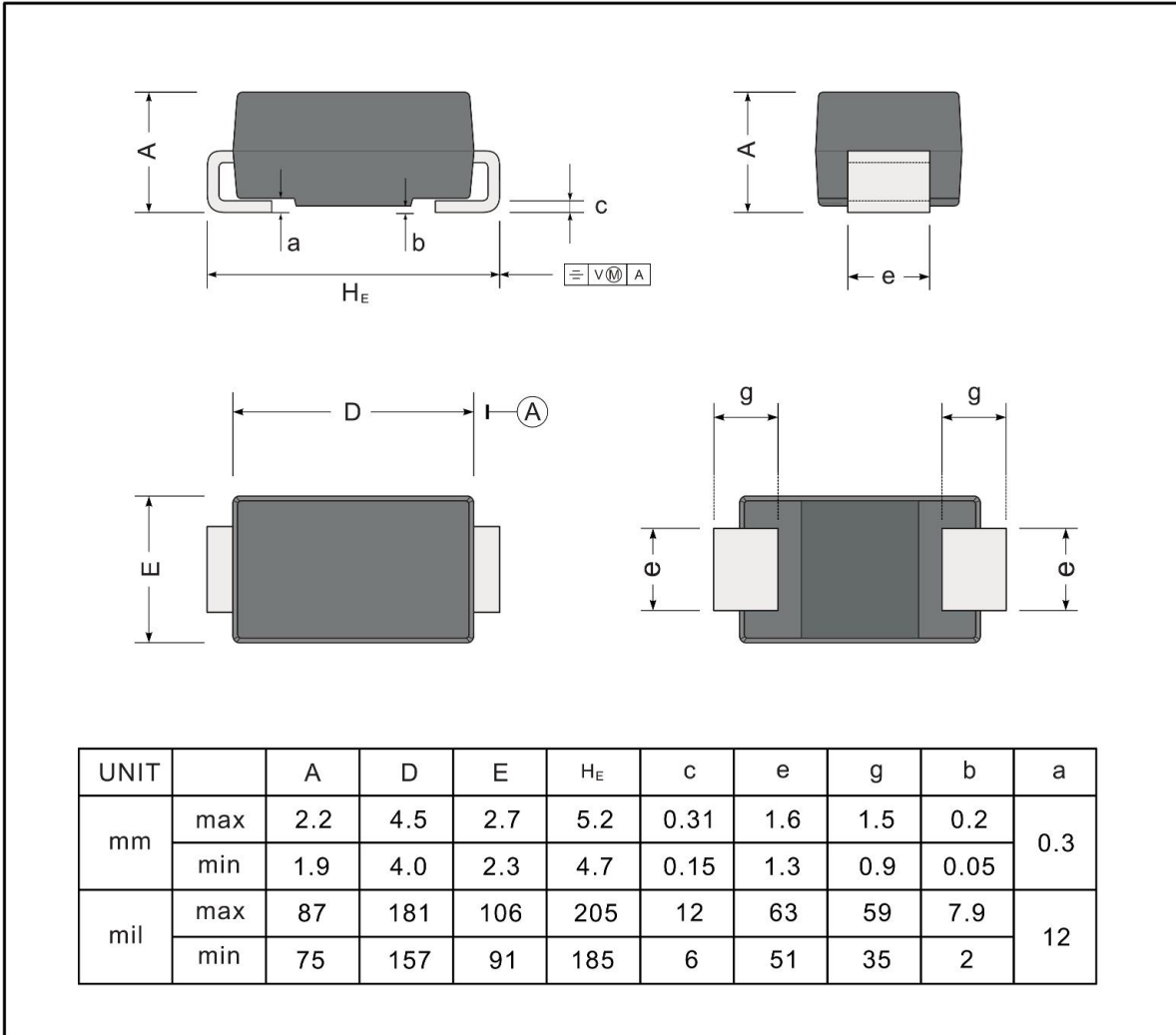

Fig.6 Maximum Non-Repetitive Peak Forward Surge Current



外形尺寸图 / Package Dimensions

SMA



Marking

Type number	Marking code
ES2A	ES2A
ES2B	ES2B
ES2C	ES2C
ES2D	ES2D
ES2E	ES2E
ES2G	ES2G
ES2J	ES2J

印章说明 / Marking Instructions



说明：

ES2A： 为型号代码

****： 为生产批号追溯码，第1个*为年月代码，后面3个*为当月小批号代码

Note:

ES2A： Product Type Code

****： Lot No. Code ,The 1st * means:YM Code ,The last 3 * means:little Lot No
Code

回流焊温度曲线图(无铅) / Temperature Profile for IR Reflow Soldering(Pb-Free)

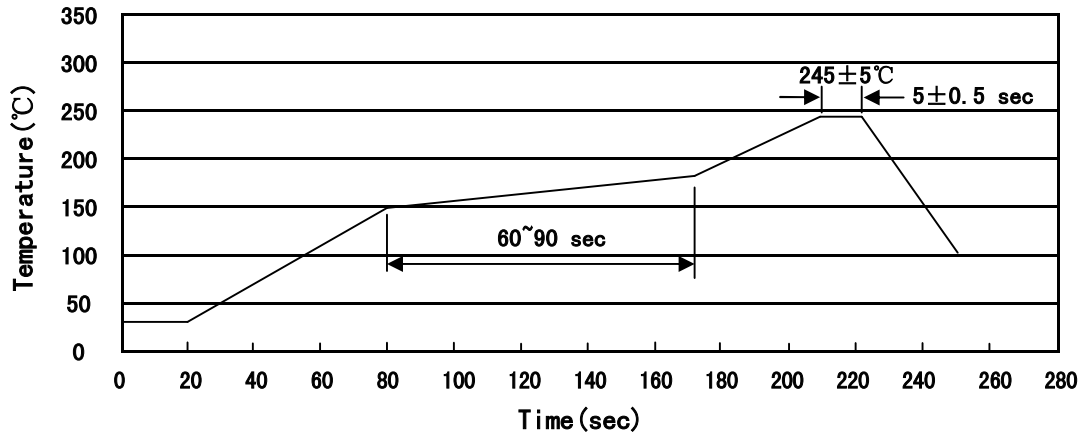

说明：

- 1、预热温度 150 ~ 180°C，时间 60 ~ 90sec;
- 2、峰值温度 245±5°C，时间持续为 5±0.5sec;
- 3、焊接制程冷却速度为 2 ~ 10°C/sec.

Note:

- 1.Preheating:150~180°C, Time:60~90sec.
- 2.Peak Temp.:245±5°C, Duration:5±0.5sec.
3. Cooling Speed: 2~10°C/sec.

耐焊接热试验条件 / Resistance to Soldering Heat Test Conditions

温度：260±5°C

时间：10±1 sec.

Temp.:260±5°C

Time:10±1 sec

包装规格 / Packaging SPEC.

卷盘包装 / REEL

Package Type 封装形式	Units 包装数量					Dimension 包装尺寸 (unit: mm ³)		
	Units/Reel 只/卷盘	Reels/Inner Box 卷盘/盒	Units/Inner Box 只/盒	Inner Boxes/Outer Box 盒/箱	Units/Outer Box 只/箱	Reel	Inner Box 盒	Outer Box 箱
SMA	5000	2	10000	7	70000	13" ×12	336X336X40	380X335X366

使用说明 / Notices

X-ON Electronics

Largest Supplier of Electrical and Electronic Components

Click to view similar products for [Rectifiers](#) category:

Click to view products by [Blue Rocket](#) manufacturer:

Other Similar products are found below :

[70HFR40](#) [FR105 R0](#) [RL252-TP](#) [1N5397](#) [1N4005-TR](#) [1N4007-BP](#) [UFS120Je3/TR13](#) [20ETS12S](#) [RRE02VS6SGTR](#) [MS306](#) [A1N5404G-G](#)
[CRF02\(T5L,TEMQ\)](#) [ACGRB207-HF](#) [CLH07\(TE16L,Q\)](#) [CLH03\(TE16L,Q\)](#) [1N5395-TP](#) [UES1302](#) [ACGRC307-HF](#) [ACEFC304-HF](#) [DZ-](#)
[1380](#) [85HFR60](#) [40HFR60](#) [70HF120](#) [85HFR80](#) [SCF7500](#) [SM100](#) [ACGRA4001-HF](#) [SKN70/08](#) [NTE5819](#) [NTE5827](#) [NTE5828](#) [NTE5911](#)
[NTE5915](#) [NTE6104](#) [NTE6163](#) [NTE6164](#) [NTE6165](#) [NTE6364](#) [TSD3G](#) [SET130312](#) [NRVUS110VT3G](#) [UES1106](#) [UES1306](#)
[NRVUS240VT3G](#) [D5FE60-5063](#) [R4000GPS-TP](#) [D4015L56TP](#) [UES1306HR2](#) [FX20K120](#) [D20XB60-7101](#)