

### 描述 / Descriptions

表面贴装整流二极管，反向电压：50V~1000V，正向电流：1.0A，薄型 SMAF 封装。

Surface Mount General Purpose Silicon Rectifiers,Reverse Voltage:50 to1000V,Forward Current:1.0A,SMAF thin package.

### 特征 / Features

玻璃钝化芯片，无铅符合欧盟 RoHS 指令 2011/65/EU；适用于表面贴装，便于优化设计。无卤产品。

Glass Passivated Chip Junction,Lead free in comply with EU RoHS 2011/65/EU directives,For surface mounted applications,Easy to pick and place.Halogen free product.

### 用途 / Applications

一般用途.

General purpose.

### 内部等效电路 / Equivalent Circuit



### 引脚排列 / Pinning



PIN	DESCRIPTION
1	Cathode
2	Anode

The recommended mounting pad size

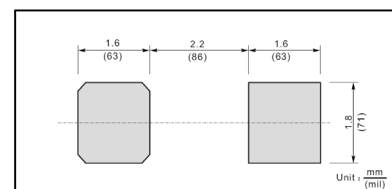

### 印章代码 / Marking

见印章说明。 See Marking Instructions.

**极限参数 / Absolute Maximum Ratings(Ta=25°C)**

参数 Parameter	符号 Symbol	数值 Rating							单位 Unit
		M1	M2	M3	M4	M5	M6	M7	
Maximum Repetitive Peak Reverse Voltage	$V_{RRM}$	50	100	200	400	600	800	1000	V
Maximum RMS Voltage	$V_{RMS}$	35	70	140	280	420	560	700	V
Maximum DC Blocking Voltage	$V_{DC}$	50	100	200	400	600	800	1000	V
Maximum Average Forward Rectified Current at $T_a = 65^\circ\text{C}$	$I_{F(AV)}$	1.0							A
Peak Forward Surge Current 8.3ms Single Half Sine Wave Superimposed on Rated Load (JEDEC Method)	$I_{FSM}$	30							A
Typical Junction Capacitance <sup>1)</sup>	$C_j$	9.0							pF
Typical Thermal Resistance <sup>2)</sup>	$R_{\theta JA}$	115							$^\circ\text{C/W}$
Operating and Storage Temperature Range	$T_j, T_{stg}$	-55~+150							$^\circ\text{C/W}$

Note:

- 1). Measured at 1 MHz and applied reverse voltage of 4 V.D.C
- 2). P.C.B. mounted with 0.2X0.2"(5X5mm) copper pad areas.

**电性能参数 / Electrical Characteristics(Ta=25°C)**

参数 Parameter	符号 Symbol	测试条件 Test Conditions	数值 Rating							单位 Unit
			M1	M2	M3	M4	M5	M6	M7	
Maximum Instantaneous Forward Voltage	$V_F$	$I_F=1.0\text{A}$	1.1							V
Maximum DC Reverse Current at Maximum DC Blocking Voltage	$I_R$	$T_a=25^\circ\text{C}$	5.0							$\mu\text{A}$
		$T_a=125^\circ\text{C}$	50							$\mu\text{A}$

电参数曲线图 / Electrical Characteristic Curve

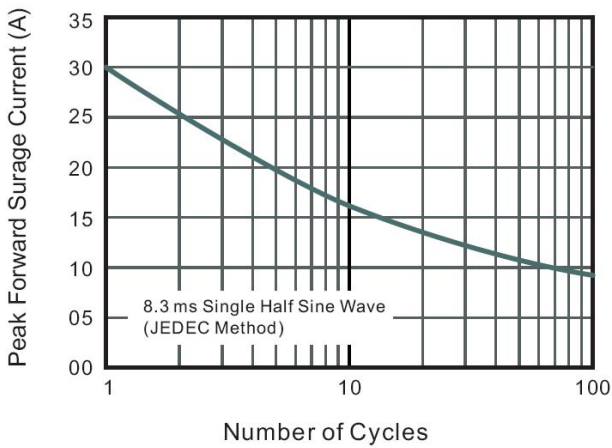
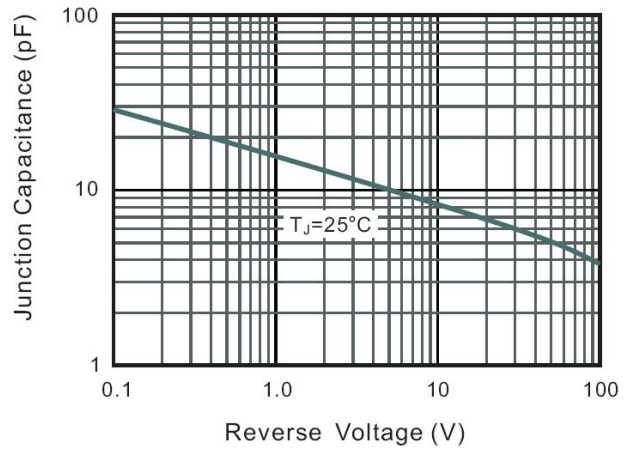
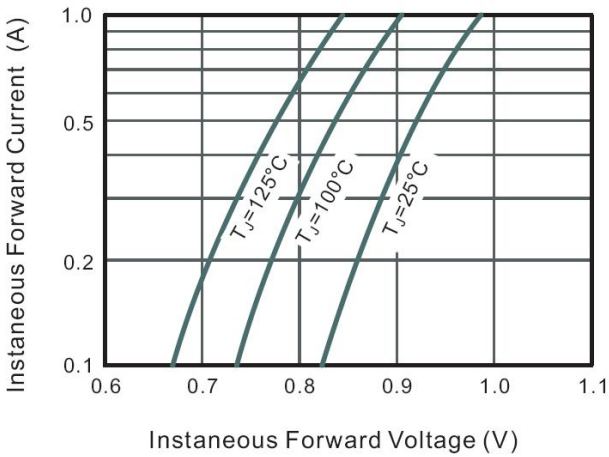
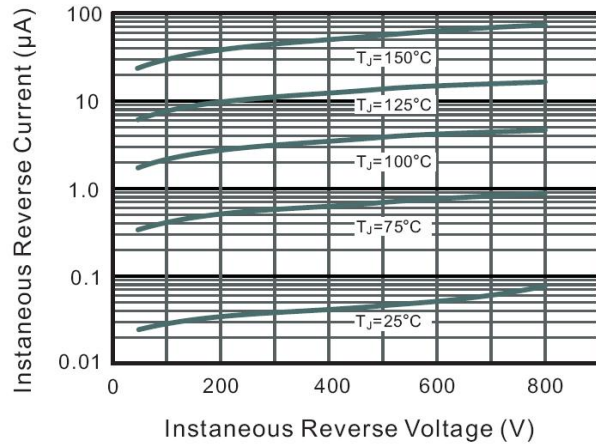
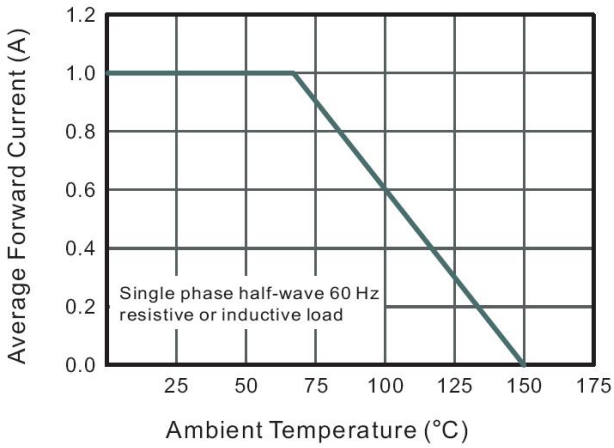

外形尺寸图 / Package Dimensions

SMAF

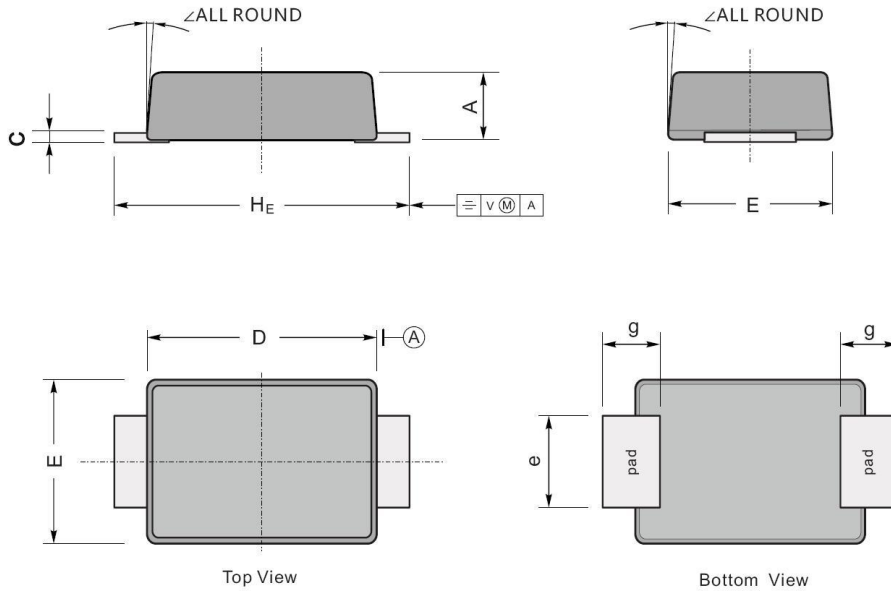

UNIT		A	C	D	E	e	g	$H_E$	$\angle$
mm	max	1.2	0.20	3.7	2.7	1.6	1.2	4.9	7°
	min	0.9	0.12	3.3	2.4	1.3	0.8	4.4	
mil	max	47	7.9	146	106	63	47	193	
	min	35	4.7	130	94	51	31	173	

## Marking

Type number	Marking code
M1	M1
M2	M2
M3	M3
M4	M4
M5	M5
M6	M6
M7	M7

印章说明 / Marking Instructions

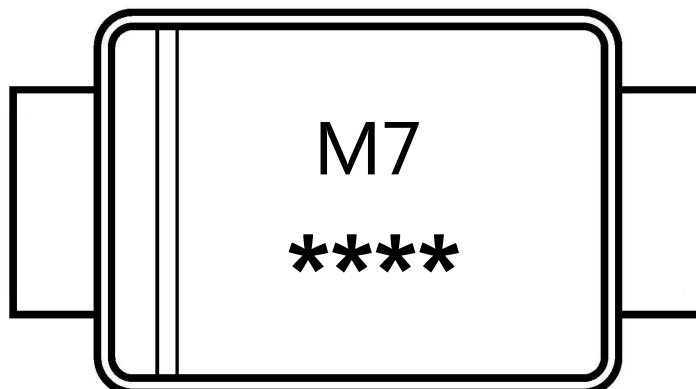

说明：

M7： 为型号代码

\*\*\*\*： 为生产批号追溯码，第1个\*为年月代码，后面3个\*为当月小批号代码

Note:

M7： Product Type Code

\*\*\*\*： Lot No. Code ,The 1st \* means:YM Code ,The last 3 \* means:little Lot No Code

**回流焊温度曲线图(无铅) / Temperature Profile for IR Reflow Soldering(Pb-Free)**



说明：

- 1、预热温度 25 ~ 150°C，时间 60 ~ 90sec;
- 2、峰值温度 245±5°C，时间持续为 5±0.5sec;
- 3、焊接制程冷却速度为 2 ~ 10°C/sec.

Note:

- 1.Preheating:25~150°C, Time:60~90sec.
- 2.Peak Temp.:245±5°C, Duration:5±0.5sec.
3. Cooling Speed: 2~10°C/sec.

**耐焊接热试验条件 / Resistance to Soldering Heat Test Conditions**

温度：260±5°C

时间：10±1 sec.

Temp.:260±5°C

Time:10±1 sec

**包装规格 / Packaging SPEC.**

卷盘包装 / REEL

Package Type 封装形式	Units 包装数量					Dimension 包装尺寸 (unit: mm <sup>3</sup> )		
	Units/Reel 只/卷盘	Reels/Inner Box 卷盘/盒	Units/Inner Box 只/盒	Inner Boxes/Outer Box 盒/箱	Units/Outer Box 只/箱	Reel	Inner Box 盒	Outer Box 箱
SMAF	3000	5	15000	5	75000	7" ×11	185X180X105	390X385X205

**使用说明 / Notices**

## X-ON Electronics

Largest Supplier of Electrical and Electronic Components

*Click to view similar products for* [Diodes - General Purpose, Power, Switching category:](#)

*Click to view products by* [Blue Rocket manufacturer:](#)

Other Similar products are found below :

[MCL4151-TR3](#) [MMBD3004S-13-F](#) [RD0306T-H](#) [RD0506LS-SB-1H](#) [RGP30G-E373](#) [DSE010-TR-E](#) [BAQ333-TR](#) [BAQ335-TR](#) [BAQ33-GS18](#) [BAS1602VH6327XT](#) [BAV17-TR](#) [BAV19-TR](#) [BAV301-TR](#) [BAW27-TAP](#) [HSC285TRF-E](#) [NSVBAV23CLT1G](#) [NTE525](#) [1SS181-TP](#) [1SS184-TP](#) [1SS193,LF](#) [1SS193-TP](#) [1SS400CST2RA](#) [SBAV99LT3G](#) [SDAA13](#) [LL4448-GS18](#) [SHN2D02FUTW1T1G](#) [LS4150GS18](#) [LS4151GS08](#) [SMMD7000LT3G](#) [FC903-TR-E](#) [1N4449](#) [1N4934-E3/73](#) [1SS226-TP](#) [APT100DL60HJ](#) [RFUH20TB3S](#) [RGP30G-E354](#) [RGP30M-E3/73](#) [D291S45T](#) [MCL4151-TR](#) [BAS 16-02V H6327](#) [BAS 21U E6327](#) [BAS 28 E6327](#) [BAS33-TAP](#) [BAS 70-02V H6327](#) [BAV300-TR](#) [BAV303-TR3](#) [BAW27-TR](#) [BAW56DWQ-7-F](#) [BAW56M3T5G](#) [BAW75-TAP](#)