

# MBRF20150CT

Rev.F Mar.-2016

## 描述 / Descriptions

TO-220F 塑料封装 肖特基二极管。  
Schottky Diode in a TO-220F Plastic Package.

## 特征 / Features

损耗低，效率高。  
Low power loss,high efficiency.

## 用途 / Applications

用于高频、低压、大电流整流二极管、续流二极管、保护二极管。  
For use in low voltage,high frequency inverters, free wheeling, and polarity protection applications.

## 内部等效电路 / Equivalent Circuit

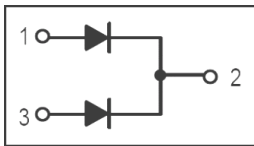

## 引脚排列 / Pinning



PIN 1 : Anode      PIN 2 : Cathode      PIN 3 : Anode

## 放大及印章代码 / $h_{FE}$ Classifications & Marking

见印章说明。 See Marking Instructions

**极限参数 / Absolute Maximum Ratings(Ta=25°C)**

参数 Parameter	符号 Symbol	数值 Rating	单位 Unit
Peak Repetitive Reverse Voltage	$V_{RRM}$	150	V
RMS Forward Current	$I_{F(RMS)}$	30	A
Average Forward Current	$I_{F(AV)}$	10	A
Average Forward Current	$I_{F(AV)}$ total device	20	A
Non Repetitive Peak Surge Current	$I_{FSM}$	180	A
Thermal Resistance Junction to Case	$R_{\theta Jc}$	1.5	°C/W
Junction Temperature Range	$T_j$	150	°C
Storage Temperature Range	$T_{stg}$	-55~150	°C

**电性能参数 / Electrical Characteristics(Ta=25°C)**

参数 Parameter	符号 Symbol	测试条件 Test Conditions	最小值 Min	典型值 Typ	最大值 Max	单位 Unit	
Forward Voltage	$V_F$	$I_F=10A(T_c=25^\circ C)$			0.9	V	
		$I_F=10A(T_c=125^\circ C)$		0.69	0.75	V	
		$I_F=20A(T_c=25^\circ C)$				1.0	V
		$I_F=20A(T_c=125^\circ C)$			0.79	0.86	V
Instantaneous Reverse Current	$I_R$	$V_R=150V(T_c=25^\circ C)$			5.0	$\mu A$	
		$V_R=150V(T_c=125^\circ C)$			5.0	mA	
Critical rate of rise of reverse voltage	dv/dt				10000	V/ $\mu s$	

电参数曲线图 / Electrical Characteristic Curve

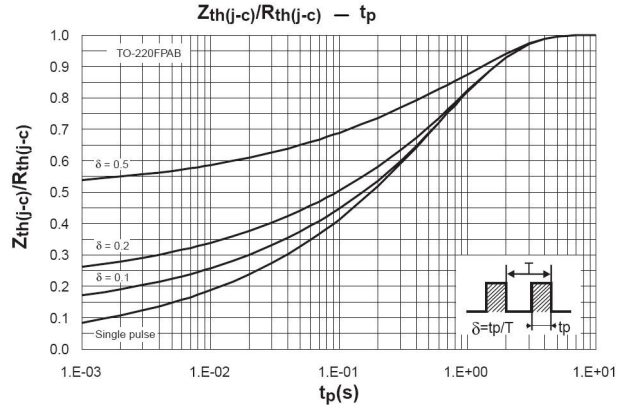
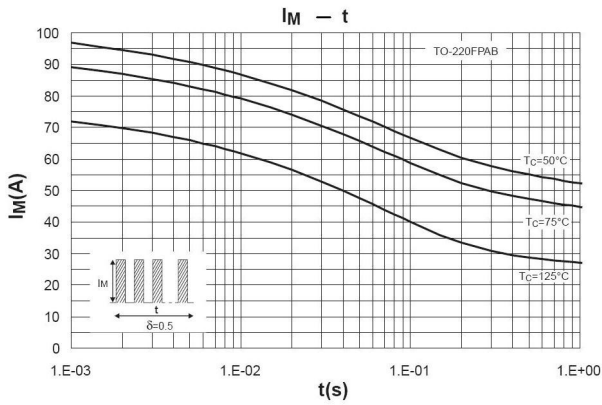
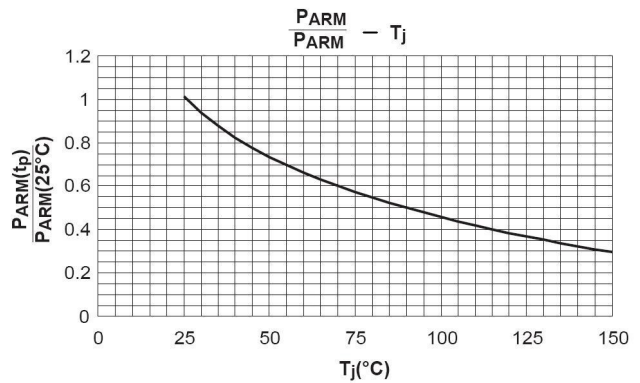
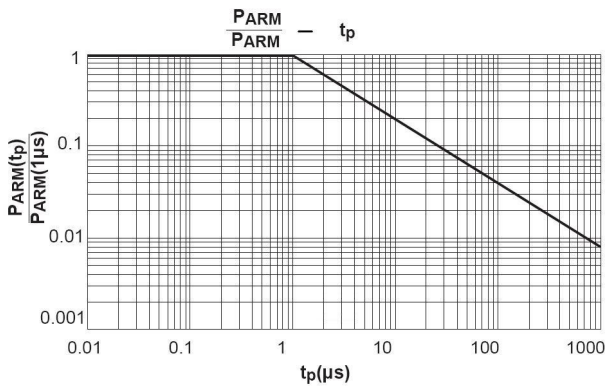
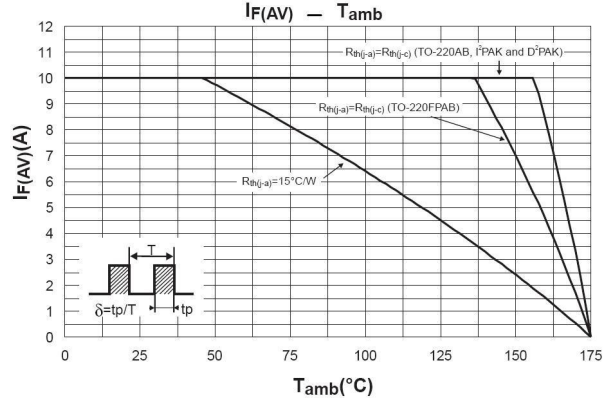
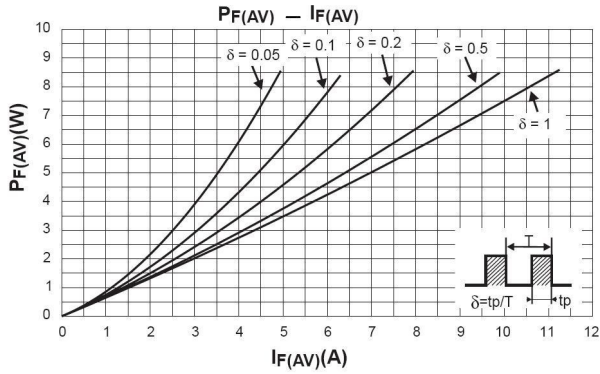

**电参数曲线图 / Electrical Characteristic Curve**

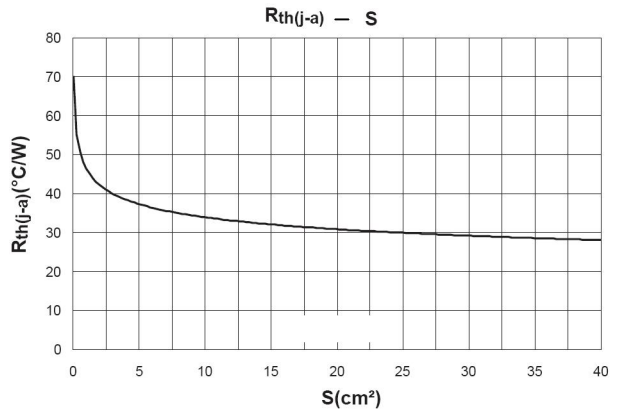
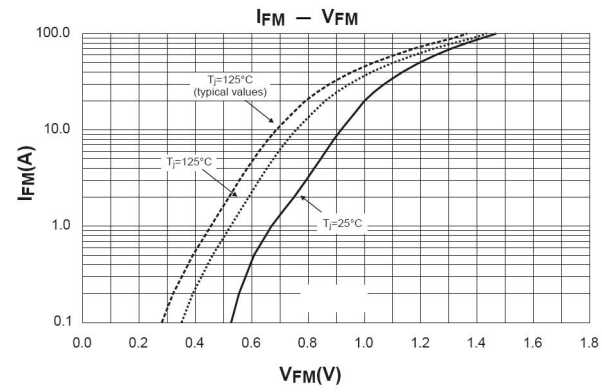
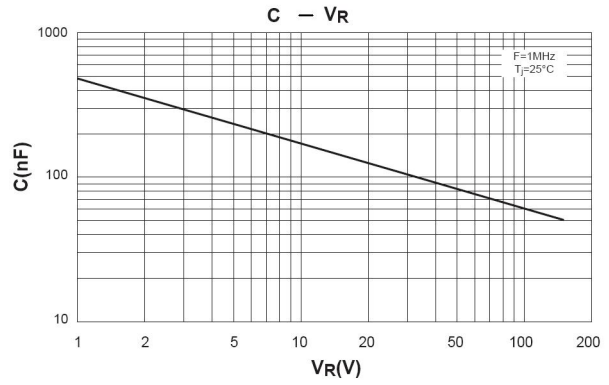
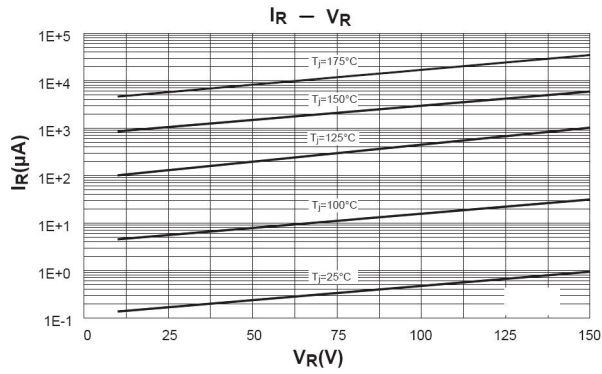

外形尺寸图 / Package Dimensions

TO-220F

单位: mm

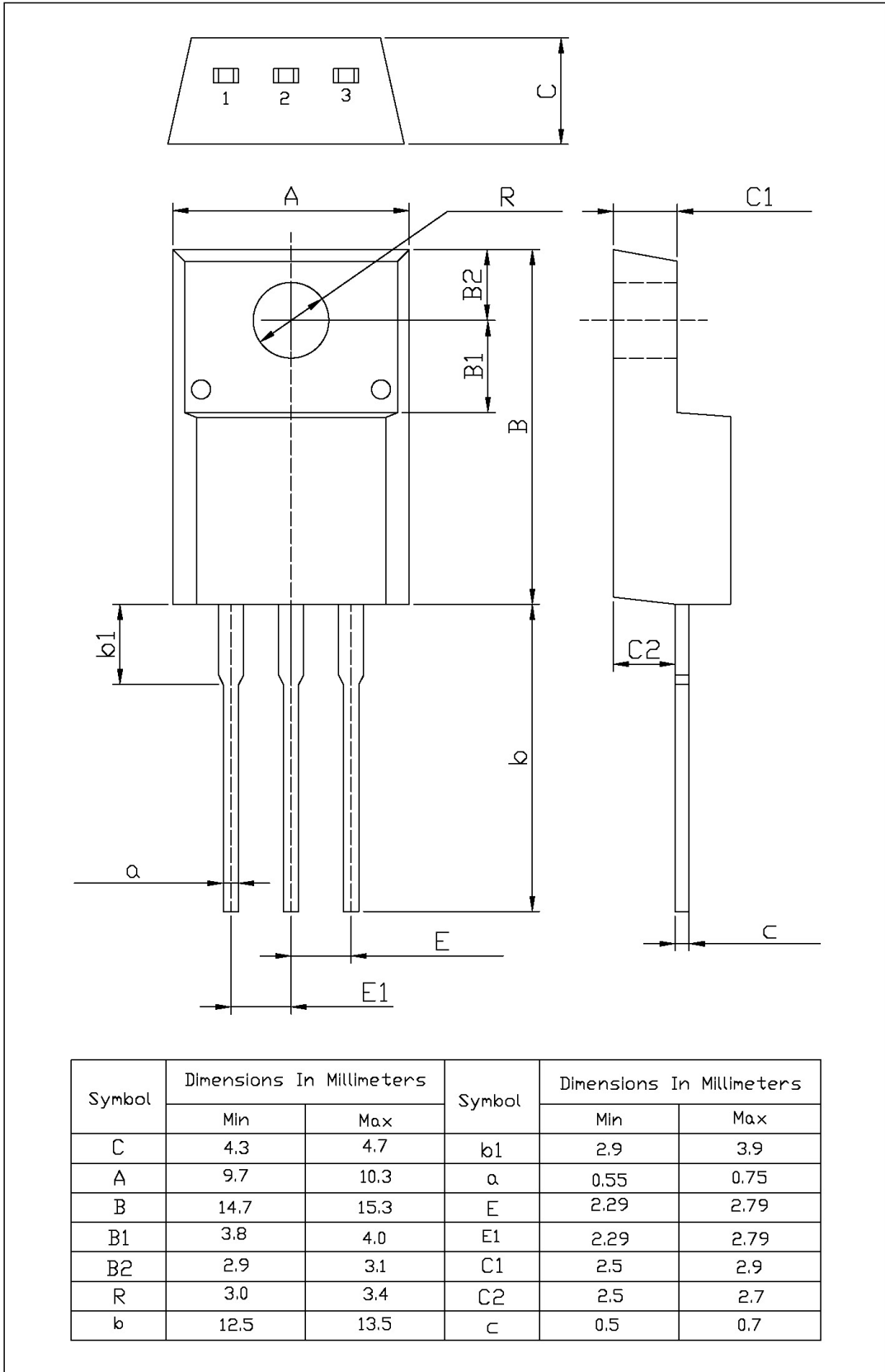

Symbol	Dimensions In Millimeters		Symbol	Dimensions In Millimeters	
	Min	Max		Min	Max
C	4.3	4.7	b1	2.9	3.9
A	9.7	10.3	a	0.55	0.75
B	14.7	15.3	E	2.29	2.79
B1	3.8	4.0	E1	2.29	2.79
B2	2.9	3.1	C1	2.5	2.9
R	3.0	3.4	C2	2.5	2.7
b	12.5	13.5	c	0.5	0.7

## 印章说明 / Marking Instructions

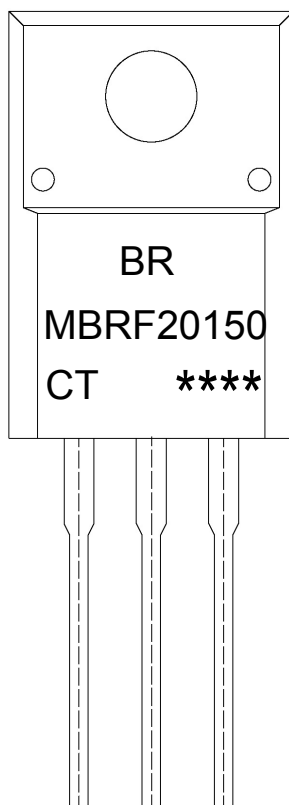

说明：

BR： 为公司代码

MBRF20150： 为产品型号

CT： 为内部结构

\*\*\*\*： 为生产批号代码，随生产批号变化。

Note:

BR: Company Code

MBRF20150: Product Type.

CT: Internal Structure

\*\*\*\*: Lot No. Code, code change with Lot No.

**波峰焊温度曲线图(无铅) / Temperature Profile for Dip Soldering(Pb-Free)**

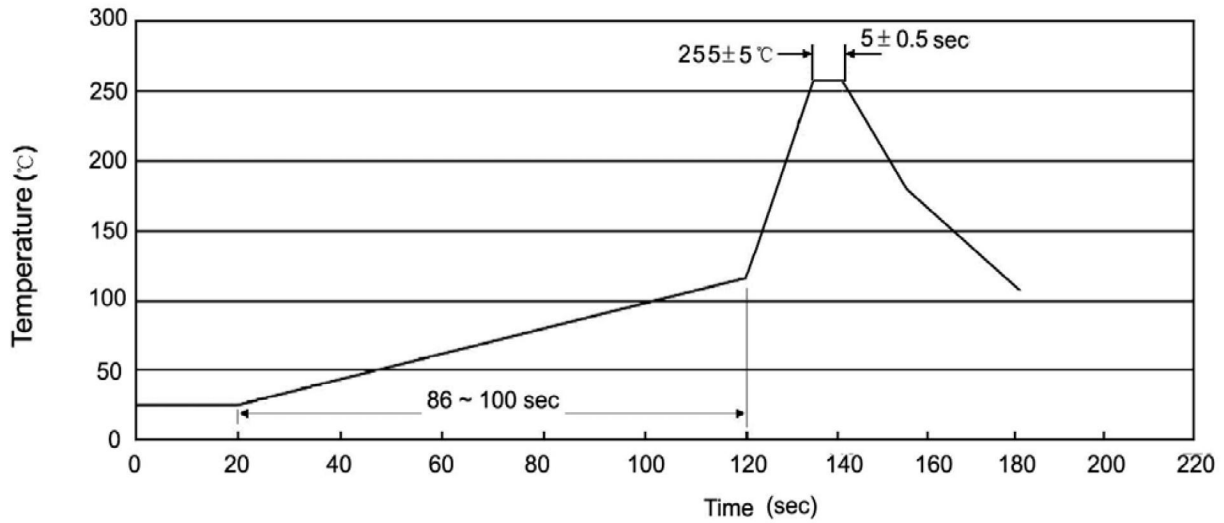

说明：

- 1、预热温度 25 ~ 150°C，时间 60 ~ 90sec;
- 2、峰值温度 255±5°C，时间持续为 5±0.5sec;
- 3、焊接制程冷却速度为 2 ~ 10°C/sec.

Note:

- 1.Preheating:25~150°C, Time:60~90sec.
- 2.Peak Temp.:255±5°C, Duration:5±0.5sec.
3. Cooling Speed: 2~10°C/sec.

**耐焊接热试验条件 / Resistance to Soldering Heat Test Conditions**

温度：270±5°C

时间：10±1 sec.

Temp.:270±5°C

Time:10±1 sec

**包装规格 / Packaging SPEC.**

散件包装 / BULK

Package Type 封装形式	Units 包装数量					Dimension 包装尺寸 (unit: mm <sup>3</sup> )		
	Units/Bag 只/袋	Bags/Inner Box 袋/盒	Units/Inner Box 只/盒	Inner Boxes/Outer Box 盒/箱	Units/Outer Box 只/箱	Bag 袋	Inner Box 盒	Outer Box 箱
TO-220/F	200	10	2,000	5	10,000	135×190	237×172×102	560×245×195

套管包装 / TUBE

Package Type 封装形式	Units 包装数量					Dimension 包装尺寸 (unit: mm <sup>3</sup> )		
	Units/Tube 只/套管	Tubes/Inner Box 套管/盒	Units/Inner Box 只/盒	Inner Boxes/Outer Box 盒/箱	Units/Outer Box 只/箱	Tube 套管	Inner Box 盒	Outer Box 箱
TO-220/F	50	20	1,000	5	5,000	532×31.4×5.5	555×164×50	575×290×180

**使用说明 / Notices**

## X-ON Electronics

Largest Supplier of Electrical and Electronic Components

*Click to view similar products for [Schottky Diodes & Rectifiers](#) category:*

*Click to view products by [Blue Rocket](#) manufacturer:*

Other Similar products are found below :

[MA4E2039](#) [MA4E2508M-1112](#) [MBR1545CT](#) [MMBD301M3T5G](#) [RB160M-50TR](#) [D83C](#) [BAS16E6433HTMA1](#) [BAT 54-02LRH E6327](#)  
[NRVBAF360T3G](#) [NSR05F40QNXT5G](#) [NTE555](#) [JANS1N6640](#) [SK310-T](#) [SS3003CH-TL-E](#) [GA01SHT18](#) [CRS10I30A\(TE85L,QM](#)  
[MA4E2501L-1290](#) [MBRA140TRPBF](#) [MBRB30H30CT-1G](#) [BAT 15-04R E6152](#) [JANTX1N5712-1](#) [DMJ3940-000](#) [SB007-03C-TB-E](#)  
[SK33B-TP](#) [NRVBB20100CTT4G](#) [NRVBM120LT1G](#) [NTSB30U100CT-1G](#) [VS-6CWQ10FNHM3](#) [CRG04\(T5L,TEMQ\)](#) [ACDBA1100LR-HF](#)  
[ACDBA1200-HF](#) [ACDBA240-HF](#) [ACDBA3100-HF](#) [CDBQC0530L-HF](#) [CDBQC0240LR-HF](#) [ACDBA260LR-HF](#) [ACDBA1100-HF](#)  
[MA4E2502L-1246](#) [10BQ015-M3/5BT](#) [NRVBM120ET1G](#) [CRS08TE85LQM](#) [PMAD1108-LF](#) [B120Q-13-F](#) [1N5819T-G](#) [B0530WSQ-7-F](#)  
[PDS1040Q-13](#) [B160BQ-13-F](#) [SDM05U20CSP-7](#) [B140S1F-7](#) [HSM560Je3/TR13](#)