

## 描述 / Descriptions

TO-92 塑封封装 NPN 半导体三极管。Silicon NPN transistor in a TO-92 Plastic Package.

## 特征 / Features

耐压高，快速转换。无卤产品。

High Voltage Capability High Speed Switching. HF Product.

## 用途 / Applications

主要用于节能灯、日光灯电子镇流器及其它开关、振荡电路。

High frequency electronic lighting ballast applications, converters, inverters, switching regulators, etc.

## 内部等效电路 / Equivalent Circuit

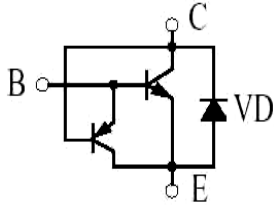

## 引脚排列 / Pinning

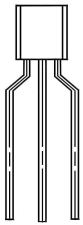

1 2 3

PIN1 : Base

PIN 2 : Collector

PIN 3 : Emitter

## 放大及印章代码 / hFE Classifications & Marking

见印章说明。See Marking Instructions.

**极限参数 / Absolute Maximum Ratings(Ta=25°C)**

参数 Parameter	符号 Symbol	数值 Rating	单位 Unit
Collector to Base Voltage	$V_{CBO}$	800	V
Collector to Emitter Voltage	$V_{CEO}$	500	V
Emitter to Base Voltage	$V_{EBO}$	9.0	V
Collector Current - Continuous	$I_C$	1.5	A
Collector Power Dissipation	$P_C$	1.0	W
Junction Temperature	$T_j$	150	°C
Storage Temperature Range	$T_{sag}$	-55~150	°C

**电性能参数 / Electrical Characteristics(Ta=25°C)**

参数 Parameter	符号 Symbol	测试条件 Test Conditions	最小值 Min	典型值 Typ	最大值 Max	单位 Unit
Collector to Base Breakdown Voltage	$V_{CBO}$	$I_C=100\mu A$ $I_E=0$	800			V
Collector to Emitter Breakdown Voltage	$V_{CEO}$	$I_C=1mA$ $I_B=0$	500			V
Emitter to Base Breakdown Voltage	$V_{EBO}$	$I_E=1mA$ $I_C=0$	9.0			V
Collector Cut-Off Current	$I_{CBO}$	$V_{CB}=800V$ $I_E=0$			0.1	mA
Collector cut-off current	$I_{CEO}$	$V_{CE}=500V$ $I_B=0$			0.1	mA
Emitter Base Cut-Off Current	$I_{EBO}$	$V_{EB}=9.0V$ $I_C=0$			0.1	mA
DC Current Gain	$h_{FE}$	$V_{CE}=5.0V$ $I_C=200mA$	30		40	
Collector to Emitter Saturation Voltage	$V_{CE(sat)}$	$I_C=1A$ $I_B=250mA$			0.8	V
Base to Emitter Saturation Voltage	$V_{BE(sat)}$	$I_C=1A$ $I_B=250mA$			1.2	V
Transition Frequency	$f_T$	$V_{CE}=10V$ $I_C=100mA$ $f=1.0MHz$	5.0			MHz
Fall time	$t_f$	$V_{CE}=5V$ $I_C=250mA$ (UI9600)			0.6	$\mu s$
Storage time	$t_s$				3.5	$\mu s$

电参数曲线图 / Electrical Characteristic Curve

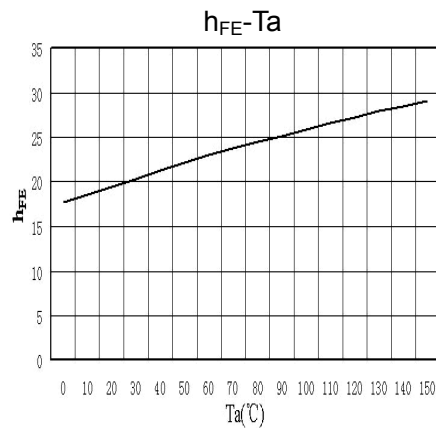
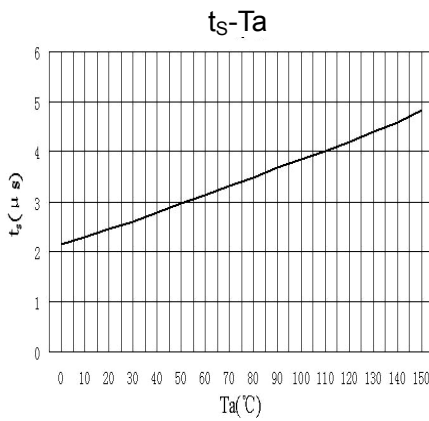
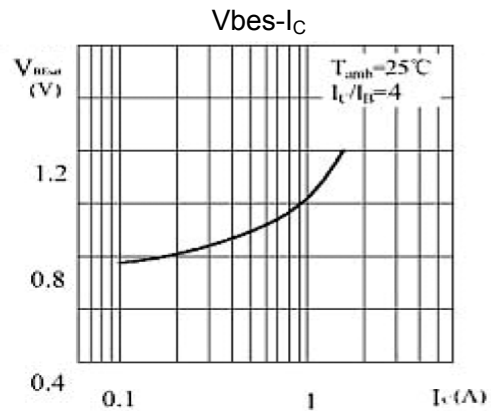
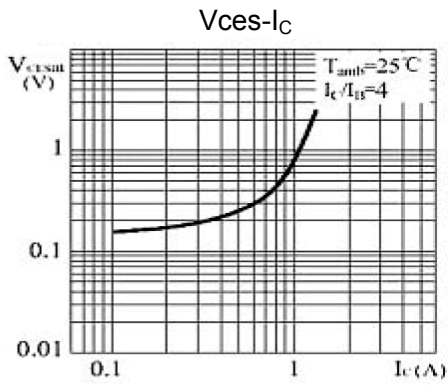
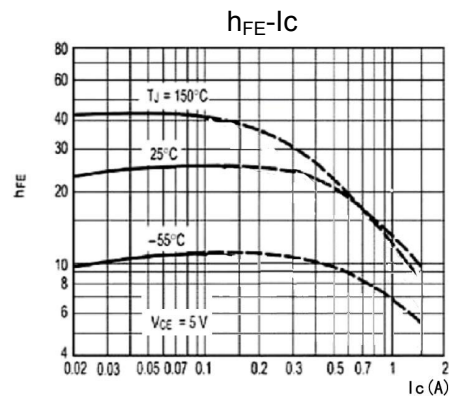
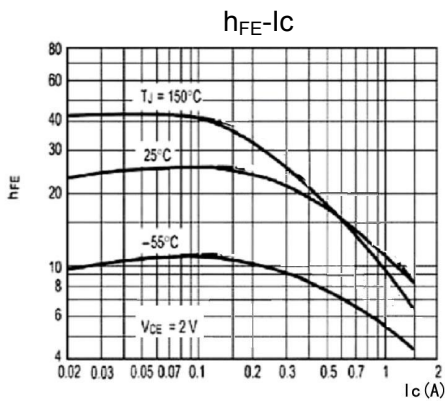
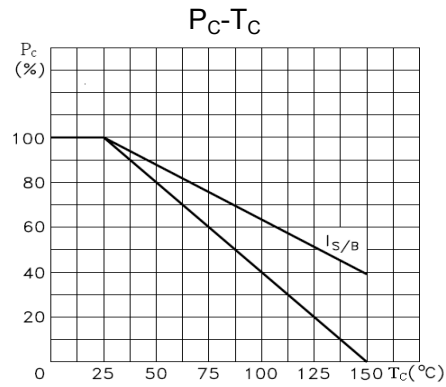
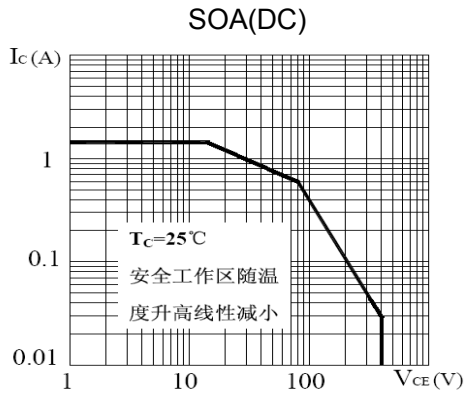

外形尺寸图 / Package Dimensions

T0-92

Unit:mm

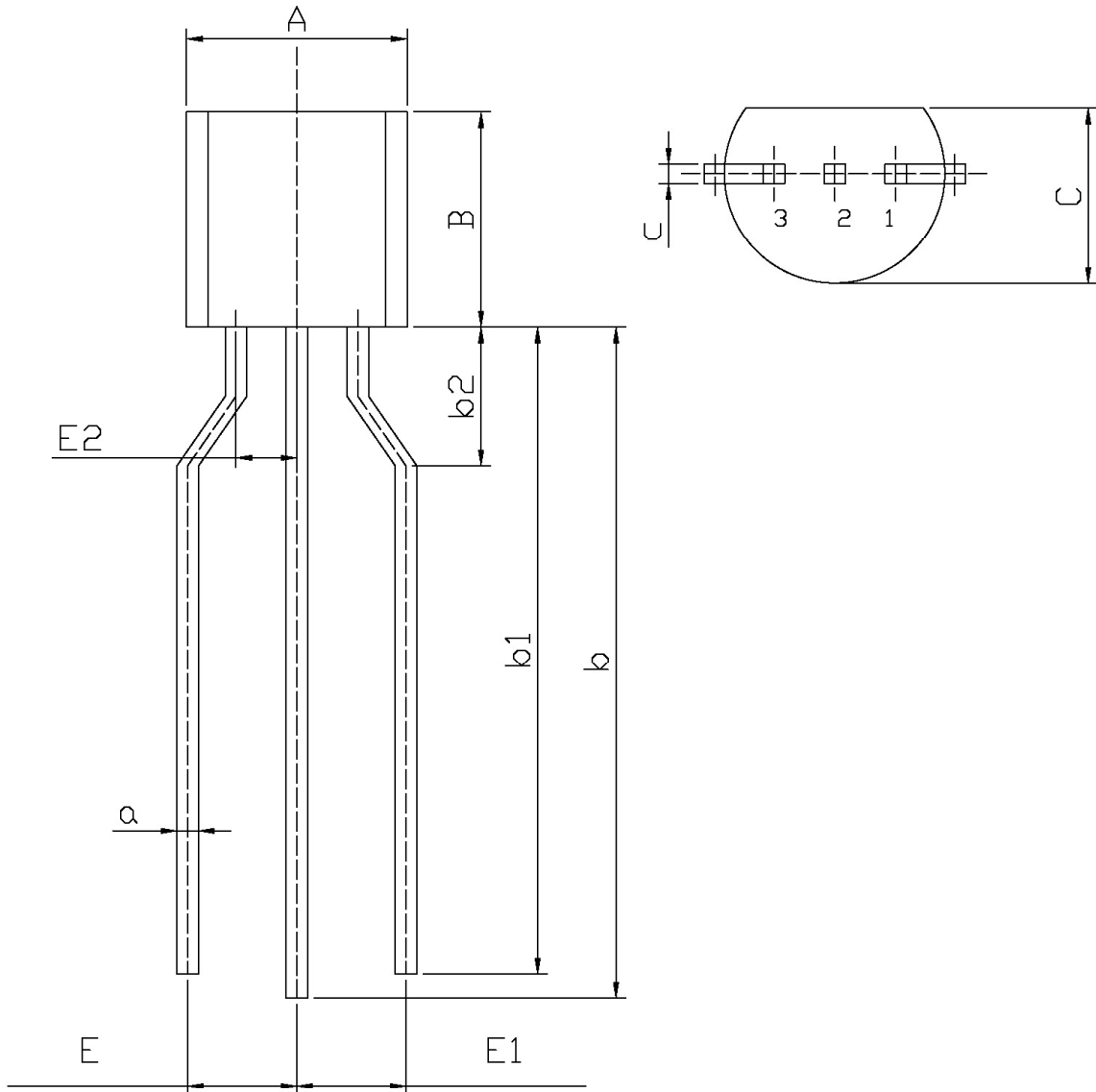

Symbol	Dimensions In Millimeters		Symbol	Dimensions In Millimeters	
	Min	Max		Min	Max
C	3.40	3.80	b2	2.0	3.0
c	0.30	0.50	E	2.4	2.8
A	4.40	4.80	E1	2.4	2.8
B	4.30	4.70	E2	1.22	1.32
b	13	15	a	0.40	0.60
b1	12.5	14.5			

印章说明 / Marking Instructions

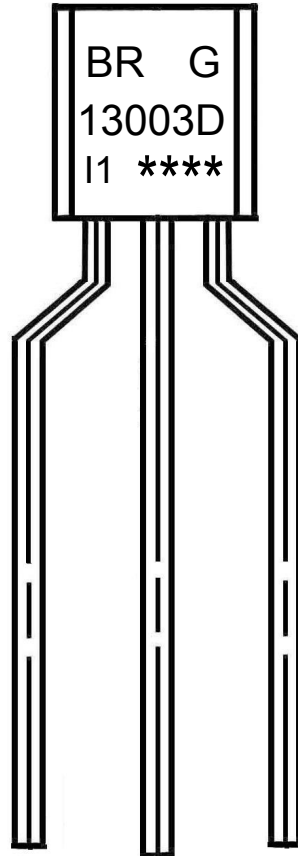

说明：

BR: 为公司代码

G : 为无卤产品代码

13003D : 为型号代码

I1: 规格代码

\*\*\*\* : 为生产批号代码，随生产批号变化。

Note:

BR: Company Code.

G: HF Product Code

13003D: Product Type.

I1: Specification Code.

\*\*\*\*: Lot No. Code,code change with Lot No.

**波峰焊温度曲线图(无铅) / Temperature Profile for Dip Soldering(Pb-Free)**

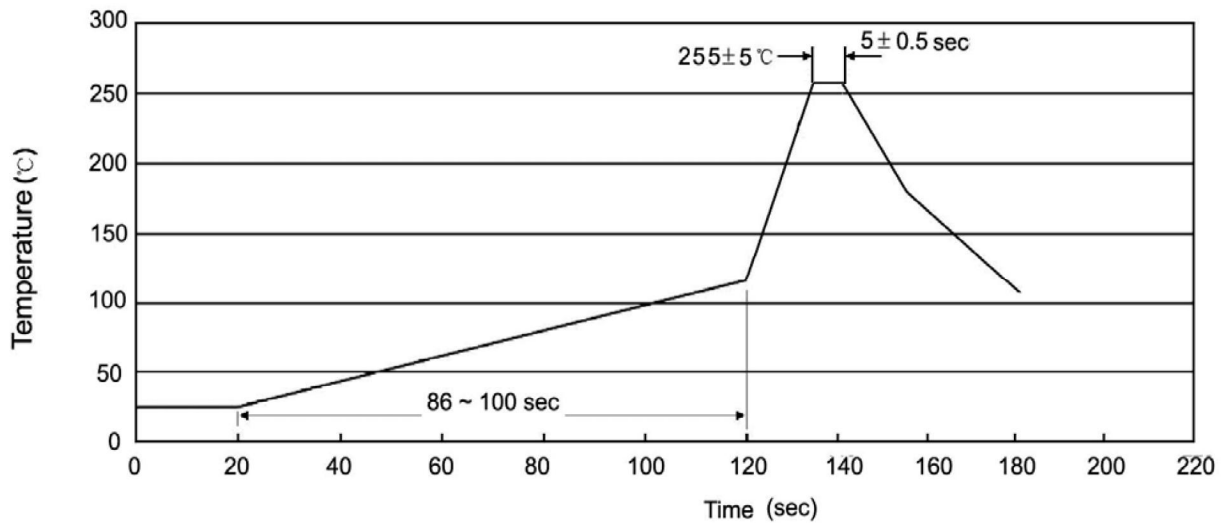

说明：

- 1、预热温度 25 ~ 150°C，时间 60 ~ 90sec;
- 2、峰值温度 255±5°C，时间持续为 5±0.5sec;
- 3、焊接制程冷却速度为 2 ~ 10°C/sec.

Note:

- 1.Preheating:25~150°C, Time:60~90sec.
- 2.Peak Temp.:255±5°C, Duration:5±0.5sec.
3. Cooling Speed: 2~10°C/sec.

**耐焊接热试验条件 / Resistance to Soldering Heat Test Conditions**

温度：270±5°C

时间：10±1 sec.

Temp:270±5°C

Time:10±1 sec

**包装规格 / Packaging SPEC.**

散件包装 / BULK

Package Type 封装形式	Units 包装数量					Dimension 包装尺寸 (unit: mm3)		
	Units/Bag 只/袋	Bags/Inner Box 袋/盒	Units/Inner Box 只/盒	Inner Boxes/Outer Box 盒/箱	Units/Outer Box 只/箱	Bag 袋	Inner Box 盒	Outer Box 箱
TO-92	1,000	10	10,000	5	50,000	135×190	237×172×102	560×245×195
	1,000	10	10,000	10	100,000	135×190	237×172×102	560×245×375

编带包装 / AMMO

Package Type 封装形式	Units 包装数量					Dimension 包装尺寸 (unit: mm3)	
	Units/tape 只/纸带	Tape/Inner Box 纸带/盒	Rows/Inner Box 纸带层/盒	Inner Boxes/Outer Box 盒/箱	Units/Outer Box 只/箱	Inner Box 盒	Outer Box 箱
TO-92	3,000	1	120	10	30,000	328×230×42	小箱 480×346×235, 大箱 547×407×268

**使用说明 / Notices**

编带尺寸 / Series Size Chart

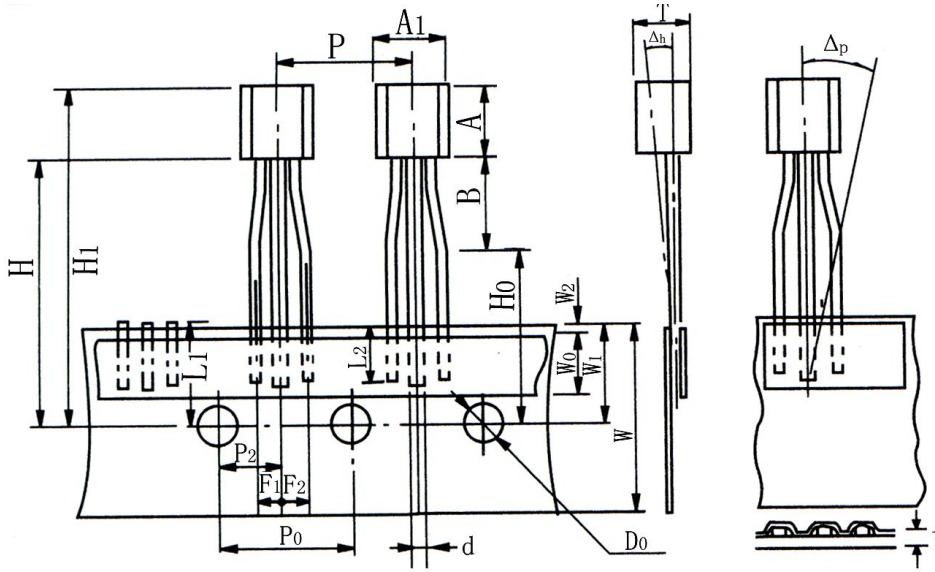

项 目	符合	数 值			备 注
		TO-92S	TO-92	TO-92L(M)	
元件宽度	$A_1$	4.2MAX	4.8MAX	5.1MAX	
元件高度	$A$	3.2MAX	4.7MAX	8.2MAX	
元件厚度	$T$	2.1MAX	3.7MAX	4.1MAX	
引线口径(方线)	$d$	0.45 典型值			
引线粘接宽度	$L_2$	2.5MIN			
元件间距	$P$	12.7±1.0			
输送孔中心间距	$P_0$	12.7±0.3			累积间距误差: ±1.0mm/20 只间隔
输送孔中心与引线中心间距	$P_2$	6.35±0.4			
相邻引线间距	$F_1F_2$	2.5 +0.45 -0.15			
元件歪斜度(1)	$\Delta h$	0±1.0			
纸带宽	$W$	18.0 + 1.0 -0.5			
胶粘纸宽	$W_0$	6.0±0.3			
输送孔定位	$W_1$	9.0±0.5			
粘纸与基纸间距	$W_2$	0.5MAX			
元件底部与纸带中心距离	$H$	19.0±0.5			
焊接平面高度	$H_0$	16.0±0.5			
元件顶部与纸带中心距离	$H_1$	32.25MAX			
输送孔直径	$D_0$	4.0±0.2			
总纸厚	$t$	0.5±0.1			
引线被切断后相对长度	$L_1$	11.0MAX			
元件歪斜度(2)	$\Delta P$	0±1.0			

## X-ON Electronics

Largest Supplier of Electrical and Electronic Components

*Click to view similar products for [Darlington Transistors](#) category:*

*Click to view products by [Blue Rocket](#) manufacturer:*

Other Similar products are found below :

[281287X](#) [SMMBT6427LT1G](#) [2N7371](#) [BDV64B](#) [JANTXV2N6287](#) [028710A](#) [SMMBTA64LT1G](#) [2N6350](#) [2SB1214-TL-E](#)  
[SMMBTA14LT1G](#) [SBSP52T1G](#) [NJVMJD117T4G](#) [Jantx2N6058](#) [2N6353](#) [LB1205-L-E](#) [500-00005](#) [2N6053](#) [NJVMJD112G](#) [Jan2N6350](#)  
[Jantx2N6352](#) [Jantx2N6350](#) [BULN2803LVS](#) [ULN2001N](#) [2SB1383](#) [2SB1560](#) [2SB852KT146B](#) [TIP112TU](#) [TIP122TU](#) [BCV27](#) [MMBTA13-](#)  
[TP](#) [MMBTA14-TP](#) [MMSTA28T146](#) [BSP50H6327XTSA1](#) [KSH122TF](#) [NTE2557](#) [NJVNJD35N04T4G](#) [TIP115](#) [MPSA29-D26Z](#) [MJD127T4](#)  
[FJB102TM](#) [BCV26E6327HTSA1](#) [BCV46E6327HTSA1](#) [BCV47E6327HTSA1](#) [BSP61H6327XTSA1](#) [BU941ZPFI](#) [2SB1316TL](#) [2SD1980TL](#)  
[NTE2350](#) [NTE245](#) [NTE246](#)