

描述 / Descriptions

TO-126F 塑封封装 PNP 半导体三极管。Silicon PNP transistor in a TO-126F Plastic Package.

特征 / Features

开关速度快。
high speed switching.

用途 / Applications

用于音频功率放大，小电流高速开关。
Low power audio amplifier, Low current, high speed switching applications.

内部等效电路 / Equivalent Circuit

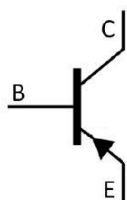

引脚排列 / Pinning



PIN1 : Emitter PIN 2 : Collector PIN 3 : Base

放大及印章代码 / h_{FE} Classifications & Marking

见印章说明。See Marking Instructions.

极限参数 / Absolute Maximum Ratings(Ta=25°C)

参数 Parameter	符号 Symbol	数值 Rating	单位 Unit
Collector to Base Voltage	V_{CBO}	-100	V
Collector to Emitter Voltage	V_{CEO}	-80	V
Emitter to Base Voltage	V_{EBO}	-7.0	V
Collector Current - Continuous	I_C	-3.0	A
Collector Current - Continuous	I_{CP}	-6.0	A
Base Current - Continuous	I_B	-1.0	A
Collector Power Dissipation	P_C	1.5	W
Collector Power Dissipation	$P_C(T_c=25^\circ\text{C})$	12.5	W
Junction Temperature	T_j	150	°C
Storage Temperature Range	T_{stg}	-55~150	°C

电性能参数 / Electrical Characteristics(Ta=25°C)

参数 Parameter	符号 Symbol	测试条件 Test Conditions	最小值 Min	典型值 Typ	最大值 Max	单位 Unit
Collector to Emitter Breakdown Voltage	V_{CEO}	$I_C=-10\text{mA}$ $I_B=0$	-80			V
Collector Cut-Off Current	I_{CBO}	$V_{CB}=-100\text{V}$ $I_E=0$			-0.1	μA
Emitter Cut-Off Current	I_{EBO}	$V_{EB}=-7.0\text{V}$ $I_C=0$			-0.1	μA
DC Current Gain	$h_{FE(1)}$	$V_{CE}=-1.0\text{V}$ $I_C=-100\text{mA}$	50		300	
	$h_{FE(2)}$	$V_{CE}=-1.0\text{V}$ $I_C=-500\text{mA}$	30			
	$h_{FE(3)}$	$V_{CE}=-1.0\text{V}$ $I_C=-1.5\text{A}$	12			
Collector to Emitter Saturation Voltage	$V_{CE(sat)(1)}$	$I_C=-500\text{mA}$ $I_B=-50\text{mA}$			-0.3	V
	$V_{CE(sat)(2)}$	$I_C=-1.5\text{A}$ $I_B=-150\text{mA}$			-0.9	V
	$V_{CE(sat)(3)}$	$I_C=-3.0\text{A}$ $I_B=-600\text{mA}$			-1.7	V
Base to Emitter Saturation Voltage	$V_{BE(sat)(1)}$	$I_C=-1.5\text{A}$ $I_B=-150\text{mA}$			-1.5	V
	$V_{BE(sat)(2)}$	$I_C=-3.0\text{A}$ $I_B=-600\text{mA}$			-2.0	V
Base to Emitter On Voltage	$V_{BE(on)}$	$V_{CE}=-1.0\text{V}$ $I_C=-500\text{mA}$			-1.2	V
Transition Frequency	f_T	$V_{CE}=-10\text{V}$ $I_C=-100\text{mA}$	50			MHz
Reverse Transfer Capacitance	C_{ob}	$V_{CB}=-10\text{V}$ $f=0.1\text{MHz}$			50	pF

电参数曲线图 / Electrical Characteristic Curve

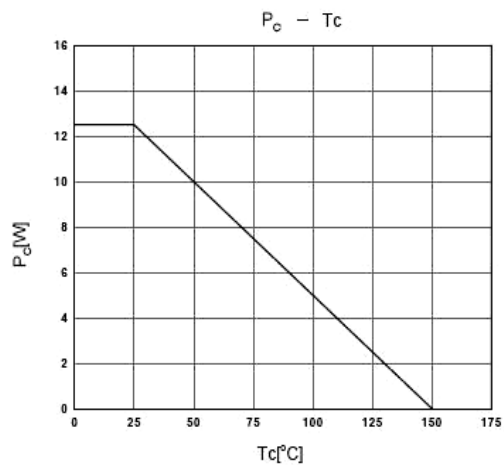
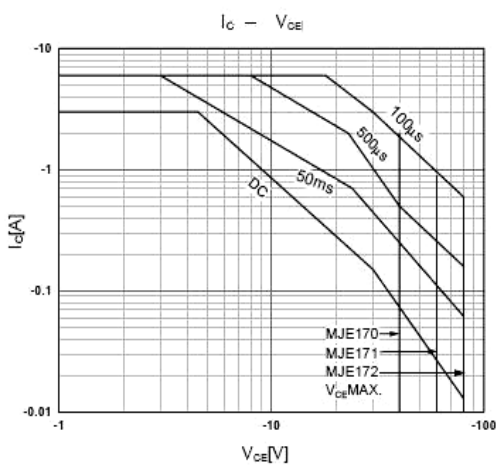
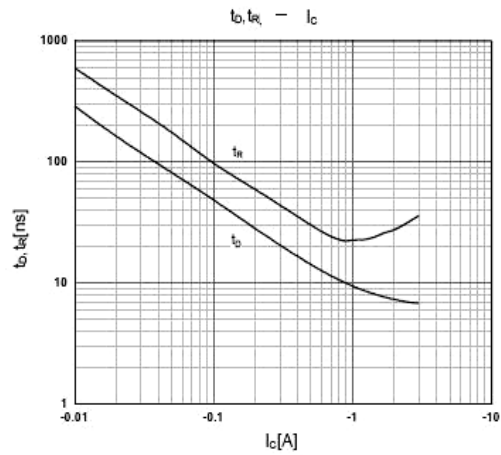
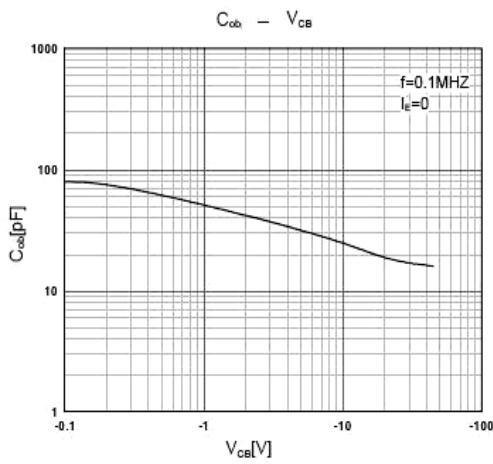
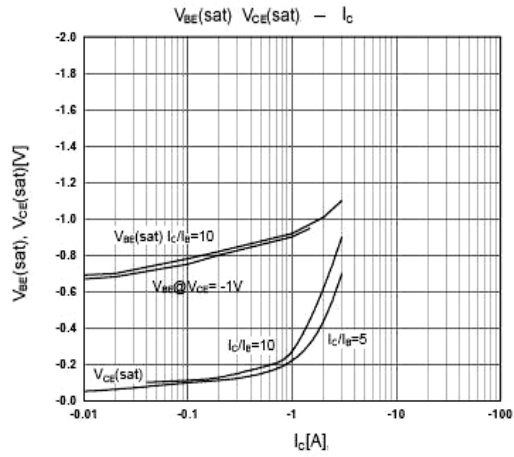
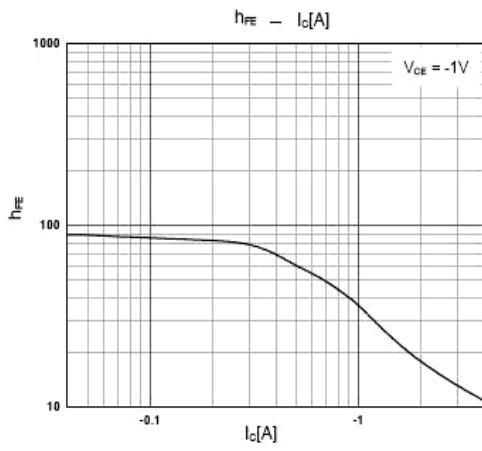

外形尺寸图 / Package Dimensions

T0-126F

单位: mm

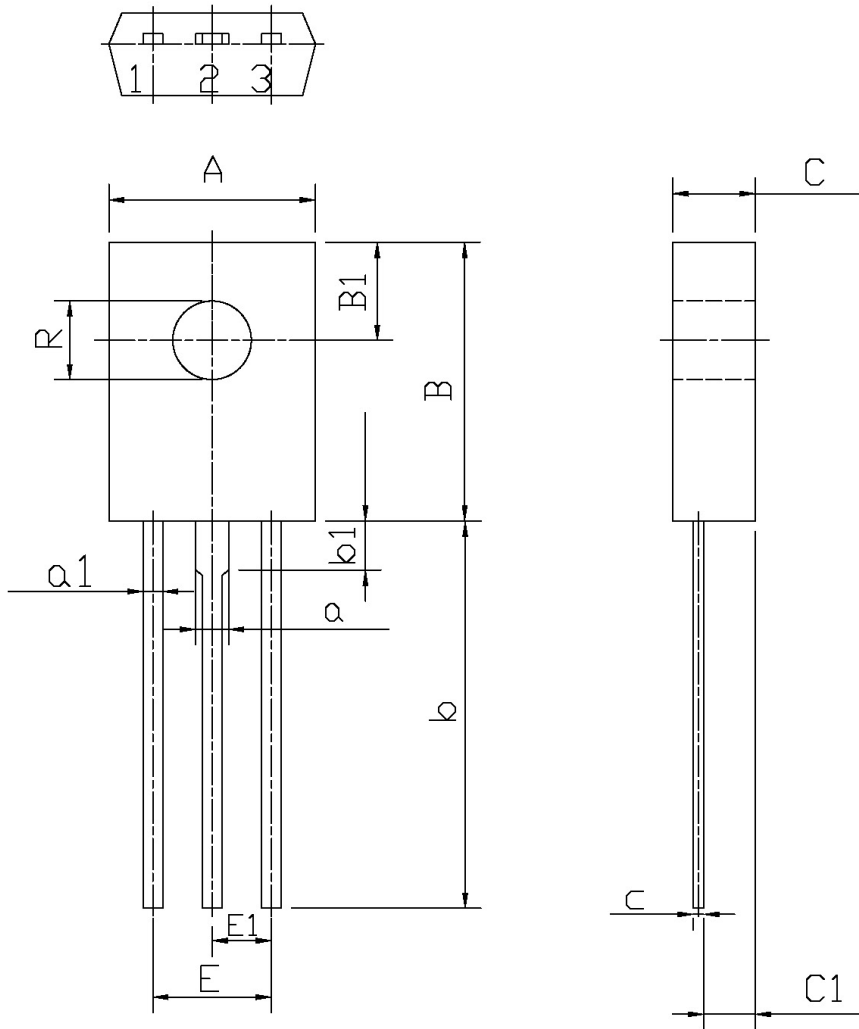

Symbol	Dimensions In Millimeters		Symbol	Dimensions In Millimeters	
	Min	Max		Min	Max
A	7.8	8.2	a1	0.66	0.86
B	10.8	11.2	E	4.4	4.8
B1	3.8	4.2	C	3.1	3.3
R	2.95	3.15	C1	1.9	2.1
b	14	16	c	0.3	0.6
b1	1.9		a	1.27	
E1	2.1	2.5			

印章说明 / Marking Instructions

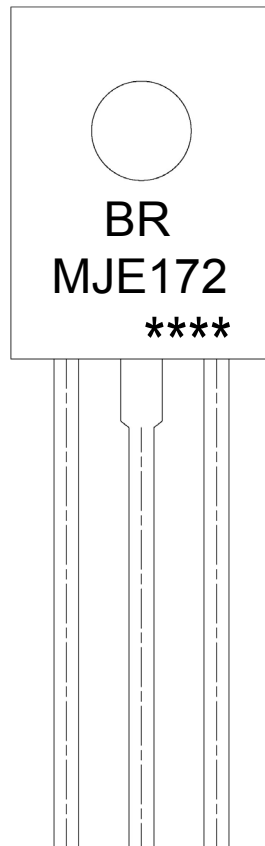

说明：

BR： 为公司代码

MJE172： 为产品型号

****： 为生产批号代码，随生产批号变化。

Note:

BR: Company Code

MJE172: Product Type.

****: Lot No. Code, code change with Lot No.

波峰焊温度曲线图(无铅) / Temperature Profile for Dip Soldering(Pb-Free)



说明：

- 1、预热温度 25 ~ 150°C，时间 60 ~ 90sec；
- 2、峰值温度 255±5°C，时间持续为 5±0.5sec；
- 3、焊接制程冷却速度为 2 ~ 10°C/sec.

Note:

- 1.Preheating:25~150°C, Time:60~90sec.
- 2.Peak Temp.:255±5°C, Duration:5±0.5sec.
3. Cooling Speed: 2~10°C/sec.

耐焊接热试验条件 / Resistance to Soldering Heat Test Conditions

温度：270±5°C

时间：10±1 sec.

Temp.:270±5°C

Time:10±1 sec

包装规格 / Packaging SPEC.

散件包装 / BULK

Package Type 封装形式	Units 包装数量					Dimension 包装尺寸 (unit: mm ³)		
	Units/Tube 只/套管	Tubes/Inner Box 套管/盒	Units/Inner Box 只/盒	Inner Boxes/Outer Box 盒/箱	Units/Outer Box 只/箱	Tube 套管	Inner Box 盒	Outer Box 箱
TO-126/F	500	6	3,000	5	15,000	135×190	237×172×102	560×245×195

套管包装 / TUBE

Package Type 封装形式	Units 包装数量					Dimension 包装尺寸 (unit: mm ³)		
	Units/Tube 只/套管	Tubes/Inner Box 套管/盒	Units/Inner Box 只/盒	Inner Boxes/Outer Box 盒/箱	Units/Outer Box 只/箱	Tube 套管	Inner Box 盒	Outer Box 箱
TO-126/F	65	26	1,690	5	8,450	532×31×5.6	555×164×50	575×290×180

使用说明 / Notices

X-ON Electronics

Largest Supplier of Electrical and Electronic Components

Click to view similar products for [Bipolar Transistors - BJT category](#):

Click to view products by [Blue Rocket manufacturer](#):

Other Similar products are found below :

[BC559C](#) [MCH4017-TL-H](#) [MMBT-2369-TR](#) [BC546/116](#) [NJVMJD148T4G](#) [NTE16](#) [NTE195A](#) [IMX9T110](#) [2N4401-A](#) [2N4403](#) [2N6728](#)
[2SA1419T-TD-H](#) [2SA2126-E](#) [2SB1204S-TL-E](#) [FMC5AT148](#) [2N2369ADCSM](#) [2N2907A](#) [2N3904-NS](#) [2N5769](#) [2SC4618TLN](#) [CPH6501-](#)
[TL-E](#) [MCH4021-TL-E](#) [Jantx2N5416](#) [US6T6TR](#) [BAX18/A52R](#) [BC556/112](#) [IMZ2AT108](#) [MMST8098T146](#) [UMX21NTR](#) [MCH6102-TL-E](#)
[TTA1452B,S4X\(S](#) [2N3879](#) [NTE13](#) [NTE282](#) [NTE323](#) [NTE350](#) [NTE81](#) [JANTX2N2920L](#) [JANTX2N3735](#) [JANSR2N2222AUB](#)
[CMLT3946EG TR](#) [SNSS40600CF8T1G](#) [CMLT3906EG TR](#) [GRP-DATA-JANS2N2907AUB](#) [GRP-DATA-JANS2N2222AUA](#)
[MMDT3946FL3-7](#) [2N4240](#) [JANS2N3019](#) [MSB30KH-13](#) [2N2221AUB](#)