

## 描述 / Descriptions

TO-3P 塑封封装 NPN 半导体三极管。Silicon NPN transistor in a TO-3P Plastic Package.

## 特征 / Features

用于 100W 高保真音频功率输出，与 NJW0302GC 互补。

Recommend for 100W high fidelity audio frequency amplifier output stage, Complementary to NJW0302GC.

## 用途 / Applications

用于一般功率放大。

Power amplifier applications.

## 内部等效电路 / Equivalent Circuit

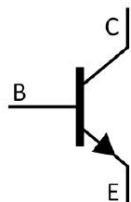

## 引脚排列 / Pinning

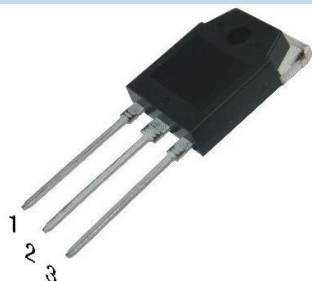

PIN1 : Base

PIN 2 : Collector

PIN 3 : Emitter

## 放大及印章代码 / $h_{FE}$ Classifications & Marking

见印章说明。See Marking Instructions.

**极限参数 / Absolute Maximum Ratings(Ta=25°C)**

参数 Parameter	符号 Symbol	数值 Rating	单位 Unit
Collector to Base Voltage	$V_{CBO}$	360	V
Collector to Emitter Voltage	$V_{CEO}$	360	V
Emitter to Base Voltage	$V_{EBO}$	5	V
Collector Current - Continuous	$I_C$	15	A
Peak Collector Current	$I_{Cp}$	30	A
Base Current	$I_B$	1.5	A
Collector Power Dissipation	$P_C$	150	W
Junction Temperature	$T_j$	150	°C
Storage Temperature Range	$T_{stg}$	-55~150	°C

**电性能参数 / Electrical Characteristics(Ta=25°C)**

参数 Parameter	符号 Symbol	测试条件 Test Conditions	最小值 Min	典型值 Typ	最大值 Max	单位 Unit
Collector to Emitter Breakdown Voltage	$V_{CEO}$	$I_C=50mA$ $I_E=0$	360			V
Collector Cut-Off Current	$I_{CBO}$	$V_{CB}=230V$ $I_E=0$			5	μA
Emitter Cut-Off Current	$I_{EBO}$	$V_{EB}=5.0V$ $I_C=0$			5	μA
DC Current Gain	$h_{FE(1)}$	$V_{CE}=5.0V$ $I_C=1.0A$	55		160	
	$h_{FE(2)}$	$V_{CE}=5.0V$ $I_C=7.0A$	35	80		
Collector to Emitter Saturation Voltage	$V_{CE(sat)}$	$I_C=8.0A$ $I_B=0.8A$		0.3	3.0	V
Base to Emitter Voltage	$V_{BE}$	$V_{CE}=5.0V$ $I_C=7.0A$		1.0	1.5	V
Transition Frequency	$f_T$	$I_C=1.0A$ $V_{CE}=5.0V$		30		MHz
Collector output capacitance	$C_{ob}$	$V_{CB}=10V$ $f=1.0MHz$ $I_E=0$		200		pF

电参数曲线图 / Electrical Characteristic Curve

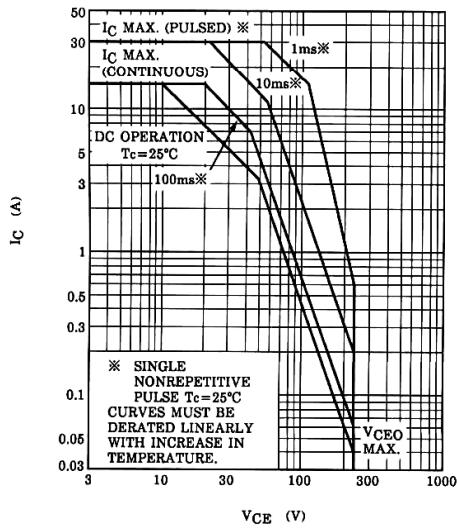
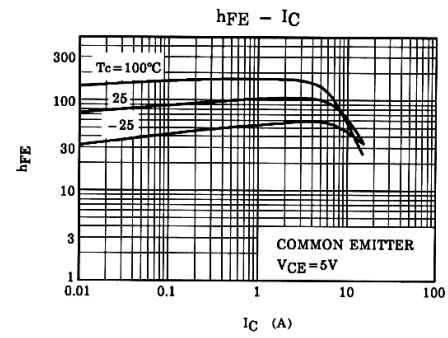
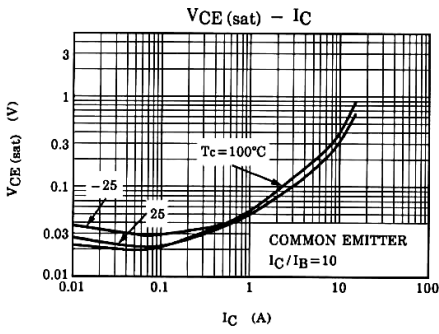
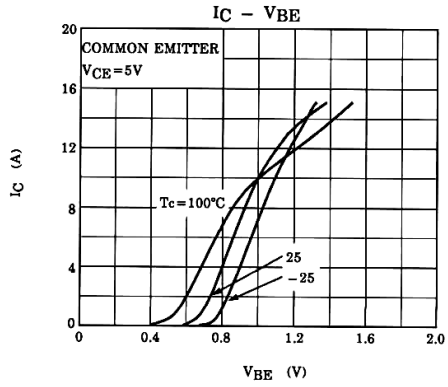
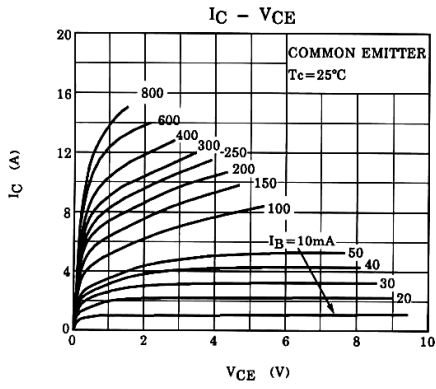

外形尺寸图 / Package Dimensions

TO-3P

单位: mm

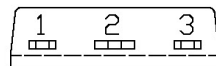
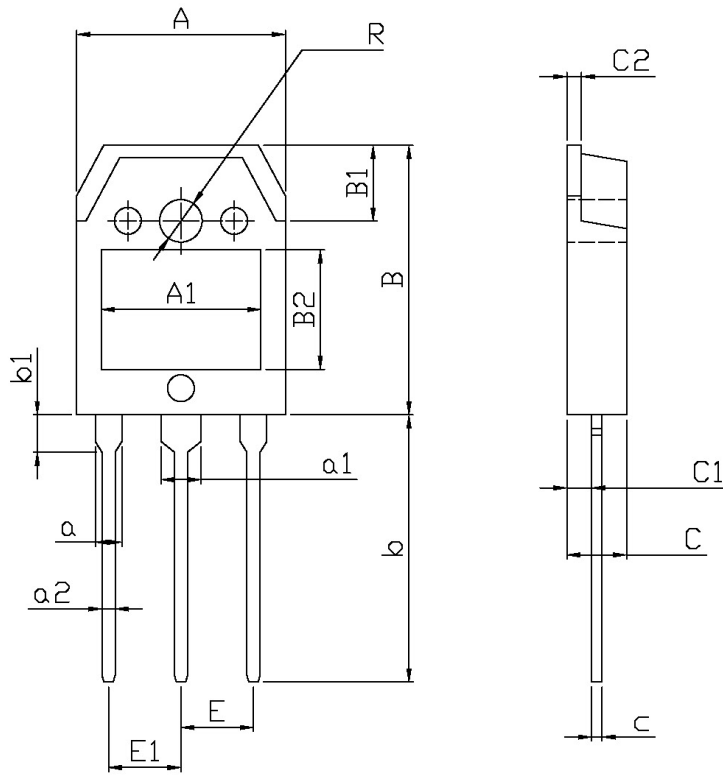

Symbol	Dimensions In Millimeters		Symbol	Dimensions In Millimeters	
	Min	Max		Min	Max
A	15.4	16.0	a2	0.8	1.2
R	3.1	3.5	E	5.45	
B	19.8	20.8	E1	5.45	
B1	5.5	5.9	C	4.3	4.7
B2	9.0		C1	1.2	1.6
A1	12.0		C2	1.4	1.6
b	19.6	20.6	c	0.5	0.7
b1	3.0	3.4			
a	1.8	2.2			
a1	2.8	3.2			

## 印章说明 / Marking Instructions

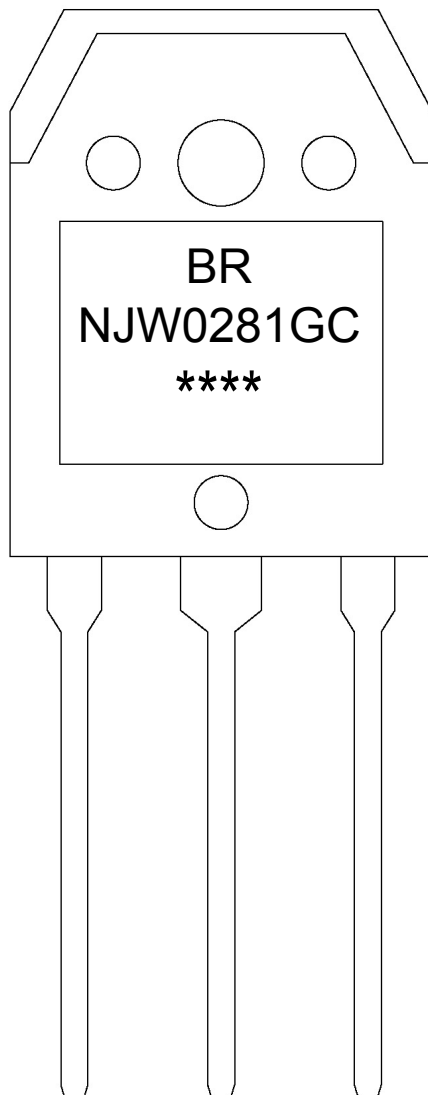

说明：

BR： 为公司代码

NJW0281GC： 为产品型号

\*\*\*\*： 为生产批号代码，随生产批号变化。

Note:

BR: Company Code.

NJW0281GC: Product Type.

\*\*\*\*: Lot No. Code, code change with Lot No.

**波峰焊温度曲线图(无铅) / Temperature Profile for Dip Soldering(Pb-Free)**

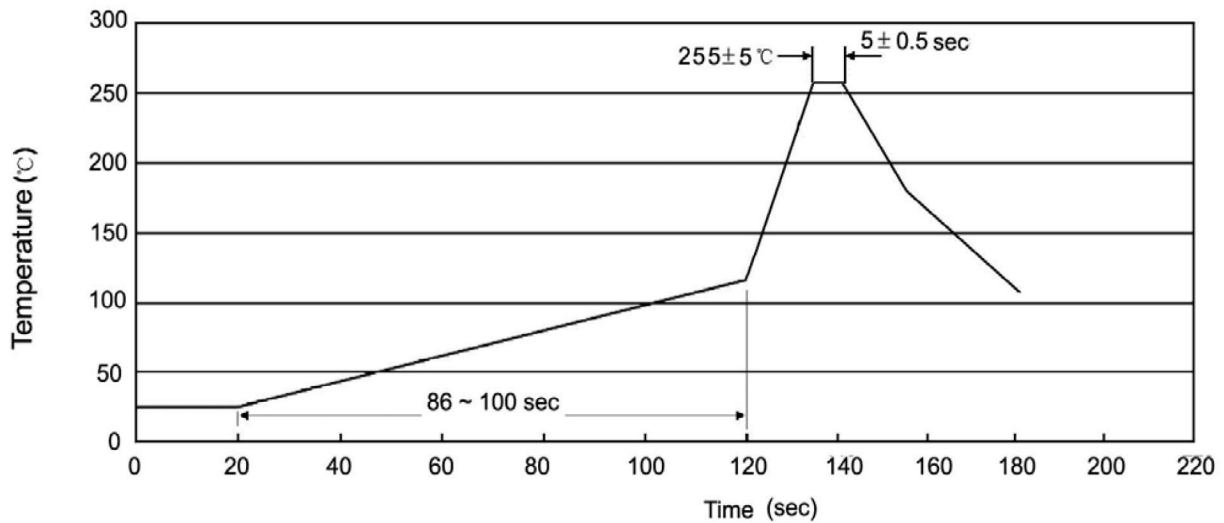

说明：

- 1、预热温度 25 ~ 150°C，时间 60 ~ 90sec;
- 2、峰值温度 255±5°C，时间持续为 5±0.5sec;
- 3、焊接制程冷却速度为 2 ~ 10°C/sec.

Note:

- 1.Preheating:25~150°C, Time:60~90sec.
- 2.Peak Temp.:255±5°C, Duration:5±0.5sec.
3. Cooling Speed: 2~10°C/sec.

**耐焊接热试验条件 / Resistance to Soldering Heat Test Conditions**

温度：270±5°C

时间：10±1 sec.

Temp.:270±5°C

Time:10±1 sec

**包装规格 / Packaging SPEC.**

套管包装 / TUBE

Package Type 封装形式	Units 包装数量					Dimension 包装尺寸 (unit: mm <sup>3</sup> )		
	Units/Tube 只/套管	Tubes/Inner Box 套管/盒	Units/Inner Box 只/盒	Inner Boxes/Outer Box 盒/箱	Units/Outer Box 只/箱	Tube 套管	Inner Box 盒	Outer Box 箱
TO-3P	30	15	450	5	2250	497.5×46×8	555×164×50	575×290×180

**使用说明 / Notices**

## X-ON Electronics

Largest Supplier of Electrical and Electronic Components

*Click to view similar products for [Bipolar Transistors - BJT category](#):*

*Click to view products by [Blue Rocket manufacturer](#):*

Other Similar products are found below :

[BC559C](#) [MCH4017-TL-H](#) [MMBT-2369-TR](#) [BC546/116](#) [NJVMJD148T4G](#) [NTE16](#) [NTE195A](#) [IMX9T110](#) [2N4401-A](#) [2N4403](#) [2N6728](#)  
[2SA1419T-TD-H](#) [2SA2126-E](#) [2SB1204S-TL-E](#) [FMC5AT148](#) [2N2369ADCSM](#) [2N2907A](#) [2N3904-NS](#) [2N5769](#) [2SC4618TLN](#) [CPH6501-](#)  
[TL-E](#) [MCH4021-TL-E](#) [Jantx2N5416](#) [US6T6TR](#) [BAX18/A52R](#) [BC556/112](#) [IMZ2AT108](#) [MMST8098T146](#) [UMX21NTR](#) [MCH6102-TL-E](#)  
[TTA1452B,S4X\(S](#) [2N3879](#) [NTE13](#) [NTE282](#) [NTE323](#) [NTE350](#) [NTE81](#) [JANTX2N2920L](#) [JANTX2N3735](#) [JANSR2N2222AUB](#)  
[CMLT3946EG TR](#) [SNSS40600CF8T1G](#) [CMLT3906EG TR](#) [GRP-DATA-JANS2N2907AUB](#) [GRP-DATA-JANS2N2222AUA](#)  
[MMDT3946FL3-7](#) [2N4240](#) [JANS2N3019](#) [MSB30KH-13](#) [2N2221AUB](#)